

# **AX SERIES**

Integratable Audio  
& Video Security



**Versatile Intercom Communication  
for any Security Demand**



# COMPLETE SECURITY

Over half of all medium to large sized business establishments **limit access** into their building.

*- Bureau of Labor Statistics*



# AX SERIES

gives you the  
power to...

- **CONTROL**

entry security and  
regulate access  
into a building

- **COMMUNICATE**

easily and efficiently  
while keeping your  
facility secure

- **CONFIRM**

identity with crisp  
audio and clear,  
up-close video



COMMERCIAL



HEALTHCARE



EDUCATIONAL

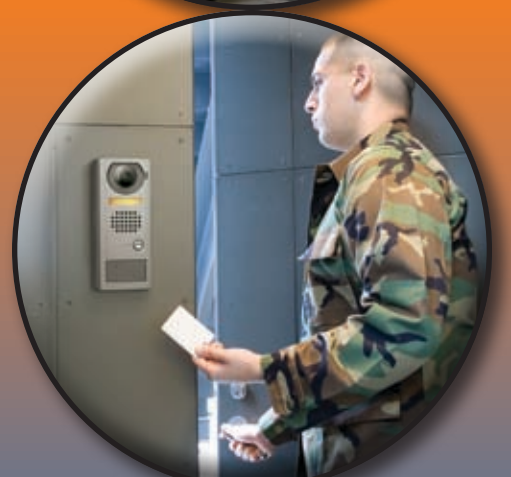

GOVERNMENT



# SYSTEM LAYOUT: STANDARD

CEU (AX-084C shown)

## AX Series: Versatile System



Flexible system allows expansion up to 8 master stations and 120 door/sub/adaptor stations for complete building security.

## Protect Remote Areas

Reduce exposure to risk in remote locations by adding door stations to parking garages, stanchions, gates, etc.

CAT-5e

IE-SSR



## Monitor Interior Doorways

Secure access to restricted areas within a building by using the video door stations at interior locations.

AX-DVF



CAT-5e

## Safeguard All Exterior Entrances

Protect front and rear doorways, loading docks, and service entries with video door stations.

CAT-5e

## Scan Monitoring

Systematically listen to programmed door or sub stations, saving on labor and ensuring security.

CAT-5e

## Vandal Resistant Door Stations

Enhance overall building security with vandal resistant video door stations at perimeter gates and outdoor entrances.

CAT-5e

### Door Strikes & Magnetic Door Locks

Door strikes or magnetic door locks can be controlled by the master stations.  
*(Requires additional wire)*

### Selective Calling

Use the master stations to selectively call all other master, door, and sub stations throughout the facility.

### All Call & Group Call

Master stations have the ability to use All Call and Group Call features between other master stations.

CAT-5e

CAT-5e

CAT-5e

CAT-5e

AX-8M

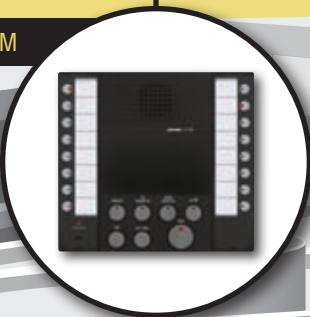

AX-8MV



AX-8MV



AX-DV



AX-AN



AX-DM



AX-DVF



### Mullion Mount Door Station

Mullion mount door stations are available to use where video identification is not required.

**IMPORTANT:** Diagram is for illustrative purposes only. System wiring may vary by installation! Refer to instruction manual for actual wire count & installation directions.

# SYSTEM LAYOUT: INTEGRATED

CEU (AX-248C shown)

## AX Series: Mainstream Integration



Integrate the AX Series into existing security components including CCTV systems, electronic access control, and telephone transfer.

Telephone wire

Viking Model K-1900-5 Programmable Dialer \*



Outside telephone line

CAT-5e CAT-5e CAT-5e

## CCTV Cameras

Monitor parking garages and other remote areas by integrating with a CCTV system.

IE-SSR



CCTV Camera \*



AXW-AZ



CAT-5e

Variable wire  
(determined by product used)

## Electronic Access Control

Authorize or deny access into a building, or areas within a building, using the electronic access control function.  
*(May require additional wire)*

## Keyless Entry

HID® embedded door stations are ideal for any location where keyless entry is wanted or required. *(Host controller required for card readers. Not supplied by Aiphone)*

AXW-AVR



Variable wire  
(determined by product used)

## Increase Wire Distance

If a perimeter gate exceeds 980 ft., use the AXW-AVT and AXW-AVR along with fiber optic or other devices to extend the distance.  
*(Please see page 11 for a current list of compatible devices)*

## Utilize Infrastructure

The AXW-AVT and AXW-AVR allows the use of a facility's **existing** technologies and wiring systems.

AXW-AVT



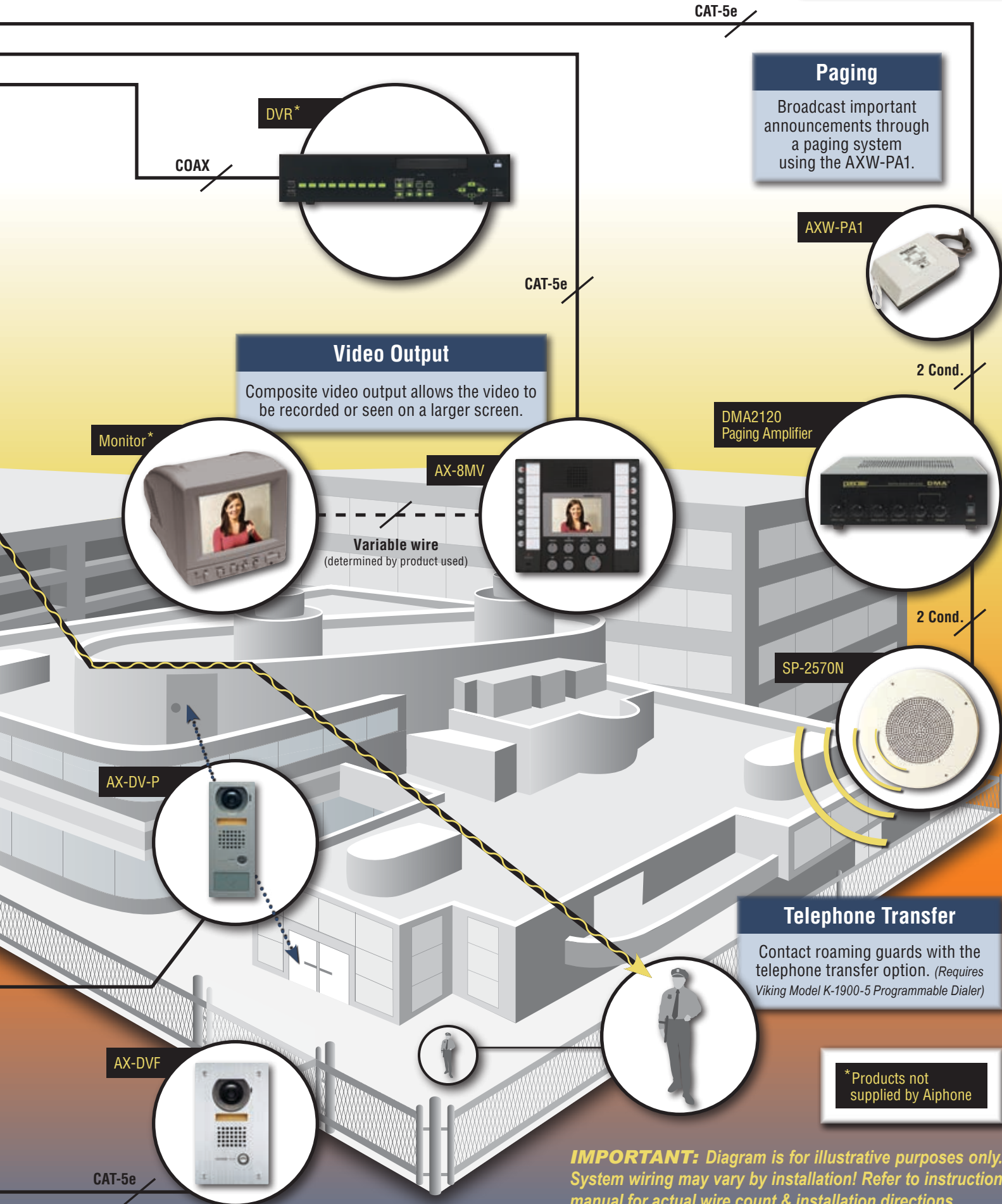

### Paging

Broadcast important announcements through a paging system using the AXW-PA1.

AXW-PA1



2 Cond.

DMA2120  
Paging Amplifier



2 Cond.

SP-2570N

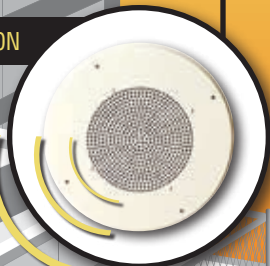

### Telephone Transfer

Contact roaming guards with the telephone transfer option. (Requires Viking Model K-1900-5 Programmable Dialer)

\*Products not supplied by Aiphone

**IMPORTANT:** Diagram is for illustrative purposes only. System wiring may vary by installation! Refer to instruction manual for actual wire count & installation directions.



# System Hardware Example

## Basic Installation

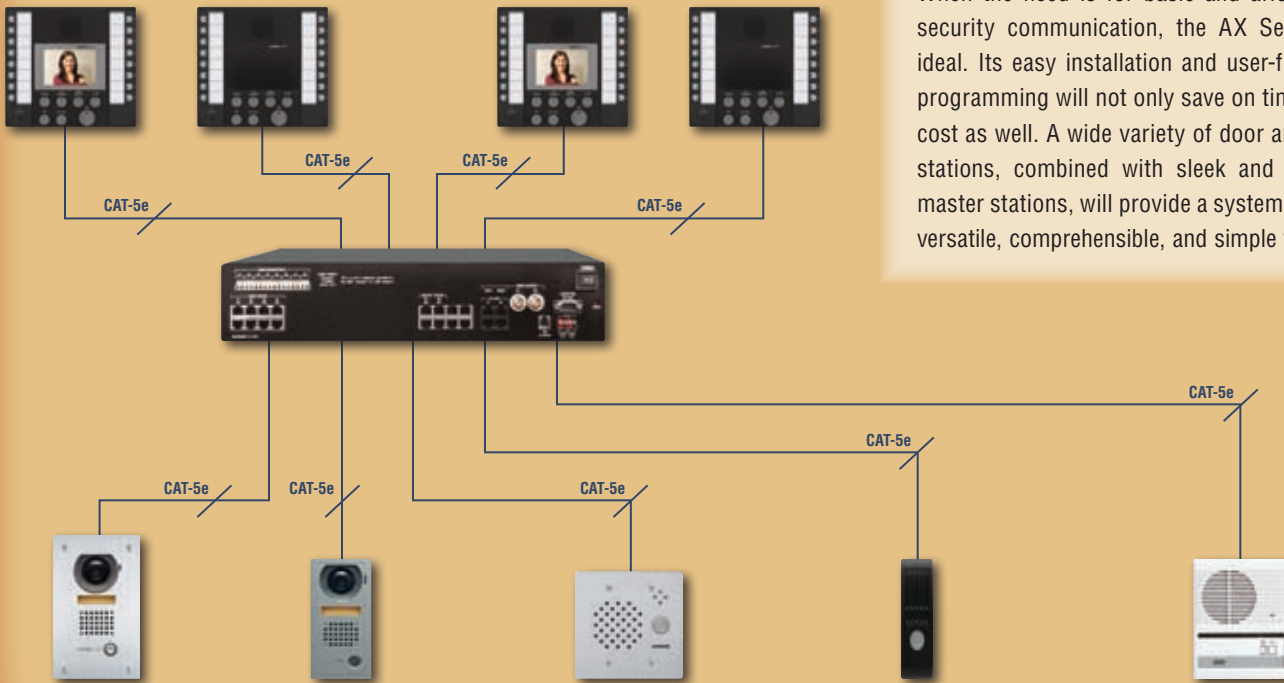

When the need is for basic and affordable security communication, the AX Series is ideal. Its easy installation and user-friendly programming will not only save on time, but cost as well. A wide variety of door and sub stations, combined with sleek and sturdy master stations, will provide a system that is versatile, comprehensible, and simple to use.

**NOTE:** Power supplies not shown. For a fully integrated installation, see the system software example on the next page.

# System Software

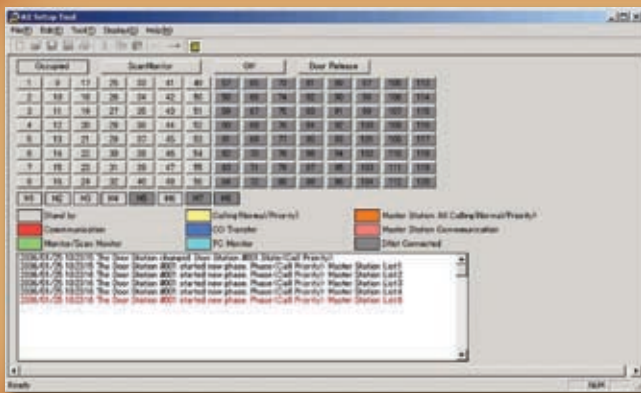

Features and functions are programmed using the custom software, included with the CEU. It is intuitive to use and allows you to set individual door stations' call-in length (10 seconds to 10 minutes, or infinite), call-in priority levels, scan monitoring inclusion, and door release relay activation and timing. In addition, the software features an easy to use interface for gathering log data, setting the communication method at the master (VOX or PTT), and data up/down loading.

# System Wiring Diagram

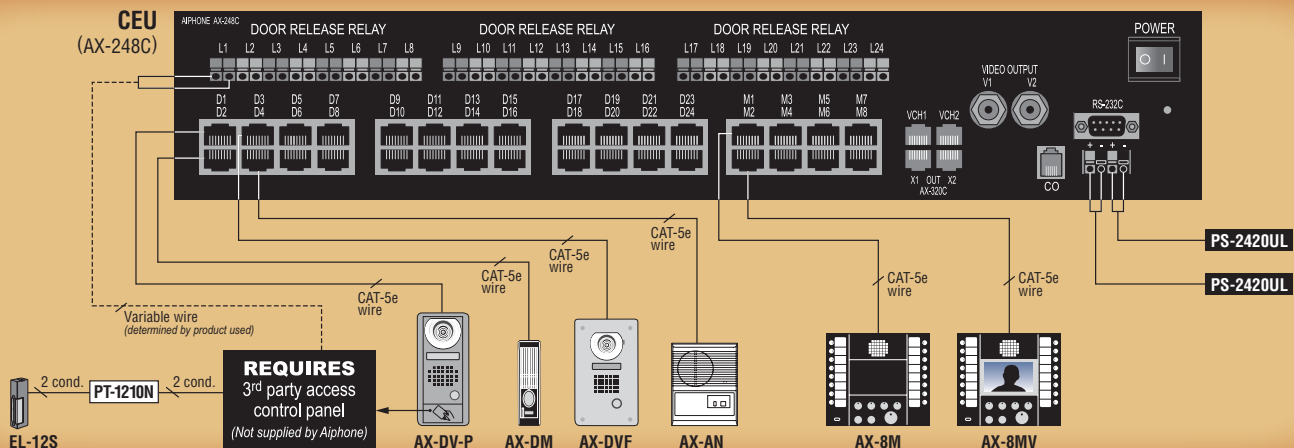

**REQUIRES**  
3<sup>rd</sup> party access control panel  
(Not supplied by Alphone)



# System Integration Example

## Fully Integrated Installation

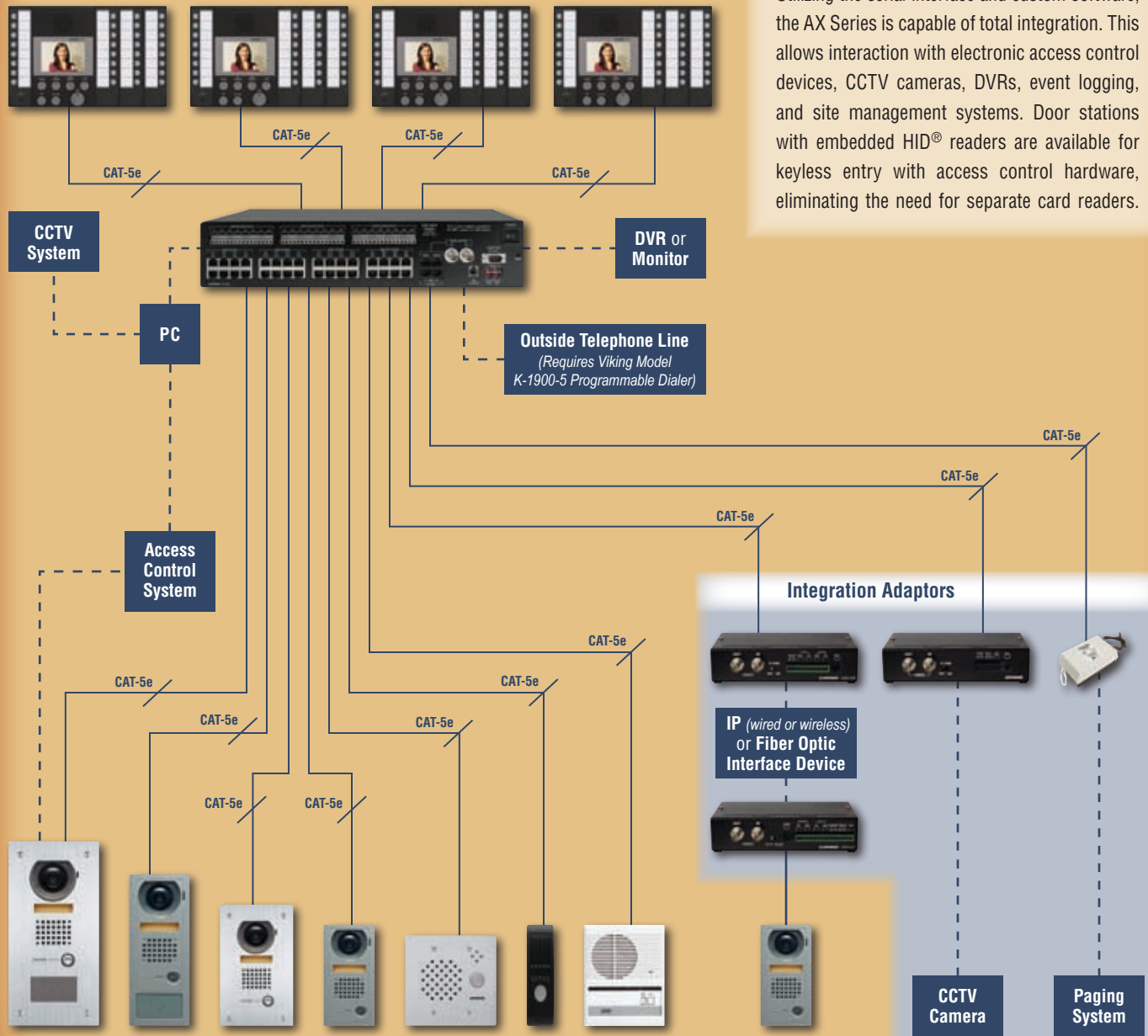

Utilizing the serial interface and custom software, the AX Series is capable of total integration. This allows interaction with electronic access control devices, CCTV cameras, DVRs, event logging, and site management systems. Door stations with embedded HID® readers are available for keyless entry with access control hardware, eliminating the need for separate card readers.

NOTE: Power supplies not shown.

## Integrated Wiring Diagram

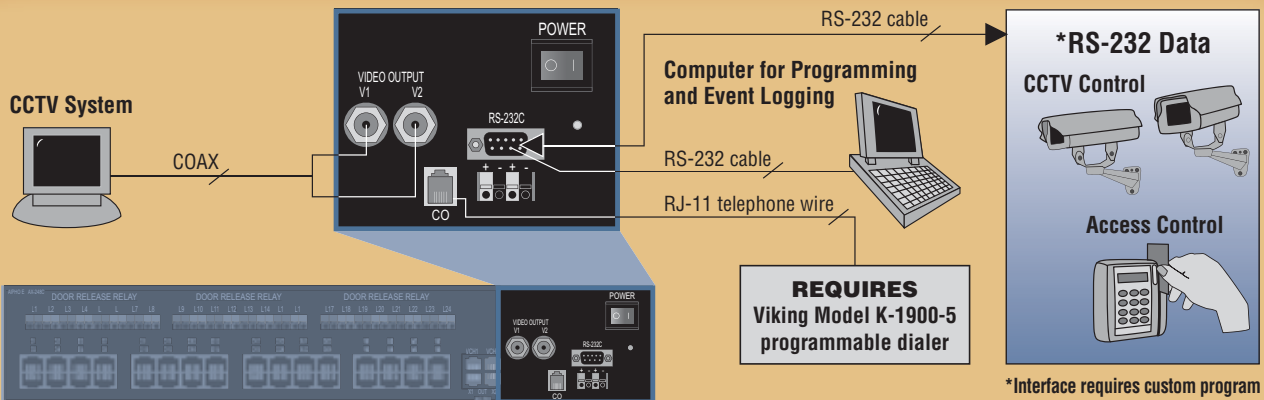

\*Interface requires custom program (Not supplied by Aiphone)

# Central Exchange Unit



**AX-084C** (Shown)  
Central Exchange Unit for 8 doors and 4 masters

**AX-248C**  
Central Exchange Unit for 24 doors and 8 masters

**AX-320C**  
Add-on Exchange Unit for 32 doors

- RJ-45 connectors for master and door stations
- Composite video output (BNC)
- RS-232 serial output
- Selective door release (Programmable to N/O or N/C)
- CCTV and access integration
- PC programmed
- Rack mountable (2U)

# Master Stations



**AX-8MV**  
Color Video Master Station, wall or desk mount



**AX-8MV-W**  
WHITE Color Video Master Station, wall or desk mount (Up to max. of 8 door stations and 8 master stations)

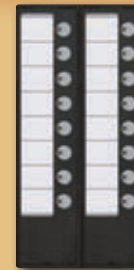

**AX-16SW**  
16-Call Add-on Selector



**AX-8M**  
Audio Only Master Station, wall or desk mount

- 3.5" color TFT LCD monitor (AX-8MV & AX-8MV-W only)
- Hands-free (VOX) or push-to-talk (PTT) communication
- All Call to master stations
- Scan monitoring
- Selective door release
- Privacy and mute functions
- Connection for headset and footswitch

- Channels for additional door stations
- Aesthetically matches AX-8M and AX-8MV (Not recommended for the AX-8MV-W)

# Component Matrix

Number of door stations, sub stations, or adaptors	Number of master stations	Number of add-on selectors per master	Number of central exchange units		Number of add-on exchange units
			AX-084C	AX-248C	
Up to 8	Up to 4	—	1	—	—
Up to 24	Up to 8	1	—	1	—
Up to 40	Up to 4	2	1	—	1
Up to 56	Up to 8	3	—	1	1
Up to 72	Up to 4	4	1	—	2
Up to 88	Up to 8	5	—	1	2
Up to 104	Up to 4	6	1	—	3
Up to 120	Up to 8	7	—	1	3

**NOTES:** Use the AX-248C for systems with more than 4 master stations (May effect the required quantity of AX-320C). Two PS-2420UL power supplies are required per system.

## Door Stations

### Weather & Vandal Resistant Video Door Stations - Surface Mount



**AX-DV**  
Fixed Color Video Door Station, aluminum die cast, surface mount



**AX-DV-P**  
Fixed Color Video Door Station with HID® ProxPoint® Plus Card Reader, aluminum die cast, surface mount



**AX-DV-XP**  
Fixed Color Video Door Station with embedded Stand-Alone Card Reader and host controller, aluminum die cast, surface mount

### Weather & Vandal Resistant Video Door Stations - Flush Mount



**AX-DVF**  
Fixed Color Video Door Station, stainless steel, flush mount



**AX-DVF-P**  
Fixed Color Video Door Station with embedded HID® ProxPoint® Plus Card Reader, stainless steel, flush mount



**AX-DVF-XP**  
Fixed Color Video Door Station with embedded Stand-Alone Card Reader and host controller, stainless steel, flush mount

### Weather Resistant Audio Only Door Stations - Surface Mount



**AX-DM**  
Audio Door Station, plastic cover, mullion surface mount



**IF-DA**  
Audio Door Station, plastic cover, surface mount



**IE-DC**  
Audio Door Station, plastic and aluminum cover, surface mount

### Weather & Vandal Resistant Audio Door Stations - Flush Mount



**IE-SS**  
Door Station, stainless steel, flush mount



**IE-SSR**  
Door Station with a red mushroom call button, stainless steel, flush mount

### Weather Resistant Audio Only Door Station - Flush Mount



**IE-JA**  
Door Station, stainless steel faceplate, flush mount

### Weather & Vandal Resistant CCTV Camera Audio Door Station - Flush Mount



**IE-SSV**  
Door Station with a built-in CCTV camera, stainless steel, flush mount (Requires AXW-AZ)

## Sub Stations



**AX-A**  
Sub Station, plastic cover, surface mount

**AX-AN** (Shown)  
Privacy Sub Station, plastic cover, surface mount

**AX-B**  
Sub Station, plastic cover, semi-flush mount

**AX-BN**  
Privacy Sub Station, plastic cover, semi-flush mount

## Integration Adaptors

### Approved Devices for AXW-AVT & AXW-AVR

Manufacturer	Model	Type
AFI (American Fibertek)	MT/MR -1890	Fiber Optic
Infinova	N3732TA - M / N3732RA - M	Fiber Optic
Meridian Technologies	ST / SR-1W2A2C2G / 2A2C2G-X	Fiber Optic

**NOTE:** The list of approved devices (above) is subject to change. For an updated list, please contact Aiphone Technical Support (Mon.- Fri., 6:00am - 4:30pm) at (800) 692-0200 or e-mail [tech@aiphone.com](mailto:tech@aiphone.com).



**AXW-AZ**  
CCTV Camera Input Module



**AXW-PA1**  
Paging Adaptor



**AXW-AVT**  
Door Station IP or Fiber Optic Transmission Interface Unit



**AXW-AVR**  
Door Station IP or Fiber Optic Reception Interface Unit



# AX Series - Options & Accessories

 <p><b>XP Kit</b> Includes keypad (XRP3), programming cards, and 10 blank entry cards (XC579)</p>	 <p><b>HID-SS</b> Accessory Station with an embedded HID® ProxPoint® Plus Card Reader</p>	 <p><b>ICP-BR</b> Brass Faceplate for IE-JA</p>	 <p><b>ICP-AB</b> Antique Brass Faceplate for IE-JA</p>	 <p><b>SBX-2G</b> Surface Mount Box for HID-SS, IE-JA, IE-SS, IE-SSR, or IE-SSV</p>	 <p><b>SBX-2BH</b> Horizontal Surface Mount Box for HID-SS and IE-JA, IE-SS, IE-SSR, or IE-SSV</p>	 <p><b>SBX-2BV</b> Vertical Surface Mount Box for HID-SS and IE-JA, IE-SS, IE-SSR, or IE-SSV</p>	
 <p><b>SBX-AXDV30</b> 30° Angle Box for AX-DV</p>	 <p><b>SBX-AXDVF</b> Surface Mount Box for AX-DVF</p>	 <p><b>SBX-DVF-P</b> Surface Mount Box for AX-DVF-P and AX-DVF-XP</p>	 <p><b>EL-12S</b> Electric Door Strike, 12V AC/DC, 200mA (Requires PT-1210N)</p>	 <p><b>IER-2</b> Call Extension Speaker</p>	 <p><b>TAR-3</b> External Signaling Relay (Requires SKK-620B)</p>	 <p><b>MCW-S/A</b> Master Station Desk Stand</p>	 <p><b>RY-24L</b> Form C Door Release Relay (1 per door)</p>

## Unit Dimensions

MODEL	HEIGHT	WIDTH	DEPTH	MODEL	HEIGHT	WIDTH	DEPTH	MODEL	HEIGHT	WIDTH	DEPTH
AX-084C	3-7/16"	18-7/8"	13-3/16"	AX-DV-P	9-5/8"	3-15/16"	1"	IE-SSR	4-3/4"	4-3/4"	2"
AX-248C	3-7/16"	18-7/8"	13-3/16"	AX-DVF-P	11-5/8"	5-3/4"	1-7/8"	IE-SSV	4-3/4"	4-3/4"	2"
AX-320C	3-7/16"	18-7/8"	13-3/16"	AX-DV-XP	9-5/8"	3-15/16"	1"	AX-A	7-1/16"	5-5/8"	2-3/16"
AX-8M	6-7/8"	7-5/8"	1-7/8"	AX-DVF-XP	11-5/8"	5-3/4"	1-7/8"	AX-AN	7-1/16"	5-5/8"	2-3/16"
AX-8MV	6-7/8"	7-5/8"	1-7/8"	AX-DM	6-5/16"	1-11/16"	7/8"	AX-B	8-3/16"	6"	1-15/16"
AX-8MV-W	6-7/8"	7-5/8"	1-7/8"	IF-DA	5-1/8"	3-7/8"	1-1/8"	AX-BN	8-3/16"	6"	1-15/16"
AX-16SW	6-7/8"	3-3/8"	1-7/8"	IE-DC	5-5/16"	4"	1-11/16"	AXW-AZ	1-5/8"	7"	4"
AX-DV	7-11/16"	3-15/16"	1"	IE-JA	4-1/2"	4-9/16"	1-3/16"	AXW-AVT	1-5/8"	7"	4"
AX-DVF	9-11/16"	5-3/4"	1-7/8"	IE-SS	4-3/4"	4-3/4"	2"	AXW-AVR	1-5/8"	7"	4"

## Specifications

<b>Power source</b>	24V DC - Use two PS-2420UL
<b>Calling</b>	Tremolo and LED 10~600 secs. (programmable) or infinite
<b>Communication</b>	Push TALK button to reply, communication times out in 30~600 secs. (programmable)
<b>Video Monitor</b>	3-1/2" direct view TFT color LCD
<b>Camera</b>	250,000 pixels
<b>Scanning Line</b>	525 lines
<b>Door Release</b>	Programmable N/O or N/C dry contact, 24V AC/DC, 500mA max. Use RY-24L for larger contact rating
<b>Wiring</b>	Homerun CAT-5e wire to CEU
<b>Distance</b>	Door stations to CEU: 980' CEU to master stations: 980'
<b>Wire type</b>	CEU to master stations: CAT-5e Video Door stations to CEU: CAT-5e IE door stations to CEU: CAT-5e

## System Features

- CAT-5e wiring homerun from each station
- Up to 8 masters and 120 doors/subs/adaptors
- Two talk channels
- Hands-free (VOX) or push-to-talk (PTT) communication
- Selective calling between masters and from masters to door/sub stations
- Masters available with 3-1/2" color TFT LCD monitor
- Composite video output from CEU and video masters
- Normal or priority call levels
- Scan monitoring
- Data output on CEU provides custom integration capability with CCTV and access control systems\*
- PC programmable with a large variety of settings
- All Call or Group Call to master stations
- Compatible with IE and IF Series door stations
- Transfer calls to an outside phone line (requires Viking Model K-1900-5 programmable dialer)
- Optional Features: Headset, footswitch, call transfer to telephone, and PC remote control\*

\*Interface requires custom program (not supplied by Aiphone)

Distributed by:

# 98202  
AX Series Brochure 6/09  
Printed in the USA

GSA Schedule  
GS-35F-0065L

ISO-14001 Certified  
Intertek JGA Environmental System  
Aiphone Co. Ltd.

ISO 9001:2000 Certified  
Intertek ISO 9001:2000  
Aiphone Corp.

Deming Prize  
Aiphone Co. Ltd.

**AIPHONE®**  
Aiphone Corporation  
1700 130th Ave. NE  
Bellevue, WA 98005  
Phone: (800) 692-0200  
Fax: (425) 455-0071  
[www.aiphone.com](http://www.aiphone.com)