

JF Series Hands-Free Video Intercom

Box Sets: select 1 (up to 1 door station and 2 sub master stations can be added)



JFS-2AED
Box Set with JF-DA, JF-2MED, and PS-1820UL

JFS-2AEDV
Box Set with JF-DV, JF-2MED, and PS-1820UL

JFS-2AEDF
Box Set with JF-DVF, JF-2MED, and PS-1820UL

START with a BOX SET

Door Stations: mix and match up to 2
(only 1 if a box set is selected – max. 1 audio door station per system)



JF-DA
Video Door Station
(included with JFS-2AED box set)

- Fixed camera
- Plastic chassis
- Weather resistant
- Surface mount
→ p. 88



JF-DV
Video Door Station
(included with JFS-2AEDV box set)

- Fixed camera
- Zinc die cast cover
- Weather and vandal resistant
- Surface mount
→ p. 88



JF-DVF
Video Door Station
(included with JFS-2AEDF box set)

- Fixed camera
- Stainless steel panel
- Weather and vandal resistant
- Flush mount (back box included)
→ p. 88



JF-DVF-HID
Card Access Video Door Station

- HID® ProxPoint® Plus Proximity Card Reader
- Fixed camera
- Stainless steel panel
- Weather and vandal resistant
- Flush mount (back box included)
→ p. 88



JF-D
Audio Door Station

- Plastic chassis
- Weather resistant
- Surface mount
→ p. 87

Master Station

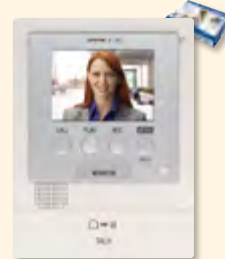

JF-2MED
Video Master Station
(included with all JFS box sets)

- 3-1/2" LCD screen
- Picture Memory
→ p. 87

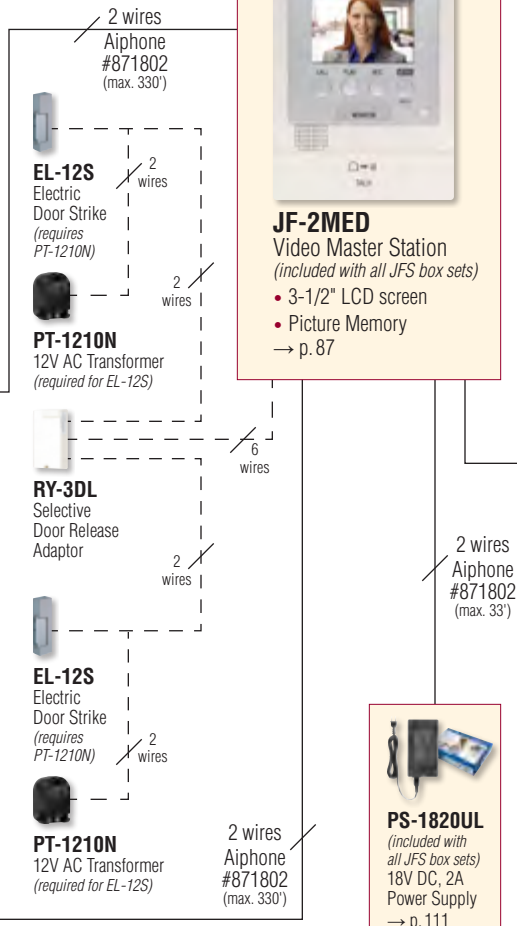

Door Station Features

- Fixed camera provides clear visitor identification (video door stations)
- Card access door station available

Master Station Features

- Compact, attractive design complements most interiors
- Hands-free or push-to-talk communication
- Leave up to 3 voice memos to be heard at the master station (approx. 15 seconds per memo)
- Pre-record up to 2 entrance messages to manually control from the master station, but to be heard at the door station (approx. 10 seconds per message)
- Single or selective door release with RY-3DL
- Video monitoring
- Picture memory records up to 50 calls (JF-2MED only)
- All Call to inside master and sub stations
- Video out to DVR via supplied connector

System Features

- Convenient box sets are complete with a master station, each with a different door station, and a power supply (1 more door station and up to 2 sub master stations can be added for a full 2x3 system)
- Quick and easy to install – only 2 wires!
- Expandable to three inside and two door stations
- All video master station screens turn on when door station calls in

Wiring

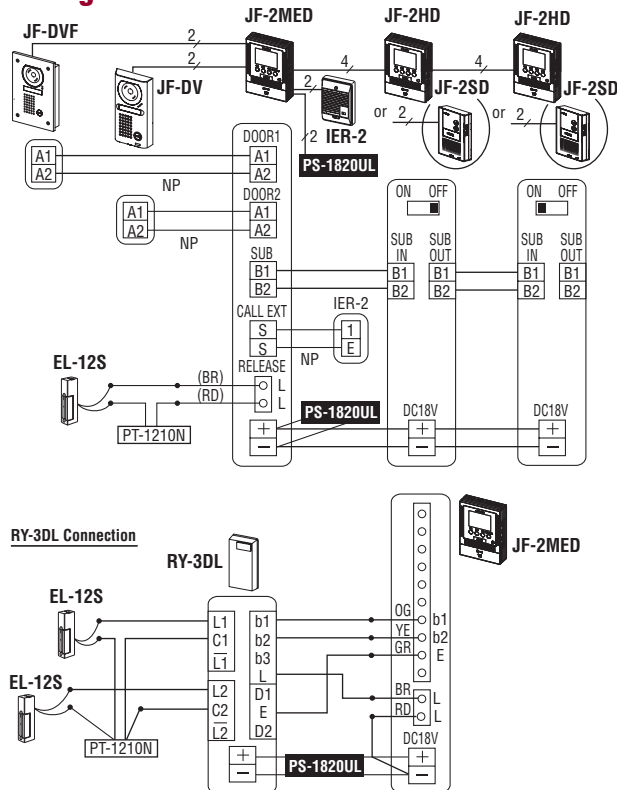

Video Door Stations



JF-DA
Video Door Station
(included with
JFS-2AED box set)

- Fixed camera
- Plastic chassis
- Weather resistant
- Surface mount



JF-DV
Video Door Station
(included with
JFS-2AEDV box set)

- Fixed camera
- Zinc die cast cover
- Weather and vandal resistant
- Surface mount



JF-DVF
Video Door Station
(included with
JFS-2AEDF box set)

- Fixed camera
- Stainless steel panel
- Weather and vandal resistant
- Flush mount
(back box included)



JF-DVF-HID*
Card Access Video
Door Station

- HID® ProxPoint® Plus Proximity Card Reader
- Fixed camera
- Stainless steel panel
- Weather and vandal resistant
- Flush mount
(back box included)



Surface mount box
available for flush
mount stations!
See p. 106

* HID® stations require a
3rd party host. Power for
card reader and door strike
require additional wire.

Features

- Fixed camera provides clear video
- LED illumination automatically turns on in low light conditions

Features

(additional for JF-DA)

- Locator LED above call button
- Mounts directly to wall or 1-gang box

Features (additional for
JF-DV, JF-DVF, JF-DVF-HID)

- LED backlit nameplate

Specifications

Power Source	Supplied by Master Station
Communication	Hands-free
Camera	Type: 1/4" CCD Area View: 2' 1" vert. x 3' 1" horiz. at 20°
Temp. Rating	14°~140°F (-10°~60°C)
Material	JF-DA: fire resistant PC + ABS plastic JF-DV: zinc die cast JF-DVF, JF-DVF-HID: stainless steel
Mounting	JF-DA: surface mount directly to wall or 1-gang box JF-DV: surface mount directly to wall JF-DVF: flush mount with included back box or surface mount with SBX-DVF JF-DVF-HID: flush mount with included back box or surface mount with SBX-DVF-P
Wire Type	Door Station to Master Station: 2-cond., low cap, non-shielded – use Aiphone #871802
Distance	Door Station to Master Station: 165' (22AWG) 330' (18AWG)

JF-DA

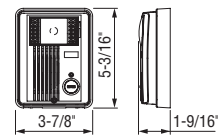

JF-DV

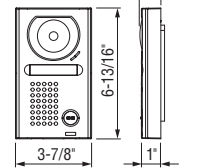

JF-DVF

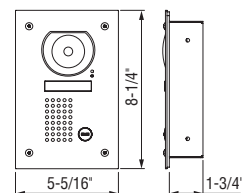

JF-DVF-HID

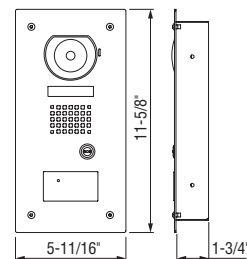

Long Distance Adaptor



JBW-BA
Long Distance
Adaptor for Video
Door Stations

Features

- Extends wiring distance from door stations to master stations up to 820' max.
- Requires low capacitance Aiphone wire #851602 or #851602DB

Specifications

Power Source	18V DC – use PS-1820UL
Capacity	One adaptor unit for each video door station located beyond the standard specified wire distance
Mounting	DIN rail (included)
Wire Type	2-cond., low cap, PE, solid, non-shielded – use Aiphone #851602 or #851602DB (direct burial)
Distance	Adaptor to Door Station: 820' Adaptor to Master Station: 165'

JBW-BA

