

AIPHONE

JO-1MDW

Master monitor station

OPERATION MANUAL

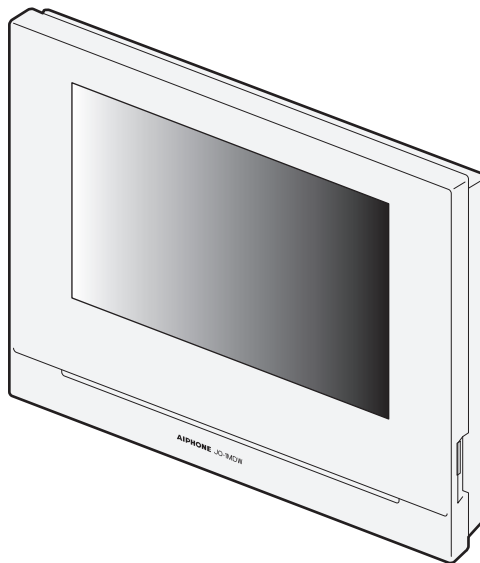

Read this "Operation Manual" prior to usage to ensure safe and correct operation. Keep this in a safe place for future reference.

The illustrations used in this manual may differ from the actual ones.

PRECAUTIONS



Prohibited



Do not dismantle unit











Keep unit away from water



Be sure to follow the instruction





WARNING

(Negligence could result in death or serious injury.)

-  1. Do not disassemble or modify the station. Fire or electric shock could result.
-  2. Do not put any metal and flammable material into the station through the openings. Fire or electric shock could result.
-  3. Keep the station away from water or any other liquid. Fire or electric shock could result.
-  4. If there is smoke, unusual odors, or abnormal sounds, or if the station is dropped or damaged, unplug and remove power immediately. These may result in fire or electric shock.
-  5. For power supply, use Aiphone power supply model specified for use with system.
If non-specified product is used, fire or malfunction could result.
-  6. Do not, under any circumstances, open up the station.
Voltage within some internal components may cause electrical shock.
-  7. Do not disconnect the station. Electric shock could result.
-  8. Do not use the station in the following locations or under the following conditions. Ignoring these may result in malfunction.
 - This product is not intended for commercial applications, such as factories or hospitals.
 - Near an electric medical equipment and locations such as Operating Rooms, ICU, or CCU.
 - Near automatic control equipment such as auto doors or fire alarm panels.
 - In an area within 15cm of a cardiac pacemaker.

CAUTION

(Negligence could result in injury to people or damage to property.)

-  1. Do not put anything on the station or cover the station with cloth, etc. Fire or station trouble could result.
-  2. Do not apply excess pressure to the LCD screen. If the screen is punctured it may result in injury.
-  3. If the LCD is punctured, do not allow skin contact with the liquid crystal inside. Inflammation could result.
 - * If liquid crystal is ingested, immediately gargle with water and seek medical attention.
 - * If contact with the eyes or skin occurs, clean with pure water and seek medical attention.
-  4. Do not puncture the LCD screen with a sharp object. If the screen is punctured it may result in injury.
-  5. Maintain a reasonable distance from the speaker. Placing your ear on the speaker may cause harm.

General Precautions

1. Read this manual prior to usage to ensure safe and correct operation. Keep this in a safe place for future reference.
2. Keep the station more than 20 cm (7-7/8") away from wireless devices such as wireless routers, or cordless telephones. It may cause the image or sound distortion.
3. Keep the station more than 1 m (3.3') away from radio or TV set. It may cause interference and unwanted noise.
4. Move to within 30cm (12") or less of the station for communication. Standing too far away may make it difficult for the other party to hear the communication.
5. Keep the intercom wires more than 30cm (12") away from AC 100-240V wiring. AC induced noise and/or unit malfunction could result.
6. When installing or using the station, consider to the privacy as the responsibility of customer.

7. In order to prevent sensitive information stored in the station from being lost or stolen, it is the customer's responsibility to delete settings, recorded video/audio, and other information stored in the station, when discarding, transferring, or returning the station. Refer to page 24, 25 and 35 of this manual for how to erase the information.
8. As to other 3rd party devices (such as sensor, detectors, door releases) used with this system, comply with the Specifications and Warranty conditions that the manufacturers or vendors present.
9. Avoid using the station in places under direct sunlight. If it is unavoidable, block out light during use.

Notice

- The illustrations and images used in this manual may differ from the actual ones.
- Aiphone will under no conditions be liable for any damages or losses resulting from this product's contents or specifications.
- Aiphone will under no conditions be liable for damage occurring due to the inability to communicate due to malfunctions, problems, or operational errors in this product.
- The station is inoperative during power failure.
- If the station is used in areas where there are business-use wireless devices such as a transceiver or mobile phones, it may cause malfunction.
- It must be noted in advance that the LCD panel, though manufactured with very high precision techniques, inevitably will have a very small portion of its picture elements always lit or not lit at all. This is not considered a station malfunction.
- Hands-free calls are a method of automatically switching between the transmitter and receiver so that the louder of the two is prioritized, making it audible by the quieter of the two. If the surrounding area is loud, the call may be interrupted, making it difficult to respond.
- During communication, the voice may not come through clearly when speaking before the other party has finished talking. Communication will proceed smoothly when waiting until the other party has finished before speaking.
- When wall-mounted, the top of the station may darken. This does not indicate a malfunction.
- If warm-color lighting is shining on the camera, the tint of the image displayed on the screen may be affected.
- Warm-color lighting shining on the video door station may change the tint of the image on the screen.
- If glare from an LED light or fluorescent light, etc. enters the camera, black stripes may appear on the liquid crystal display of the master station, the screen may flicker, and colors may differ. This is not a malfunction.
- When outside temperature lowers sharply after rainfall, etc., the inside of the camera may fog up slightly, causing a blurry images, but this is not a malfunction. Normal operation will be restored when moisture evaporates.
- Aiphone assumes no responsibility for corruption of saved information (such as changes to or deletion of saved information).
- If the surface of a video door station freezes during wintertime, the image may become difficult to see or the call button (including the call button of video door station) may not move, but this is not a malfunction.
- If the power is turned off for at least 15 minutes in an event such as a power outage, the date and time will revert back to the default setting.

Table of Contents

PRECAUTIONS	2
--------------------------	---

PREPARATION

System configuration	4
Part names and functions	5
Operation panel	5
How to read screen	6
Initial set-up	7
Setting the current date and time	7
Changing the display language	7
Preparing a microSDHC card	8
About microSDHC card	8
Inserting/removing a microSDHC card	8
Formatting a microSDHC card	9
Connecting with a mobile device	10
Flow of the settings	10
Connecting the station with Wi-Fi	11
Connecting using "Auto Connect (WPS)"	11
Connecting using "Manual Setup"	11
Connection check	12
Confirming the current network settings	12
Enabling or disabling the network connection	13
Selecting the antenna	13
Connecting a mobile device with a Wi-Fi router	15
Registering a mobile device to the station	15
Downloading the App to the mobile device	15
Registering a mobile device to the station	15
Deleting the mobile device from the station	17

USING THE STATION

Receiving a call	18
Answering a call	18
Operation during receiving a call or communication	19
Adjusting the screen brightness	19
Adjusting the receiving volume	19
Changing the display to the full-screen mode	19
Communication using touch-to-talk	20
Recording	20
Monitoring the door station	21
Playing recordings	22
Screens and icons	22
Playing recordings	23
Protecting recordings	23
To protect a recording on the recording list	23
To protect the currently-selected recording while in standby	23
Deleting a recording	24
To delete a recording	24
To delete all recordings	25
Copying recordings from the built-in memory onto a microSDHC card	25
Notification	26

SETTINGS

Settings list	27
Adjusting screen brightness	28
Changing the sound settings	29
Adjusting receiving volume	29
Adjusting ringtone volume	29
Enabling/Disabling the touch sound	29
Changing the time settings	30
Setting the current date and time	30
Selecting the display format of the date and time	30
Setting the time zone	30
Setting daylight saving time	31
Changing the display language	31
Setting the talk duration time	31
Cleaning mode	31
Setting of door release/option	32
Setting of notification LED	32
Other settings	33
Registering/Deleting a mobile device	33
Setting a microSDHC card	33
Viewing station information	34
Viewing a notification for updating the station	34
Configuring the settings for automatically updating the station	34
Configuring network settings	35
Initializing user settings	35
Confirming the related regulations	35
Confirming information about Protection of Personal Information	35
Administrator settings	36
Exporting the log file to the microSDHC card	36
Setting Door Release duration	36
Setting Option Output duration	37
Restoring all settings to the factory default	37

FOR PROPER USE OF THE STATION

Updating a firmware of the station	38
Automatic update through the network	38
Receiving a notification for available updates through the network	38
Updating the station by using a microSDHC card on which the newest version of the firmware is stored	39
Cleaning	39
Cleaning the exterior surfaces	39
Cleaning the screen	39
Troubleshooting	40
Technical precautions	40
Specifications	41
Regulations	41
Warranty	42

PREPARATION

System configuration

The figure below is a system configuration example.

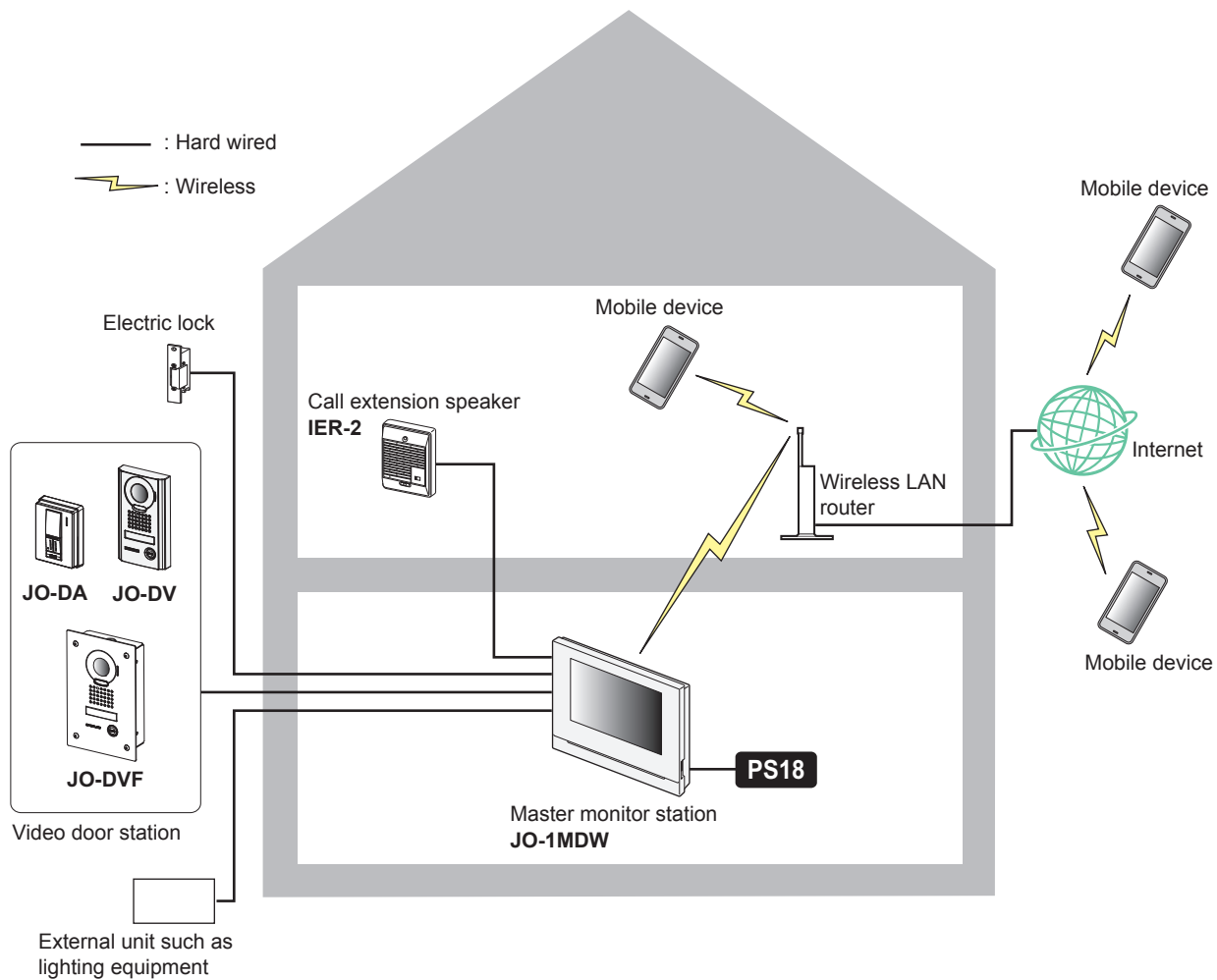

Maximum number of each device available in a system

Device	Max. number
Video door station	1
Master monitor station	1
Mobile device	8
Expansion monitor station	1

* When you will connect an expansion monitor station (JO-1FD), refer to "JO-1FD INSTALLATION & OPERATION MANUAL".

* Refer to "JO Series INTERCOM APP Type B OPERATION MANUAL" for how to use the INTERCOM APP Type B.

Part names and functions

Operation panel

Remove protective film before use.

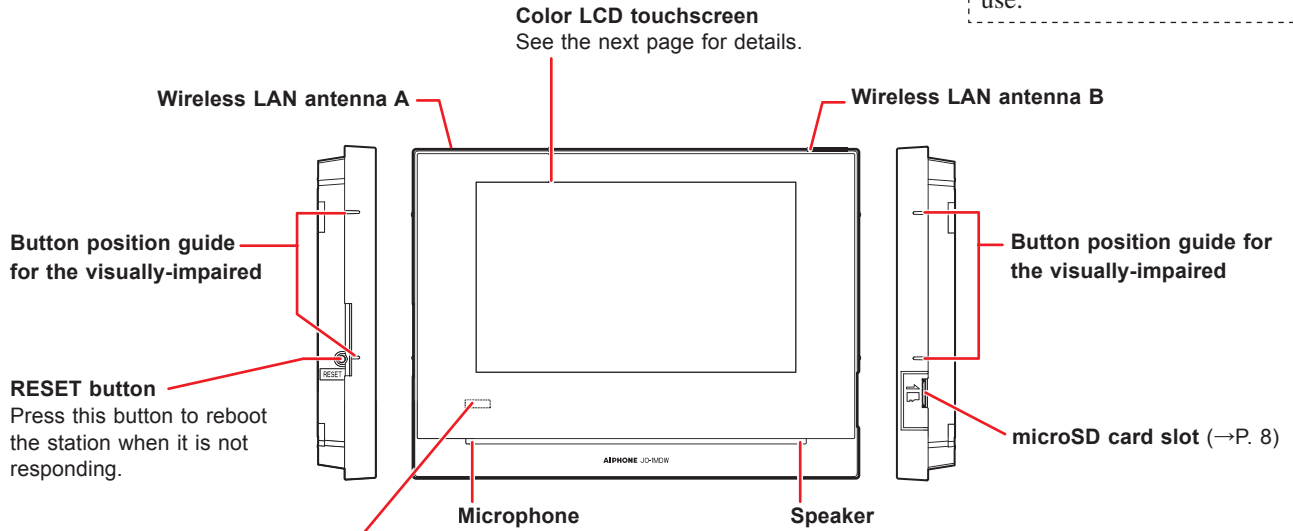

Notification LED
Indicates the current status of the station by lighting up or flashing.

Station status	Indication pattern
Current date and time have not been set.	Solid light
Rebooting.	Solid light
Updating the firmware.	Solid light
Some recordings have not been viewed.	
Some notifications have not been viewed.	
A short-circuit is detected.	

How to read screen

The screen of the station is a touchscreen. Simply tap the icons or buttons displayed on the screen. The following are examples of typical screens and icons.

* The displayed screens and icons may differ depending on the devices connected to this system.

■ MENU screen

This screen appears when the monitor is turned on.

Recording List (→P. 22)
Tap this to play recordings.
* This icon blinks when there is a recording that has not been played yet.

Notification (→P. 26)
Tap this to display the notification list.
* This icon blinks when a new notification has arrived.

Set whether or not to enable mobile device to receive calls from the door station.
Off
Tap this to turn the monitor off.

Settings (→P. 27)
Tap this to configure the settings.

Door release (→P. 18)
Tap this to unlock the door at the door station.
* Depending on settings, this icon may not be shown.

Option (→P. 18)
Tap this to activate the connected external device.
* Depending on settings, this icon may not be shown.

Displayed when the ringtone is set to mute.

Indicates the Wi-Fi signal strength when the station is connected to the network. (→P. 10)

Displayed when a microSDHC card is installed and available.

Monitor (→P. 21)
Tap this to monitor the outside of the door.

Current date and time
By tapping this, you can set the current date and time. (→P. 30)

Tap this to communicate with the door station.

■ While communicating with a video door station

Door release (→P. 18)
Tap this to unlock the door at the door station.

Tap this to switch full-screen.

Option (→P. 18)
Tap this to activate a connected external device.

Tap this to answer a call.

Tap this to record the currently displayed video.
* ○ will be lit in red while recording.

Tap this to configure screen brightness and receiving volume. (→P. 19)

■ Navigation buttons

Tap to return to previous screen or undo the last action.

Tap to return to the previous page.

Tap to move to the next page.

Tap to apply or confirm.

* (Deleting all recordings) will be shown when the recording list is displayed.

NOTE:

Do not puncture the LCD screen with a sharp object. If the screen is punctured it may result in injury.

Initial set-up

Setting the current date and time

When the station is powered up for the first time, set the current date and time.

- 1 If the monitor is off, tap the screen to turn on the MENU screen.

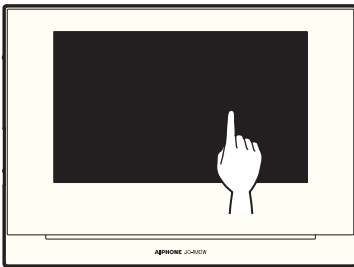

- 2 Tap **Set date and time**.

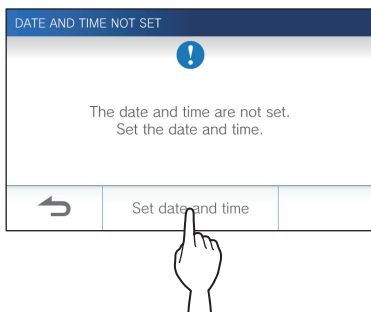

- 3 Tap the proper time zone from the list of time zones.

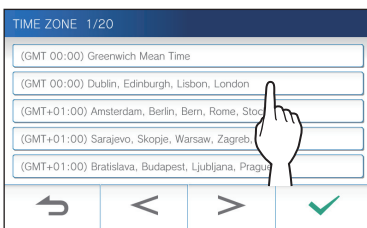

* Tap **>** or **<** to change the pages of the list.

- 4 Tap **✓** to apply changes.

The CURRENT TIME screen is shown.

- 5 Set the month, day, year, hour, and minute individually by tapping **▼** or **▲**.

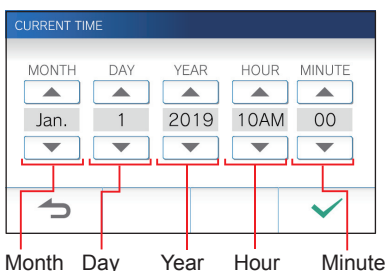

- 6 When the setting has finished, tap **✓**.

To correct date and time

Correct the current date and time any time by following the procedure below.

- 1 From the MENU screen, tap → **Date/Time** → **Current Time**.
- 2 Set the month, day, year, hour, and minute individually by tapping **▼** or **▲**.
- 3 When the setting has finished, tap **✓**.

NOTE:

- A maximum of 60 seconds time gain/loss can occur in the displayed time over a month. It is recommended to correct the time periodically.
- When the station is connected to the internet, the date and time are automatically corrected.
- If there is no power supply for 15 minutes or more, the date and time return to default.

Changing the display language

The display language for the screen is set to English by default. First, select a language as follows.

- 1 From the MENU screen, tap → **Language**.
The LANGUAGE screen is shown.
- 2 Tap desired language, then tap **✓**.



Preparing a microSDHC card

About microSDHC card

A microSDHC card is not included with the station. Choose a microSDHC card using the recommended specifications below.

Specifications

Standard	microSDHC
Storage Capacity	4 to 32 GB
Format	FAT32
Speed Class	10

The recordings are stored in a microSDHC card. If a microSDHC card is not installed, recordings are saved in the built-in memory. Up to 10 recordings can be saved in the built-in memory.

- * The maximum number of recordings that can be saved in the microSDHC card depends on its storage capacity.
- * Up to 1,000 recordings can be saved.

NOTE:

- Use a card complying with the SD standard. Some cards may not perform correctly.
- If a microSDXC card is inserted in the station and formatted with the station, it will not be identified as a microSDXC card.
- Be sure to format a microSDHC card when using it in the station for the first time. If there remain some data other than recordings in the card, a recording may fail because of a shortage of memory.
- Do not remove a microSDHC card or reboot the station while recording, formatting a card or copying recordings onto a card, otherwise the card may fail to perform properly when recording or playing videos. Should this occur, reformat the card.
- Aiphone is not responsible for the performance of a microSDHC card.

Inserting/removing a microSDHC card

NOTE:

Be sure to insert or remove a microSDHC card when the station is in standby mode, and not communicating with video door station.

■ Inserting a microSDHC card

In standby mode, insert a microSDHC card into the card slot.

Insert the card in the way shown below.

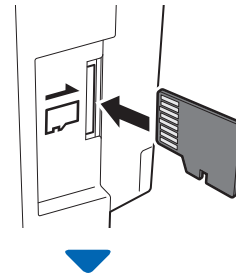

- If compatible, a message will appear saying the card has been recognized.
- A message may appear to format the card. If so, see page 9.

■ Removing a microSDHC card



Lightly push on the card to pop out.

Formatting a microSDHC card

MicroSDHC card may require to be formatted when used with the station for the first time.

* Previously formatted microSDHC card may not work with the station. Be sure to format a microSDHC card using the station.

* Note that formatting a microSDHC card deletes all existing data.

- 1** From the MENU screen, tap  → 
→ **Other Settings**.

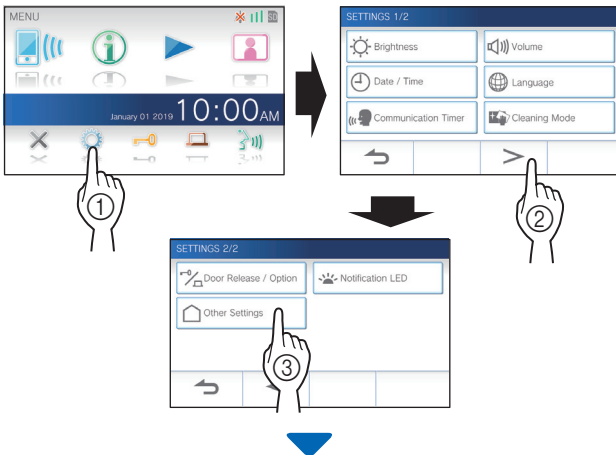

A message will appear asking whether or not to proceed.

- 2** To continue formatting a microSDHC card, tap .

- 3** Tap **microSDHC card** → **Format microSD Card**.

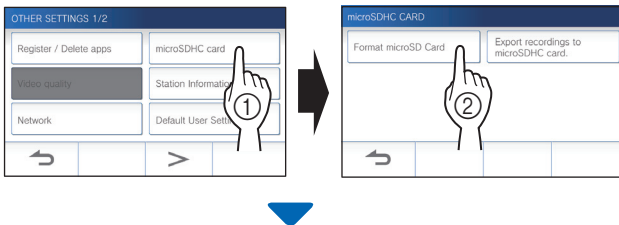

A message will appear asking whether to continue formatting a microSDHC card or not.

- 4** Tap .

When completed, "The microSDHC Card has been formatted." will be shown.

* This process may take an extended amount of time.

Connecting with a mobile device

Flow of the settings

The following settings are needed to establish a connection link with a mobile device.

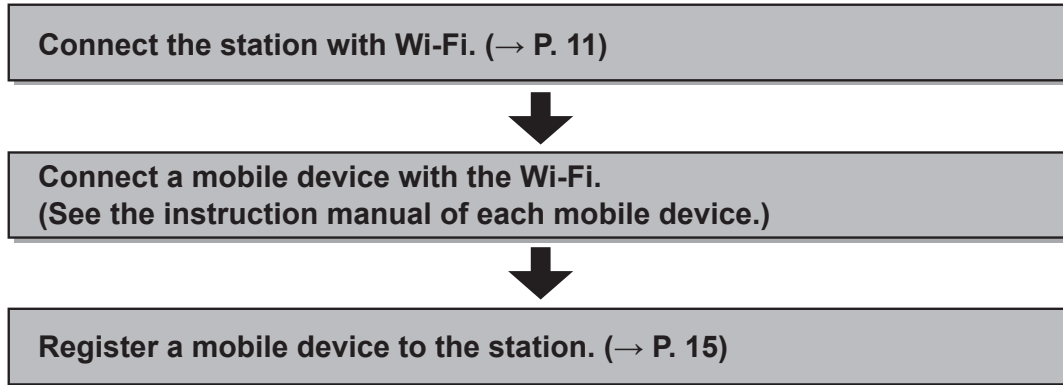

NOTE:

- Prepare a commercially available Wi-Fi router for connecting the system to the internet. A Wi-Fi router is not included with this product.
- Using a microwave oven may affect Wi-Fi communication in 2.4 GHz band.
- The bandwidth required for connecting to Internet is as follows (when only the station is connected to Wi-Fi):
 - Minimum Internet connection bandwidth in upload: 1.3 Mbps
 - Minimum Internet connection bandwidth in download: 0.2 Mbps
- Be sure to set the current date and time on the station in advance. If the set time differs from the current time for more than 1 month, the Aiphone app may not work correctly.
- Up to 8 mobile devices can be registered to the station.

Features:

- A call and video from the door station can be received with a mobile device. Communication between the door station and a mobile device is also possible.
- Recordings on the station can be played and viewed with a mobile device.

Checking the signal strength:

The connection status between the station and the network can be checked on the MENU screen. When the connection settings have been completed, confirm whether the connection is successful.

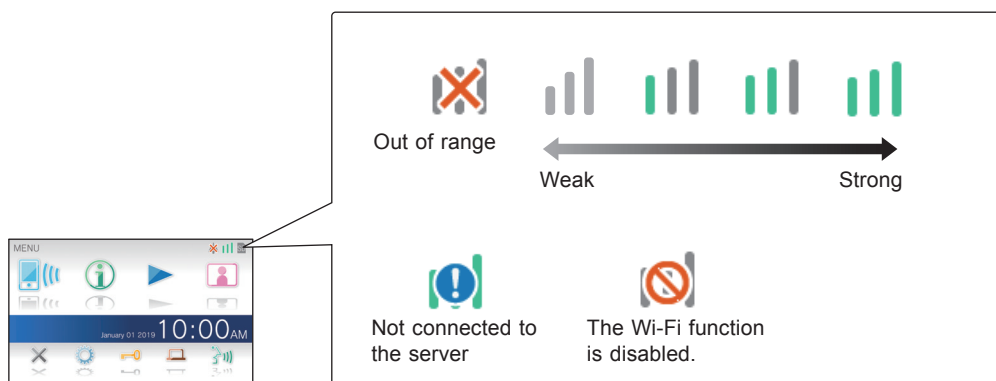

Connecting the station with Wi-Fi

There are two connecting methods available.

- Auto Connect (WPS)
- Manual Setup

Connecting using "Auto Connect (WPS)"

This method connects to a Wi-Fi network using the "Wi-Fi Protected Setup™" function of a router/STB. Select this method when it is not required detailed settings.

- From the MENU screen, tap → → **Other Settings**.

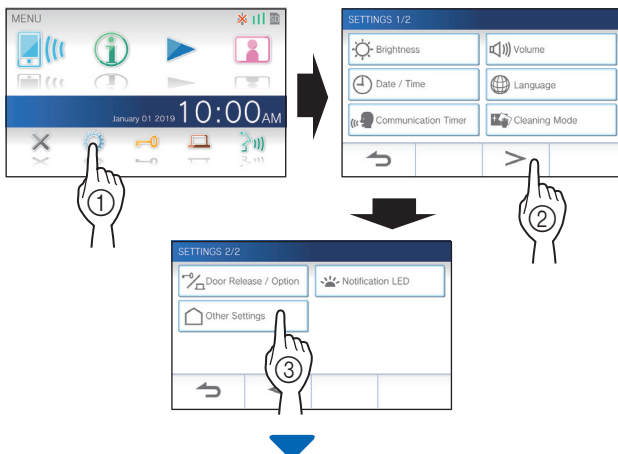

A message will appear asking whether or not to proceed.

- To continue configuring the settings, tap .
- Tap **Network** → **Auto Connect (WPS)**.

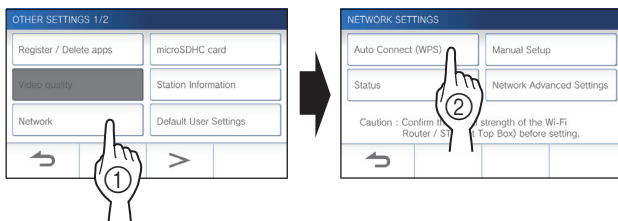

- Press the WPS button on the Wi-Fi router, and then tap .

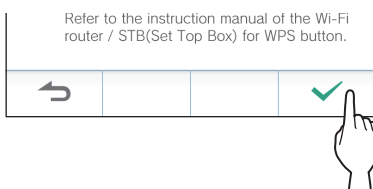

Connection between the master monitor station and wireless router is established automatically. (In some cases, it may be necessary to tap before pressing the WPS button on the wireless router.)

When "The Wi-Fi router has been connected." is shown, the connection is successful.

■ If the connection is failed

"Connection failed" will be shown.

Confirm the current network settings and change the settings properly. (→ P. 12)

If the connection cannot be established properly, use the "Manual Setup" method.

* If you connect the station to the Wi-Fi router by using the "Auto Connect (WPS)" method after the IP address was set by using "Manual Setup" method, initialization of the user setting is necessary. (→ P. 35)

Connecting using "Manual Setup"

Select this method to configure the detailed settings.

- From the MENU screen, tap → → **Other Settings**.



A message will appear asking whether or not to proceed.

- To continue configuring the settings, tap .
- Tap **Network** → **Manual Setup**.

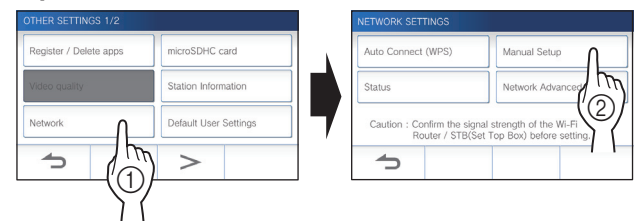

- Tap **Wi-Fi**.

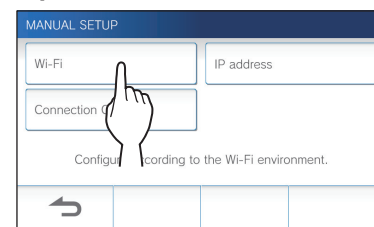

The setting items will be shown.

- Configure the settings for each item.

Item	Description
SSID	Tapping the entry field displays the keyboard. (→ P. 14) Use the keyboard to enter the SSID of the wireless LAN router.
Encryption method	Tapping the entry field displays the choices. Select the appropriate encryption method, and tap <input checked="" type="checkbox"/> . Settings: None / WEP / WPA-PSK(TKIP/AES) / WPA2-PSK(AES) Default: WPA2-PSK(AES)
Password	Tapping the entry field displays the keyboard. (→ P. 14) Use the keyboard to enter the password.

* When using the keyboard, be sure to tap after filling out the entry field to determine the contents.

* Do not use the character " and ¥ for setting the SSID.

PREPARATION

- 6** When the Wi-Fi settings have been completed, tap .

If it returns to the MANUAL SETUP screen, tap .

- 7** Tap **IP address**.

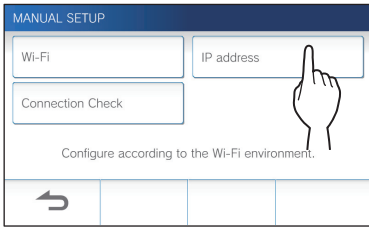

The setting items will be shown.

- 8** Configure the settings for each item.

Item	Description
IP	Select the setting method (Auto or Manual). * When "Auto" is selected, the settings are automatically configured and grayed out.
IP Address/ Subnet Mask/ Default Gateway/ DNS Server	It can be configured only when IP is set to "Manual". Tapping the entry field displays the keyboard. (→ P. 14) Tap  after filling out the entry field to determine the values.

* Tap  or  to change the page of the item list.



- 9** When the IP settings have been completed, tap .

If it returns to the MANUAL SETUP screen, tap .

NOTE:

If you connect the station to the Wi-Fi router by using the "Auto Connect (WPS)" method after the IP address was set by using "Manual Setup" method, initialization of the user setting is necessary. (→ P. 35)

Connection check

- 1** From the MENU screen, tap  →  → **Other Settings**.

A message will appear asking whether or not to proceed.

- 2** To continue configuring the settings, tap .

- 3** Tap **Network** → **Manual Setup**.

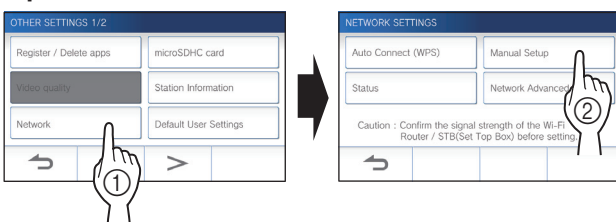

- 4** Tap **Connection Check**.

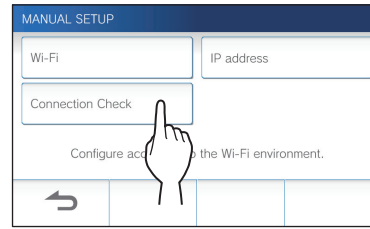

- 5** Tap .

The master monitor station will check the wireless network connection.



When "The Wi-Fi router has been connected." is shown, the connection is successful.

■ If the connection is failed

Confirm the current network settings and adjust if needed. (→ P. 12)

Confirming the current network settings

Confirm the current network settings when the network connection is unstable.

- 1** From the MENU screen, tap  →  → **Other Settings**.

A message will appear asking whether or not to proceed.

- 2** To continue configuring the settings, tap .

- 3** Tap **Network** → **Status**.

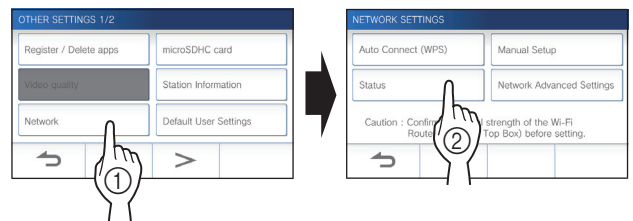

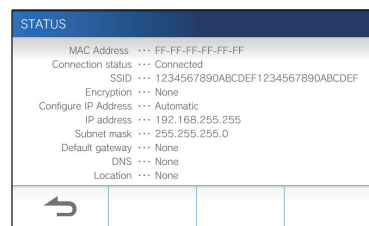

The current settings will be shown.



* If required, change the settings (→ P. 11).

Enabling or disabling the network connection

If necessary, disable or enable the network connection.

- 1 From the MENU screen, tap  →  → **Other Settings**.

A message will appear asking whether or not to proceed.

- 2 To continue configuring the settings, tap .
- 3 Tap **Network** → **Network Advanced Settings** → **Wi-Fi**.

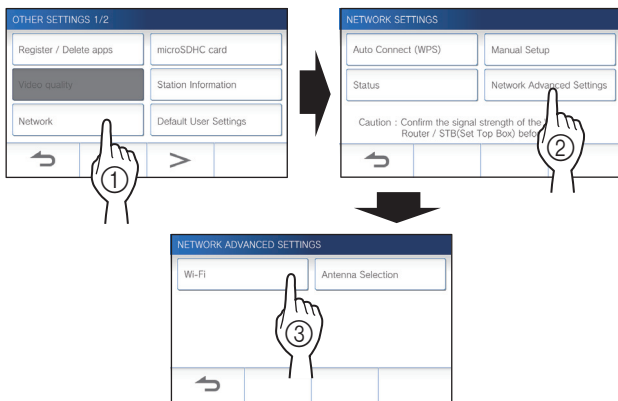

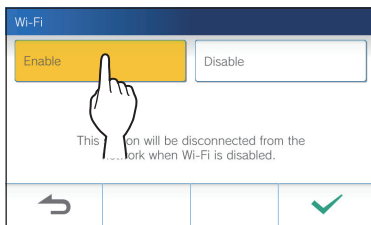

- 4 Tap either **Enable** or **Disable**, and tap .



Selecting the antenna

Antenna of the station can be selected according to the reception status or the location of the station or Wi-Fi router.

- 1 From the MENU screen, tap  →  → **Other Settings**.

A message will appear asking whether or not to proceed.

- 2 To continue configuring the settings, tap .
- 3 Tap **Network** → **Network Advanced settings** → **Antenna selection**.

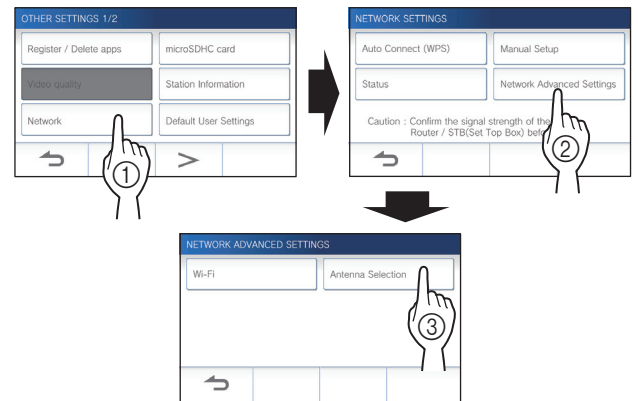

- 4 Tap either **Antenna A** or **Antenna B**, and tap .

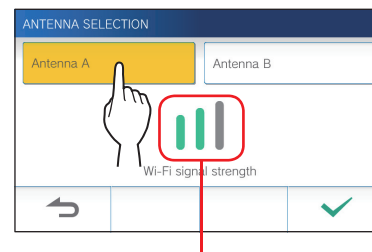

* The Wi-Fi signal strength of the selected antenna will be shown.

Using the keyboard

Full keyboard

Alphanumeric input mode (lower case)

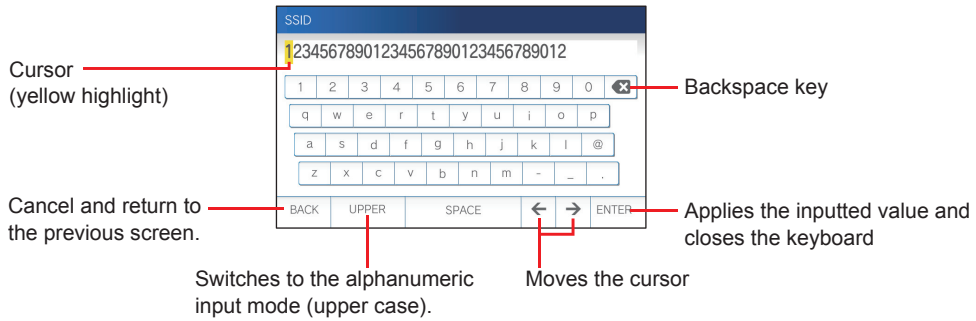

Symbol input mode



Switches to the alphanumeric input mode (lower case).

Alphanumeric input mode (upper case)



Switches to the symbol input mode.

For number input

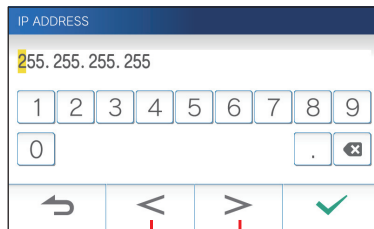

Moves the cursor

For hexadecimal number input

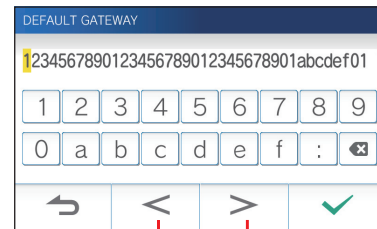

Moves the cursor

* The use of each key is the same with the full keyboard.

Connecting a mobile device with a Wi-Fi router

Registering a mobile device to the station, the mobile device must be connected to the same Wi-Fi router as the one connected to the station. Refer to the instruction manual of the mobile device for how to connect the mobile device to a Wi-Fi router.



Registering a mobile device to the station

NOTE:

- Ensure the mobile device is connected to the Wi-Fi network.
- The screen images in this manual may differ from the actual product.
- A confirmation screen may be shown during registering or after registration. Read the contents carefully and tap "Agree". Cannot receive notices for the intercom app without confirmation.
- When registering the first mobile device, the location setting is required.

Downloading the App to the mobile device

Operation with the station

- 1 From the MENU screen, tap  →  → **Other Settings**.

A message will appear asking whether or not to proceed.

- 2 To continue configuring the settings, tap .
- 3 Tap **Register / Delete Apps** → **App Info**.

Aiphone intercom app information is shown on the screen.

Operation with a mobile device

- 4 Search "Intercom App Type B" and download the Aiphone INTERCOM APP Type B.

Download from the following:

- iOS device: App Store
- Android device: Google Play

* App Store is trademark of Apple Inc. in the United States and/ or other countries.
 * Google Play is trademark of Google Inc. in the United States and/ or other countries.

Registering a mobile device to the station

Operation with a mobile device

- 1 Run the INTERCOM APP Type B from the icon on the Home screen.



- 2 Allow this app to send notifications.
- 3 Set the display language.

Select the language by tapping the screen.



- 4 Read the license agreement carefully and tap **Agree**.

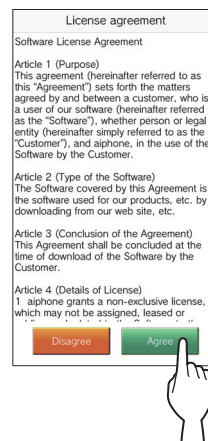

* Cannot use the intercom app without agreement.

5 Read the screen for the End User Licence Agreement carefully and tap **Next.**

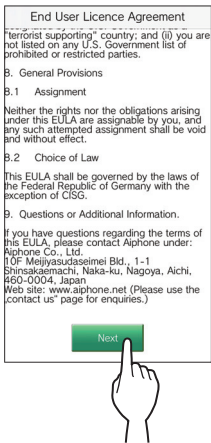

Operation with the station

6 From the MENU screen, tap → → **Other Settings.**

A message will appear asking whether or not to proceed.

7 To continue configuring the settings, tap .

8 Tap **Register / Delete Apps → **Register Apps**.**

9 Tap the location, and tap .

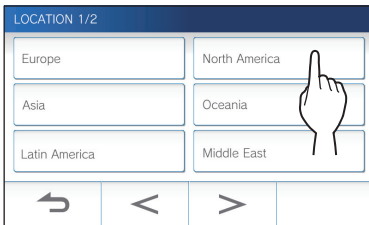

* Another area will be shown on the next page. tap or to change the page.

* When registering the second and subsequent mobile devices, the location setting is unnecessary.

10 Select **Agree or **Disagree** and tap .**

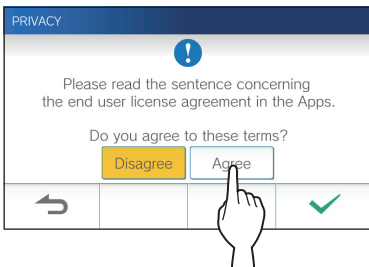

Operation with a mobile device

11 Tap **Start at the bottom of the instruction.**

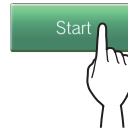

Confirmation with the station

12 One-time password will be shown.

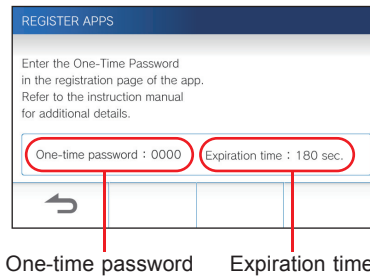

* If the steps 1 to 11 have not been completed with the mobile device, the below screen will be shown. Confirm and follow steps 1 to 11 again.

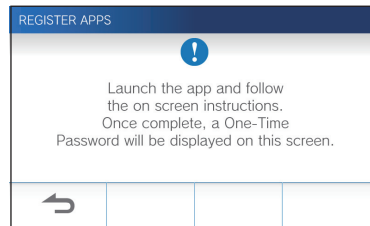

Operation with a mobile device

13 Enter the one-time password displayed on the screen of the station within the expiration time, and tap **Next.**

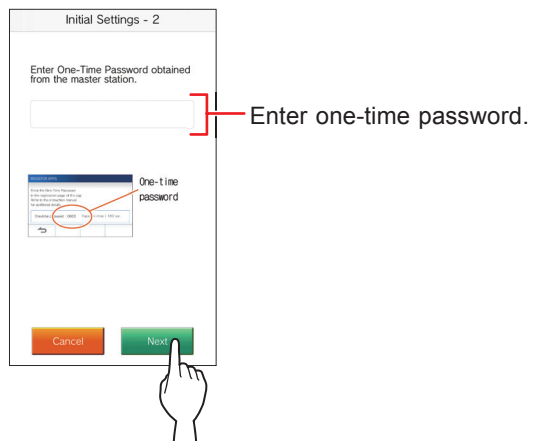

14 Enter the user name of the mobile device and tap **Registration.**

Name is limited to 12 characters.

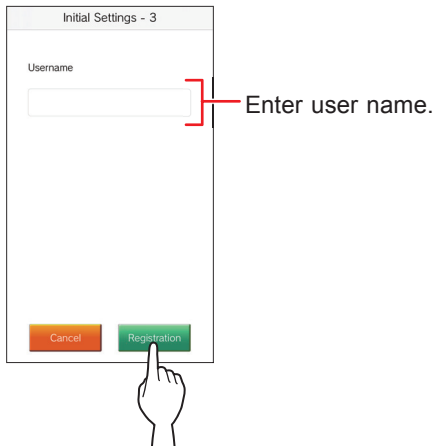

15 Follow the on-screen instructions.

"Initial Settings has been set." is shown with registration is successful.

16 Try to receive a call from the door station.

- If you will perform an operation confirmation after the registration has been completed, first return to the MENU screen.
- For more information on using the app and detailed settings, refer to the instructions provided with the app.
- To register another mobile device, repeat the process starting at step 1.

Deleting the mobile device from the station.

1 From the MENU screen, tap → **> → **Other Settings**.**

A message will appear asking whether or not to proceed.

2 To continue configuring the settings, tap .

3 Tap **Register / Delete Apps → **Delete Apps**.**

4 Tap the mobile device to delete.



* The 7th and 8th mobile devices will be shown on the next page. Tap or to change the page.

The confirmation message will be shown.

5 To delete App, tap .

When "App has been deleted." is shown, the deletion has succeeded.

USING THE STATION

Receiving a call

When receiving a call from a door station

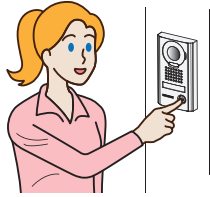

- The ringtone sounds.
- The video at the door station is displayed.
- Automatic recording begins.

Answering a call

■ To answer the call

1 Tap .

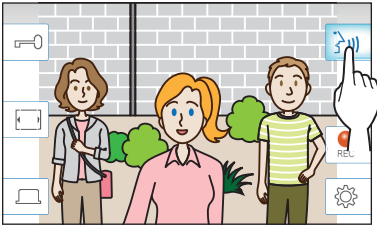

2 Speak to the visitor.

- * Speaking simultaneously may cause intermittent audio.
- * Talk duration is 60 seconds by default. It can be adjusted up to 180 seconds. (→ P. 31)
- * The screen turns off after approx. 45 seconds if there is no operation.

■ To release the door

While being called or communicating, tap .

- * Available only when an electric door lock is installed at the door and connected to the station.
- * Please refer to the installation manual for details how to connect an electric lock to the master monitor station.

■ To activate an external unit such as lightning equipment

While being called or communicating, tap .

- * Available only when an external device, such as a light, is connected to the station.
- * Please refer to the installation manual for details how to connect an external unit such as lightning equipment to the master monitor station.

■ To end the communication

Tap .

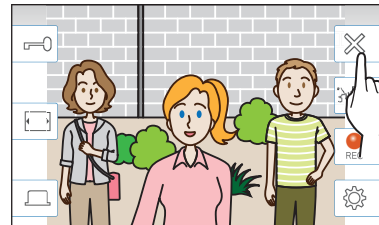

Other features

- Screen brightness and receiving volume can be adjusted during a call. (→ P. 19)
- When the ambient noise is loud enough to interrupt the audio, the touch-to-talk method is recommended. (→ P. 20)
- An automatic recording begins when receiving a call. Manual recording is also available. (→ P. 20)
 - * When communication ends, recording does as well.
- If the call button of the door station is pressed when the surroundings of the door station is dark, the LED on the door station illuminates.

NOTE:

Keep a distance of more than 20 cm (7-7/8") from person's body while speaking.

Operation during receiving a call or communication

Adjusting the screen brightness

1 Tap .

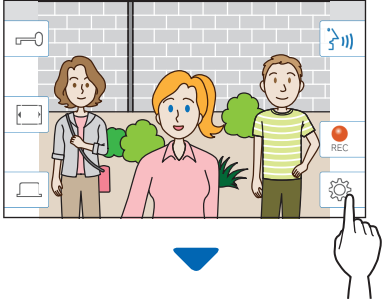

The brightness adjusting bar will be shown.

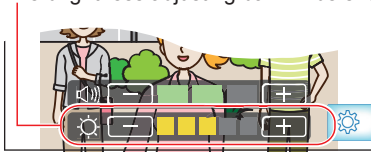

2 Tap  to adjust the screen brighter, and  to adjust the screen darker.

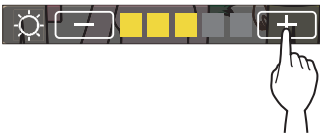

The default value is 3, with a minimum of 1 and a maximum of 5.

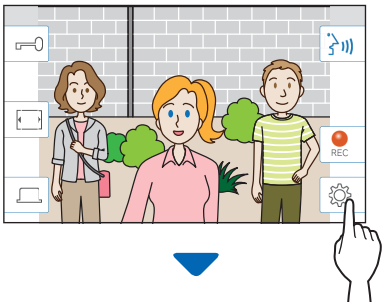

Adjusting the receiving volume

1 Tap .



The volume adjusting bar will be shown.



2 Tap  to adjust the volume higher, and  to adjust the volume lower.



The default value is 2, with a minimum of 1 and a maximum of 3.

Changing the display to the full-screen mode

Tap .

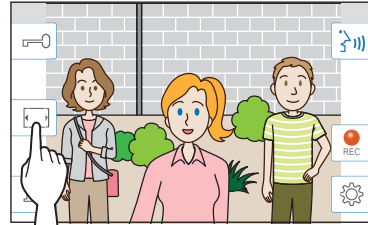

The display size is extended and the icons are hidden from the screen.

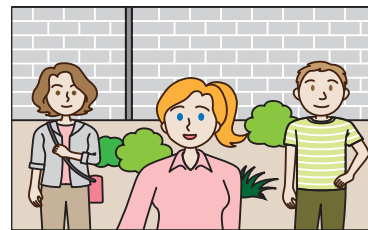

■ To restore the normal display mode.

Tap the screen.

* The screen automatically returns to the normal display mode after 10 seconds.

Communication using touch-to-talk

Touch-to-talk is a method of communication in which manual control of incoming and outgoing audio is used. Touch-to-talk is recommended in loud or noisy environments.

Tap .

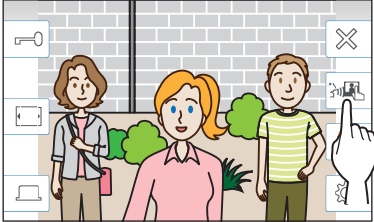

The touch-to-talk method is enabled.



◆ To speak, tap .

The  will change to .

* Door station audio is muted.



◆ To listen, tap .

* The  will change to .

* Master monitor station audio is muted.



Recording

Automatic recording

The station automatically records video and sounds at the door station after the elapse of a certain period of time after receiving a call.

While recording,  changes to .



- * The recording time is up to 10 seconds.
- * When the communication ends, the recording also ends.

NOTE:

- Automatic recording cannot be cancelled.
- Automatic recording does not begin while monitoring a door station. To record video while monitoring, use the manual recording method.
- If answered with a mobile device during automatic image and sound recording, the sound recording will end in the middle.

Manual recording

Video can be manually recorded during communication.

Tap  when a video is displayed.

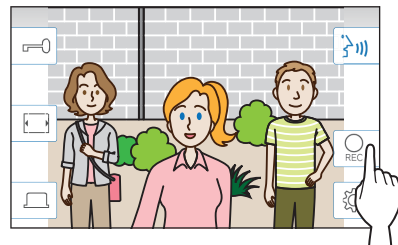

- * Manual recording is possible only when  is shown on the screen.
- * The recording quality is the same as automatic recording.

NOTE:

Manual recording cannot be performed during automatic recording.

More Information

- The recordings are stored in a microSDHC card. If a microSDHC card is not installed, recordings are saved in the built-in memory. Up to 10 recordings can be saved in the built-in memory.
- The recording time is up to 10 seconds per recording.
- The status LED will flash when there are recordings that have not been played yet. The LED will turn off when the MENU screen is shown.
- Up to 1,000 recordings will be possible when using a microSDHC card with enough capacity. When the number of recordings is reached to the maximum, the oldest recording will be deleted.

Monitoring the door station

1 From the MENU screen, tap .

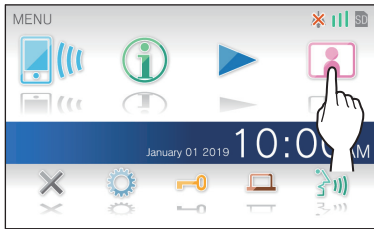

Video and audio from the door station will be received at the master monitor station.

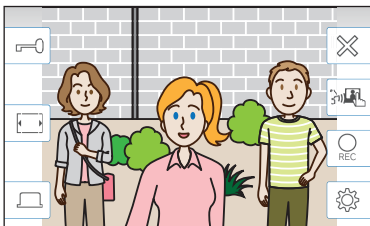







* Audio from the master monitor station is muted.

2 To end monitoring, tap .

* The monitoring will end automatically after the elapse of about 60 seconds from the start of monitoring.

Available functions during monitoring

-  : Talk (→ P. 18)
-  : Door release (→ P. 18)
-  : Manual recording (→ P. 20)
-  : Adjusting the screen brightness and receiving volume (→ P. 19)
-  : Changing to the full-screen mode (→ P. 19)
-  : Activating the external unit such as lightning equipment (→ P. 18)

NOTE:

Keep a distance of more than 20 cm (7-7/8") from person's body while monitoring.

Playing recordings

Screens and icons

Recording list

The recordings are shown in order.

* When a microSDHC card is installed, only the recordings in a microSDHC card will be shown. To display the recordings stored in the built-in memory, remove the microSDHC card.

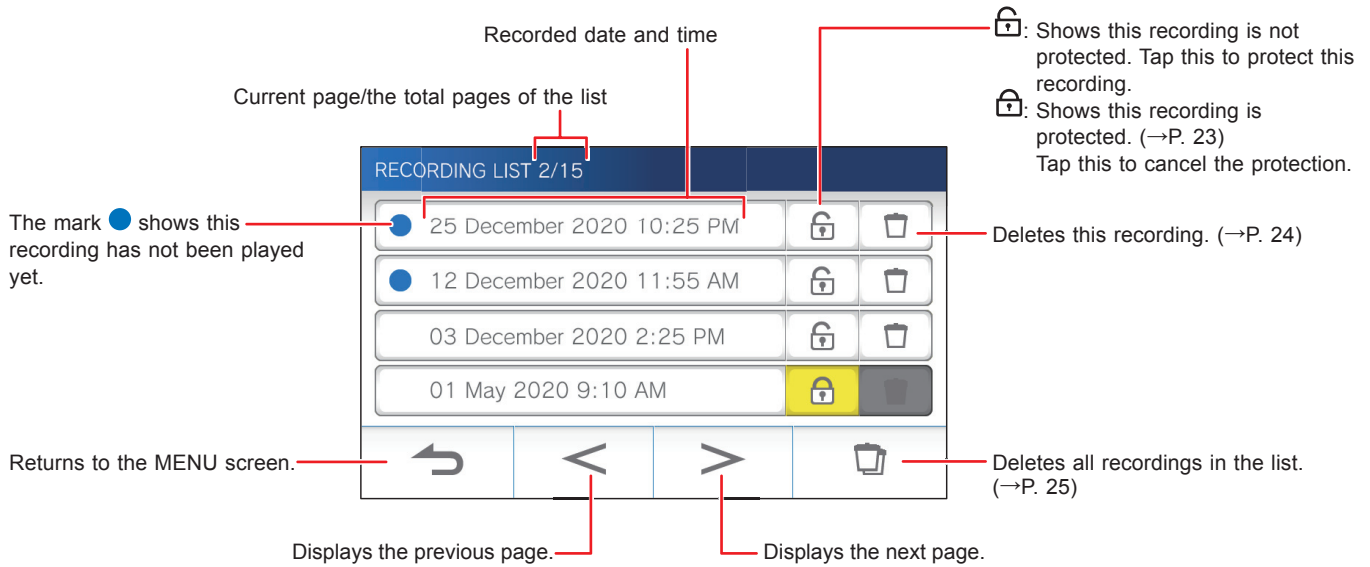

During play or play standby

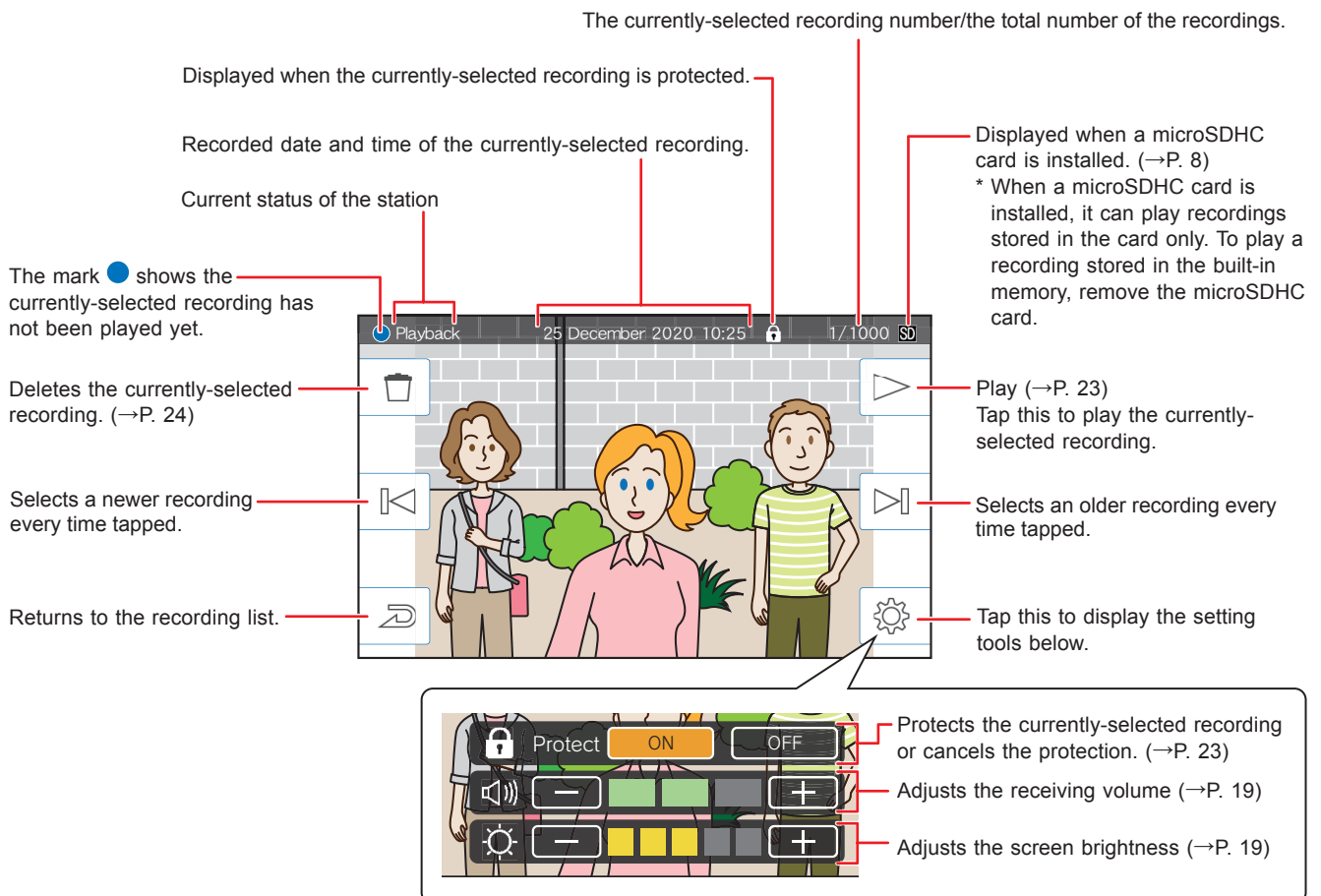

Playing recordings

1 From the MENU screen, tap .

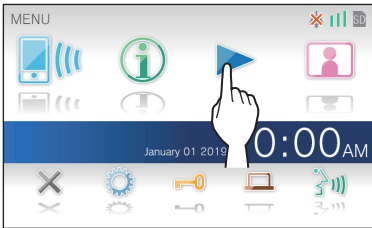

The recording list screen will be shown.

2 Tap the recording to view.

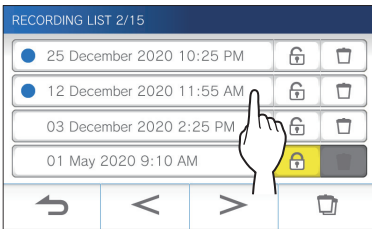

The standby screen of the selected recording will be shown.

* Tap  or  to change the pages of the list.

3 To play, tap .

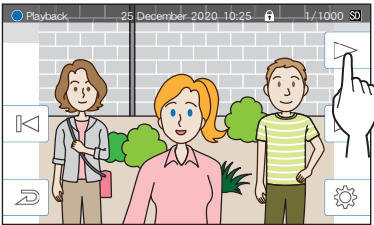

* The icons shown can be used while viewing the recording. (→ P. 22)

4 To cancel playing, tap .

NOTE:

- The station can only play video files recorded by the station. A video file loaded onto a microSDHC card by another device cannot be viewed.
- When a microSDHC card is installed in the station, you can play videos stored in the microSDHC card only. To play a video stored in the built-in memory, remove the microSDHC card.
- If you resume playing a recording after a pause, only the video will start playing and the audio will not be played.

Protecting recordings

Protect recordings from being accidentally overwritten.

To protect a recording on the recording list

1 From the MENU screen, tap .

The recording list screen will be shown.

2 Tap  of the recording to protect.

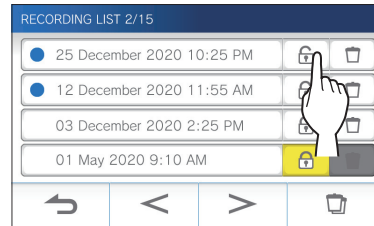

 : Shows this recording is protected.

Tap this to cancel the protection.

 : Shows this recording is not protected.

Tap this to protect this recording.

To protect the currently-selected recording while in standby

1 While in standby, tap .

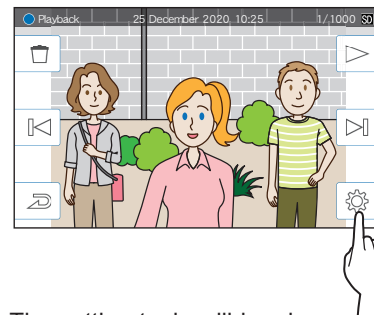

The setting tools will be shown.

2 Tap **ON**.



 will be shown.



■ To cancel the protection of the currently-selected recording

1 While in standby, tap .

2 Tap **OFF**.

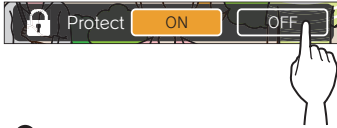

 will disappear to show the selected recording is no longer protected.

NOTE:

- A protected recording cannot be manually deleted or overwritten by a new recording.
- The maximum number of recordings that can be protected differs depending on the storage.
 - microSDHC card: up to 100
 - Built-in memory: up to 5
- If the number of the protected recordings exceeds the maximum, "Cannot protect. Max 100." is shown (if an SDHC card is not inserted, "Cannot protect. Max 5" is shown), and no further recordings can be protected.

Deleting a recording

NOTE:

A protected recording cannot be deleted. To delete, the protection must be removed.

To delete a recording

■ To delete a recording from the recording list

1 On the recording list, tap  icon of the recording to delete.

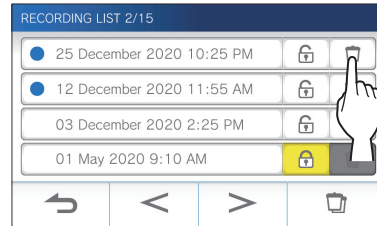

A confirmation screen will be shown.

2 To delete, tap **YES**.

The recording will be deleted.

* To cancel deleting, tap **NO**.

■ To delete the currently-selected recording in standby

1 In standby, tap .

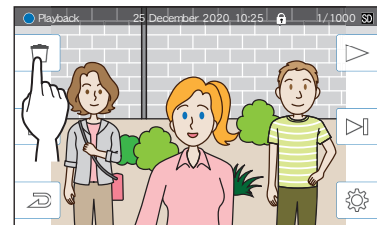

A confirmation screen will be shown.

2 To delete, tap **YES**.

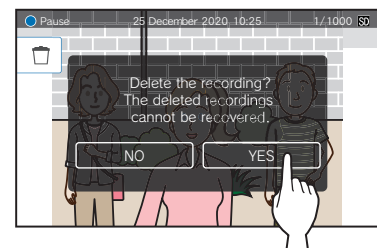

The selected recording will be deleted.

* To cancel deleting, tap **NO**.

To delete all recordings

Deleting all the recordings can be performed separately to microSDHC card and the built-in memory.

- 1 Insert the microSDHC card into the master monitor station.

To delete all the recordings in the built-in memory, remove any microSDHC card inserted in the master monitor station.

- 2 On the recording list, tap .

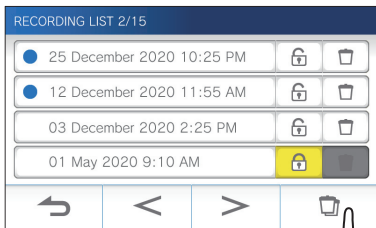

A confirmation screen will be shown.

- 3 To delete, tap **YES**.

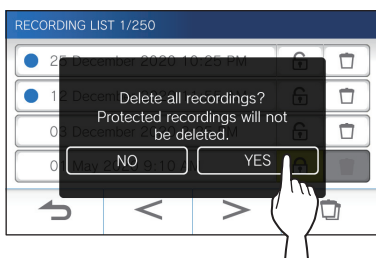



* To cancel, tap **NO**.

NOTE:

Protected recordings will not be deleted.

Copying recordings from the built-in memory onto a microSDHC card

- 1 From the MENU screen, tap  →  → **Other Settings**.

A message will appear asking whether or not to proceed.

- 2 To proceed, tap .

- 3 Tap **microSDHC card** → **Export recordings to microSDHC card**.

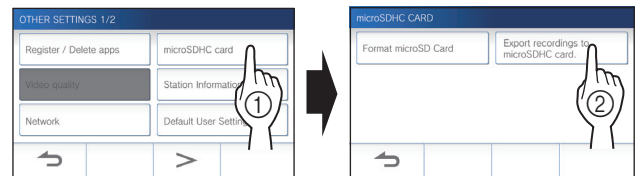

A confirmation screen will be shown.

- 4 Tap  to continue copying.

* To cancel, tap .

When "Recordings have been exported." is shown, copying has been completed.

* When completed, an "EXPORT" folder is created on the microSDHC card, and a folder with a 9-digit numeric name (e.g. 000000001) is created in it. Copied recordings are stored with the following file names:

e.g.:

A1000000001.264 (video file)

9-digit number

A1000000001.odd (audio file)

NOTE:

- After copying, the original recordings remain in the built-in memory.
- This action will overwrite all the existing recordings in the "EXPORT" folder on the microSDHC card.
- If there is insufficient memory on the microSDHC card, the copied recordings cannot be stored and the message "microSDHC card capacity is insufficient. Initialize the microSDHC card or delete unnecessary data." will be displayed.
- The recordings copied onto a microSDHC card cannot be played on the station. Use a PC, etc. to play them.
- Recordings on a microSDHC card cannot be copied into the built-in memory.
- In order to play a recording on a PC, a special tool for recording and playback is necessary. It can be downloaded from the Aiphone website (www.aiphone.net).
- The timestamp of the exported recordings will be displayed in Coordinated Universal Time (UTC).

Notification

Checking for updates.

1 From the MENU screen, tap .

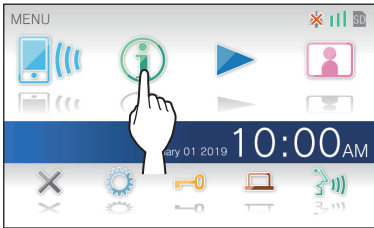

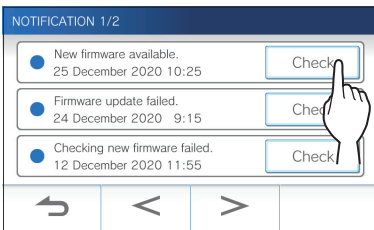

The notification list will be shown.

2 Tap **Check** of the notification to view.



The details of the notification will be shown.

- * The mark ● shows this notification has not been confirmed.
- * Tap  or  to change the pages of the list.

NOTE:

- Up to 5 notifications are shown in the list. If the 6th notification arrives, the oldest notification will be deleted.
- If you do not connect the station to the network, set **Automatic FW update** to **No Check**. (→ P. 34)

Settings list

The following are all of the available settings. These settings can be adjusted at any time.

Item	Details	Relevant page	
Brightness	Adjusts the screen brightness.	28	
Volume	Receive	Adjusts the receiving volume.	29
	Ringtone	Adjusts the incoming ringtone volume.	29
	Touch sounds	Enables or Disables the touch sound made whenever the touchscreen is used.	29
Date / Time	Current Time	Sets the current date and time.	7
	Date / Time Format	Sets the display format of date and time on the screen.	30
	Time Zone	Sets the time zone.	30
	Daylight Saving Time	Enables or disables daylight saving time.	31
Language	Sets the display language.	7	
Communication Timer	Sets the talk duration time.	31	
Cleaning Mode	Turns the screen into the cleaning mode.	39	
Door release / Option	Sets whether to display the door release icon and option output icon on the MENU screen.	32	
Notification LED	Sets whether to display (ON) the notification LED when a new notification arrives. * The icon on the MENU screen blinks when a new notification has arrived.	32	
Other Settings	Register / Delete apps	Registering a mobile device to, or deleting a mobile device from the master monitor station.	15
	microSDHC card	Formats a microSDHC card. Copies recordings from the built-in memory onto a microSDHC card.	9, 25
	Station Information	Displays firmware update notification for the master monitor station. Also allows configuration of automatic firmware updating for the master monitor station.	34
	Network	Configures network settings.	11
	Default User Settings	Initializes all the user settings to default.	35
	Regulatory	Displays the related regulations.	35
	Privacy Policy	Displays information about Protection of Personal Information.	35
	Administrator Settings	These settings had been completed at the system installation. Do not change the settings.	36
	Maintenance	Exports the operation log of the station to the microSDHC card.	36
	Door Release	Sets the unlocking duration time of the electric door lock.	36
	Option Output	Sets the option output duration time.	37
Factory Reset	Initializes all settings.	37	

NOTE:

- The station will enter standby mode after approx. one minute of no operation. If this occurs, any unfinished setting changes will be lost.
- For settings other than "**Other Settings**":
If an incoming call is received, any unfinished setting changes will be lost.
- For the settings in "**Other Settings**":
If there is a call during configuration, the station will not receive the call.
- The above list is a brief overview of the setting items available on the station. The descriptions, and the style and order of descriptions do not necessarily represent the full scope of the settings.

Adjusting screen brightness

Settings	1 to 5
Default	3

1 From the MENU screen, tap .

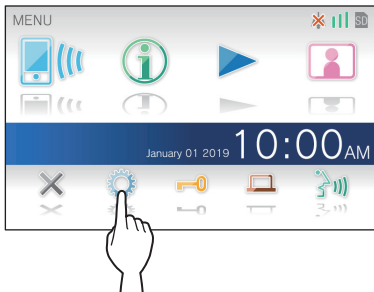

The SETTINGS 1/2 screen will be shown.

2 Tap **Brightness**.



The brightness adjusting bar will be shown.

3 Tap  to adjust the screen brighter, and  to adjust the screen darker.

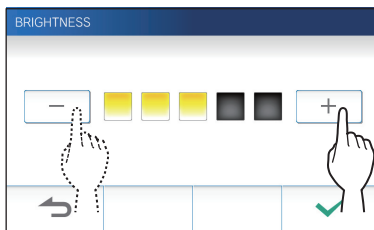

4 Tap  to apply changes.

Changing the sound settings

Adjusting receiving volume

Settings	1 to 3
Default	2

- 1 From the MENU screen, tap  → **Volume** → **Receive**.

The volume adjusting bar will be shown.

- 2 Tap **+** to adjust the volume higher, and **-** to adjust the volume lower.

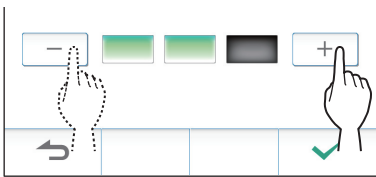

- 3 Tap to apply changes.

Adjusting ringtone volume

Settings	0 to 3
Default	2

- 1 From the MENU screen, tap  → **Volume** → **Ringtone**.

The volume adjusting bar will be shown.

- 2 Tap **+** to adjust the volume higher, and **-** to adjust the volume lower.

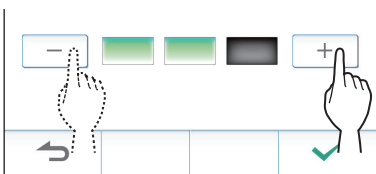

- 3 Tap to apply changes.

Enabling/Disabling the touch sound

Enable (ON) or disable (OFF) the touch sound made whenever the touchscreen is used.

Settings	ON/OFF
Default	ON

- 1 From the MENU screen, tap  → **Volume** → **Touch sounds**.

- 2 Tap **ON** to enable or **OFF** to disable the touch sound.

- 3 Tap to apply changes.

Changing the time settings

Setting the current date and time

(→ P. 7)

Selecting the display format of the date and time

Select the display format of the date and time on the screen.

Settings	Display example
mm/dd/yyyy(12h)	January 25 2020 10:25 PM (12-hour notation)
mm/dd/yyyy(24h)	January 25 2020 22:25 (24-hour notation)
dd/mm/yyyy(12h)	25 January 2020 10:25 PM (12-hour notation)
dd/mm/yyyy(24h)	25 January 2020 22:25 (24-hour notation)

Default: mm/dd/yyyy(12h)

1 From the MENU screen, tap  → **Date/Time**
→ **Date / Time Format**.

2 Tap the preferred display format.

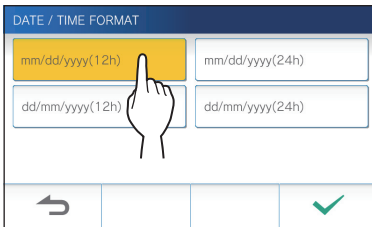

3 Tap to apply changes.

Setting the time zone

1 From the MENU screen, tap  → **Date/Time**
→ **Time Zone**.

2 Tap the proper time zone from the list of time zones.

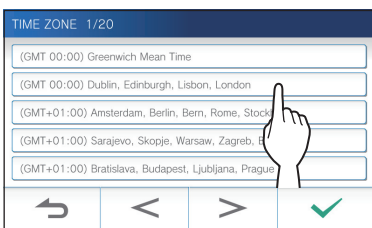

* Tap or to change the pages of the list.

3 Tap to apply changes.

* When one of the following time zone is set, the daylight saving time setting is automatically applied, so set

Daylight Saving Time to **None** (→ P. 31).

List of time zones
(GMT-10:00) Alaska (Adak)
(GMT-09:00) Alaska
(GMT-08:00) Pacific Standard Time (U.S.), Tijuana
(GMT-08:00) Pacific Standard Time (Canada)
(GMT-07:00) Mountain Standard Time (U.S., Canada)
(GMT-06:00) Mexico City
(GMT-06:00) Central Standard Time (U.S., Canada)
(GMT-05:00) Eastern Indiana
(GMT-05:00) Eastern Standard Time (U.S., Canada)
(GMT-04:00) Santiago
(GMT-04:00) Atlantic Standard Time (Canada)
(GMT-03:30) Newfoundland
(GMT-03:00) Greenland
(GMT-03:00) Buenos Aires
(GMT-03:00) Brasilia
(GMT-01:00) Azores
(GMT 00:00) Dublin, Edinburgh, Lisbon, London
(GMT+01:00) Amsterdam, Berlin, Bern, Rome, Stockholm
(GMT+01:00) Sarajevo, Skopje, Warsaw, Zagreb, Belgrade
(GMT+01:00) Bratislava, Budapest, Ljubljana, Prague
(GMT+01:00) Brussels, Madrid, Copenhagen, Paris
(GMT+02:00) Sofia, Vilnius
(GMT+02:00) Athens, Istanbul
(GMT+02:00) Jerusalem
(GMT+02:00) Cairo
(GMT+02:00) Bucharest
(GMT+02:00) Helsinki, Riga, Tallinn
(GMT+03:00) Tehran
(GMT+09:30) Adelaide
(GMT+10:00) Canberra, Melbourne
(GMT+10:00) Sydney
(GMT+10:00) Hobart
(GMT+12:00) Auckland, Wellington

Setting daylight saving time

Set whether to utilize daylight saving time (+1(h)) or not (None).

Settings	Description
None	Daylight saving time is not utilized.
+1(h)	Daylight saving time is utilized for 1 hour.

- From the MENU screen, tap  → **Date/Time** → **Daylight Saving Time**.
- Set whether to utilize daylight saving time.

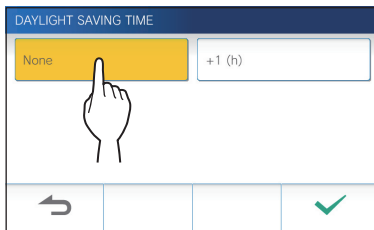

- Tap to apply changes.

Changing the display language

(→ P. 7)

Setting the talk duration time

Settings	60 sec./180 sec.
Default	60 sec.

- From the MENU screen, tap  → **Communication Timer**.
- Tap **60 sec.** or **180 sec.**.

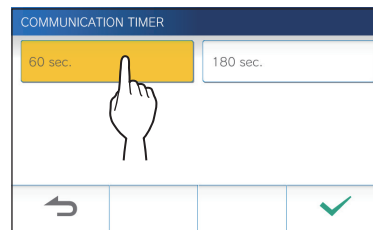

- Tap to apply changes.



Cleaning mode

(→ P. 39)

Setting of door release/option

Set whether to display the door release icon and option output icon on the MENU screen.

	Door release	Option output
Settings	Enable/Disable	Enable/Disable
Default	Enable	Enable

- 1 From the MENU screen, tap  →  → **Door release / Option**.

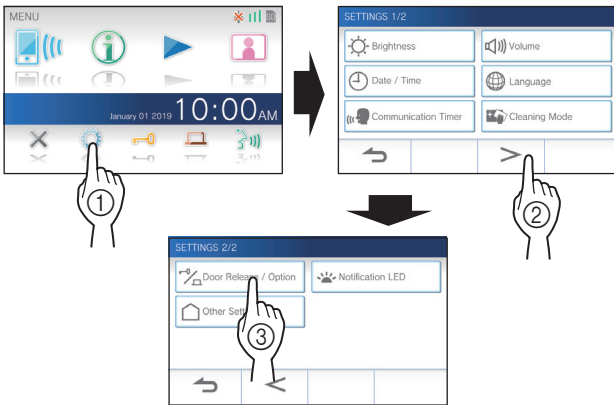

- 2 Tap **Enable** to display the icon, or **Disable** to hide the icons.

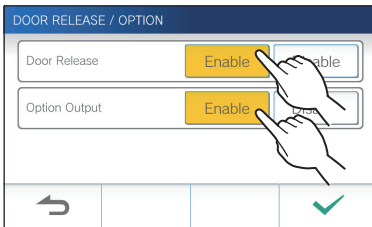

- 3 Tap  to apply changes.

Setting of notification LED

Set whether to display (ON) the notification LED when a new notification arrives.

Settings	ON/OFF
Default	ON

- 1 From the MENU screen, tap  →  → **Notification LED**.

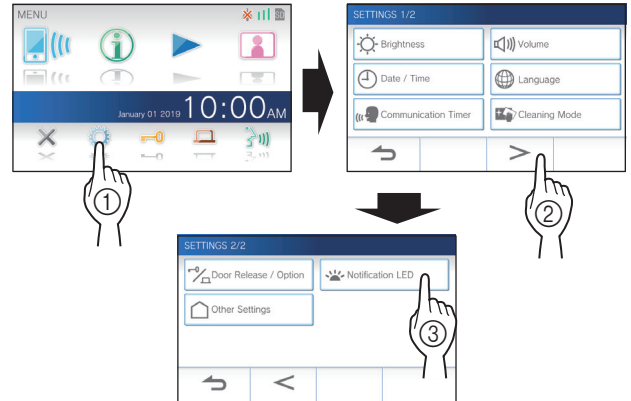

- 2 Tap **ON** to turn notification LED on, or **OFF** to turn the notification LED off.

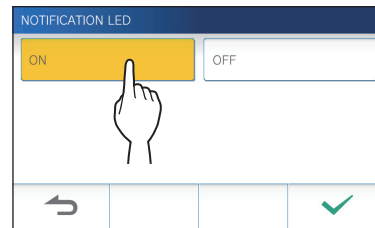

- 3 Tap  to apply changes.

Other settings

⚠ ATTENTION:

While configuring the settings in "Other Settings", the station will not respond to an incoming call and will not sound ringtone.

Registering/Deleting a mobile device

- **Downloading the App to the mobile device**
(→ P. 15)
- **Registering a mobile device to the station**
(→ P. 15)
- **Deleting the mobile device from the station**
(→ P. 17)



Setting a microSDHC card

- **Formating a microSDHC card** (→ P. 9)
- **Copying recordings from the built-in memory onto a microSDHC card** (→ P. 25)

Viewing station information

View a notification for updating the firmware of the station. If an update is available, continue to update the station. It is also possible to configure the settings to automatically update the station.

Viewing a notification for updating the station

- 1 From the MENU screen, tap  →  → **Other Settings**.

A message will appear asking whether or not to proceed.

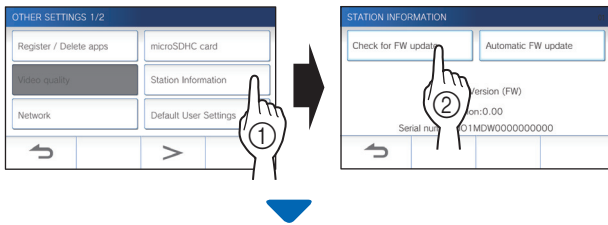

- 2 To continue, tap .

- 3 Tap **Station Information** → **Check for FW Update**.



When updating is available

A message will appear and to ask whether to update the station.

- To update, tap  after reading the message carefully.
 - * When the updating has been completed, the station will reboot after 5 seconds, and then returns to the MENU screen.
 - * If the update has failed, an  icon will appear along with the cause of the failure will be shown.
- To cancel update, tap .

When the firmware is up to date

A message will appear to show the firmware is up to date.

- Tap  to return to **Station Information**.

Configuring the settings for automatically updating the station

- * To enable the automatic update, the station must be connected to the network. The station and the server will communicate periodically for updating.

Settings	Update Automatically/Notify Only/No Check
Default	Notify Only

- 1 From the MENU screen, tap  →  → **Other Settings**.

A message will appear asking whether or not to proceed.

- 2 To continue, tap .

- 3 Tap **Station Information** → **Automatic FW update**.

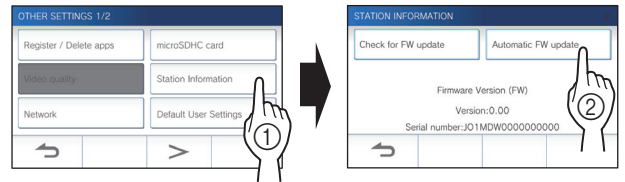

- 4 Tap one of the selections below.

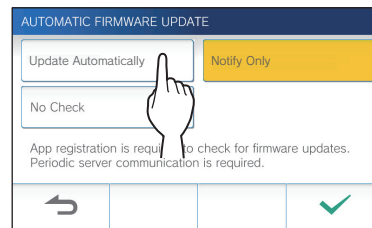

Update Automatically :

Select this to enable the automatic update.

- * The update will happen without prior notice. While updating, all the functions of the station will not be properly function, including receiving an incoming call.

Notify Only :

Select this to be notified only about the latest firmware and update at a desired time.

The notification can be confirmed by tapping  on the MENU screen. (→ P. 38)

No Check :

Select this if you do not want both automatic update and notification when the station is connected to the network. (→ P. 38)

Select this if you do not connect the station to the network.

- 5 Tap  to apply settings.



Configuring network settings

- Connecting using "Auto Connect (WPS)" (→ P. 11)
- Connecting using "Manual Setup"(→ P. 11)
- Confirming the current network settings (→ P. 12)
- Other Wi-Fi settings (→ P. 13)

Initializing user settings

This will reset all the settings to default, except for the following.

- Administrator settings
- Recordings stored in a microSDHC card and the built-in memory

- 1 From the MENU screen, tap  →  → **Other Settings**.

A message will appear asking whether or not to proceed.

- 2 To continue, tap .

- 3 Tap **Default User Settings**.

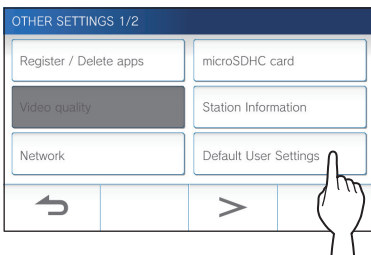

A message will appear asking whether or not to proceed.



- 4 To continue initializing the user settings, tap .

When "The user settings have been reset." is shown, the initializing has been completed, and will return to the screen of step 3.

NOTE:

It is recommended that user settings, recordings and logs are deleted if ownership of this station changes. (→ P. 37)

Confirming the related regulations

- 1 From the MENU screen, tap  →  → **Other Settings**.

A message will appear asking whether or not to proceed.

- 2 To continue, tap .

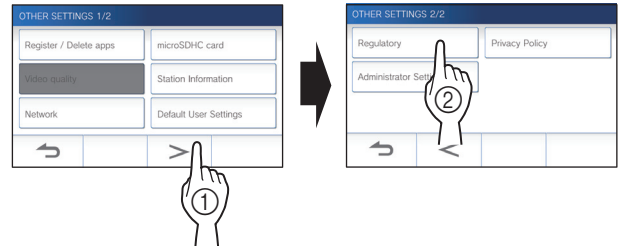

- 3 Tap  → **Regulatory**.



The related regulations will be shown.

- 4 After confirmation, tap  to return to the **OTHER SETTINGS 1/2** screen.

Confirming information about Protection of Personal Information

- 1 From the MENU screen, tap  →  → **Other Settings**.

A message will appear asking whether or not to proceed.

- 2 To continue, tap .

- 3 Tap  → **Privacy Policy**.

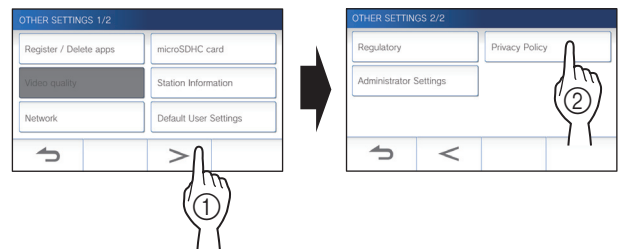

"Please read the end user license agreement in the app." is shown. Confirm the contents with the INTERCOM APP Type B and select "Agree" or "Disagree".

- 4 After confirmation, tap  to return to the **MENU** screen.



NOTE:

If the station is not connected to the network, you cannot confirm Privacy Policy.

Administrator settings

These settings had been completed at the system installation. Do not change the settings.

Exporting the log file to the microSDHC card

- 1 From the MENU screen, tap  →  → **Other Settings**.

A message will appear asking whether or not to proceed.

- 2 To continue, tap .

- 3 Tap  → **Administrator Settings**.

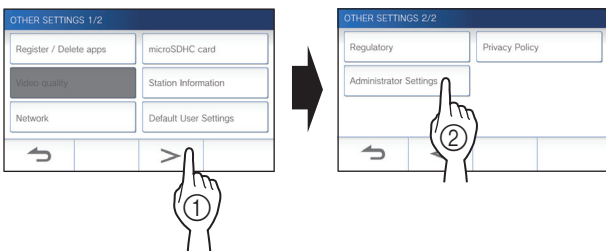

A message will appear asking whether or not to proceed.

- 4 To continue, tap .

- 5 Tap **Maintenance**.

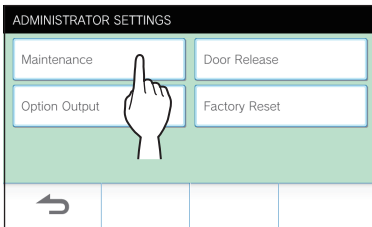

- 6 Tap **Export Logs**.

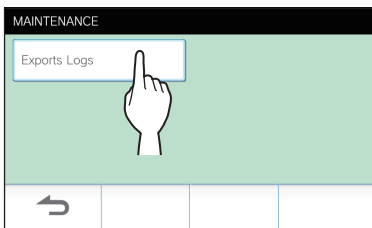



- 7 To continue, tap .

* To cancel, tap .

When "The log data has been exported." is shown, exporting has been completed.

Setting Door Release duration

Settings	1 to 30 (sec.)
Default	5

- 1 From the MENU screen, tap  →  → **Other Settings**.

A message will appear asking whether or not to proceed.

- 2 To continue, tap .

- 3 Tap  → **Administrator Settings**.

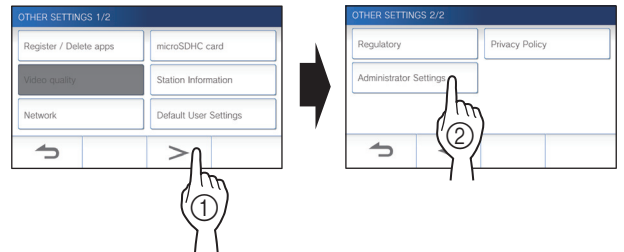

A message will appear asking whether or not to proceed.

- 4 To continue, tap .

- 5 Tap **Door release**.

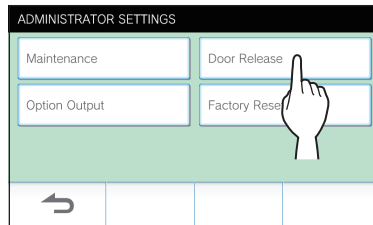

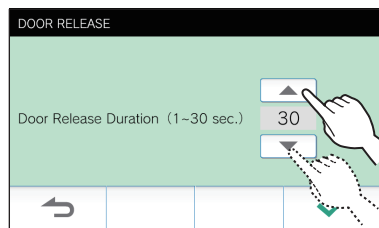

- 6 Tap  or  to adjust the door release duration.



- 7 Tap  to apply changes.

Setting Option Output duration

Settings	1 to 30 (sec.)
Default	5

- From the MENU screen, tap  →  → **Other Settings**.

A message will appear asking whether or not to proceed.

- To continue, tap .

- Tap  → **Administrator Settings**.

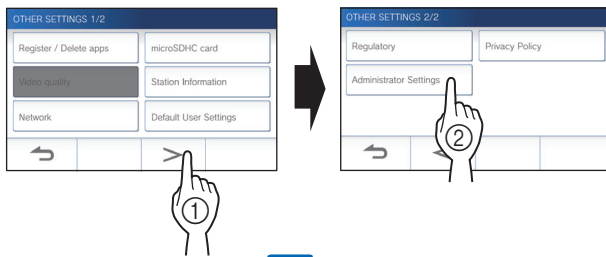



A message will appear asking whether or not to proceed.

- To continue, tap .

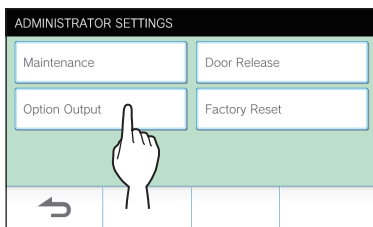
- Tap **Option Output**.



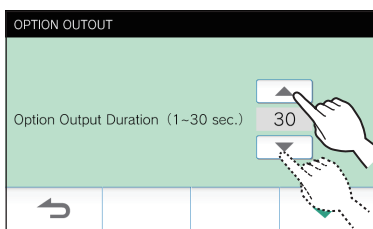

- Tap  or  to adjust the option output duration.



- Tap  to apply changes.

Restoring all settings to the factory default

* This operation also deletes all the recordings including protected ones.

- From the MENU screen, tap  →  → **Other Settings**.

A message will appear asking whether or not to proceed.

- To continue, tap .

- Tap  → **Administrator Settings**.

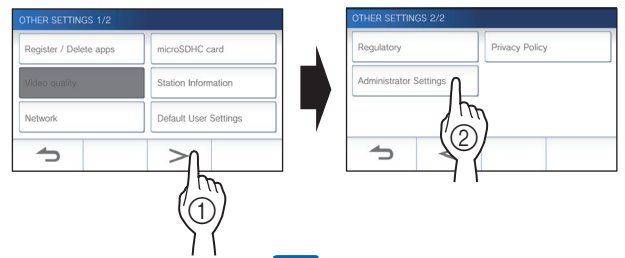

A message will appear asking whether or not to proceed.

- To continue, tap .

- Tap **Factory Reset**.

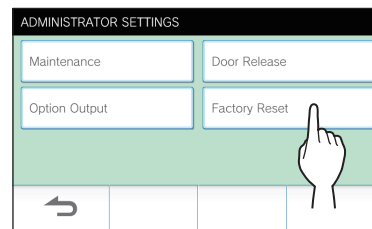

- Tap  to continue initializing the settings.

* To cancel, tap .

When "The station has been initialized." is shown, the initializing has been completed, and will return to the screen of step 5.

NOTE:

It is recommended that user settings, recordings and logs are deleted if ownership of this station changes.

FOR PROPER USE OF THE STATION

Updating a firmware of the station

The firmware of the station must be updated periodically. The following methods are available for updating.

- Automatic update through the network.
- Receiving a notification for available updates through the network.
- Updating the station by using a microSDHC card on which the newest version of the firmware is stored.

NOTE:

For selecting the updating method, see "Configuring the settings for automatically updating the station" (→ P. 34)

⚠ ATTENTION:

- While updating, the station will not respond to an incoming call and will not sound ringtone.
- Do not turn off power during updating.

Automatic update through the network

An update is automatically performed when the station detects the newest firmware.

⚠ ATTENTION:

The updating is performed without prior notice.

Receiving a notification for available updates through the network

Use this method when updating the station manually.

- 1 From the MENU screen, tap .

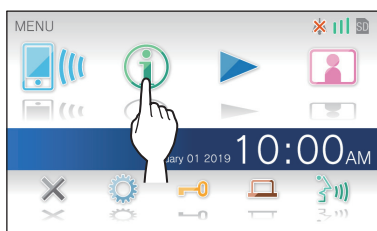

The notification list will be shown.

- 2 Tap **Check** of the notification "There is a new version."

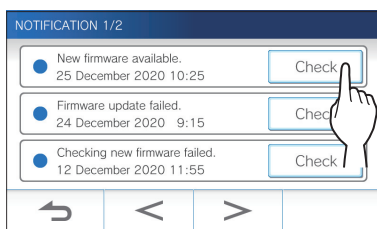

A message will appear to ask whether you will update the station.

- * If you do not connect the station to the network, set **Automatic FW update** to **No Check**. (→ P. 34)

- 3 To update, tap .

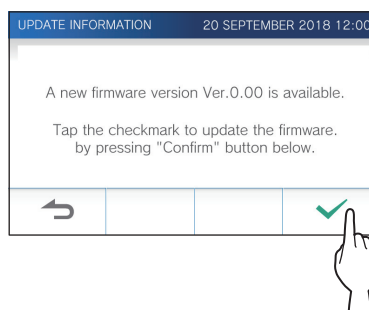

- 4 Tap .

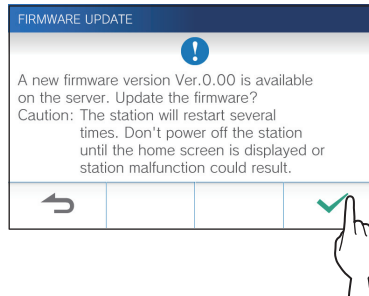

The updating begins.

When "The firmware has been updated. The station will restart in 5 sec." is shown, the update has been completed, and the station reboots after 5 seconds.

Updating the station by using a microSDHC card on which the newest version of the firmware is stored

Use this method when the station is not connected to the network.

In advance, download the newest version of the firmware from the Aiphone website to a microSDHC card.

1 Install a microSDHC card on which the newest version of the firmware is stored.

A message appears to show whether the microSDHC card has been recognized.

2 When the microSDHC card is recognized, tap .

A message appears to ask whether to update the station.

3 To perform the updating, tap .

The updating begins.

When "The firmware has been updated. The station will restart in 5 sec." is shown, the updating has been completed, and the station reboots after 5 seconds.

Cleaning

Cleaning the exterior surfaces

Clean the station with a soft cloth dampened with a neutral household cleanser. Do not use any abrasive cleaner or cloth.

CAUTION:

Do not use chemicals such as thinner or benzine. In addition, do not use a scrub brush, sandpaper, etc. The station surface could be damaged or discolored.

Cleaning the screen

1 From the MENU screen, tap → **Cleaning Mode**.

The screen will turn into the cleaning mode.

2 Clean the screen while the screen below is shown (for about 10 seconds).

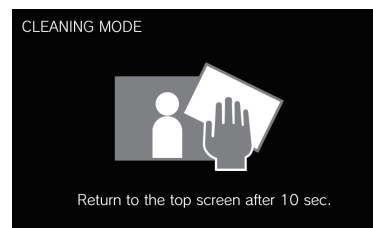

* To wipe off dirt on the screen, use a commercially-available eyeglass cleaning cloth etc.



The screen returns to the MENU screen after 10 seconds.

NOTE:

The CLEANING MODE screen is shown while you are touching the screen. It returns to the MENU screen about 15 seconds after touching is finished.

Troubleshooting

If issues with the station occur, refer to the following information to determine whether the issue can be corrected by the suggested testing and solutions. For further help and assistance, contact your installer or service provider.

Problem	Cause	Solution	Page
The screen is black.	The monitor is off in standby mode.	The monitor turns on by touching the screen.	6
The screen is white or displaying white vertical lines or rings.	The lens of the door station is in direct sunlight or another bright light source. (This is not a malfunction.)	Install the door station in a location where it is not pointing direct sunlight.	—
The screen is too dark or too bright, and it is difficult to view.	The screen brightness may be incorrectly set.	Adjust the screen brightness.	19, 28
The ringtone from the door station does not sound.	The ringtone volume is set to "0".	Adjust the ringtone volume.	29
Communication cannot be heard even if  is tapped.	The receiving volume is set to "1".	Adjust the receiving volume during communication.	19
Communication is interrupted, or it becomes a one-way conversation.	Loud sounds around the station or the door station.	Because of auto-voice actuation, audio may be interrupted when a surrounding sound is loud. In that case, enable the touch-to-talk method.	20
The other party cannot hear your voice at all (but can hear the other party's voice).	The touch-to-talk is selected.	When using touch-to-talk, the visitor can only hear incoming audio if the user is tapping  .	20
The station has a black screen and does not respond to touch.	The power may be off.	Contact your installer or service technician.	—
The status LED is flashing during standby.	There may be recordings that have not been played or notifications that have not been confirmed.	Check the related page in addition to the indication patterns of the status LED.	5
Recording is not possible.	A memory card that cannot be used on the station is installed.	Install a microSDHC card complying with the SD standard.	8
	There is a damage or dirt on the microSDHC card.	Replace the microSDHC card.	8
A notice of firmware confirmation failure is shown in the notification list.	A network error has occurred (e.g. router power-off, external network error).	Confirm the network settings and the equipment used.	—
	The network setting is not configured.	If you do not connect the station to the network, set Automatic FW update to No Check .	34

Technical precautions

- The video image may distort when door release is activated. This is not a station malfunction.
- If you resume playing a recording after a pause, only the video will start playing and the audio will not be played.
- If door release operation or option is performed during communication with the door station, noise will be produced at the door station. This is not a malfunction.
- If there is a system malfunction, contact a qualified technician for service.

Specifications

Power supply	DC18V (from power supply)
Current consumption	(MAX) Approx. 450mA
Communication	Hands-free (Auto-voice actuation)
	Touch-to-talk
Ambient temperature	0 - 40°C (32°F - 104°F)
Wireless LAN interface	IEEE802.11b/g/n
Screen	7 inch TFT LCD touch screen

Mounting	Wall-mount
Material	Self-extinguishing resin
Color	White
Dimensions	155 (H) × 210 (W) × 27 (D) (mm) 6-1/8 (H) × 8-1/4 (W) × 1-1/16 (D) (inches)
Mass	Approx. 620 g (1.37 lbs.)

Regulations

FCC

This device complies with part 15 of the FCC Rules. Operation is subject to the following two conditions: (1) This device may not cause harmful interference, and (2) this device must accept any interference received, including interference that may cause undesired operation.

Changes or modifications not expressly approved by the party responsible for compliance could void the user's authority to operate the equipment.

NOTE: This equipment has been tested and found to comply with the limits for a Class B digital device, pursuant to part 15 of the FCC Rules. These limits are designed to provide reasonable protection against harmful interference in a residential installation. This equipment generates, uses and can radiate radio frequency energy and, if not installed and used in accordance with the instructions, may cause harmful interference to radio communications. However, there is no guarantee that interference will not occur in a particular installation. If this equipment does cause harmful interference to radio or television reception, which can be determined by turning the equipment off and on, the user is encouraged to try to correct the interference by one or more of the following measures:

- Reorient or relocate the receiving antenna.
- Increase the separation between the equipment and receiver.
- Connect the equipment into an outlet on a circuit different from that to which the receiver is connected.
- Consult the dealer or an experienced radio/TV technician for help.

INDUSTRY CANADA

CAN ICES-3 (B)/NMB-3(B)

This device contains licence-exempt transmitter(s)/receiver(s) that comply with Innovation, Science and Economic Development Canada's licence-exempt RSS(s). Operation is subject to the following two conditions:

- (1) This device may not cause interference.
- (2) This device must accept any interference, including interference that may cause undesired operation of the device.

RED

Hereby, Aiphone Co., Ltd. declares that the radio equipment type [JO-1MDW] is in compliance with Directive 2014/53/EU.

The full text of the EU declaration of conformity is available at the following internet address:

<https://www.aiphone.net/>

2412 - 2472MHz Max.15.5dBm

WEEE



The object area of  is the EU.

Warranty

Aiphone warrants its products to be free from defects of material and workmanship under normal use and service for a period of 2 years after delivery to the ultimate user and will repair free of charge or replace at no charge, should it become defective upon which examination shall disclose to be defective and under warranty. Aiphone reserves unto itself the sole right to make the final decision whether there is a defect in materials and/or workmanship; and whether or not the product is within the warranty. This warranty shall not apply to any Aiphone product which has been subject to misuse, neglect, accident, power surge, or to use in violation of instructions furnished, nor extended to units which have been repaired or altered outside of the factory. This warranty does not cover batteries or damage caused by batteries used in connection with the unit. This warranty covers bench repairs only, and any repairs must be made at the shop or place designated in writing by Aiphone. This warranty is limited to the standard specifications listed in the operation manual. This warranty does not cover any supplementary function of a third party product that is added by users or suppliers. Please note that any damage or other issues caused by failure of function or interconnection with Aiphone products is also not covered by this warranty. Aiphone will not be responsible for any costs incurred involving on site service calls. Aiphone will not provide compensation for any loss or damage incurred by the breakdown or malfunction of its products during use, or for any consequent inconvenience or losses that may result.

