

## Product Overview

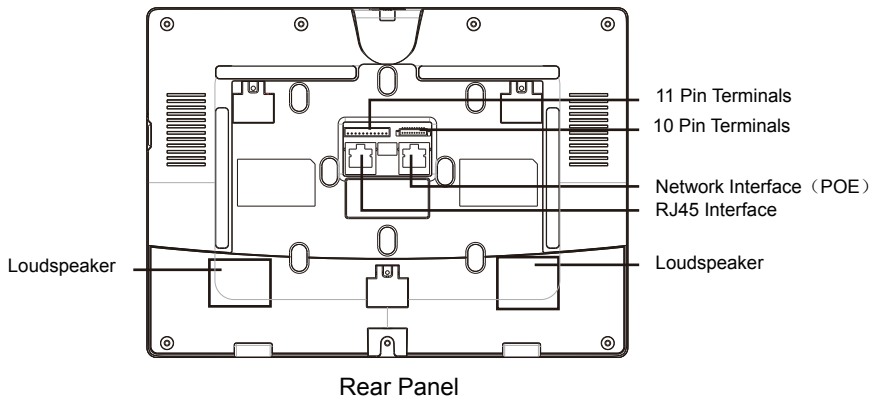

## Unpacking

Please make sure the package contains the following items:

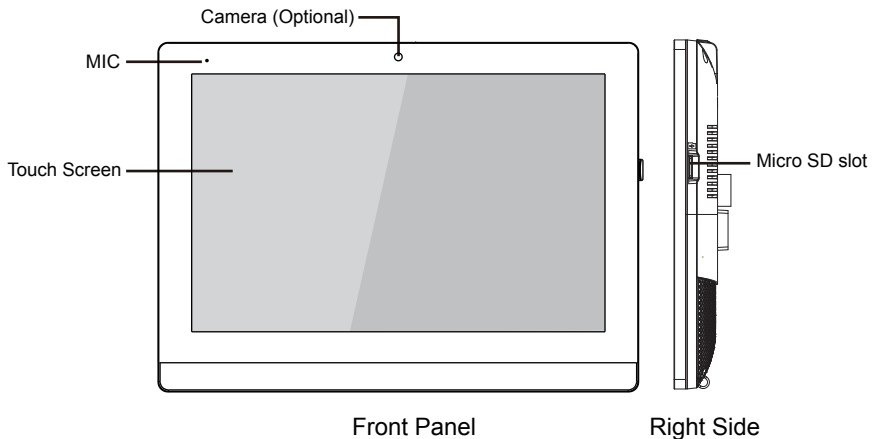
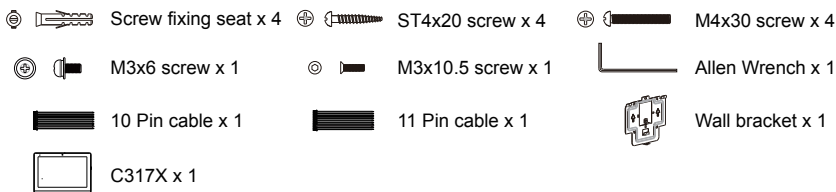

## Installation

### Step 1: Wall Bracket Installation Without embedded box in the wall

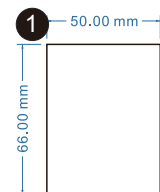

1 According to the position of the cable in the wall, dig out a square hole (height\*width\*depth =66\*50\*50mm) that can accommodate all cables.

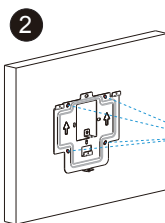

2 Align the square hole of the wall bracket with the hole dug out before, then mark the four fixation holes through bracket on the wall.

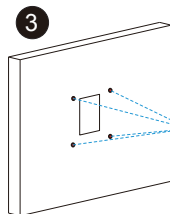

3 Take down the bracket, then using a 5mm hand drill to make the four fixation holes on the wall which marked before.

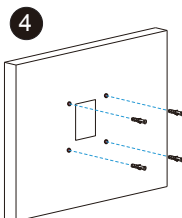

4 Once the fixation holes were made, insert screw fixing seats provided.

# C317X Quick Guide

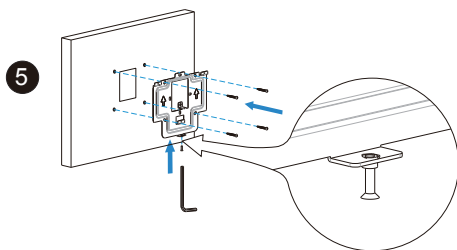

Twist M3x10.5 screw into the bottom hole of the bracket until the tail of which align to the edge. Then fix the wall bracket on the wall with four ST4x20 screws. If there is a earth wire to be connected, use M3x6 screw to fix it on the wall bracket.

## With embedded box in the wall

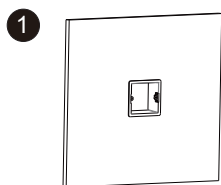

Make sure all cables in the embedded box .

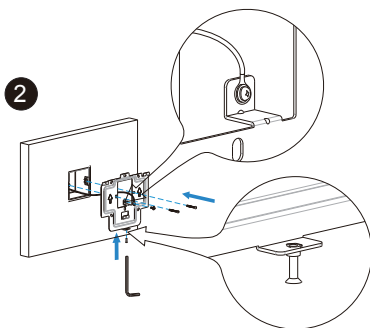

Twist M3x10.5 screw into the bottom hole of the wall bracket until the tail of which align to the edge. Then fix the wall bracket on the wall with two/four M4x30 screws. If there is a earth wire to be connected , use M3x6 screw to fix it on the wall bracket.

## Step 2: Device Mounting

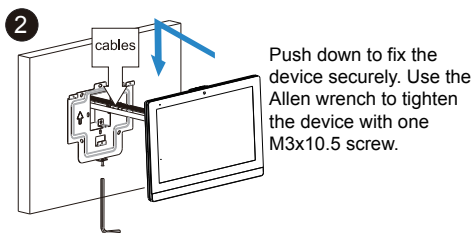
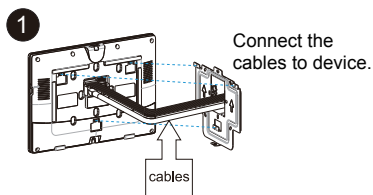



## Configuration

1. Access basic information: After setting up network and power, enter **More -> System Info** to check Account, Network, Version status.
2. Access the Website: Launch a browser and type in the IP address then enter the username and password to login. (username/password: admin /admin by default)
3. Account Registration: On web UI, go to the path: **Account -> Basic** page to fill in the account information, click Submit to confirm. (Please refer to user manual for more information)

## Operation

### Make a call:

Press Intercom icon , enter the callee's number or room address, then choose Audio  or Video  mode to make out.

### Receive a call:

Press  on the incoming interface to pickup the incoming call.

### Unlock

During the talk, called party can press Unlock Key  on the talking interface to unlock the door.

### Monitor

Press Live View icon  to receive the video from the IPC any time.

### Notice Information

*Information contained in this document is believed to be accurate and reliable at the time of printing. This document is subject to change without notice, any update to this document can be viewed on Akuvox's website: <http://www.akuvov.com> © Copyright 2019 Akuvox Ltd. All rights reserved.*

**AKUVOX (XIAMEN) NETWORKS CO., LTD.**

ADD: 10/F, NO.56 GUANRI ROAD, SOFTWARE PARK II, XIAMEN 361009, CHINA  
[www.akuvov.com](http://www.akuvov.com)



YS31700000