

Canon EF LENS

EF100-400mm f/4.5-5.6L IS II USM



IMAGE STABILIZER

 ULTRASONIC

ENG

Instructions

Thank you for purchasing a Canon product.

Equipped with an Image Stabilizer, the Canon EF100-400mm f/4.5-5.6L IS II USM is a high-performance telephoto zoom lens, for use with EOS cameras.

- “IS” stands for Image Stabilizer.
- “USM” stands for Ultrasonic Motor.

Features

1. Equipped with an Image Stabilizer that provides an image stabilization effect equivalent to a shutter speed 4 stops* faster (when the focal length is set to 400 mm and when used with the EOS-1D X).
Also, a third Image Stabilizer mode effective for shooting irregularly moving subjects.
2. Use of fluorite and Super UD lens elements giving superior definition.
3. ASC (Air Sphere Coating) reduces flare and ghosting.
4. Using a fluorine coating on the foremost and rearmost lens surfaces allows adhered dirt to be removed more easily than before.
5. Ultrasonic motor (USM) for fast, quiet autofocus.
6. Manual focusing is available after the subject comes into focus in autofocus mode (ONE SHOT AF).
7. Operational feel of the zoom ring can be adjusted.
8. Hood features circular polarizing filter adjustment window which allows adjustment of the circular polarizing filter while the hood is attached to the lens.
9. A tripod mount can be attached to the lens.
10. Circular aperture for producing beautiful softfocus images.
11. Can be used with EF1.4x III/EF2x III extenders.
12. Tight seal structure provides excellent dustproof and drip-proof performance. However, it is unable to provide complete protection from dust and moisture.

* Image stabilization performance based on CIPA (Camera & Imaging Products Association) Standards.

Safety Precautions

Handling Cautions

- **If the lens is taken from a cold environment into a warm one, condensation may develop on the lens surface and internal parts.** To prevent condensation in this case, first put the lens into an airtight plastic bag before taking it from a cold to warm environment. Then take out the lens after it has warmed gradually. Do the same when taking the lens from a warm environment into a cold one.
- Do not leave the lens in excessive heat such as in a car in direct sunlight. **High temperatures can cause the lens to malfunction.**
- When the lens is mounted on a camera, it is recommended that you also hold the camera by the lens, including when mounting it on a tripod.

Usage Precautions

- When using this lens, please check the Canon website for the latest camera firmware. If the camera's firmware is not the latest version, be sure to update to the latest firmware.
- For details on updating firmware, please check the Canon website.

Safety Precautions

- **Do not look at the sun or a bright light source through the lens or camera.** Doing so could result in loss of vision. Looking at the sun directly through the lens is especially hazardous.
- **Do not point the lens or camera at the sun or photograph it.** This is because the lens concentrates the sun's rays even when the sun is outside the image area or when shooting with backlight, which could cause malfunction or fire.
- **Whether it is attached to the camera or not, do not leave the lens under the sun without the lens cap attached.** This is to prevent the lens from concentrating the sun's rays, which could cause a fire.

Conventions used in this instruction



Warning to prevent lens or camera malfunction or damage.



Supplementary notes on using the lens and taking pictures.

Safety Precautions

This device complies with Part 15 of the FCC Rules.

Operation is subject to the following two conditions: (1) This device may not cause harmful interference, and (2) this device must accept any interference received, including interference that may cause undesired operation.

Do not make any changes or modifications to the equipment unless otherwise specified in the instructions. If such changes or modifications should be made, you could be required to stop operation of the equipment.

This equipment has been tested and found to comply with the limits for a class B digital device, pursuant to part 15 of the FCC Rules. These limits are designed to provide reasonable protection against harmful interference in a residential installation. This equipment generates, uses and can radiate radio frequency energy and, if not installed and used in accordance with the instructions, may cause harmful interference to radio communications.

However, there is no guarantee that interference will not occur in a particular installation. If this equipment does cause harmful interference to radio or television reception, which can be determined by turning the equipment off and on, the user is encouraged to try to correct the interference by one or more of the following measures:

- Reorient or relocate the receiving antenna.
- Increase the separation between the equipment and receiver.
- Connect the equipment into an outlet on a circuit different from that to which the receiver is connected.
- Consult the dealer or an experienced radio/TV technician for help.

CAN ICES-3 (B) / NMB-3 (B)

Nomenclature

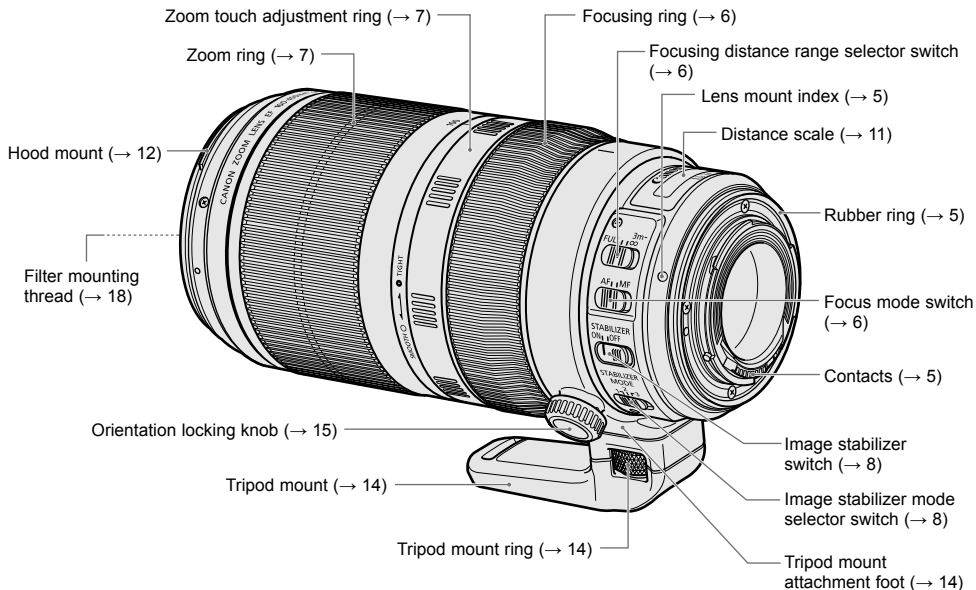

● For detailed information, reference page numbers are provided in parentheses (→ **).

1. Mounting and Detaching the Lens

See your camera's instructions for details on mounting and detaching the lens.

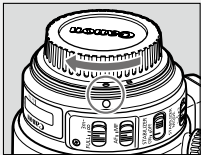
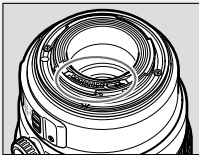

- After detaching the lens, place the lens with the rear end up to prevent the lens surface and contacts from getting scratched.
- If the contacts get soiled, scratched, or have fingerprints on them, corrosion or faulty connections can result. The camera and lens may not operate properly.
- If the contacts get soiled or have fingerprints on them, clean them with a soft cloth.
- If you remove the lens, cover it with the dust cap. To attach it properly, align the lens mount index and the  index of the dust cap as shown in the diagram, and turn clockwise. To remove it, reverse the order.



The lens mount has a rubber ring for enhanced dust- and water-resistance. The rubber ring may cause slight abrasions around the camera's lens mount, but this will not cause any problems. If the rubber ring becomes worn, it is replaceable by a Canon Service Center at cost.

2. Setting the Focus Mode

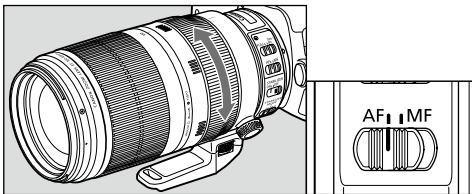

To shoot in autofocus (AF) mode, set the focus mode switch to AF.

To shoot in manual focus (MF) mode, set the focus mode switch to MF, and focus by turning the focusing ring. The focusing ring always works, regardless of the focus mode.

 After autofocus in ONE SHOT AF mode, focus manually by pressing the shutter button halfway and turning the focusing ring. (Full-time manual focus)

3. Switching the Focusing Distance Range

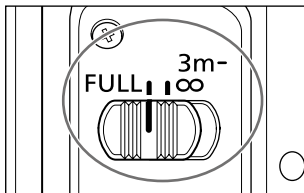

You can set the focusing distance range with a switch. By setting a suitable focusing distance range, the actual autofocus time will be shorter.

Ranges

1. FULL (0.98 m/3.22 ft. - ∞)
2. 3 m/9.84 ft. - ∞

4. Zooming and Adjusting Zooming Resistance

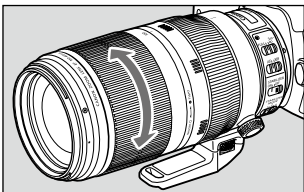

To zoom, rotate the zoom ring.

- Be sure to finish zooming before focusing. Zooming after focusing can affect the focus. Especially for shooting distances shorter than 3 m / 9.8 ft., zooming to another focal length will greatly change the focus.
- To prevent unintended zooming when not shooting, we recommend turning the adjustment ring towards the word TIGHT until it stops.

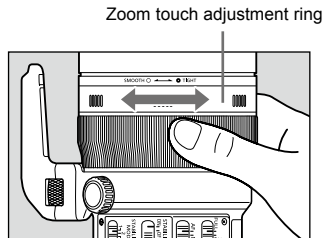

The operational feel (tightness) of the zoom ring can be adjusted as desired. Turn the adjustment ring towards the word SMOOTH to reduce the zooming touch, or towards TIGHT to increase it.

5. Image Stabilizer

You can use the image stabilizer in AF or MF mode.

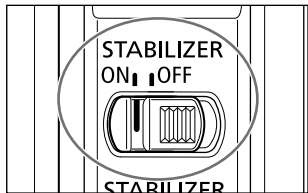

1 Set the STABILIZER switch to ON.

- If you are not going to use the image stabilizer function, set the switch to OFF.

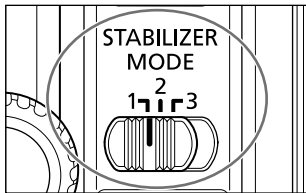

2 Select the stabilizer mode.

- MODE 1: Corrects vibrations in all directions. It is mainly effective for shooting still subjects.
- MODE 2: Corrects vertical camera shake during following shots in a horizontal direction, and corrects horizontal camera shake during following shots in a vertical direction.
- MODE 3: Corrects vibration only during exposure. During panning shots, corrects vibration during exposure only in one direction the same as MODE 2.

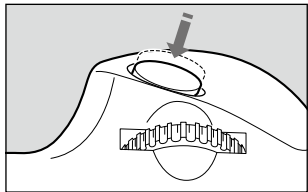

3 First press the shutter button down halfway, then press down all the way to take the picture.

- MODE 1, 2: Press the shutter button down halfway to stabilize the image in the viewfinder and enable stabilization.
- MODE 3: Press the shutter down halfway to initiate computation of stabilization, then press down all the way to enable stabilization.

6. Tips on Using the Image Stabilizer

The image stabilizer for this lens is effective for hand-held shots in the following conditions.

● MODE 1



- In semi-darkened areas such as indoors or outdoors at night.
- In locations where flash photography is prohibited, such as art museums and theater stages.
- In situations where your footing is uncertain.
- In situations where fast shutter settings cannot be used.

● MODE 2



- When panning subjects in motion.
- **MODE 3**
- Since camera shake is stabilized only during exposure, following a subject is easier such as when shooting a fast and irregularly moving player during sports photography.

Tips on Using the Image Stabilizer

- The Image Stabilizer cannot compensate for a blurred shot caused by a subject that moved.
- Set the STABILIZER switch to OFF when you are taking pictures using the Bulb setting (long exposures). If the STABILIZER switch is set to ON, the image stabilizer function may introduce errors.
- The Image Stabilizer might not be fully effective in the following cases:
 - You shoot from a violently moving vehicle.
 - You move the camera dramatically for a panning shot in Mode 1.
- The Image Stabilizer consumes more power than normal shooting, resulting in fewer shots and a shorter movie shooting time.
- The image stabilizer operates for about two seconds even when your finger is off the shutter button. Do not remove the lens while the stabilizer is in operation. This will cause a malfunction.
- With the EOS-1V/HS, 3, ELAN 7E/ELAN 7/30/33, ELAN 7NE/ELAN 7N/30V/33V, ELAN II/ELAN II E/50/50E, REBEL 2000/300, IX, IX Lite/IX7, and D30, the Image Stabilizer will not work during self-timer operation.



- Using a tripod also stabilizes the image. However, depending on the kind of tripod and shooting conditions, sometimes it may be better to turn off the Image Stabilizer function.
- The stabilizer is equally effective for hand-held photography and photography with a monopod. The Image Stabilizer effect may be reduced, however, depending on the shooting environment.
- Depending on the camera there may be image shake, such as after releasing the shutter. However, this does not affect shooting.
- If you set the camera's Custom Function to change the assigned button to operate the AF, the Image Stabilizer will operate when you press the newly assigned AF button.

7. Infinity Compensation Mark

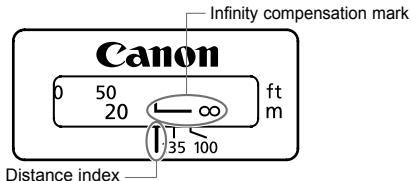

To compensate for shifting of the infinity focus point that results from changes in temperature, there is a margin at the infinity (∞) position. The infinity position at normal temperature is the point at which the vertical line of the distance scale L mark is aligned with the distance index.

- For accurate focusing in MF on subjects at infinity distance, look through the viewfinder or at the camera's LCD display while rotating the focusing ring.

8. Infrared Index

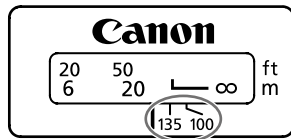

The infrared index corrects the focus setting when using monochrome infrared film. Focus on the subject manually, then adjust the distance setting by moving the focusing ring to the corresponding infrared index mark.

- Some EOS cameras cannot use infrared film. See the instructions for your EOS camera.

- The infrared index position is based on a wavelength of 800 nm.
- The compensation amount differs depending on the focal length. Use the indicated focal length as a guide when setting the compensation amount.
- Be sure to observe the manufacturer's instructions when using infrared film.
- Use a red filter when you take the picture.

9. Hood

The ET-83D hood cuts out unwanted light and protects the front of the lens from rain, snow, and dust.

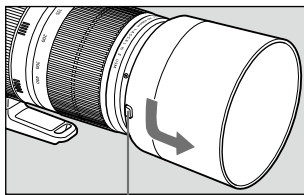
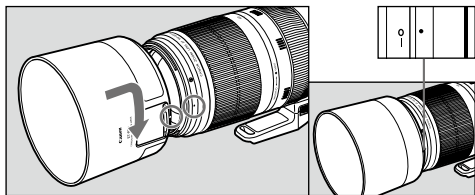

Button

● Attaching

To attach the hood, align the hood's attachment position mark with the red dot on the front of the lens, then turn the hood as shown by the arrow until the lens' red dot is aligned with the hood's stop position mark.

● Removing

To remove the hood, hold down the button on the side and turn the hood in the direction of the arrow until the position mark on the hood aligns with the red dot. The hood can be reverse-mounted on the lens for storage.

ⓘ ● If the hood is not attached properly, vignetting (darkening of the perimeter of the picture) may occur.

● When attaching or detaching the hood, grasp the base of the hood to turn it. To prevent deformation, do not grasp the rim of the hood to turn it.

● Circular Polarizing Filter Adjustment Window

The hood features a circular polarizing filter adjustment window which, when opened, allows the user to adjust the circular polarizing filter* while the hood is attached to the lens.

* Please attach the circular polarizing filter to the filter mounting thread on the front of the lens when the hood is detached.

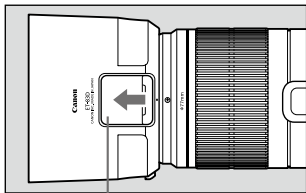

Circular polarizing filter adjustment window

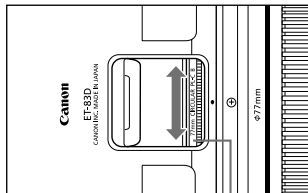

Circular polarizing filter

- 1 Open the circular polarizing filter adjustment window which is installed in the hood by sliding it forward.

- 2 Adjust the circular polarizing filter via the open adjustment window.

- Please close the circular polarizing filter adjustment window during shooting.



For information on attaching a circular polarizing filter, please refer to the section entitled “12. Filters” (p. 18).

10. Using the Tripod Mount

A tripod or monopod attaches to the tripod mount on the lens.

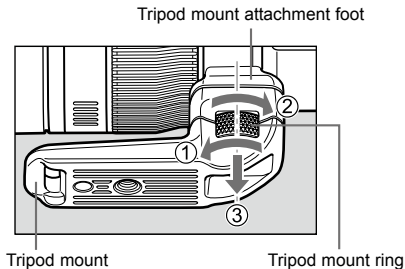

Attaching the Tripod Mount

- Place the tripod mount against the tripod mount attachment foot as shown and rotate the tripod mount ring in the direction indicated by arrow ② until it stops moving. Once the tripod mount ring stops moving, please attempt to firmly tighten it again.

Detaching the Tripod Mount

- Rotate the tripod mount ring in the direction indicated by arrow ① until the tripod mount has been detached.

 Pushing down on the tripod mount ring in the direction indicated by arrow ③ will make it easier to rotate.

Using the Tripod Mount

- An internal screw thread in the tripod mount attachment foot is exposed when the tripod mount is detached. Please do not attach a tripod or monopod to the lens using this internal screw thread. Doing so will damage the internal screw thread, making it impossible to attach the tripod mount to the lens.
- When attaching the tripod mount, firmly tighten the tripod mount ring so that the tripod mount is mounted securely to the lens. The lens may fall from the tripod mount if the lock knob is not fully tightened.
- Not attaching the tripod mount securely may result in out of focus images even when using a tripod or monopod during shooting.
- Please attach the tripod mount in the direction as shown in the illustration. It is not possible to attach the tripod mount while positioned in any other direction.
- The tripod mount ring will make a clicking sound while rotated which is normal.

Adjusting the Tripod Mount

By loosening the orientation locking knob, you can rotate the camera to set the image for any vertical or horizontal position.

11. Extenders (Sold Separately)

Lens specifications when using extender EF1.4x II/III or EF2x II/III are as follows.

		Extender EF1.4x II/III		Extender EF2x II/III	
		WIDE	TELE	WIDE	TELE
Focal length (mm)		140	560	200	800
Aperture		f/6.3-45	f/8-57	f/9-64	f/11-81
Angle of view	Diagonal	17° 35'	4° 25'	12° 00'	3° 05'
	Vertical	9° 50'	2° 25'	7° 00'	1°40'
	Horizontal	14° 40'	3° 40'	10° 00'	2°35'
Maximum magnification (x)		0.17	0.44	0.26	0.64

Extenders (Sold Separately)

- Attach the extender to the lens, and then attach the lens to the camera. To remove it, reverse the order. Errors may occur if you attach the extender to the camera first.
- When using this lens when shooting with EOS A2/A2E/5, use -0.5 step exposure compensation when using extender EF1.4x II, and use -1 step exposure when using extender EF2x II.
- Autofocusing (AF) is not possible when using Extender EF2x II/III. Therefore, please use manual focus (MF) for shooting when using this extender.
- Autofocusing (AF) is not possible when using Extender EF1.4x II/III. Therefore, please use manual focus (MF) for shooting when using this extender.
However, autofocus (AF) using only center AF points while shooting is possible when using the lens with the following camera models: EOS-1D X*, EOS-1Ds Mark III, EOS-1Ds Mark II, EOS-1Ds, EOS-1D Mark IV, EOS-1D Mark III, EOS-1D Mark II N, EOS-1D Mark II, EOS-1D, EOS 5D Mark III*, EOS 7D Mark II, EOS-1V/HS, and EOS 3
- Extenders cannot be used more than one at a time.

 When an extender is attached, the AF speed will become slower to retain proper control.

- * This camera will allow autofocus while shooting after updating the camera's firmware. Please check the Canon website for information about firmware updates.

12. Filters (sold separately)

You can attach filters to the filter mounting thread on the front of the lens.

-  If you need a polarizing filter, use the Canon Circular Polarizing Filter PL-C B (77 mm).
- The circular polarizing filter can be adjusted via the hood's adjustment window which is opened by sliding it forward.

13. Close-up Lenses (sold separately)

Attaching a 500D (77 mm) Close-up Lens enables close-up photography. It provides a magnification of 0.2x to 0.78x.

-  Close-up Lens 250D cannot be attached because there is no size that fits the lens.
- MF mode is recommended for accurate focusing.

14. Extension Tubes (Sold Separately)

You can attach extension tube EF12 II or EF25 II for magnified shots. The shooting distance and magnification are shown below.

		Focusing Distance Range (mm)		Magnification (×)	
		Close distance	Long distance	Close distance	Long distance
EF12 II	100mm	586	1121	0.27	0.12
	400mm	881	13306	0.38	0.03
EF25 II	100mm	476	664	0.42	0.27
	400mm	814	6571	0.46	0.07

-  MF mode is recommended for accurate focusing.

Specifications

Focal Length/Aperture	100-400mm f/4.5-5.6	
Lens Construction	16 groups, 21 elements	
Minimum Aperture	f/32-40*	
Angle of View	Diagonal	24°- 6° 10'
	Vertical	14°- 3° 30'
	Horizontal	20°- 5° 10'
Min. Focusing Distance	0.98 m/3.22 ft.	
Max. Magnification	0.31x (at 400 mm)	
Field of View	Approx. 77 x 116 mm/3.03 x 4.57 inch (at 0.98 m/3.22 ft.)	
Filter Diameter	77 mm	
Max. Diameter and Length	94 x 193 mm/3.70 x 7.60 inch	
Weight	Approx. 1570 g/55.4 oz	
Hood	ET-83D	
Lens Cap	E-77 II	
Case	LZ1326	

* Applies to 1/3-stop increments. With 1/2-stop increments, it will be f/32-38.

- The lens length is measured from the mount surface to the front end of the lens. Add approx. 24.2 mm when including the lens cap and dust cap.
- The size and weight listed are for the lens only (without the tripod mount attached).
- The Close-up Lenses 250D cannot be attached.
- Aperture settings are specified on the camera.
- All data listed is measured according to Canon standards.
- Product specifications and appearance are subject to change without notice.

Canon