

## AXIS P72 Video Encoder Series

Full-featured, cost-effective video encoders with H.264.

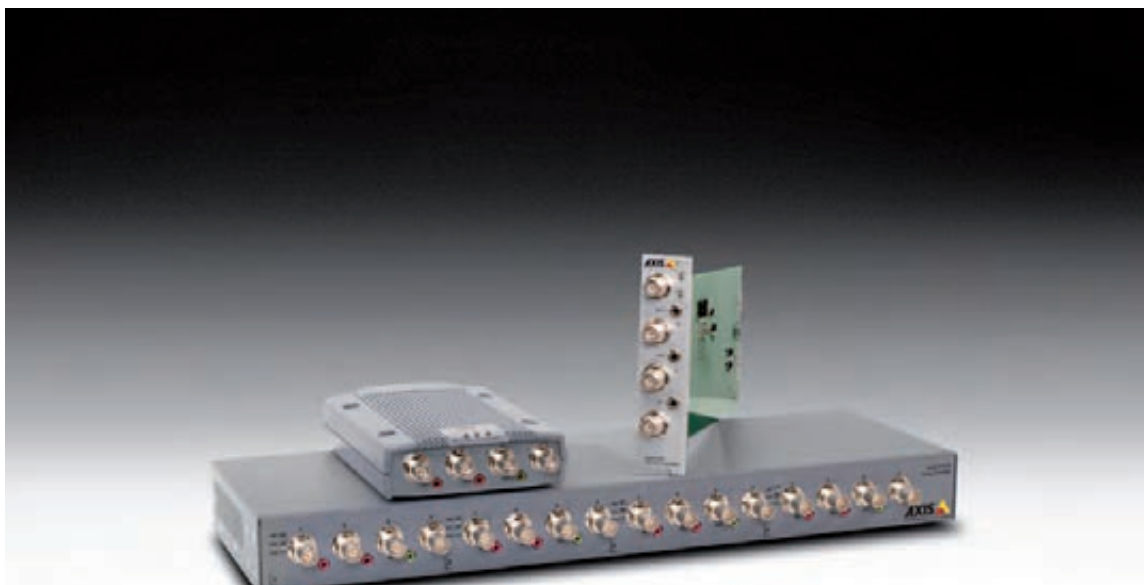

- > Full frame rate
- > Simultaneous H.264 and Motion JPEG streams
- > Edge storage
- > High resolution quad-view
- > Two-way audio
- > Power over Ethernet

AXIS P72 Video Encoder Series offers powerful, full-featured and efficient integration of analog cameras into an IP-based video surveillance system and is ideal for locations such as gas stations, convenience stores and small offices.

AXIS P72 Series enables a cost-effective way to gain all the benefits of professional network video without discarding existing analog investments. The video encoders offer advanced network capabilities with great video performance and excellent audio quality.

AXIS P72 Video Encoder Series comprises two 4-channel models and one 16-channel model providing H.264 and Motion JPEG streams. The support for H.264 offers a superb video compression format that drastically reduces bandwidth and storage requirements without compromising image quality.

All video encoders in AXIS P72 Series offer one H.264 and one Motion JPEG stream per channel at full frame rate in all resolutions up to D1 (720x480 NTSC or 720x576 PAL).

AXIS P72 Series offers intelligent video capabilities such as video motion detection, active tampering alarm and two-way audio with audio detection.

AXIS P72 Series includes support for Power over Ethernet (IEEE 802.3af), which enables the encoders to receive power through the network cable. All Axis video encoder products also provide pan, tilt and zoom support, enabling control of analog PTZ cameras. The standalone versions also have microSDHC memory card slots for edge storage.



## Technical specifications – AXIS P7214/P7210 Video Encoders

Video encoder		System integration	
<b>Models</b>	<b>AXIS P7214:</b> 4-channel video encoder <b>AXIS P7210:</b> 16-channel video encoder	<b>Application Programming Interface</b>	Open API for software integration, including VAPIX® from Axis Communications, available at <a href="http://www.axis.com">www.axis.com</a> ONVIF, specification available at <a href="http://www.onvif.org">www.onvif.org</a>
<b>Video compression</b>	H.264 (MPEG-4 Part 10/AVC) Baseline and Main Profile Motion JPEG	<b>Intelligent video</b>	Video motion detection, active tampering alarm, audio detection
<b>Resolutions</b>	176x120 to 720x576, 176x120 to 1536x1152 for quad view	<b>Alarm triggers</b>	Intelligent video, external inputs, video loss
<b>Frame rate H.264</b>	30/25 (NTSC/PAL) fps 15 fps in quad view in full resolution	<b>Alarm actions</b>	File upload via FTP, HTTP and email; notification via email, HTTP and TCP; external output activation; video and audio recording to edge storage; pre- and post-alarm video buffering, PTZ preset, play audio clip
<b>Frame rate Motion JPEG</b>	30/25 (NTSC/PAL) fps 15 fps in quad view in full resolution	<b>Pan/Tilt/Zoom</b>	Wide range of analog PTZ cameras supported (drivers available for download at <a href="http://www.axis.com">www.axis.com</a> ) <b>AXIS P7214:</b> Support for one PTZ driver <b>AXIS P7210:</b> Support for one PTZ driver in each group of 4 channels 100 presets/camera, guard tour, PTZ control queue Supports Windows compatible joysticks
<b>Video streaming</b>	One individually configured H.264 and one Motion JPEG stream per channel at full frame rate. More streams if identical or limited in frame rate/resolution Controllable frame rate and bandwidth VBR/CBR H.264	<b>General</b>	
<b>Image settings</b>	Compression, color, brightness, contrast Rotation: 90°, 180°, 270° Aspect ratio correction, mirroring of images, text and image overlay, privacy mask, enhanced deinterlace filter, video termination, antialiasing, temporal noise filtering	<b>Casing</b>	<b>AXIS P7214, P7210:</b> Standalone, metal casing <b>AXIS P7214:</b> Wallmount <b>AXIS P7210:</b> Rackmount or wallmount
<b>Audio</b>		<b>Processor and memory</b>	<b>AXIS P7214:</b> ARTPEC-4, 512 MB RAM, 128 MB Flash <b>AXIS P7210:</b> Same as above x 4
<b>Audio streaming</b>	Two-way, full duplex and half duplex (mic/line input 1/line output). Two-way, full duplex and half duplex (mic/line input 2/line output)	<b>Power</b>	<b>AXIS P7214:</b> 8-20 V DC, max 8W; Power over Ethernet IEEE 802.3af Class 3 <b>AXIS P7210:</b> 8-20 V DC, max 32W; 4 x Power over Ethernet IEEE 802.3af Class 3
<b>Audio compression</b>	In: AAC-LC 8 or 16 kHz 8-64 kbit/s, G.711 μ-law PCM 8 kHz 64 kbit/s, G.726 ADPCM 8 kHz 32 kbit/s or 24 kbit/s Out: G.711 μ-law PCM 8 kHz 64 kbit/s, μ-law PCM 16 kHz 128 kbit/s, G.726 ADPCM 8 kHz 32 kbit/s or 24 kbit/s	<b>Connectors</b>	<b>AXIS P7214, P7210:</b> DC input terminal block <b>AXIS P7214:</b> 4 x analog composite video BNC inputs RJ-45 10BASE-T/100BASE-TX PoE Terminal block for four configurable external inputs/outputs Terminal block for RS-485/422 (full duplex) 2 x 3.5mm jacks for microphone or line input (mono) 3.5mm jack for audio output (mono) <b>AXIS P7210:</b> Same as above x 4
<b>Audio input/output</b>	External microphone input or line input Line level output Audio streaming, record (AU) and play uploaded (WAV, AU) clips AU (G.711 μ-law 8-bit 8/16 kHz mono), WAV (PCM 16-bit 8/16 kHz mono)	<b>Edge storage</b>	MicroSD/microSDHC/microSDXC slot supporting memory card up to 64 GB (card not included) <b>AXIS P7214:</b> One card slot <b>AXIS P7210:</b> Four card slots Support for recording to network share (network-attached storage or file server)
<b>Network</b>		<b>Operating conditions</b>	0 °C – 50 °C (32 °F – 122 °F) Humidity 20 – 80% RH (non-condensing)
<b>Security</b>	Password protection, IP address filtering, HTTPS* encryption, IEEE 802.1X* network access control, digest authentication, user access log	<b>Approvals</b>	EN 55022 Class B, EN 61000-3-2, EN 61000-3-3, EN 55024, EN 61000-6-1, EN 61000-6-2, EN 60950-1, C-tick AS/NZS CISPR 22, FCC Part 15 Subpart B Class B, ICES-003 Class B, VCCI Class B, KCC Class B, UL/IEC/EN 60950-1
<b>Supported protocols</b>	IPv4/v6, HTTP, HTTPS*, IEEE 802.1X*, QoS layer 3 DiffServ, FTP, SMTP, Bonjour, UPnP, SNMPv1/v2c/v3(MIB-II), DNS, DynDNS, NTP, RTSP, RTP, TCP, UDP, IGMP, RTCP, ICMP, DHCP, ARP, SOCKS	<b>Weight</b>	<b>AXIS P7214:</b> 570 g (1.26 lb.) <b>AXIS P7210:</b> 2540 g (5.6 lb.)
		<b>Included accessories</b>	Power supply, mounting and connector kits, Installation Guide, CD with installation and management tools, software and User's Manual, Windows decoder user licenses

\* This product includes software developed by the OpenSSL Project for use in the OpenSSL Toolkit. ([www.openssl.org](http://www.openssl.org))

More information is available at [www.axis.com](http://www.axis.com)

### Optional accessories

AXIS T8310 Video Surveillance Control Board



AXIS T91A02 Din Rail Clip 86mm (AXIS P7214 only)



For information on AXIS Camera Station and video management software from Axis' Application Development Partners, see [www.axis.com/products/video/software/](http://www.axis.com/products/video/software/)

## Technical specifications – AXIS P7224 Video Encoder Blade

Video encoder		System integration	
<b>Models</b>	AXIS P7224: 4-channel video encoder blade	<b>Application Programming Interface</b>	Open API for software integration, including VAPIX® from Axis Communications, available at <a href="http://www.axis.com">www.axis.com</a> ONVIF, specification available at <a href="http://www.onvif.org">www.onvif.org</a>
<b>Video compression</b>	H.264 (MPEG-4 Part 10/AVC) Baseline and Main Profile Motion JPEG	<b>Intelligent video</b>	Video motion detection, active tampering alarm, audio detection
<b>Resolutions</b>	176x120 to 720x576, 176x120 to 1536x1152 for quad view	<b>Alarm triggers</b>	Intelligent video, external inputs, video loss
<b>Frame rate H.264</b>	30/25 (NTSC/PAL) fps 15 fps in quad view in full resolution	<b>Alarm actions</b>	File upload via FTP, HTTP and email; notification via email, HTTP and TCP; external output activation; video and audio recording to edge storage; pre- and post-alarm video buffering, PTZ preset, play audio clip
<b>Frame rate Motion JPEG</b>	30/25 (NTSC/PAL) fps 15 fps in quad view in full resolution	<b>Pan/Tilt/Zoom</b>	Wide range of analog PTZ cameras supported (drivers available for download at <a href="http://www.axis.com">www.axis.com</a> ) Support for one PTZ driver 100 presets/camera, guard tour, PTZ control queue Supports Windows compatible joysticks
<b>Video streaming</b>	One individually configured H.264 and one Motion JPEG stream per channel at full frame rate. More streams if identical or limited in frame rate/resolution Controllable frame rate and bandwidth VBR/CBR H.264	<b>General</b>	
<b>Image settings</b>	Compression, color, brightness, contrast Rotation: 90°, 180°, 270° Aspect ratio correction, mirroring of images, text and image overlay, privacy mask, enhanced deinterlace filter, video termination, antialiasing, temporal noise filtering	<b>Casing</b>	Compatible with AXIS 291 1U Video Server Rack or the AXIS Q7900 Rack
<b>Audio</b>		<b>Processor and memory</b>	ARTPEC-4, 512 MB RAM, 128 MB Flash
<b>Audio streaming</b>	Two-way, full duplex and half duplex (mic/line input 1/line output). Two-way, full duplex and half duplex (mic/line input 2/line output)	<b>Power</b>	12 V DC, max 6 W
<b>Audio compression</b>	In: AAC-LC 8 or 16 kHz 8-64 kbit/s, G.711 μ-law PCM 8 kHz 64 kbit/s, G.726 ADPCM 8 kHz 32 kbit/s or 24 kbit/s Out: G.711 μ-law PCM 8 kHz 64 kbit/s, μ-law PCM 16 kHz 128 kbit/s, G.726 ADPCM 8 kHz 32 kbit/s or 24 kbit/s	<b>Connectors</b>	4x analog composite video BNC inputs 1x Terminal block for four configurable external inputs/outputs (on back of rack) 1x Terminal blocks for RS-485/422 (half duplex, on back of rack) 2x 3.5 mm jacks for microphone or line input (mono) 1x 3.5 mm jack for audio output (mono)
<b>Audio input/output</b>	External microphone input or line input Line level output Audio streaming, record (AU) and play uploaded (WAV, AU) clips AU (G.711 μ-law 8-bit 8/16 kHz mono), WAV (PCM 16-bit 8/16 kHz mono)	<b>Operating conditions</b>	0 °C - 45 °C (32 °F - 113 °F) Humidity 20-80% RH (non-condensing)
<b>Network</b>		<b>Approvals</b>	EN 55022, EN 61000-3-2, EN 61000-3-3, EN 55024, EN61000-6-1, EN61000-6-2, EN 60950-1, C-tick AS/NZS CISPR 22, FCC Part 15 Subpart B Class B, ICES-003 Class B, VCCI Class B, KCC Class A, UL/IEC/EN 60950-1 EN 55022 Class A for the Q7900 rack and Class B for the 291 1U rack
<b>Security</b>	Password protection, IP address filtering, HTTPS* encryption, IEEE 802.1X* network access control, digest authentication, user access log	<b>Weight</b>	210 g (0.46 lbs)
<b>Supported protocols</b>	IPv4/v6, HTTP, HTTPS*, IEEE 802.1X*, QoS layer 3 DiffServ, FTP, SMTP, Bonjour, UPnP, SNMPv1/v2c/v3(MIB-II), DNS, DynDNS, NTP, RTSP, RTP, TCP, UDP, IGMP, RTCP, ICMP, DHCP, ARP, SOCKS	<b>Included accessories</b>	Installation Guide, CD with installation and management tools, software and Users Manual, Windows decoder user licenses

\* This product includes software developed by the OpenSSL Project for use in the OpenSSL Toolkit. ([www.openssl.org](http://www.openssl.org))

More information is available at [www.axis.com](http://www.axis.com)

### Required hardware

AXIS Q7900 Rack

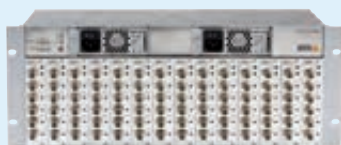

AXIS 291 1U Video Server Rack



### Optional accessories

AXIS T8310 Video Surveillance Control Board

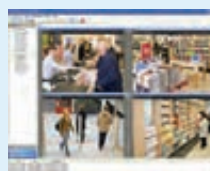

For information on AXIS Camera Station and video management software from Axis' Application Development Partners, see [www.axis.com/products/video/software/](http://www.axis.com/products/video/software/)

### Dimensions: AXIS P7214 Video Encoder

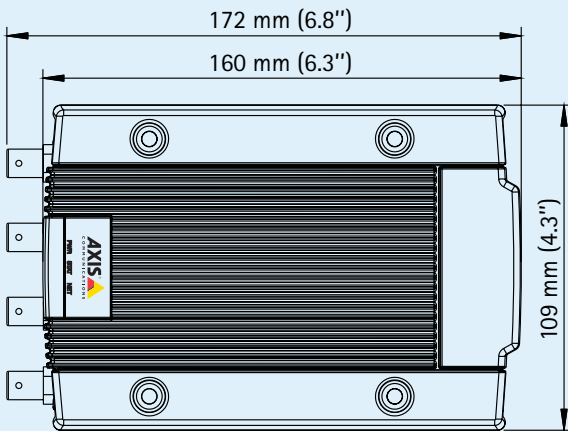

Back view

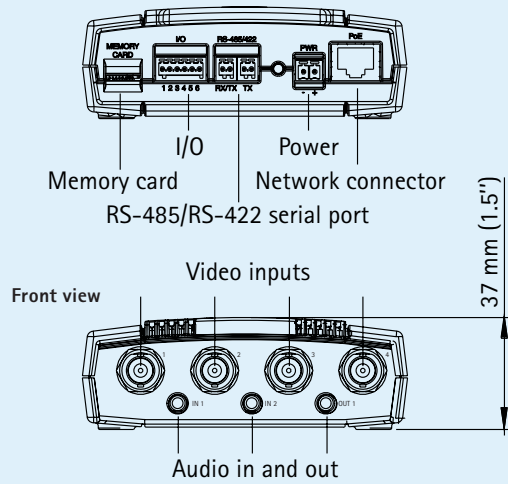

### Dimensions: AXIS P7210 Video Encoder

Front view

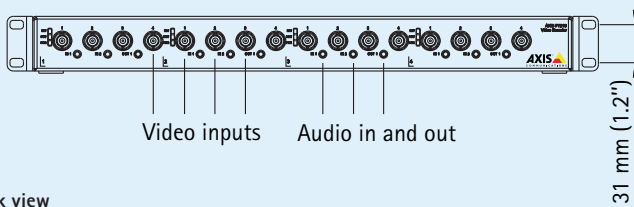

Back view

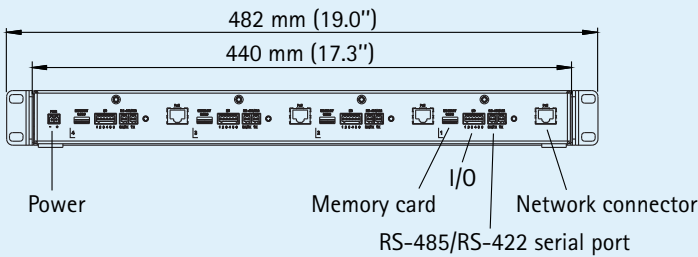

Profile view

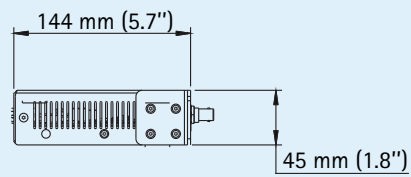

### Dimensions: AXIS P7224 Video Encoder Blade

