

AXIS F Series

Flexible cameras that let you see more



- > Flexible, rugged, discreet design
- > 1-channel
AXIS F41 with Wide Dynamic Range – Forensic Capture
- > 4-channel
AXIS F44 for multi-view surveillance
- > Choice of standard, varifocal, pinhole and fisheye lenses
- > Two-way audio

AXIS F Series offers flexible, high-performance 1080p cameras for extremely discreet indoor, outdoor and mobile surveillance applications. They are ideal for ATMs (automated teller machines), banks, stores, hotels, as well as rugged environments such as emergency vehicles, buses and trams.

Based on a divided network camera concept, AXIS F Series comprises AXIS F41 and AXIS F44 Main Units and AXIS F Sensor Units.

AXIS F41 connects to one sensor unit and supports Wide Dynamic Range – Forensic Capture and one memory card slot. It can provide HDTV 1080p video at up to 50/60 frames per second for capturing fast-moving objects and generating smoother video. AXIS F44 supports four sensor units, quad view and two memory card slots. The main units house the processor, network, power and other connections.

The four available sensor units are the standard AXIS F1005-E and the fisheye AXIS F1035-E, both for

indoor/outdoor use, and the varifocal AXIS F1015 and pinhole AXIS F1025 for indoor use. An AXIS F Sensor Unit consists of a lens and image sensor with a 3-m (10-ft.) or 12-m (39-ft.) cable. The divided concept enables the small sensor unit to be installed discreetly. The long cable from the sensor unit provides the flexibility to place the main unit where there is space for it.

Both AXIS F41 and AXIS F44 support two-way audio, RS232 for integration of external data to the video, four input/output ports for connection to external equipment, and intelligent video applications. They can be powered by Power over Ethernet or an 8–28 V DC power supply.



Flexible HDTV cameras for discreet indoor/outdoor surveillance



AXIS F products are ideal for installation in limited spaces and in highly discreet applications. The small sensor units are easy to install behind walls, ceilings, metal sheets and in doorways. Furthermore, AXIS F41/F44 Main Units and AXIS F1005-E/F1035-E Sensor Units can be used in vehicles for mobile surveillance since they can withstand tough conditions such as vibrations, shocks and temperature fluctuations. The IP66- and NEMA 4X-rated AXIS F1005-E/F1035-E can also be installed outdoors as they withstand dust, rain, snow and ice.

AXIS F41 with WDR for challenging lighting conditions

Scenes with very bright and dark areas are problematic for standard cameras. For example, in backlight situations where the camera faces a bright background, such as at entrances or in front of ATMs, a typical camera would produce an image where objects in the foreground or dark areas would hardly be visible. AXIS F41 Main Unit's support for Wide Dynamic

Range (WDR) – Forensic Capture enables a high level of detail to be visible in both the bright and dark areas of a scene. AXIS F Main Units, together with AXIS F Sensor Units' high light sensitivity, provide good color video in nighttime conditions.



The images above are from AXIS F41 with WDR – Forensic Capture, where details are visible in both the bright and dark areas. The image at left is taken with pinhole AXIS F1025 in a scene with strong backlight. The image at right is taken with fisheye AXIS F1035-E in a scene with high-contrast lighting.

AXIS F44 provides cost-effective coverage of four areas

AXIS F44 Main Unit connects to four sensor units, which can be placed in different areas up to 12 m away from the main unit. AXIS F44 enables

four separate 1080p or HDTV 720p streams to be sent simultaneously. It also supports one stream in quad view.

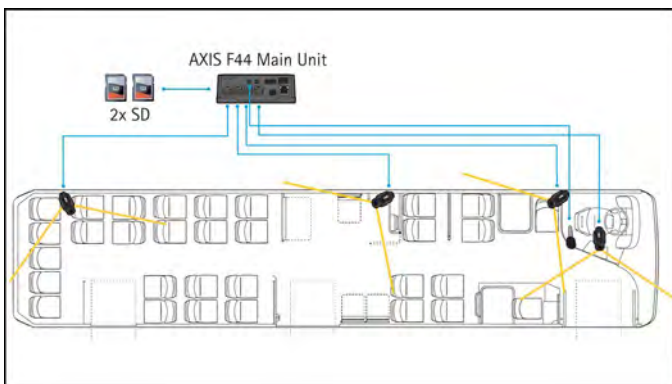

At left, an illustration with AXIS F44 (and local storage on SD cards), AXIS F1005-Es and a microphone in a bus. At right, quad view from a bus.

Technical Specifications - AXIS F Main Units

Models	AXIS F41: 1 channel, HDTV 1080p, WDR – Forensic Capture AXIS F44: 4 channels, 1080p/HDTV 720p, quad view (Main and sensor units sold separately)	Built-in installation aids	Pixel counter
Video		Data streaming	Event data
Video compression	H.264 (MPEG-4 Part 10/AVC) Baseline, Main and High Profiles Motion JPEG	General	
Resolutions	1920x1080 (1080p) to 160x90 AXIS F41: 1920x1200 (WUXGA)	Casing	Aluminum
Frame rate	AXIS F41: H.264/Motion JPEG: In 1080p (no WDR), 50/60 fps (50/60 Hz); In WUXGA (no WDR) and in 1080p with WDR, 25/30 fps (50/60 Hz) AXIS F44: H.264/Motion JPEG: In 1080p, 12.5/15 fps (50/60 Hz); In 720p, 25/30 fps (50/60 Hz)	Memory	AXIS F41: 512 MB RAM, 256 MB Flash AXIS F44: 1024 MB RAM, 256 MB Flash
Video streaming	Multiple, individually configurable streams in H.264 (Main, Baseline and High Profiles) and Motion JPEG; Controllable frame rate and bandwidth; VBR/MBR H.264 AXIS F44: quad view, max. 1080p resolution; 25/30 fps (50/60 Hz) with 720p capture mode; 12.5/15 fps (50/60 Hz) with 1080p capture mode	Power	AXIS F41: Power over Ethernet (PoE) IEEE 802.3af/802.3at Type 1 Class 3 (max 7.7 W); 8–28 V DC max 7.8 W AXIS F44: PoE IEEE 802.3af/802.3at Type 1 Class 3 (max 12.95 W); 8–28 V DC max 13.33 W
Image settings	Compression, Color, Brightness, Sharpness, Contrast, White balance, Exposure value, Exposure control, Exposure zones, Local contrast, Rotation, Corridor Format, Text and image overlay, Privacy mask, Mirroring of images AXIS F41: Wide Dynamic Range – Forensic Capture: up to 120 dB depending on scene	Connectors	Female RJ45 for 10BASE-T/100BASE-TX PoE; RJ12 for the sensor units; 6-pin terminal block for four configurable inputs/outputs (12 V DC output), max. load 50 mA; 3.5 mm mic/line in, 3.5 mm line out; 5-pin terminal block RS232; 2-pin terminal block for 8–28 V DC input
Audio		Edge storage	Support for recording to dedicated network-attached storage AXIS F41: One SD/SDHC/SDXC slot supporting memory card up to 64 GB (card not included) AXIS F44: Two SD/SDHC/SDXC slots supporting memory card up to 64 GB (card not included)
Audio streaming	Two-way	Operating conditions	-30 °C to 60 °C (-22 °F to 140 °F) Humidity 10–85% RH (non-condensing)
Audio compression	AAC-LC 8/16 kHz, 8–64 kbit/s; G.711 PCM 8 kHz 64 kbit/s; G.726 ADPCM 8 kHz 32 kbit/s or 24 kbit/s; Configurable bit rate AXIS F41: AAC-LC 8/16/32 kHz, 8–128 kbit/s	Approvals	ECE R10 rev.04, EN 50121-4, EN 50155 (vibration, shock, bump), EN 50581, IEC/EN/UL 60950-1, IEC 60068-2-1, IEC 60068-2-2, IEC 60068-2-14, IEC 60068-2-30, IEC 60068-2-60, IEC 60068-2-78, IEC 60529 IP4X, IEC 60721-3-5 5M3 (vibration, shock), IEC 62236-4, EN 55024, EN 61000-3-2, EN 61000-3-3, EN 61000-6-1, EN 61000-6-2 AXIS F41: EN 55022 Class B, FCC Part 15 Subpart B Class B, ICES-003 Class B, VCCI Class B, C-tick AS/NZS CISPR 22 Class B, KCC KN22 Class B, KN24 AXIS F44: EN 55022 Class A, FCC Part 15 Subpart B Class A, ICES-003 Class A, VCCI Class A, C-tick AS/NZS CISPR 22 Class A, KCC KN22 Class A, KN24
Audio input/output	External microphone input or line input, Line output	Dimensions	51 x 121 x 121 mm (2 x 4.8 x 4.8 in)
Network		Weight	AXIS F41: 532 g (1.17 lb); AXIS F44: 542 g (1.19 lb)
Security	Password protection, IP address filtering, HTTPS ^a encryption, IEEE 802.1X ^a network access control, Digest authentication, User access log, Centralized certificate management	Included accessories	Installation Guide, Installation and Management Software CD, Windows decoder 1-user license, AVHS Authentication key
Supported protocols	IPv4/v6, HTTP, HTTPS ^a , SSL/TLS ^a , QoS Layer 3 DiffServ, FTP, CIFS/SMB, SMTP, Bonjour, UPnP [™] , SNMPv1/v2c/v3 (MIB-II), DNS, DynDNS, NTP, RTSP, RTP, TCP, UDP, IGMP, RTCP, ICMP, DHCP, ARP, SOCKS, SSH	Optional accessories	AXIS F8001 Surface Mount with Strain Relief, AXIS F8002 DIN Rail Clip, AXIS T8120 15 W Midspan 1-port, AXIS T83 Microphones
System integration		Video management software	AXIS Camera Companion (included), AXIS Camera Station and video management software from Axis' Application Development Partners (not included)
Application Programming Interface	Open API for software integration, including VAPIX [®] and AXIS Camera Application Platform, specifications at www.axis.com; AXIS Video Hosting System (AVHS) with One-Click Camera Connection; ONVIF Profile S	Warranty	Axis 3-year warranty and AXIS Extended Warranty option, see www.axis.com/warranty
Intelligent video	Video motion detection, Active tampering alarm, Audio detection, AXIS Camera Application Platform		
Event triggers	Intelligent video, External inputs, Edge storage events		
Event actions	File upload: FTP, HTTP, network share and email; Notification: email, HTTP and TCP; External output activation; Pre- and post-alarm video buffering; Video and audio recording to edge storage; Play audio clip AXIS F41: WDR mode		

a. This product includes software developed by the OpenSSL Project for use in the OpenSSL Toolkit (<http://www.openssl.org/>), and cryptographic software written by Eric Young (ey@cryptsoft.com).

Dimensions – Main units

- SD card slot
- Camera connector
- Audio in and out
- I/O terminal connectors
- RS232
- Power connector
- Network connector

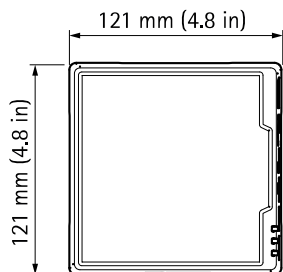

Ⓐ AXIS F41

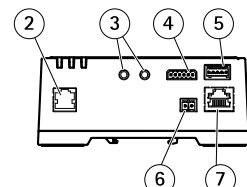
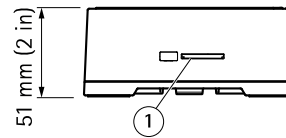

Ⓑ AXIS F44

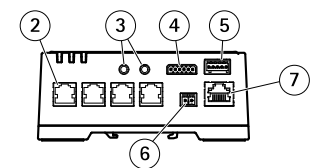
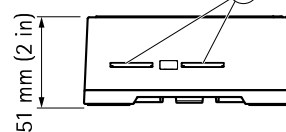

Technical Specifications - AXIS F Sensor Units

Models	Sensor units with option of 3-m or 12-m (10-ft or 39-ft) cable: AXIS F1005-E: Standard, IP66-rated AXIS F1015: Varifocal AXIS F1025: Pinhole AXIS F1035-E: Fisheye, IP66-rated (Main and sensor units sold separately)
Camera	
Image sensor	1/2.8" (effective) progressive scan RGB CMOS
Lens	Fixed iris AXIS F1005-E: 2.8 mm, F2.0: 113° view ^a with AXIS F41/F44; 73° view ^a with AXIS F44 in HDTV 720p AXIS F1015: 3–6 mm, F2.0: 108° to 53° view ^a with AXIS F41/F44; 65° to 35° view ^a with AXIS F44 in HDTV 720p AXIS F1025: 3.7 mm, F2.5: 92° view ^a with AXIS F41/F44; 56° view ^a with AXIS F44 in HDTV 720p AXIS F1035-E: 1.3 mm, F2.8: 194° view ^a with AXIS F41/F44; 112° view ^a with AXIS F44 in HDTV 720p
Minimum illumination	Color: 0.3 lux
Shutter time	AXIS F41: HDTV 1080p 25/30/50/60 fps: 1/143000 s to 2 s; WUXGA (1920x1200) 25/30 fps: 1/143000 s to 2 s AXIS F44: 1080p 12.5/15 fps: 1/22500 s to 2 s; HDTV 720p 25/30 fps: 1/28000 s to 2 s
General	
Casing	Aluminum
Operating conditions	-30 °C to 55 °C (-22 °F to 131 °F) AXIS F1005-E/F1035-E: Humidity 10–100% RH (condensing) AXIS F1015/F1025: Humidity 10–85% RH (non-condensing)

Approvals	ECE R10 rev.04, EN 50121-4, IEC/EN/UL 60950-1, IEC 60068-2-1, IEC 60068-2-2, IEC 60068-2-14, IEC 60068-2-30, IEC 60068-2-78, IEC 60529 IP4X, IEC 62236-4, EN 55022 Class B, EN 55024, EN 61000-3-2, EN 61000-3-3, EN 61000-6-1, EN 61000-6-2, FCC Part 15 Subpart B Class B, ICES-003 Class B, VCCI Class B, C-tick AS/NZS CISPR 22 Class B, KCC KN22 Class B, KN24, EN 50581 AXIS F1005-E/F1035-E: EN 50155 (vibration, shock, bump), IEC 60068-2-60, IEC 60529 IP66, IEC 60721-3-5 5M3 (vibration, shock), IEC/EN/UL 60950-22, NEMA 250 Type 4X AXIS F1015/F1025: IEC 60068-2-6, IEC 60068-2-27
Weight	AXIS F1005-E (12 m / 39 ft cable): 366 g (0.81 lb) AXIS F1005-E (3 m / 10 ft cable): 116 g (0.26 lb) AXIS F1015 (12 m / 39 ft cable): 370 g (0.82 lb) AXIS F1015 (3 m / 10 ft cable): 120 g (0.26 lb) AXIS F1025 (12 m / 39 ft cable): 328 g (0.72 lb) AXIS F1025 (3 m / 1 ft cable): 78 g (0.17 lb) AXIS F1035-E (12 m / 39 ft cable): 346 g (0.76 lb) AXIS F1035-E (3 m / 10 ft cable): 96 g (0.21 lb)
Included accessories	Installation Guide AXIS F1005-E/F1015/F1035-E: AXIS F8201 Vari-angle Mounting Bracket AXIS F1025: AXIS F8202 Straight Mounting Bracket
Optional accessories	AXIS F1005-E/F1015/F1035-E: AXIS F8203 Fixed Mount Bracket AXIS F1005-E: AXIS F8401 Clear Lens Protector
Warranty	Axis 3-year warranty and AXIS Extended Warranty option, see www.axis.com/warranty

a. Horizontal angle of view

More information is available at www.axis.com

Dimensions – Sensor units

1. AXIS F1005-E Sensor Unit
2. AXIS F1015 Sensor Unit
3. AXIS F1025 Sensor Unit
4. AXIS F1035-E Sensor Unit
5. Thread: M20 x 1.5

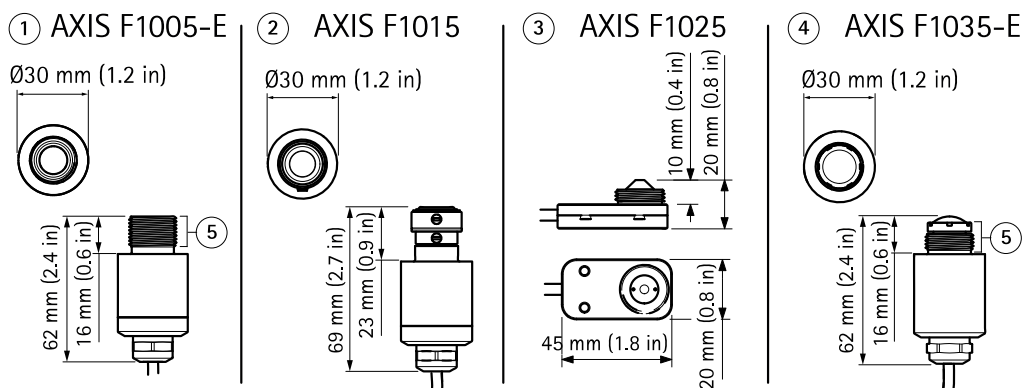

Included accessories – Mounting brackets

1. AXIS F8201 for
 AXIS F1005-E,
 AXIS F1015,
 AXIS F1035-E
2. AXIS F8202 for
 AXIS F1025



Optional accessories

1. AXIS F8203 Fixed
 Mount Bracket
 for AXIS F1005-E,
 AXIS F1015,
 AXIS F1035-E
2. AXIS F8401 Clear
 Lens Protector for
 AXIS F1005-E

