

Installation & User Manual For
Cell Switch *Prime*

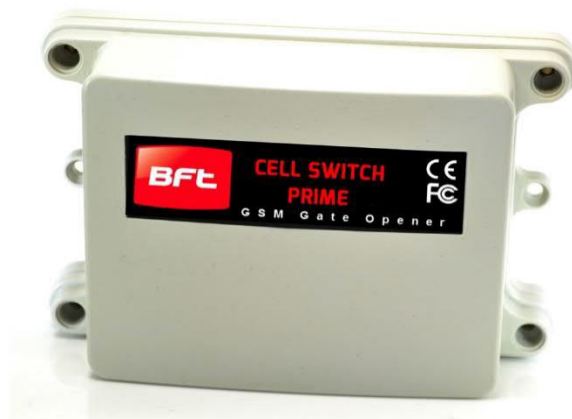

GSM Cellular Gate opener and GSM alarm signalling device.

BFT Americas

6100 Broken Sound Parkway N.W. Suite 14, Boca Raton, FL 33487



www.bft-usa.com

Toll Free: 877-995-8155

Office: 561-995-8155

Fax: 561-995-8160

Contents

| | |
|---|-------|
| Overview of system | Pg 3 |
| Site Survey | Pg 3 |
| SIM card | Pg 3 |
| Power | Pg 3 |
| Inserting the SIM card | Pg 4 |
| Connections on the GSM Controller | Pg 4 |
| Output Connections example | Pg 4 |
| Notification Feature | Pg 5 |
| Powering Up | Pg 5 |
| Programming | Pg 6 |
| Programming as an Access Control Device | Pg 6 |
| Internal Clock Function | Pg 7 |
| Winter / Summer Daylight Saving | Pg 7 |
| Set Automatic Triggering Times | Pg 7 |
| Delete all Automatic Triggering Times | Pg 8 |
| Notification Number | Pg 8 |
| Programming as an Alarm Dialling Device | Pg 8 |
| Complete List of Parameters | Pg 8 |
| Controlling Relays when used as Alarm | Pg 10 |
| Control by SMS | Pg 10 |
| Check Door / Gate Status | Pg 10 |
| Setting up the free App | Pg 10 |
| Using the Android App | Pg 12 |
| Using the Iphone App | Pg 15 |
| Troubleshooting | Pg 18 |
| Change History | Pg 19 |

Overview of System

Please read this entire manual before attempting to install this system.
This system should only be installed by a professional automatic gate installer or access control specialist dealer.
It is recommended that the system be set up, configured, commissioned and tested on a workshop bench **before** taken to site for installation.

Site Survey

Before installing this system, you need to be sure that there is good mobile GSM cell coverage in the area it is to be installed. It is recommended that you conduct a site survey, and check reception on the site for a GSM network. If reception is poor in the area, then this system is not recommended.

SIM Card

You will need a SIM card in order to use this system. It should be a regular voice and SMS text SIM card. Do not use a data only SIM, as this is only for tablets and will not work in the unit.

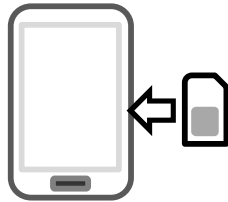

- 1) Ensure the SIM has calling credit, and can make and receive calls on a mobile cell phone.
- 2) Check that the SIM is not locked to a phone and can be used in other devices.
- 3) Check that the SIM does not have a PIN code request.
- 4) Disable voicemail service on the SIM.
- 4) You are now ready to begin programming.

Power

TIP: Most technical calls received are due to installers using CAT5 or alarm cable to power the unit. Neither are rated to carry enough power (2 amp peak). Please use following cable...

Up to 2 metres (6 feet) – Use minimum 0.5mm² (18 gauge)
Up to 4 metres (12 feet) – Use minimum 0.75mm² (16 gauge)
Up to 8 metres (24 feet) – Use minimum 1.0mm² (14 gauge)



WARNING

Warranty VOID if power cable requirements are not followed!

Using insufficient power cable thickness will cause excessive stress on electronic components, and therefore void the manufacturer's warranty.

To avoid such problems it is recommended (and is good practice) to locate the power supply as close to the device as possible. This avoids power cable noise and interference and enhances the lifetime of the product.

Inserting the SIM card

Note: This unit is a dual 2G/3G quad band system, operating on standard 2G network frequencies of 850/900/1800/1900MHz and 3G frequencies of 900/2100MHz.

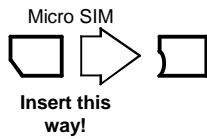

Do not use a SIM card for a tablet, as these only support data, and do not support voice and SMS. You simply require a cellular phone type SIM card.

- 1) Ensure the power is OFF
- 2) Slide the SIM card holder in the open direction, and carefully open the door. Do NOT force it.

Connections on the GSM Controller

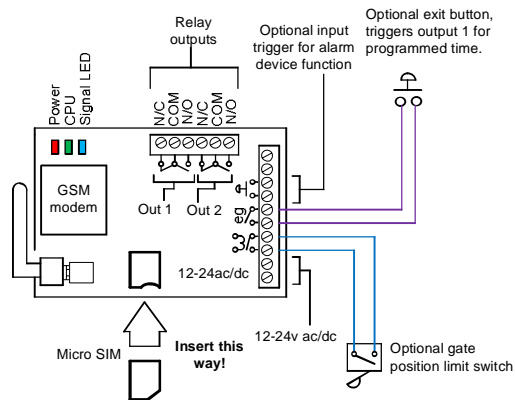

Output Connections Example

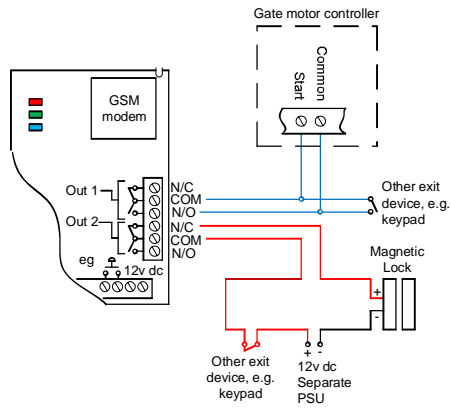

This example shows relay 2 connected to a gate motor controller for vehicle gates, and output 1 connected to a magnetic lock for a door or pedestrian gate.

Alternative Keypad Wiring for Notification Feature

The Cell Box Switch has an additional feature which sends an SMS to a master user when the GSM unit triggers its outputs. So if the user wants to know when an external device such as a keypad is triggered, then wire a keypad output to egress input of the GSM as shown...

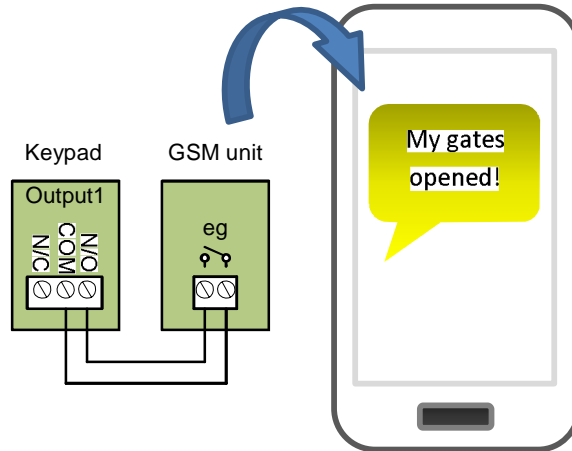

When the egress is triggered, the GSM unit's output 1 will be triggered and if the 78 feature is programmed, the unit will send an SMS.

Powering Up

Perform a final check of wiring, making sure that the power supply is no more than the absolute maximum is no more than 26v AC and ensure the antenna is connected before switching on the power. Once the power is switched on, the power LED should illuminate.

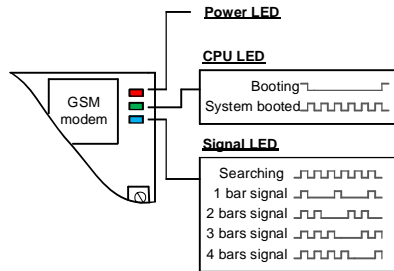

TIPS:

My GSM LED is still searching...

- Check the SIM card is registered and can make a call in a phone.
- Check the SIM card is seated correctly. Power off, clean the contacts on the SIM and the GSM unit, and reinsert the SIM.
- Check power cable distance and thickness.
- Increase antenna height.
- Change network.
- Move antenna away from metal objects or overhanging shrubs.
- Fit a high gain antenna.

Programming

TIP: The GSM unit programming is by sending SMS text messages to the unit from a phone.

Check Reception

Send the SMS ***20#** as shown, to the SIM card number of the intercom. The unit should reply with a reception level between 1 and 31.

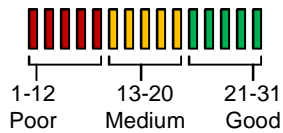

Note: Reception levels below 14 can give problems with the relay operation

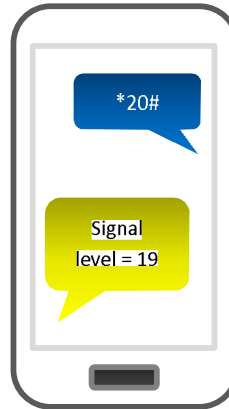

TIP: If reception levels are low, take action now! Either increase the height of the antenna to improve reception or request a higher gain antenna from your distributor or change to another network which may have better coverage.

Programming as a Gate / Door Access control Device

The unit is able to store up to 100 telephone numbers which can call the intercom and trigger the relay automatically with caller ID. Programming text messages must start with a pass code string, followed by a command, followed by data, and each command is separated in the SMS by #. Enter the phone numbers you require to have access in SMS strings as follows...

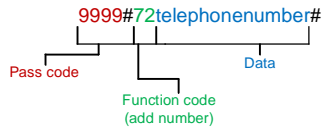

Tip: Up to 4 telephone numbers can be sent together in the same SMS message. Simply separate each with 72 as shown...

9999#72telephonenumber#72telephonenumber#
72telephonenumber#72telephonenumber#



Internal Clock (Function 86)

The PRIME model has many additional features which require the intercom to have the current time and day stored. Each time the intercom receives a SMS, it will use the time and date from the incoming message to re-calibrate its internal time clock. In the event of a power failure, the time will be lost, however the intercom can send a SMS to itself after rebooting. To activate this feature, enter the following code...

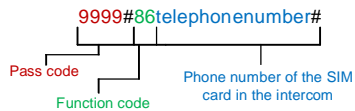

Note: Activating this feature will cause the unit to be busy for 2-3 minutes after boot up. Please be patient with the unit while it re-configures.

TIP: 9999#86*# will delete this number again

Winter/Summer Daylight Saving (Function 87)

For countries where there is a 1 hour time shift for daylight saving, It is useful to have the intercom check the time on a schedule. It will send an SMS to itself to check time every set number of days according to the function below..

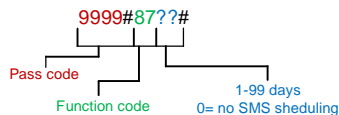

Note: Each time the intercom receives an SMS command of any type, it will re-sync time anyway, so this feature may not be necessary for users who use SMS to control the intercom regularly.

Set Automatic Triggering times

This feature is useful to automatically trigger electric gates at pre-set times of the day or night. For gates not set on "auto-closing", this can be used to have opened and closing times with momentary triggers. For gates on "auto-closing", this feature can be used with latching control, again to hold gates open during certain times.

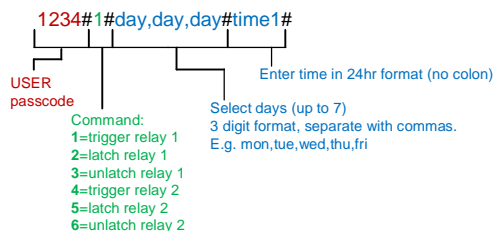

Example:

For gates on step-by-step operation, to automatically close every night at 10pm send SMS:

1234#1#sun,mon,tue,wed,thu,fri,sat#2200#

For gates on automatic closing, to hold open between 8am and 7pm, send SMS:

1234#2#sun,mon,tue,wed,thu,fri,sat#0800# and then a second SMS:

1234#3#sun,mon,tue,wed,thu,fri,sat#1900#

Note: Up to 40 events can be stored.

Delete ALL Automatic Triggering times

1234*#

Notification Number

This feature will send a SMS notification to a master user phone number every time the intercom is used to grant access. It will send a SMS any time a relay is activated.

To use this feature firstly turn the function on:

9999#802# (change 2 to 1 to disable again).

Now you must store the phone number which is to receive the notification:

9999#78number#

Now you may store a customised SMS content, which will be sent to the stored number:

9999#79enter any text here#

For example, you may wish to store the following message "My Gates Triggered", or "Gates Opened".

Programming as an Alarm Dialling Device

This advanced GSM unit is also able to be used as a GSM alarm device. If the input terminals are triggered with a closing connection, the device will call up to 4 phone numbers in sequence.

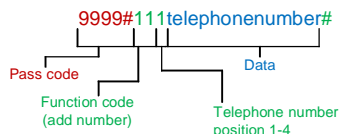

Tip: Up to 4 telephone numbers can be dialled in the event of an alarm. Simply change the number position digit as shown...

9999#111telephonenumber#112telephonenumber#113telephonenumber#114telephonenumber#

GSM unit complete list of parameters

The table below show the complete list of features in the cellular part of the intercom.

Programming messages below must begin with 9999# (assuming 9999 is still the programming passcode)...

Changing pass codes

| | | |
|---------|--|------|
| 01????# | Change programming password | 9999 |
| 02????# | Change access control password (SMS control of relays, or non-stored numbers can call intercom & enter code to activate output 1). | 1234 |

Dial out numbers

| | | |
|----------|--|-----|
| 1XY????# | Store dialling out numbers. (X = button number 1-9 & 0 for button 10) (Y = number dialled 1-4) (???? = phone number) | N/A |
| 1XY*# | Delete a dial out number. (X = button number) (Y = number position 1-4) | N/A |

Timings

| | | |
|------|---|---------|
| 50?# | Relay 1 time. ? = seconds, 1-9999 | 1 sec |
| 51?# | Relay 2 time. ? = seconds, 1-9999. | 1 sec |
| 45?# | Calling time for first number, adjust this to avoid voicemail picking up a call (10-99 secs) | 20 secs |
| 46?# | Calling time for second number, adjust this to avoid voicemail picking up a call (10-99 secs) | 20 secs |
| 47?# | Calling time for third number, adjust this to avoid voicemail picking up a call (10-99 secs) | 20 secs |
| | | |

Scheduled service calls

| | | |
|-----------|---|-----|
| 77number# | Store a service number to receive a scheduled call or SMS from the unit. Useful for SIM cards which are not often used to prevent switch off by the network provider. | N/A |
| 57?# | Set the time schedule for the intercom to make a scheduled call or SMS to the service number. 00-60 day time schedule. 00 = no call or SMS. | 00 |

| | | |
|------|---|-----|
| 58?# | Choose between making a scheduled call or scheduled SMS. 1 = SMS. 2 = call. | 1 |
| 77*# | Delete the stored service number | N/A |

Notification Number

| | | |
|-----------|---|-----|
| 78number# | Store a master user, who will receive a SMS notification from the intercom each time any of the output relays are triggered. | N/A |
| 79text# | Where "text" is the content of the message to be sent. E.g. "Gates Opened, or Door Opened". This will be sent on closing of any output relay. | N/A |
| 80?# | When ? = 1, this function is disabled. Set to 2 to enable. | N/A |

Caller ID features

| | | |
|-----------|---|-----|
| 72number# | Store caller ID number. Max 14 digits. Only last 6 digits compared. | N/A |
| 73number# | Delete caller ID number. | N/A |
| 73*# | Delete all caller ID numbers | N/A |

Service & diagnostic messages (no passcode required for these!)

| | | |
|------|---|-----|
| *20# | Check reception level 1-31 (no passcode needed) | N/A |
| *21# | Check stored numbers. O = dial out number. I = dial in number. E = end of message. (no passcode needed) | N/A |
| *22# | Check input status and relay status. (No passcode needed) | N/A |
| *23# | Call log of last 20 Caller ID numbers | N/A |

Restore Defaults

| | | |
|------|---|-----|
| 999# | Send with passcode string to clear all programming. | N/A |
|------|---|-----|

Controlling Relays when used as Alarm Dialler

If the alarm input is used to trigger the unit and call a phone, the user can answer the call and control the relays with DTMF touch tones on their phone as follows..

Relay 1

Press **1** to momentary trigger
 Press **2** to Latch or hold open
 Press **3** to unlatch or close.

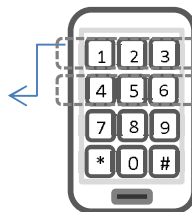

Relay 2

Press **4** to momentary trigger
 Press **5** to Latch or hold open
 Press **6** to unlatch or close

Control by SMS

This device allows the user to send SMS commands to control the relays as follows...

- | | |
|--|--|
| 1234#1# - Relay 1 momentary trigger. | 1234#4# - Relay 2 momentary trigger. |
| 1234#2# - Relay 1 latch ON or hold ON. | 1234#5# - Relay 2 latch ON or hold ON. |
| 1234#3# - Relay 1 unlatch or switch OFF. | 1234#6# - Relay 2 unlatch or switch OFF. |

Check if door or gate is open or closed



Send the SMS as shown, and the unit will reply showing the status of the input limit switch (if used), and the relay..

This example shows that the input sensor is in OPEN state. Relay 1 is OFF and Relay 2 is latched ON.

TIP: If there is not a physical limit switch fitted to the door or gate, then the status input will always show OPEN.

Setting up the Free App on Android & Iphone

Android and Iphone users can download an optional app called **BFT Cellbox PRIME**. This makes the procedure of triggering gates and creating automatic trigger times easy for the end user.

Android Setup

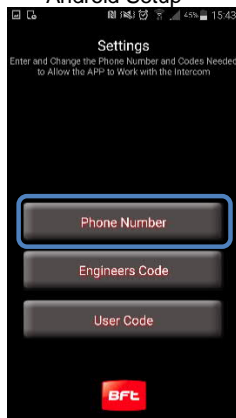
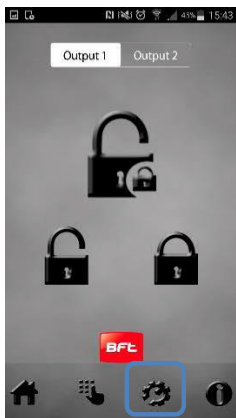

Apple Setup

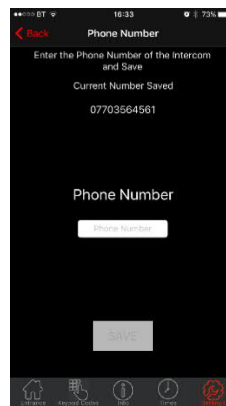
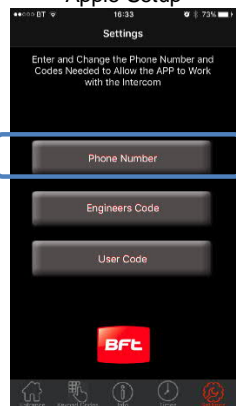
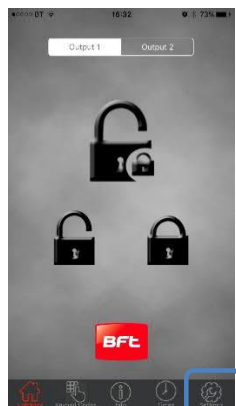

1. Install and launch the app. Press **SETTINGS** as shown.

2. Press the **PHONE NUMBER** button.

3. Enter the phone number of the intercom SIM card.

Note: If the default engineers code or user code have been changed from their defaults, then please change as required in the relevant section above.

IMPORTANT: On using the app, if you receive an error message stating “Command Failed”, go to **Settings/Application Manager/Permissions**, and turn on all permissions for the app.

Now you should be ready to use the app.

Using the App on Android

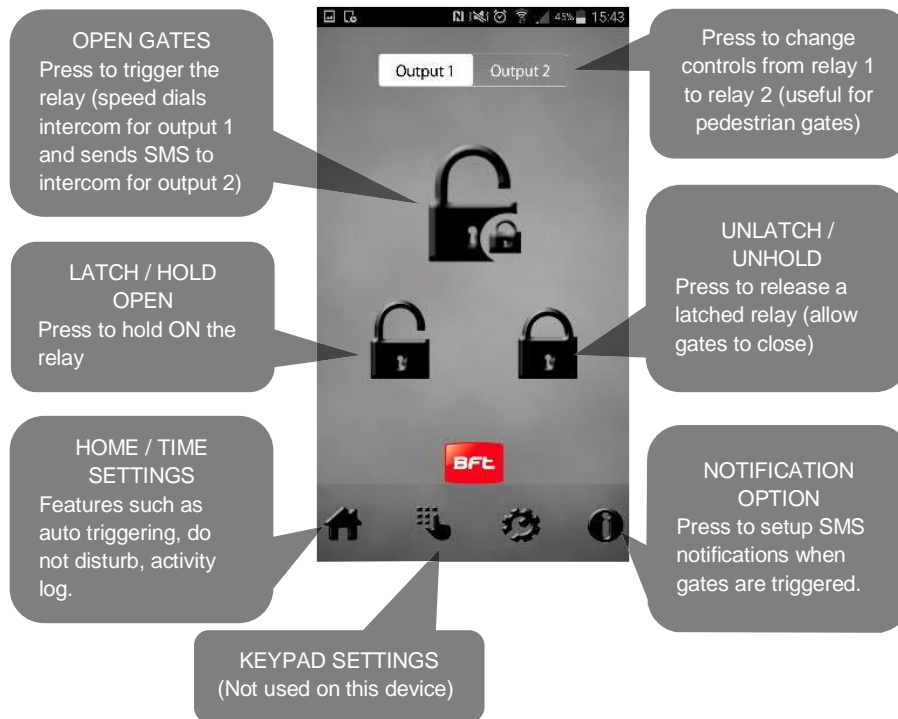

Automatic Triggering Times

Automatic Triggering Times
Set a Time For The Gates To Automatically Close
Enter Time in 24hr Format with No Spaces

Time 0000

Monday
 Tuesday
 Wednesday
 Thursday
 Friday
 Saturday
 Sunday

SAVE

Delete All Automatic Trigger Times
DELETE

BFT

This feature is for automatic gate systems which are not in automatic closing mode, and are in step-by-step mode. I.e. When triggered they open and stay open until triggered again. You can use this feature to automatically trigger gates to perhaps open every morning at a pre-set time, or close every night at a pre-set time.

TIP: Enter times in 24 hour format without any colon. E.g. 10pm should be entered as 2200, select the days and press SAVE.

Notification Feature

Notifications
Send a Text Message to a Phone to Notify
When the Intercom Has Allowed Access

ON OFF

Enter the Phone Number To Receive the SMS
and a Short Message i.e. Gates Opened

Phone Number
Message

SAVE

BFT

Can be used to send a SMS notification to a master user, each time someone calls the device and access is granted.

Toggle the feature on firstly. Then enter a phone number which will receive the notifications. Lastly enter a message like "Gates Opened"

Status Sub-Menu

The screenshot shows a mobile application interface for the 'Status' sub-menu. At the top, the title 'Status' is displayed, followed by a descriptive paragraph: 'Check The Signal Strength and Stored Numbers on the Intercom. Check if the Gate is Open or Closed. Check Who Gained Access and When.' Below this are four main menu items: 'Signal Strength', 'Stored Numbers', 'Gate Status', and 'Activity Log'. At the bottom center is the 'BFL' logo. Four callout boxes provide detailed instructions for each menu item.

Signal Strength
Check signal strength on your intercom. Level 1-31. Must be above 14 for successful operation.

Stored Numbers
Check stored numbers – Will send SMS reply with O for dial out numbers and I for dial in (caller ID access numbers).

Gate Status
Check the state of both relays (ON or OFF). ON = latched open state. Check status of gate limit switch (if fitted).

Activity Log
Check last 20 users who triggered gates, including date and time (date is international format (DD/MM/YYYY))

Using the app on Iphone

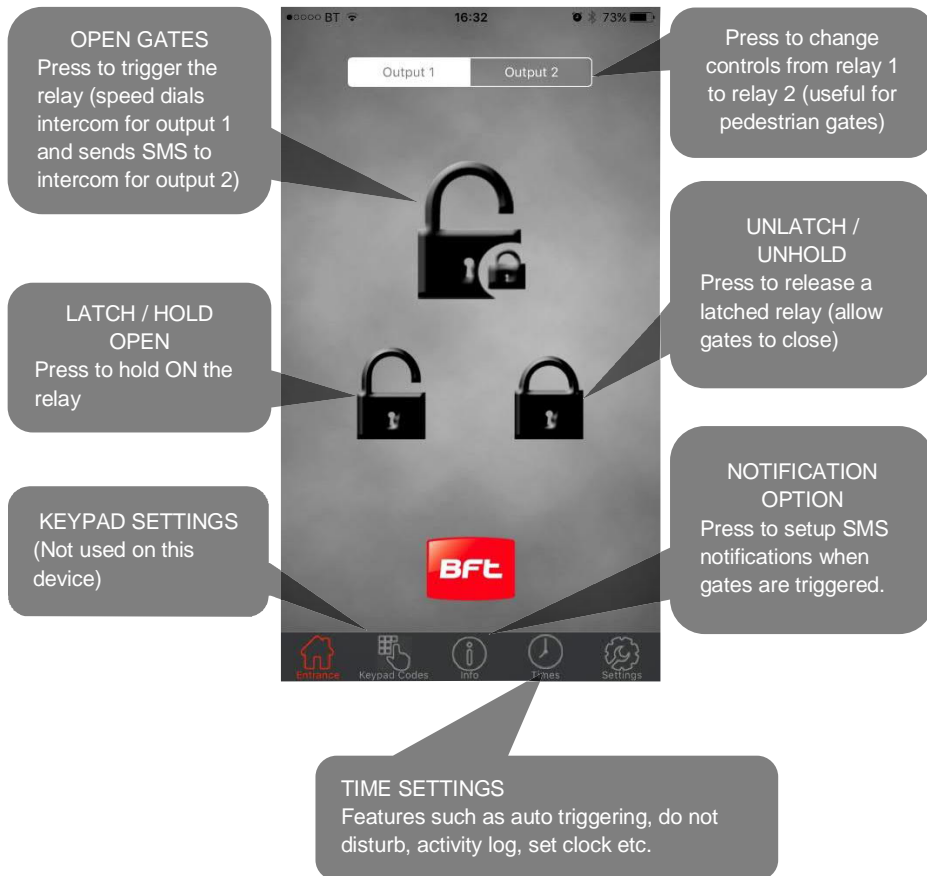

Automatic Triggering Times

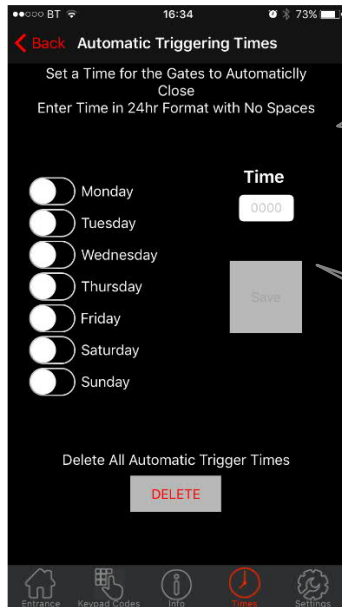

This feature is for automatic gate systems which are not in automatic closing mode, and are in step-by-step mode. I.e. When triggered they open and stay open until triggered again. You can use this feature to automatically trigger gates to perhaps open every morning at a pre-set time, or close every night at a pre-set time.

TIP: Enter times in 24 hour format without any colon. E.g. 10pm should be entered as 2200, select the days and press SAVE.

Notification Feature

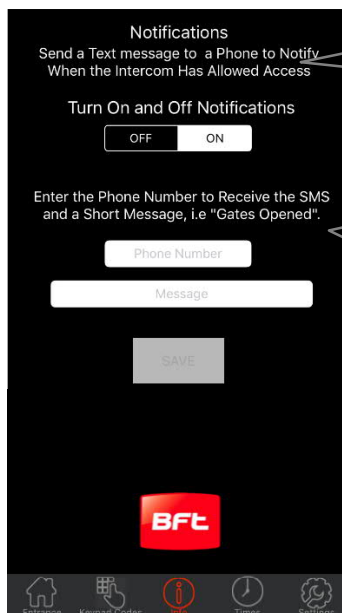

Can be used to send a SMS notification to a master user, each time someone calls the device and access is granted.

Toggle the feature on firstly. Then enter a phone number which will receive the notifications. Lastly enter a message like "Gates Opened"

Status Sub-Menu

The screenshot shows a mobile app interface for the 'Status' sub-menu. At the top, there is a 'Back' button and the title 'Status'. Below the title is a descriptive text: 'Check th Signal Strength and Stored Numbers on the Intercom. Check if the Gate is Open or Closed. Check Who Gained Access and When'. The main content area contains four buttons: 'Signal Strength', 'Stored Numbers', 'Gate Status', and 'Activity Log'. At the bottom, there is a navigation bar with icons for 'Entrance', 'Keypad Codes', 'Info', 'Times', and 'Settings'.

Check stored numbers – Will send SMS reply with O for dial out numbers and I for dial in (caller ID access numbers).

Check signal strength on your intercom. Level 1-31. Must be above 14 for successful operation.

Check last 20 users who triggered gates, including date and time (date is international format (DD/MM/YYYY))

Check the state of both relays (ON or OFF). ON = latched open state. Check status of gate limit switch (if fitted).

Check th Signal Strength and Stored Numbers on the Intercom. Check if the Gate is Open or Closed. Check Who Gained Access and When

Signal Strength

Stored Numbers

Gate Status

Activity Log

Entrance Keypad Codes Info Times Settings

Troubleshooting guide

Q. The unit will not power up. No LEDs on.

A. Check alarm or CAT5 cable has not been used to power the device. If it has, the warranty will be void. Please remove and replace as per instructions.

Q. The unit powers up but is not showing network reception or will not respond to SMS.

A. This means the unit is not able to detect the network for some reason.

-Check the SIM card is activated and has calling credit.

-Power off the unit, remove the SIM and check it in a mobile phone to verify it can make a call.

-Check the SIM does not ask for a PIN code when put in a phone. If it does, then disable the PIN code request.

-Check the SIM is a standard voice SIM and not a data only SIM for a tablet.

-Check the reception is strong. Poor reception is not sufficient.

- Check alarm or CAT5 cable has not been used to power the device. If it has, the warranty will be void. Please remove and replace as per instructions.

-Power off, remove the SIM, use fine sand paper or a sharp object to lightly clean the SIM pads and contacts on the GSM unit. Gently bend the contacts upwards so that they make better contact with the SIM and try again.

Q. The caller ID part does not work.

A. Be sure to program the caller ID part under 72 feature. If your number is a private or number withheld, then it will not work.

-Even if you have already programmed a number to receive a call from the device, if you also want that number to have caller ID access, it must be programmed under the 72 feature also.

-Ensure the number is entered as you would normally dial it from another phone.

Q. The keys do not work when the device calls a phone.

A. Check if you can hear the relay clicking at the gate when the keys are pressed during a call. If it can be heard, then the system is working, check wiring between the relay and the lock or gate panel. If the relays do not make a clicking sound, then check this feature on a different mobile cell phone or landline. If it works on a different phone, check the settings on the phone in question under DTMF tones.

Failure of DTMF tones to operate correctly is also a symptom of low reception. Check steps above on improving reception. Try pressing the buttons longer when attempting to activate the gates or door.

Also check that the relays are not already latched with the *22# command. If they are latched, they need unlatched before the trigger keys will work.

Q. The system was operating the gates fine, but now it will not trigger the gates.

Most of the time, this is caused by the user accidentally latching the relay. This latches the output relay permanently on. Send the intercom the following SMS *22#. The device should reply with a message detailing the relay status.. If it has been latched, then the message will state "the relay is ON". In this case refer to the user guide to read how to unlatch it again.

Q. The unit no longer calls out to phones but I can make a call to it from my phone.

A – Check there is balance on the SIM card.

A – Switch off the power, remove the SIM, put it into a phone, and check that a call can be made from a phone. This will verify if the SIM is still working and in service.

Change History

Key:

H = Hardware PCB version S = Software version

| Reason for change | | |
|-------------------|---|--|
| H | S | |
| 1 | 1 | First version. |
| 2 | 1 | Power chip upgraded to work on 24v dc (24v adaptor in kits). |
| 2 | 2 | Software feature added for call log to show last 25 caller ID calls. |
| 3 | 2 | Main capacitor, regulator & diode upgraded for 24v dc. |
| 4 | 2 | 24v ac power board added to allow 24v ac power input |
| 4 | 6 | PRIME model, new firmware, larger flash storage, Micro SIM holder, antenna connects direct to PCBA, Red colour PCBA, all black model design. |

