

# **Fingerprint Access Standalone User's Manual**

**V1.1.1**

## Table of Contents

1	Overview.....	1
2	Device Structure and Installation .....	2
2.1	Device Structure .....	2
2.2	Device Installation .....	3
3	System Structure .....	7
4	Function Setting.....	8
4.1	Login.....	8
4.2	User Management.....	8
4.2.1	Add User.....	8
4.2.2	Add Super Password .....	10
4.2.3	Delete User.....	11
4.2.4	Delete Password User .....	12
4.2.5	Add More Master Card.....	12
4.3	A&C .....	13
4.3.1	Period .....	13
4.3.2	Master Card.....	16
4.3.3	Unlock Mode.....	17
4.3.4	Door Lock Time.....	18
4.3.5	Alarm .....	18
4.3.6	Door Status Setup.....	19
4.4	System Settings.....	19
4.4.1	Local Setup.....	19
4.4.2	Network Mode.....	21
4.4.3	Mode.....	23
4.4.4	Reboot System .....	23
4.4.5	USB Upgrade.....	23
4.5	System Info.....	24
4.5.1	Unlock Record .....	24

4.5.2	Alarm History .....	25
4.5.3	Local Info .....	26
4.5.4	USB Export .....	27

## Important Safeguards and Warnings

P

Note:

- e
- a
- s
- e
- r
- e
- a
- d
- t
- h
- e
- t
- o
- l
- l
- o
- w
- Please change user default password after being armed.
  - Do not install the device at position exposed to sunlight or in high temperature. Temperature rise in device may cause fire.
  - Do not expose the device to lampblack, steam or dust. Otherwise it may cause fire or electric shock.
  - The device must be installed on solid and flat surface in order to guarantee safety under load and earthquake. Otherwise, it may cause device to fall off or turnover.
  - Do not drop or splash liquids onto the device, and do not place container with full liquid on the device to prevent liquid spilling from entering the device.
  - Do not block air vent of the device or ventilation around the device. Otherwise, temperature in device will rise and may cause fire.
  - Use the device only within rated input and output range.
  - Do not disassemble the device without professional instruction.
  - Please transport, use and store the product under appropriate temperature and humidity.

### Warning:

- n
- g
- s
- a
- f
- e
- g
- u
- a
- r
- d
- s
- a
- Please use battery properly to avoid fire, explosion and other dangers.
  - Please replace used battery with battery of the same type.
  - Do not use power line other than the one specified. Please use it properly within rated range. Otherwise, it may cause fire or electric shock.
  - Please use power supply matching SELV requirements, and IEC60950-1 Limited Power Source. Power supply shall follow requirements on device label.
  - For I-type structure product, connect it to power supply plug with GND protection.
  - If you use power plug or appliance coupler as disconnecting device, please maintain the disconnecting device available to be operated all the time.

### Privacy Protection Notice

n

d

w

a

r

n

i

n

As the device user or data controller, you might collect personal data of others' such as face, fingerprints, car plate number, Email address, phone number,

GPS and so on. You need to be in compliance with the local privacy protection laws and regulations to protect the legitimate rights and interests of other people by implementing measures include but not limited to: providing clear and visible identification to inform data subject the existence of surveillance area and providing related contact.

## About the Manual

- The Manual is for reference only. If there is inconsistency between the Manual and the actual product, the actual product shall prevail.
- We are not liable for any loss caused by the operations that do not comply with the Manual.
- The Manual would be updated according to the latest laws and regulations of related regions. For detailed information, see the paper User's Manual, CD-ROM, QR code or our official website. If there is inconsistency between paper User's Manual and the electronic version, the electronic version shall prevail.
- All the designs and software are subject to change without prior written notice. The product updates might cause some differences between the actual product and the Manual. Please contact the customer service for the latest program and supplementary documentation.
- There still might be deviation in technical data, functions and operations description, or errors in print. If there is any doubt or dispute, please refer to our final explanation.
- Upgrade the reader software or try other mainstream reader software if the Guide (in PDF format) cannot be opened.
- All trademarks, registered trademarks and the company names in the Manual are the properties of their respective owners.
- Please visit our website, contact the supplier or customer service if there is any problem occurred when using the device.
- If there is any uncertainty or controversy, please refer to our final explanation.

# 1 Overview

The Fingerprint Access Standalone integrates card reading, config and execution functions. Its has a neat appearance for medium to high-end clients such as commercial building, corporation and intelligent community.

It has:

- Touch keyboard + LCD display, TCP/IP protocol.
- Support unlock via card, fingerprint, password, card+password, card+fingerprint, card or password or fingerprint.
- Max support 3,000 fingerprints (default), max of 4,500 fingerprints (customized), 30,000 valid cards and 500 super-passwords.
- Max support 150,000 card records and 1024 alarm records.
- Door time out alarm, intrusion alarm, duress alarm, and door sensor alarm.
- Ring input.
- Add guest card, duress card, black/white list and patrol card, while support period of validity or times.
- Integrate card reader and single-door controller.
- Support 128 groups of period and 128 groups of holiday period.

## Warning:

If this product required external power, please use DC 12V 0.5A adaptor and the work temperature shall be within  $-5^{\circ}\text{C} \sim 55^{\circ}\text{C}$ .

## 2 Device Structure and Installation

### 2.1 Device Structure

Device appearance and dimension are shown as in Figure 2-1 and Figure 2-2.  
Unit is mm.

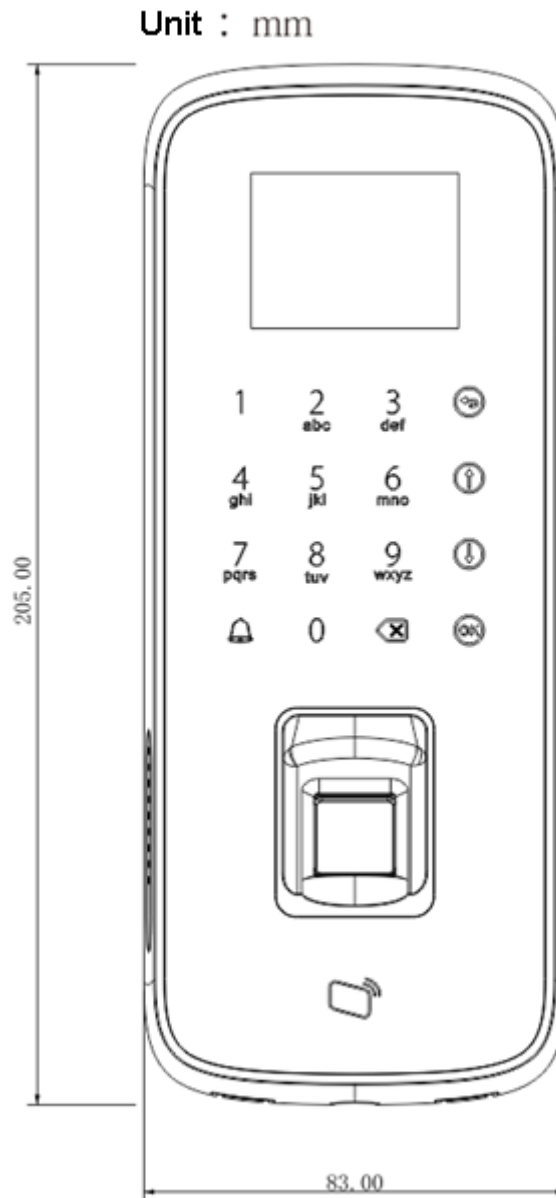

I

Unit : mm

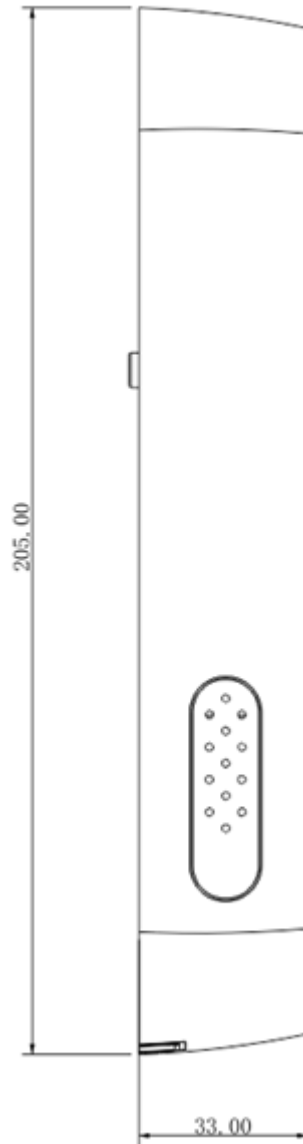

■

## 2.2 Device Installation

■

i  
g  
u  
r  
e

2

-

3

■

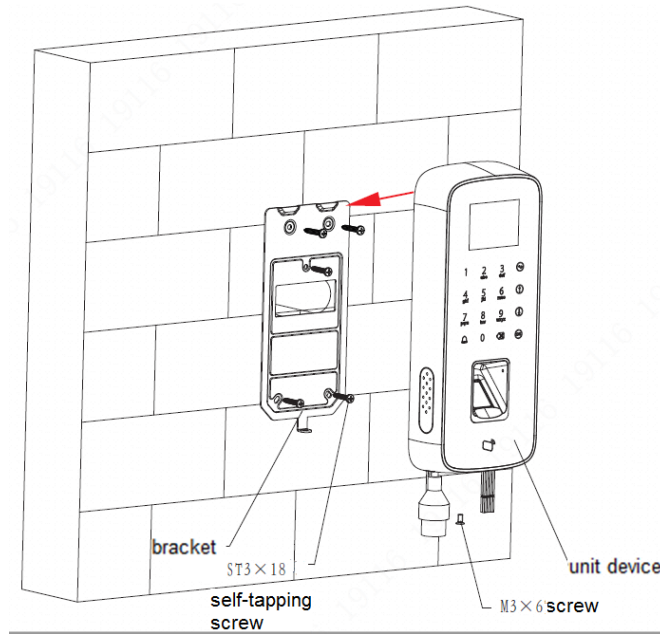

Installation step:

- Step 1. Fix bracket on installation surface with three ST3×18 self-trapping screws.
- Step 2. Connect wire, pull wire through slot on installation bracket, and place wire into installation surface. See Figure 2-4. Sequence of wire refers to Chart 2-1.
- Step 3. According to direction of arrow on installation map, hang device on bracket to complete installation.
- Step 4. From device bottom, screw one M3×6 screw, fasten bracket.



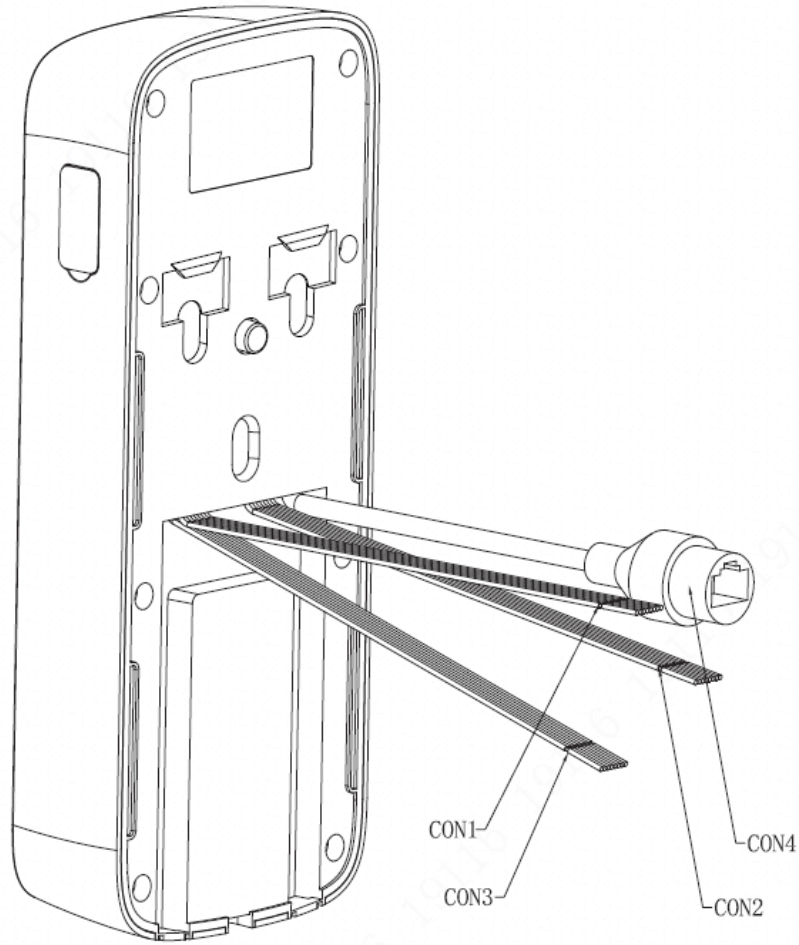

Port	No.	Color	Interface	Note	Protocol
CON1	1	Red	+12VI	DC 12V power input	-
	2	Black	GND	GND	
	3	Blue	COM	Lock COM	
	4	White	NC	Lock NC	
	5	Green	NO	Lock NO	
	6	Brown	SR	Door sensor	
	7	Yellow	GND	GND	
	8	Purple	PUSH	Unlock button	
CON2	1	Red	+12VO	DC 12V power output	-
	2	Black	GND	GND	-
	3	Blue	CASE	Card reader	Weigand protocol
	4	White	D1	Weigand line 1	
	5	Green	D0	Weigand line 0	
	6	Brown	LED	Weigand card indicator line	
	7	Yellow	B1	RS485B	RS485 protol
	8	Purple	A1	RS485A	
CON3	1	Red	BELL+	Ring	-

Port	No.	Color	Interface	Note	Protocol
	2	Black	BELL-		
	3	Blue	GND	GND	
	4	White	AOUT	Alarm output	
	5	Green	AIN	Alarm input	
	6	Brown	GND	GND	
	7	Yellow	B2	External RS485B	
	8	Purple	A2	External RS485A	
	CON4	-	-	RJ45	Network

■

### 3 System Structure

The device and card reader, alarm device, access control PC and etc. compose a system as in Figure 3- 1.

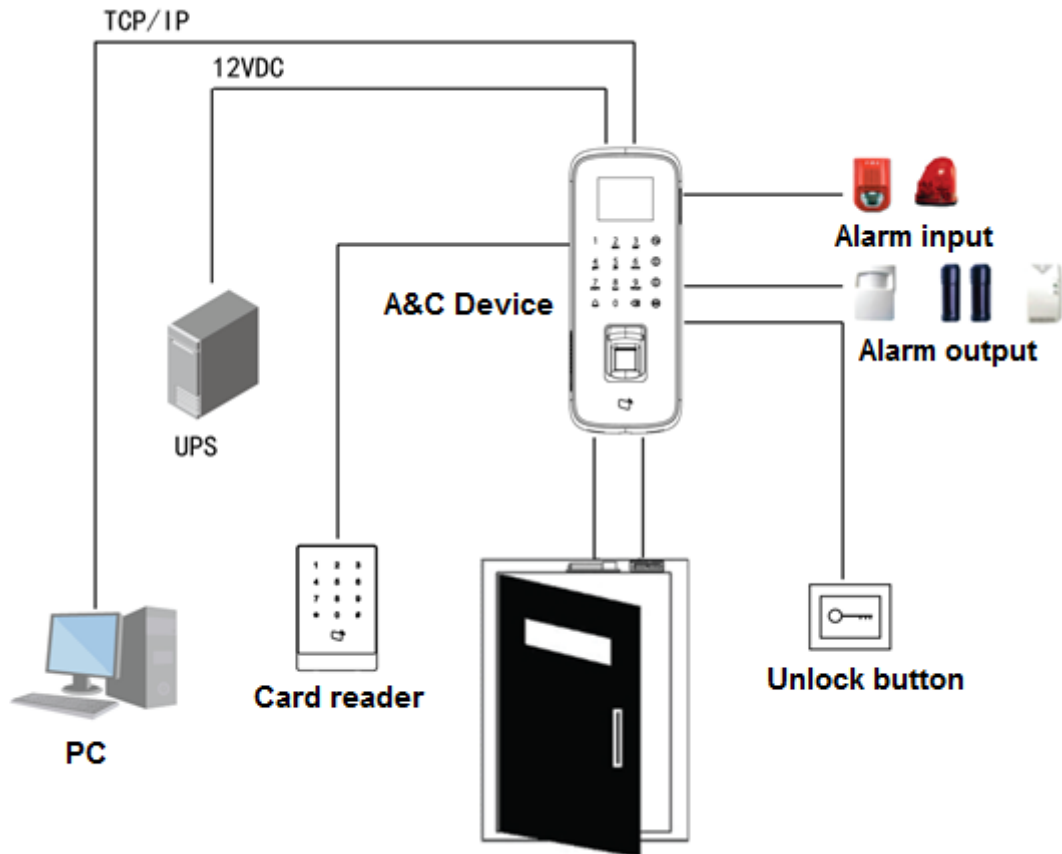

I

## 4 Function Setting

### 4.1 Login

Login interface step:

Step 1. Plug in power, device is going to boot up.

Step 2. Press 【OK】 button, screen displays admin password.

Step 3. Input admin password, and press 【OK】 button to enter homepage.

See Figure 4-1.

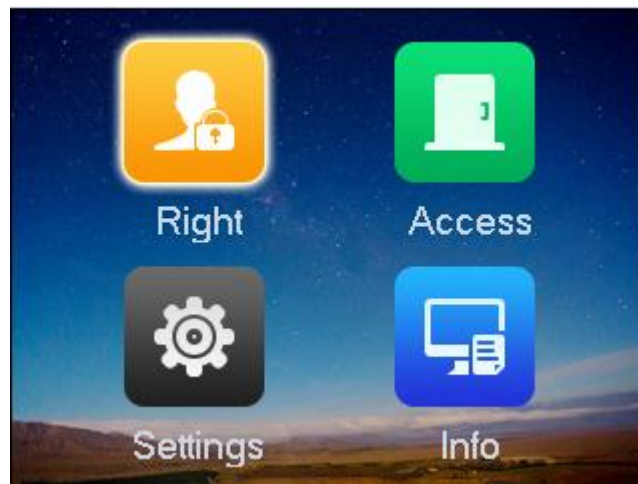

Default password is “88888888”. Please change admin password ASAP, see Ch 4.4.1.2.

You can select to enter right management, A&C setting, system setting and local info as main menu.

- Press 【↑】 button to move up.
- Press 【↓】 button to move down.
- Press 【OK】 button to enter or confirm.
- Press 【↶】 button to return or exit.
- Press 【<⊗】 button to backspace.
- Press 【🔔】 button to ring.

### 4.2 User Management

You can add or delete card, super password.

#### 4.2.1 Add User

You also can add user as you add card or fingerprint, and you can bind card and fingerprint.

**Note:**

- Card user has not set password, and you shall set unlock mode to card, card or password or fingerprint in order to enter.
- Card user set card password, and you shall set unlock mode to card, card + password, card or password or fingerprint in order to enter.
- Card user set fingerprint, but before entering, user shall set unlock mode to card, card + password, card or password or fingerprint.
- User, who set period, can only unlock door within designated period.

To add user:

Step 1. In homepage, select right, press **【OK】**.

Step 2. Select Add User, press **【OK】**. See Figure 4-2.

The screenshot shows a screen titled "Add User" with the following fields and values:

Field	Value
Card No.	003D62AC
UserID	1
Card Type	Normal
Use Time	255
Password	123456
Period	0
Validity	2037-12-31

Step 3. Use key to input card no. or place card at swiping area to scan.

Step 4. Enter user no.

Step 5. Select card type, press **【OK】** to select. See Chart 4-1.

Card Type	Note
General card	General user card. When you add card, system will ask if set card password, period and term of validity.
VIP card	VIP user card. It warns service personal when cardholder enters. When you add card, system will ask if set card password, period and term of validity.
Guest card	When you add guest card, you need to set usage times. So when it exceeds this limit, the card becomes invalid.
Patrol card	Patrol card can only swipe card at patrol spot but cannot unlock. When you add card, system will ask if set card password, period and term of validity.
Black list	When you swipe card on black list and enters, it warns

Card Type	Note
	service personal. When you add card, system will ask if set card password, period and term of validity.
Duress card	Duress card becomes valid after you set duress alarm. You can swipe this card to unlock, but an alarm will be send to center.

**Note:**

All of these cards will be sent to center, management platform will process according to card type.

Step 6. Press 【<X>】 to delete original data, and enter actual usage times you need.

Step 7. Press 【OK】 to delete default data, enter user password, time period and validity, and press 【<X>】 . System asks if you want to record fingerprint.

Step 8. Select YES or No as you need.

- Select YES, please follow system instructions to place fingerprint on reader to record for three times.
- Select NO, system shows operation is successful.

#### 4.2.2 Add Super Password

Password user represents user who input password in setup to enter.

Note:

- Password user, shall set unlock mode to password, card or password or fingerprint in order to enter.

To add super password:

Step 1. In right interface, select Add Super Password, and press 【OK】 .

System shows add new super password interface. See Figure 4-3.



- Step 2. Input super password no. and press 【↓】 .
- Step 3. Input super password and confirm. Press 【OK】 .

### 4.2.3 Delete User

You can delete a single user, or all users.

#### 4.2.3.1 Delete Single User

- Step 1. In right interface, select Delete User, press 【OK】 .
- Step 2. Select Delete Single User, press 【OK】 . and press 【OK】 key. See Figure 4-4.



Step 3. Delete user.

Please select any of the follow method:

- Enter card no. to delete and press OK.
- Scan card you want to delete at card swiping area, press 【OK】 .
- Enter user no. to delete, and press 【OK】 .

System asks if you want to delete.

Step 4. Select OK and click OK.

#### 4.2.3.2 Delete All Users

- Step 1. In delete user interface, select all users, and press 【OK】 key. System asks if to delete all or not.
- Step 2. Press 【OK】 key to confirm. System says deleted successfully.

## 4.2.4 Delete Password User

You can delete a single super password or delete all super passwords.

### 4.2.4.1 Delete Single Super Password

Step 1. In delete user interface, select delete super password, and press **【OK】** key.

Step 2. Select delete single super password and press **【OK】** key.

See Figure 4-5.



Step 3. Input no. of super password to delete, and press **【OK】** key.

System asks if to delete it or not.

Step 4. Press OK and press **【OK】** key to delete.

### 4.2.4.2 Delete All Super Passwords

Step 1. In delete super password interface, select delete all super passwords, and press **【OK】** key. System asks if to delete all or not.

Step 2. Press **【#】** key to delete.

Step 3. Select OK and press **【OK】** key. System says deleted successfully

## 4.2.5 Add More Master Card

By adding more master card, user can quickly add card user. Before adding master card, user shall add one master card first, please refer to Ch 4.3.2.

To add more master card:

Step 1. In user management interface, select add more master card, and press **【OK】** key. System prompt user to swipe the card.



- Step 2. Place master card on swiping area and scan. System prompts master card mode.
- Step 3. Place card to add one by one at the swiping area to scan. System says added successfully.

## 4.3 A&C

### 4.3.1 Period

You can set unlock period, including card swiping period, holiday period, mode period and NO period.

#### 4.3.1.1 Card Swiping Period

Card swiping period can be 0~127, a total of 128 periods. In each period, you need to set schedule for each day of week. When a new card is added, and set card swiping period, then user swipe card to unlock. Access control will judge if current time is within set period. For example, set period 1, and the Monday to Sunday setup are in Chart 4-2.

Day	Period
Monday	0800-2200 (valid period: 08:00 to 22:00)
Tuesday	0800-2200 (valid period: 08:00 to 22:00)
Wednesday	0800-2200 (valid period: 08:00 to 22:00)
Thursday	0800-2200 (valid period: 08:00 to 22:00)
Friday	0800-2200 (valid period: 08:00 to 22:00)
Saturday	0800-2200 (valid period: 08:00 to 22:00)
Sunday	0800-2200 (valid period: 08:00 to 22:00)

To set card swiping period:

- Step 1. In homepage, select A&C setup, and press **【OK】** key.
- Step 2. Select time period, and press **【OK】** key. Enter time setup interface.
- Step 3. Select card swiping period, and press **【OK】** key. See Figure 4-6.

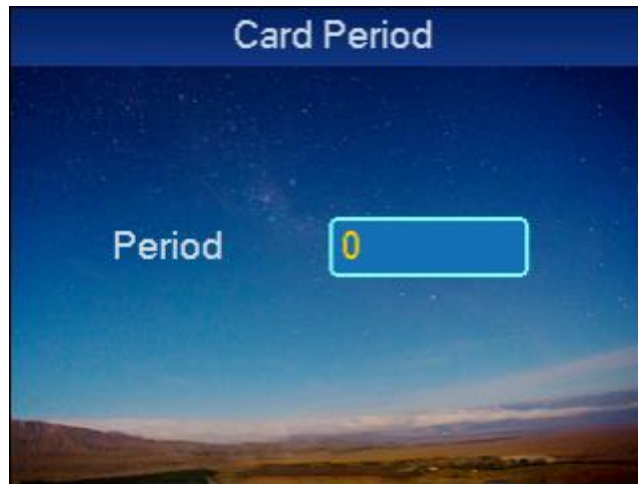

Step 4. Input time period, and press 【OK】key. Input any number between 0~127. Screen displays period. See Figure 4-7.



- Step 5. Select day of week, and press 【OK】 key.
- Step 6. Set other periods. System asks if save it or not.
- Step 7. Press 【OK】 key, system asks if to save config or not.
- Step 8. Select YES, and press 【OK】 key. System says saved successfully.

**Note:**

**Default period is full periods.**

#### 4.3.1.2 Holiday period

Holiday period setup includes lock hold time and timeout time.

- Lock hold time: after you swipe card, period the lock remains unlocked, it will auto lock once this period ends.
- Timeout time: after you swipe card, door remains unlocked exceeding this period, it will alarm.

To set holiday period:

- Step 1. In time period setup page, select holiday period, and press **【OK】** key.
  - Step 2. Input lock hold time and timeout time, and press **【<x>】** key. Input any number between 0~127, such as 1.
- See Figure 4-8.

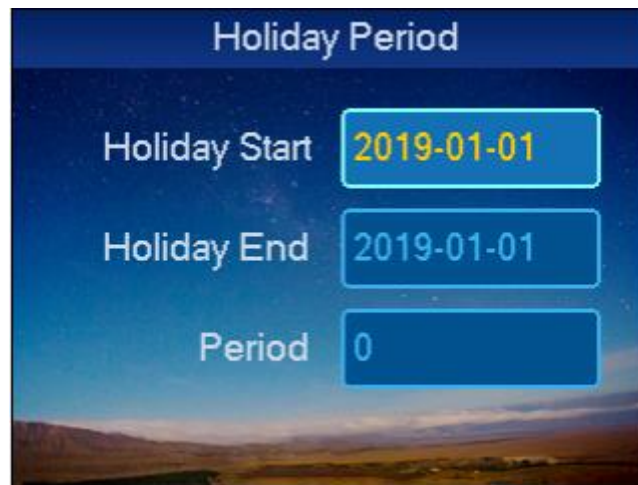

■  
■  
■

- Step 3. Enter holiday start time, holiday end time and period, press **【OK】** . System asks if you want to save.
- Step 4. Select YES, and press **【OK】** .

### 4.3.1.3 Mode Period

Mode period has four periods per day, from Monday to Sunday, 7 days a week.

To set mode period:

- Step 1. In time period setup interface, select mode period, and press **【OK】** . System displays periods of Monday to Sunday. See Figure 4-9.

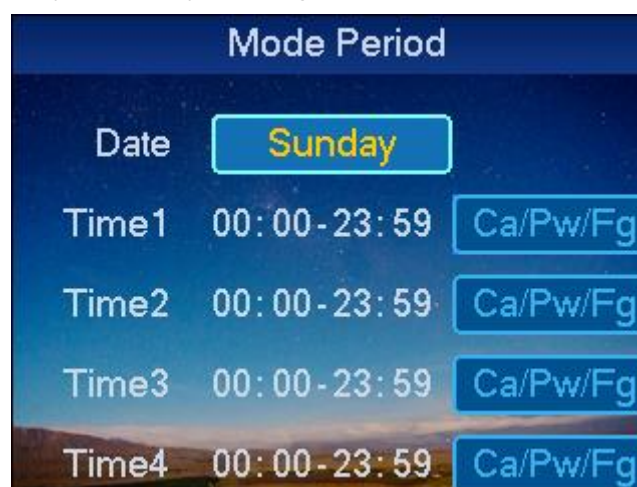

■

- Step 2. For example select Monday, and press 【OK】 key.
- Step 3. Config period, press 【OK】 to select unlock mode of the period
- Step 4. Config Tuesday to Sunday periods.
- Step 5. Press 【OK】 key. System asks if save or not.
- Step 6. Select YES, and press 【OK】 key. System says saved successful.  
After completion, A&C unlock method will be managed according to the four periods.

#### 4.3.1.4 NO Period

After user set NO period, A&C will be open during this period.

To set NO period:

- Step 1. In time setup interface, select NO period, and press 【OK】 key. See Figure 4-10.

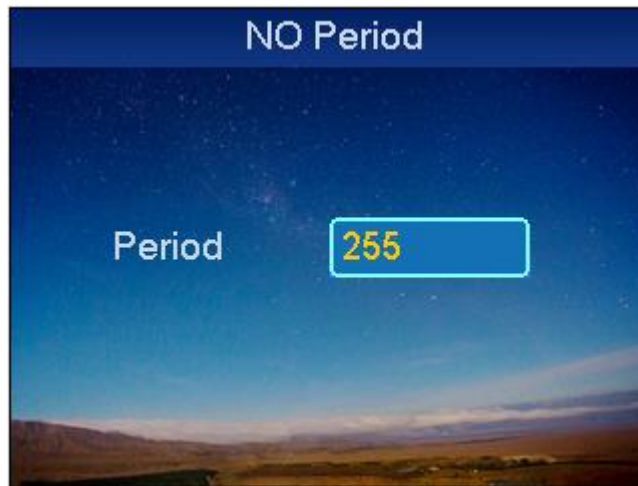

■

Note:

System prompts setup is successful. Period no. is the no. set in card swiping period setup.

- Step 2. Click 【<X】 to delete old data, enter period no., press 【OK】 .

#### 4.3.2 Master Card

You can modify or add master card.

- Step 1. In A&C setup interface, select master card setup, and press 【OK】key. See Figure 4-11.

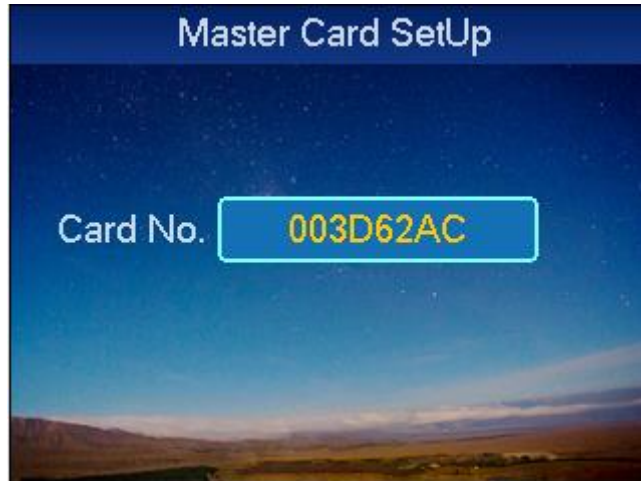

Step 2. Press 【<X>】 key to delete old card no., and input modified card no., or directly place the card at swiping area for scanning, and press 【OK】 key, as follows. System prompts setup is successful.

### 4.3.3 Unlock Mode

Unlock mode includes card, password, fingerprint, card+password, card+fingerprint, card or password or fingerprint.

To set:

Step 1. In A&C interface, select unlock mode, and press 【OK】 . Enter unlock mode setup page. See Figure 4-12.

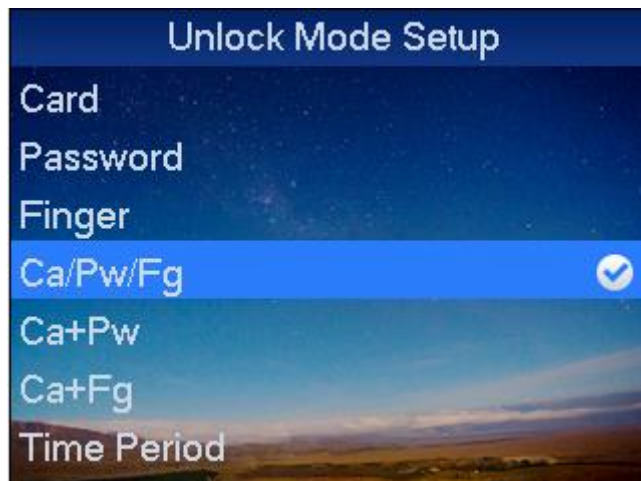

Step 2. Select mode to set, and press 【OK】 key. When it is selected, there will be a ✓ next to the mode.

### 4.3.4 Door Lock Time

Door lock time setup includes hold time and over time setup.

Step 1. In A&C setup, select door lock time setup and press **【OK】** key. See Figure 4-13.



Step 2. Press **【<X>】** key to delete original data, input hold time and over time, press **【OK】** key.

System prompt setup is successful.

**Note:**

**Door lock hold time is the time door remains open after user swipe card. If the door remains open exceeding “over time”, it will send alarm.**

### 4.3.5 Alarm

User can enable or disable alarm, system alarm includes intrusion, anti-pass back, duress card, door sensor and door timed out. Please refer to Chart 4-3.

Alarm Type	Note
Intrusion	Enter without valid card swiping or password, it will generate an alarm.
Anti-pass back	Must swipe card when enter/exit, otherwise it will generate an alarm.
Duress Card	Enter with duress card, it will generate an alarm.
Door Sensor	When A&C device is damaged, it will generate an alarm.
Door Timed Out	When A&C open time is over Door Over time, it will generate an alarm. Door timed out alarm requires setup of door over time, please refer to Ch 4.3.4.

To set alarm:

Step 1. In A&C interface, select alarm setup, and press **【OK】** key. Enter alarm setup interface. See Figure 4-14.



Step 2. Select alarm to turn ON, and press **【OK】** key as follows. Press **【OK】** key again to close the alarm.

### 4.3.6 Door Status Setup

You can set A&C status to normal, NO or NC.

Step 1. In A&C setup interface, select door status setup, and press **【OK】** key to enter door status setup interface.

Step 2. Via **【↑】** and **【↓】** select needed A&C status, and press **【OK】** key. After selection is successful, a  will be shown next to door status.

## 4.4 System Settings

### 4.4.1 Local Setup

You can set data, admin password and voice mail. You also can export all data, restore default settings.

#### 4.4.1.1 Date Setup

It sets current system date and time.

Step 1. In system settings page, press **【↑】** or **【↓】** key, select date setup, and press **【OK】** key.

Step 2. Select local setup, and press **【OK】** key.

Step 3. Select date setup, and press **【OK】** key. See Figure 4-15.

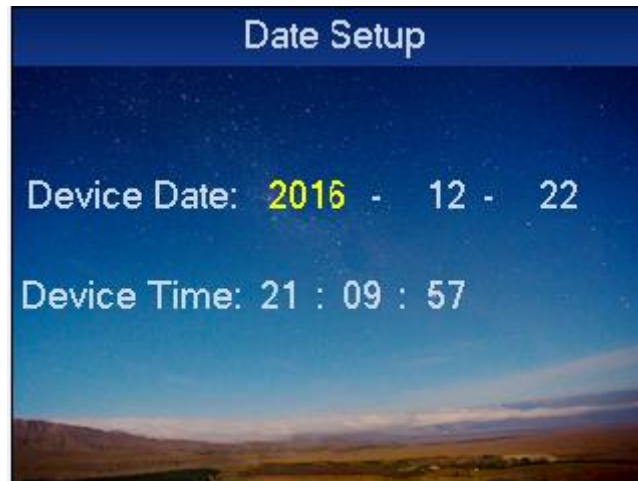

■

Step 4. Input device date and device time, and press **【OK】** key. System prompts setup is successful.

#### 4.4.1.2 Admin Password Change

You can modify admin password.

Step 1. In local setup interface, select admin password setup, and press **【OK】** key. See Figure 4-16.



■

Step 2. Input old password, new password, confirm password, press **【OK】** key.



System prompts setup is successful.

#### 4.4.1.3 Talk Volume

You can set device audio volume.

Step 1. In local setup interface, select talk volume setup, and press **【OK】** as follows.

See Figure 4-17.

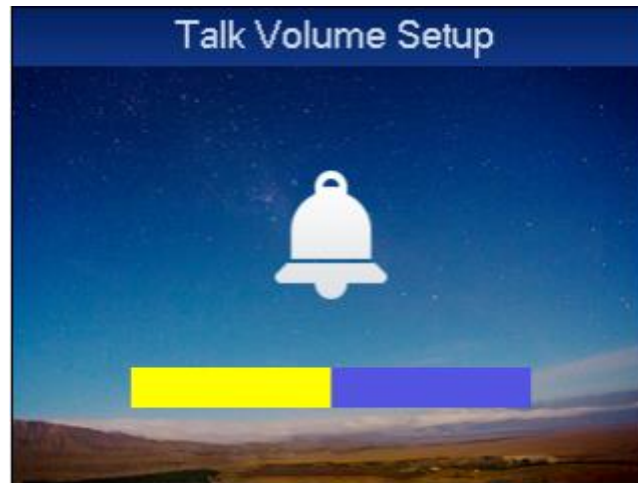

■

Step 2. Press **【↑】** key or **【↓】** key, you can adjust volume.

#### 4.4.1.4 Default

To restore default settings:

Step 1. In local setup interface, select default, and press **【OK】** key.

System asks if to restore or not.

Step 2. Select YES and press **【OK】** key to restore.

### 4.4.2 Network Mode

#### 4.4.2.1 Network Mode Setup

Step 1. In homepage, select Setting, press **【OK】** .

Step 2. Select Network Setup, press **【OK】** .

Step 3. Select Network Mode Setup, press **【OK】** .

See Figure 4-18.



Step 4. Press **【↑】** or **【↓】**, select network mode to enable, and press **【OK】** to confirm.  
 Press **【OK】** again to close network connection mode, see Chart 4-4.

Network Type	Note
DHCP	Auto gets IP function. When you enable DHCP “IP address”, “subnet mask” and “default gateway” are unavailable set.
P2P Enable	No need to apply for dynamic domain, mapping port or deploying server.

#### 4.4.2.2 IP Setup

Step 1. In Network Setup interface, select IP Setup, press **【OK】** .See Figure 4-19.



Step 2. Modify IP, subnet mask and gateway, press **【OK】** .

### 4.4.3 Mode

The device supports two work modes, including “this device as controller” and “this device as card reader”.

- This device as controller: the device is used as an A&C controller for unlock operation.
- This device as card reader, the device is used as a card reader, if you need to control door unlock, then it must be connected to an A&C controller before it can be used.

To set device mode:

Step 1. In system setup interface, select mode setup, and press **【OK】** key.

Step 2. Select work mode, and press **【OK】**. See Figure 4-20.

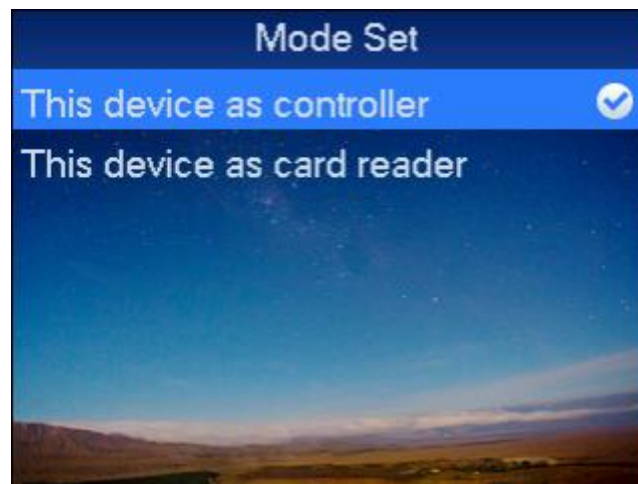

Step 3. Press **【↑】** key or **【↓】** key, select work mode, and press **【OK】** key as follows. After selection is successful, a  $\phi$  will be shown next to work mode.

### 4.4.4 Reboot System

To reboot the system:

Step 1. In main interface, and press **【OK】**.

Step 2. Select Reboot and press **【OK】**. System asks if to reboot or not.

Step 3. Select YES, and press **【OK】** key to reboot.

### 4.4.5 USB Upgrade

Step 1. Rename upgrade file as “AutoUpDate.bin” and save it in USB root directory, insert USB into device.

Step 2. In homepage, select Setting, click OK.

Step 3. Select USB Upgrade, click OK. See Figure 4-21.



■

Step 4. Via 【↑】 and 【↓】 key, select Yes, and click OK. System starts to upgrade, and it will reboot auto when upgrade is complete.

## 4.5 System Info

You can view device card swiping info, alarm info and local info.

### 4.5.1 Unlock Record

To view card swiping record:

Step 1. In homepage, select system info, and press 【OK】 key.

Step 2. Select unlock record, and press 【OK】 key. See Figure 4-22.



■

Step 3. Press 【↑】 key or 【↓】 key, select view method.

- View all unlock history.

Select View all unlock records, and click OK. You can view unlock record info,

including time, card no., mode and status.

- View record by period.
  1. Select View record by period, and click OK.  
See Figure 4-23.



2. Enter start time and end time, and click OK.  
It shows corresponding unlock record info.  
Note:  
Max 150,000 records can be shown.

## 4.5.2 Alarm History

To view alarm history:

- Step 1. In system info interface, select alarm history, and press **【OK】** key.
- Step 2. Select alarm record, and press **【OK】**, see Figure 4-24.



- Step 3. Press **【↑】** or **【↓】**, select view method.
  - View all alarm records  
Select View all alarm records, and click OK to view alarm type, alarm time and etc.

- View record by period
  1. Select View record by period, and click OK. See Figure 4-25.



2. Enter Start time and End time, click OK. It shows alarm record info in corresponding period.

**Note:**

**Max can display 1024 records of history.**

### 4.5.3 Local Info

To view local info:

Step 1. In homepage, select local info, and press 【OK】 key.

Step 2. Select Local Info, and press 【OK】 . See Figure 4-26.



You can view version, MAC, IP, Card Quantity, Super Password Quantity, Card History and Alarm History in the shown interface.

**Note:**

Figure here is for reference only.

## 4.5.4 USB Export

You can export unlock record and alarm record to USB disk to import/export config.

Step 1. In homepage, select Info, and click OK.

Step 2. Select USB Export, and click OK, see Figure 4-27.



Step 3. Click 【↑】 or 【↓】 key to select.

Parameter	Note
Export all unlock records	Select Export all unlock records, and press OK.
Export unlock records by period	1. Select Export unlock records by period , and click OK. 2. Enter Start time and End time, click OK.
Export all alarm records	Select Export all alarm records, click OK.
Export alarm records by period	1. Select Export alarm records by period, and click OK. 2. Enter Start time and End time, click OK.
Export configuration	Select Export configuration and click OK.
Import configuration	Select Import configuration and click OK.

### Note:

- This manual is for reference only. Slight difference may be found in user interface.
- All the designs and software here are subject to change without prior written notice.
- All trademarks and registered trademarks are the properties of their respective owners.
- If there is any uncertainty or controversy, please refer to the final explanation of us.
- Please visit our website or contact your local service engineer for more information.

