

# Blackjack® P-RACK

Servers Powered by DW Spectrum® IPVMS

State of the art hyper-optimized video management platform designed for ease, speed and efficiency.

**Blackjack® P-RACK — Up to 64 (1U) and 128 (2U) 2.1MP Cameras (1080p True HD Resolution)**

P-RACK-LX			P-RACK		
DW-BJP1U-LX	DW-BJP2U-LX	DW-BJPR2U-LX	DW-BJP1U	DW-BJP2U	DW-BJPR2U



DW-BJP1U-LX  
DW-BJP1U





DW-BJP2U-LX  
DW-BJP2U  
DW-BJPR2U-LX  
DW-BJPR2U

Default Login Information for DW Spectrum® IPVMS

Username: <b>admin</b>	Password: <b>admin1234</b>
------------------------	----------------------------

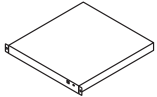
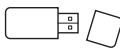
## WHAT'S IN THE BOX

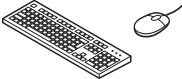
P-RACK Server		1 Set	Recovery USB (LX models only)		1 Set	Power Cable		1 Set
Quick Start Guide		1 Set	Keyboard and Mouse		1 Set			

**NOTE:** Download All Your Support Materials and Tools in One Place

1. Go to: <http://www.digital-watchdog.com/support-download/>
2. Search your product by entering the part number in the 'Search by Product' search bar. Results for applicable part numbers will populate automatically based on the part number you enter.
3. Click 'Search'. All supported materials, including manuals, Quick Start Guides (QSG), software and firmware will appear in the results.

**Attention: This document is intended to serve as a quick reference for initial set-up. See the DW Spectrum full manual for more information on features and functionality.**

# Blackjack P-RACK

Servers Powered by DW Spectrum® IPVMS

## BLACKJACK P-RACK HARDWARE

Front 1U Models

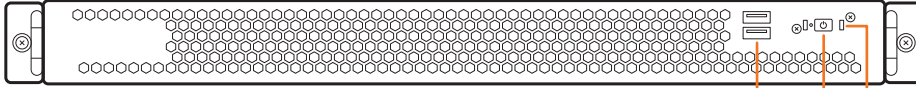

Front 2U Models

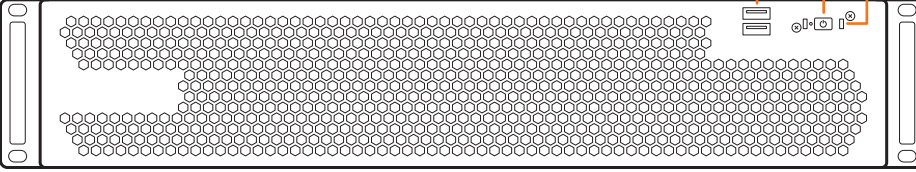

- F1** 2x USB 2.0 Ports
- F2** Power Button
- F3** HDD Status LED

Back 1U Models

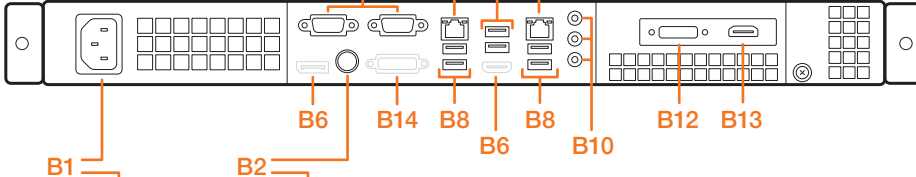

Back 2U Models

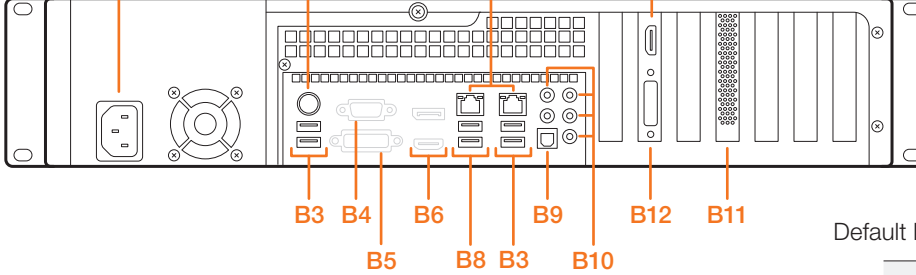

- B1** Power Output
- B2** Keyboard Port (PS2 type)
- B3** USB 2.0 Ports
- B4** VGA Output (Disabled)
- B5** DVI-D Output (Disabled)
- B6** True HD Output (Disabled)
- B7** Network Ports
- B8** USB 3.0 Ports
- B9** Optical Digital Audio Output
- B10** Audio Ports
- B11** RAID\* (DW-BPR2U models only)
- B12** DVI-I Output
- B13** HDMI Output
- B14** DVI-I Output (Disabled)
- B15** Command Ports

Default Login Information for Pre-Installed DW Spectrum® IPVMS

Username: <b>admin</b>	Password: <b>admin1234</b>
------------------------	----------------------------

## SPECIFICATIONS P-RACK

MODEL	Blackjack P-RACK 1U	Blackjack P-RACK 2U	Blackjack P-RACK 2U w/RAID	
Maximum IP Cameras	64		128	
Included IP Licenses	4		4	
Form Factor	Rack Mount		Rack Mount	
Operating System	Windows® 10 64 bit	DW-BJP1UXT	DW-BJP2UXXT	
	Linux® Ubuntu®	DW-BJP1UXT-LX	DW-BJP2UXT-LX	
OS on SSD	80GB SSD	80GB SSD	80GB SSD	
			Option: DW-SSD64 - Spare SSD for Mirroring the OS *	
CPU	Intel® i5® Processor		Intel® i7® Processor	
	Option: DW-CPUi7 - Upgrade Processor to i7 *			
Memory	8GB		16GB	
	Option: DW-RME8 - Upgrade Memory to 16GB *			
NIC	2x Gigabit Ethernet (RJ45)		2x Gigabit Ethernet (RJ45)	
			Option: DW-R2NIC - Upgrade DUAL 1GB NIC Card OR DW-R4NIC - Upgrade QUAD 1GB NIC Card *	
System	Max Video Storage Rate (Mbps)	360 Mbps	600 Mbps	
	Maximum Hard Drives	1 x SSD + 3 x HDD	2 x SSD + 6 x HDD	6 x HDD
Storage	Maximum Storage	18TB	36TB	30TB RAID 5
	Outputs		True HD Output or VGA or DVI	
Video-Out	Video Card		GeForce 210 512MB	
			Option: DW-RV4H - 4 head HD Video Card *	
	Resolution		HD 1080p	
Pre-Loaded VMS Software		DW Spectrum® IPVMS		
Unlimited Remote Clients		Cross Platform - Windows®, Linux® and Mac®		
Mobile Apps		iOS® and Android®		
Keyboard & Mouse		Included		
Railkit		Included		
Power	300W **		400W **	
Operating Temperature and Humidity		41°F-104°F / 20-90% RH		
Dimension (WxDxH) (inches)	17.25" x 20.85" x 1.75"	17.32" x 26" x 3.5"	17.32" x 26" x 19"	
Warranty		5 Year Limited		

# SETTING UP THE P-RACK

**STEP 1:** Connect Peripherals, power and network

- 1. Connect a monitor, USB keyboard, USB mouse and network cable to one of the ethernet ports (B7 on the diagram).  
Configure the camera network first then will configure local network later.
- 2. Connect the server to an appropriate power source. Recommend to use UPS system.  
\* Recommend to use 750VA or higher 1U P-RACK and 1000VA or higher for the 2U P-RACK
- 3. Turn on the server if the server does not turn on automatically.  
(Press the Power Button on the front of the P-RACK. F2 on the diagram).  
\* Connecting the power cable to the live power source may turn on the server automatically

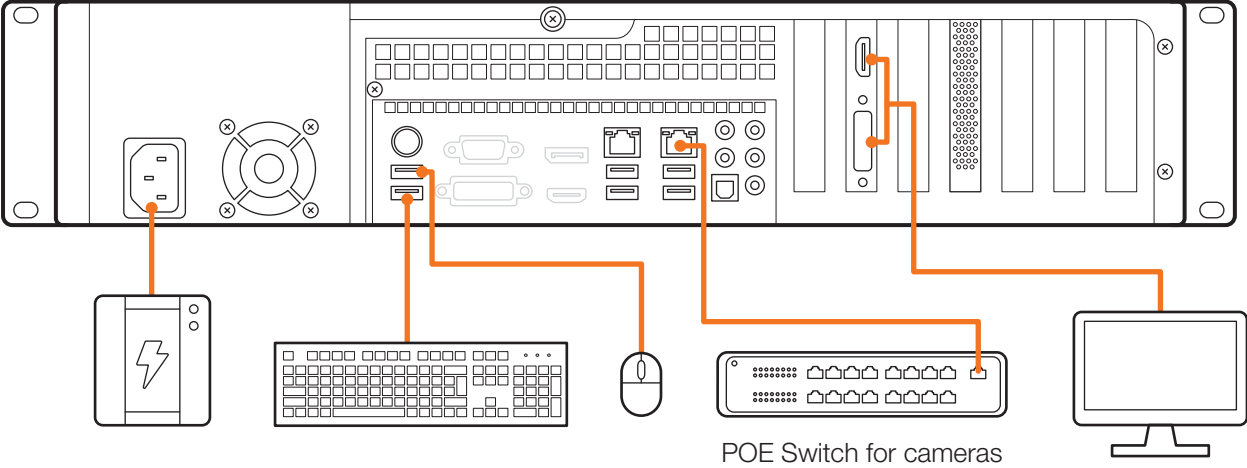
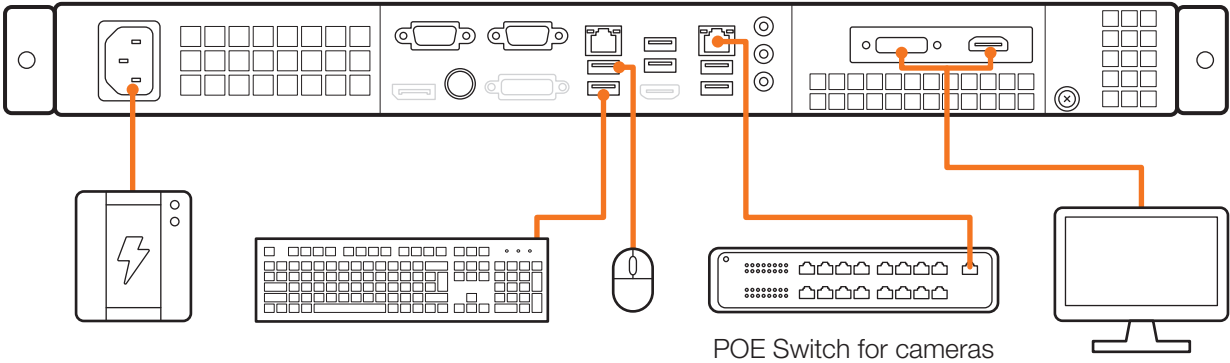

**STEP 2:** Configure Date and Time

**Windows**

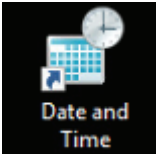

- 1. Double click Date and Time icon on the Desktop.
- 2. Change Time zone if not correct Change time zone... (default is UTC-08:00 Pacific Time)

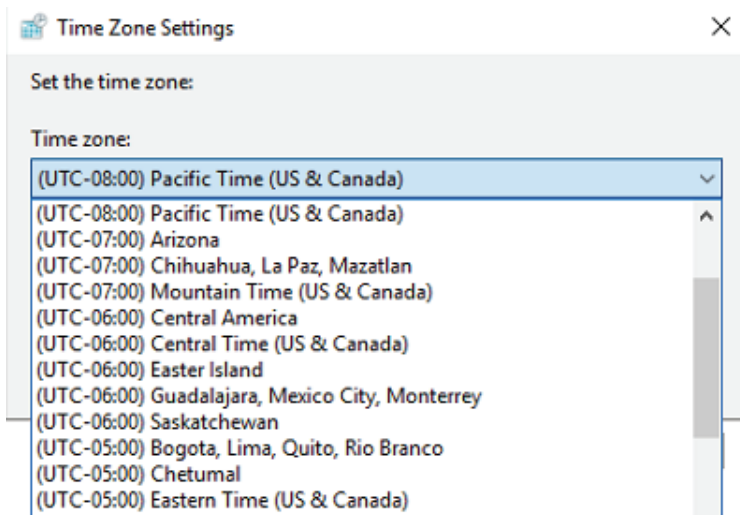

Press OK after selecting the correct Time zone.

Click “Change date and time...” to update the date and time if they are not correct.

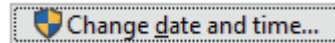

\* Verify the Time zone before updating the date and time. Time may show 2 or 3 hours off due to incorrect Time zone.

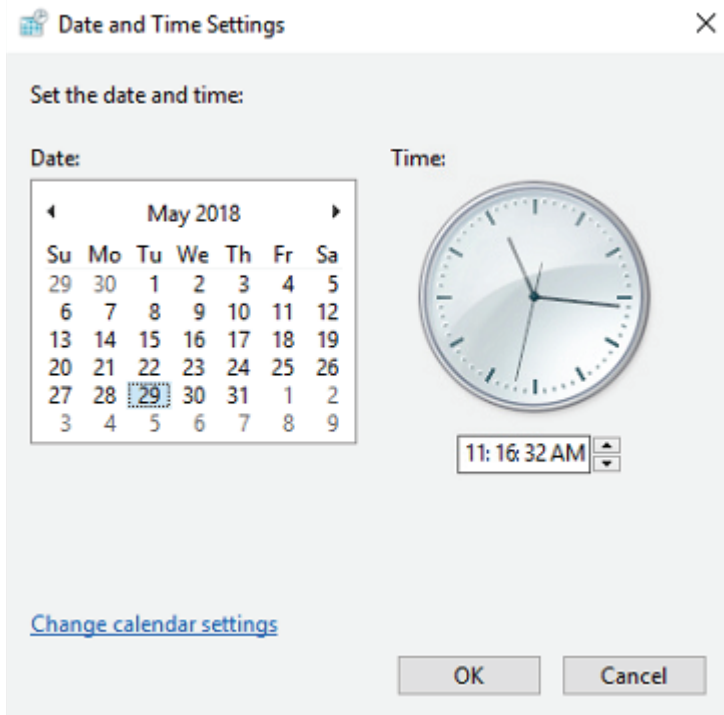

Press OK after adjusting to the correct date and/or time.

4. Press OK to close Date and Time when done.

## Linux

1. Update Date and Time by clicking on the time on the upper right-hand corner then click “Time & Date settings...”

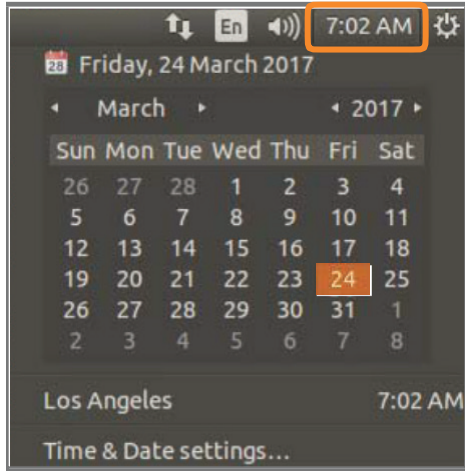

2. If the server will be connected to the Internet, leave Set the Time to “Automatically from the Internet” and update the Location to the correct Time Zone. Enter the nearest major city to select the correct Time Zone. If it shows multiple cities in the list, select the correct city. (e.g., New York for EST, Chicago for CST, Denver for MST, and Los Angeles for PST)

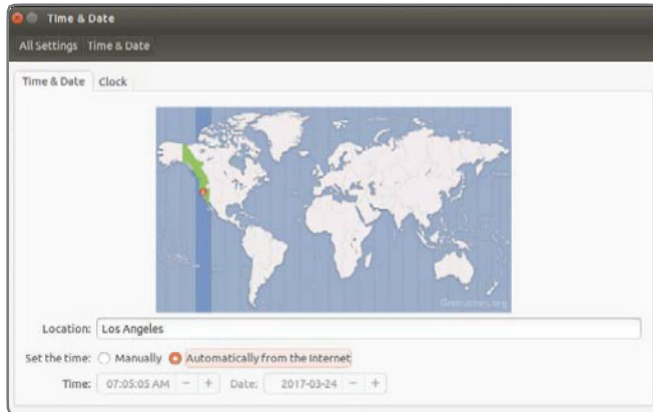

3. Click X on upper left corner of the Time and Date window when done.

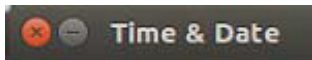

\* Closing the window will automatically save the changes made.

## STEP 3: Configure Network

Please have the following information ready before starting the network configuration.

	Camera Network	Local Network (LAN)
IP Address		
Subnet Mask / Netmask		
Default Gateway / Gateway	Not Applicable	
DNS Servers	Not Applicable	

\* Camera Network and Local Network cannot be on the same network.

**NOTE** The Blackjack P-RACK's network settings are set to DHCP as default.

**NOTE** If you are not sure what information to enter, contact your Network Administrator or Internet Service Provider for the information.

## Windows



1. Double click Network Connections on the Desktop
2. Right click on the Ethernet with cable connected and click Properties.

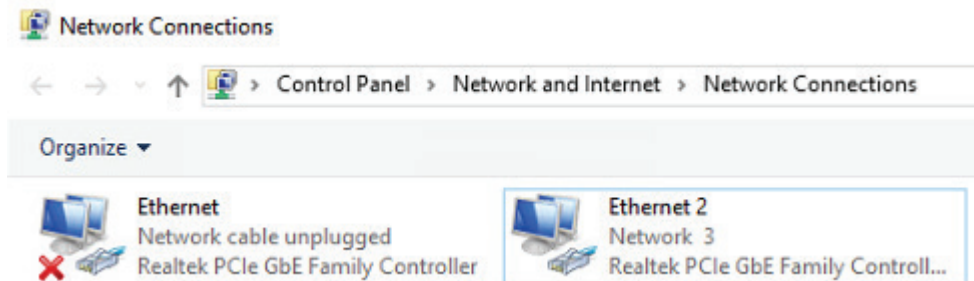

3. Click Internet Protocol Version 4 (TCP/IPv4) and click Properties

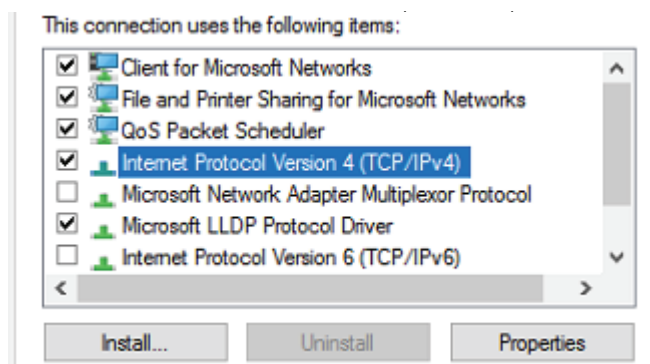

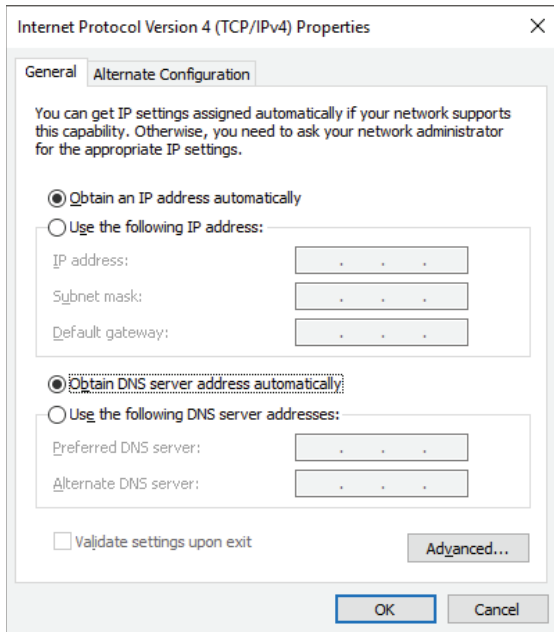

4. Select Use the following IP address (Use the following DNS server addresses will be selected automatically)
5. Enter IP address and Subnet mask of the camera network. (Do not enter anything for the Default gateway, Preferred DNS server and Alternate DNS server.)

**NOTE** It must be the same network as the cameras and must not be the same network as the local network. Contact your network administrator for more information.

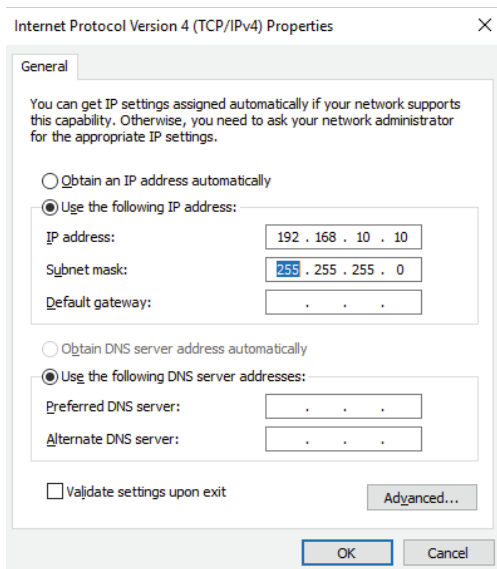

6. Click OK to close then click Close to go back to Network Connections.

## Local Network

7. Right click on the other Ethernet, the one with network cable unplugged, and click Properties.
8. Click Internet Protocol Version 4 (TCP/IPv4) and click Properties

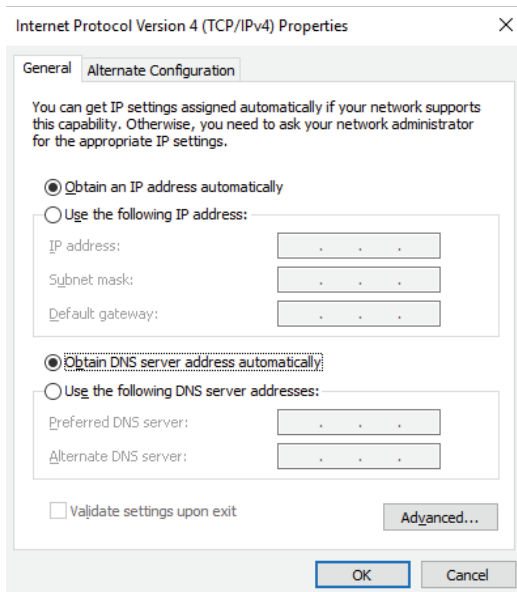
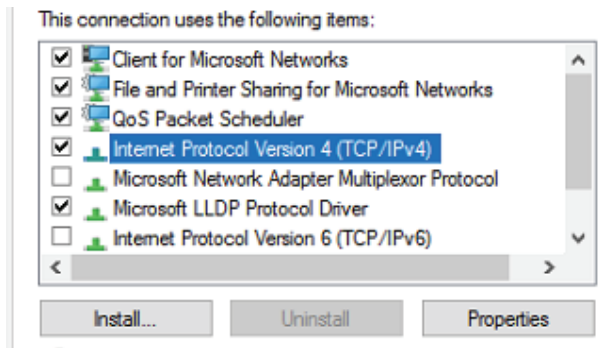

9. Select Use the following IP address (Use the following DNS server addresses will be selected automatically)

10. Enter IP address and Subnet mask of the camera network.

\* Consult with your IT department if you do not know what IP address to use.

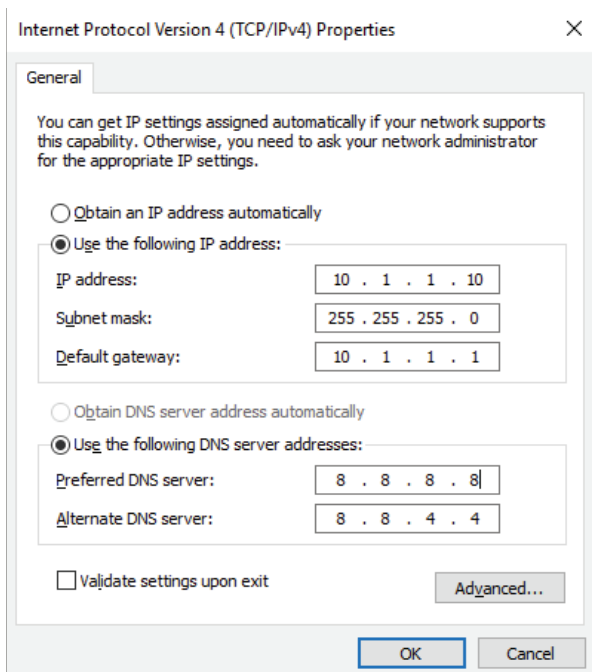



11. Click OK to close then click Close to go back to Network Connections.
12. Connect a network cable to the Ethernet port B8 on the diagram (page 2) to the switch on the local network.
13. Close the Network Connections by clicking X on the upper right corner of Network Connections.

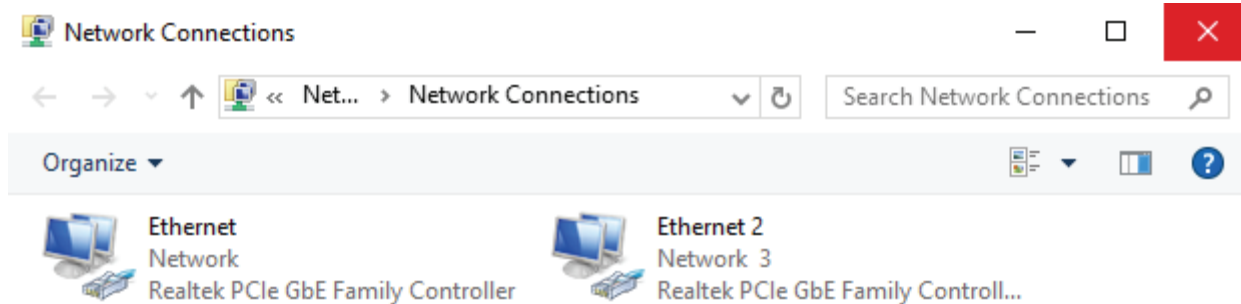

## Linux

1. Double-click the Network icon  on the Desktop

**NOTE** The Blackjack Cube's network settings are set to DHCP as default.

2. Select 'Wired' that has arrows pointing up and down from the list (If neither of the "wired" are showing arrows up and downs, then make sure the network cable is connected to the PoE switch on the camera network from **STEP 1**)
3. Click 'Options' at the bottom of the window.
4. Click on the 'IPv4 Settings' tab.
5. From the drop-down menu, select connection type ("Method") as Manual.
6. Click 'Add' next to Addresses.

7. Enter IP Address then press Tab on the keyboard to move to Netmask.

Address	Netmask	Gateway
192.168.40.7		

8. Ignore any populated values and enter the valid Netmask value, then press Tab on the keyboard to move to the Gateway.

Address	Netmask	Gateway
192.168.40.	255.255.255.0	

9. Enter the Gateway address if required then press Enter on the keyboard.

\* Gateway is not required on the camera network.

Address	Netmask	Gateway
192.168.40.7		

**NOTE** It must be the same network as the cameras and must not be the same network as the local network. Contact your network administrator for more information.

10. Click 'Save' to save the settings.

11. In the Network Settings main page, make sure the Wired Status is marked as "Connected" or "Managed" With the IP Address displayed.

**Wired**  
Connected - 100 Mb/s

Hardware Address 00:E0:53:17:84:BA  
IPv4 Address 192.168.40.7  
IPv6 Address fe80::8686:f6f8:2c8:5e9

Local Network

12. Select Wired with picture of network port and repeat 2 to 8 of STEP 3 Configure Network.

**Wired**

**Wired**

13. Click on the DNS Servers field box and enter DNS server address.

DNS servers:

14. Click Save.

15. Connect a network cable to the Ethernet port B8 on the diagram (page 2) to the switch on the local network.

16. Verify the network is Connected.

**NOTE** If you are not connecting to the Blackjack® from within the same network, you may be required to perform port forwarding on your router to access the server. Contact your Network Administrator or Installer for additional information

# CONFIGURE CAMERAS USING DW IP FINDER

Refer to the camera's QSG to configure Digital Watchdog camera's IP address using DW IP finder.

## Spectrum Client

 **LINUX-BASED SOFTWARE MANUAL LAUNCH**  
To launch the DW Spectrum® Software on the Linux-Based P-RACK

**OPTION 1:** Double-click the DW Spectrum® desktop icon.



**OR**

**OPTION 2:** Go to the dashboard on the top left side. Search 'DW'. Click the DW icon.

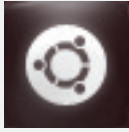

 **WINDOWS-BASED SOFTWARE MANUAL LAUNCH**  
To launch the DW Spectrum® Software on the Windows-Based P-RACK:

**OPTION 1:** Double-click the DW Spectrum® desktop icon.



**OR**

**OPTION 2:** Go to 'Start' on the bottom left and select DW Spectrum® in the Digital Watchdog folder

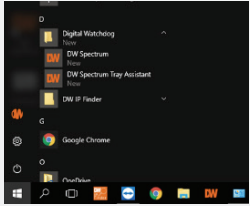

## SETTING UP DW SPECTRUM® MEDIA SERVER

Login : admin  
Password : admin1234

### STEP 1: Initial run from Blackjack® server

1. Open DW Spectrum® Client by double click on the DW Spectrum icon
2. Click on the preconfigured server.

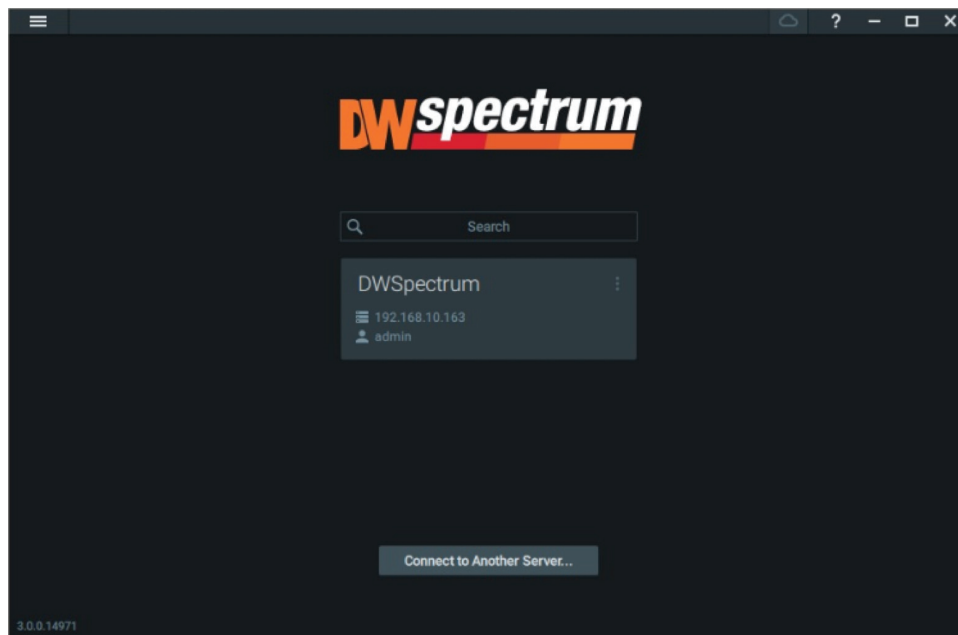

3. Enter password and click connect.

\* Default password : **admin1234** (case sensitive)

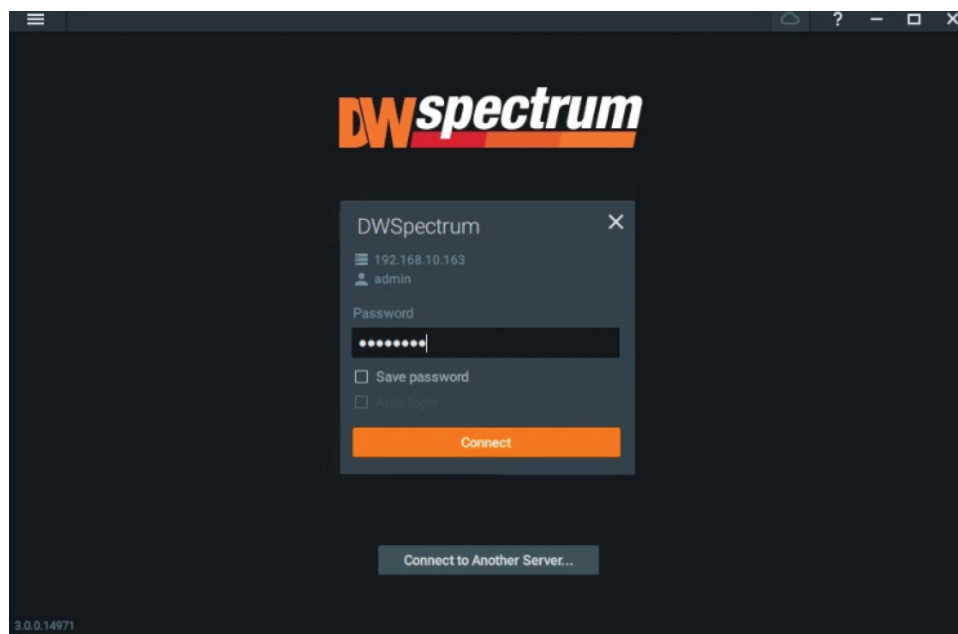

## STEP 2: To rename the server

1. Right click on the server name listed on the Resources then click Server Settings.

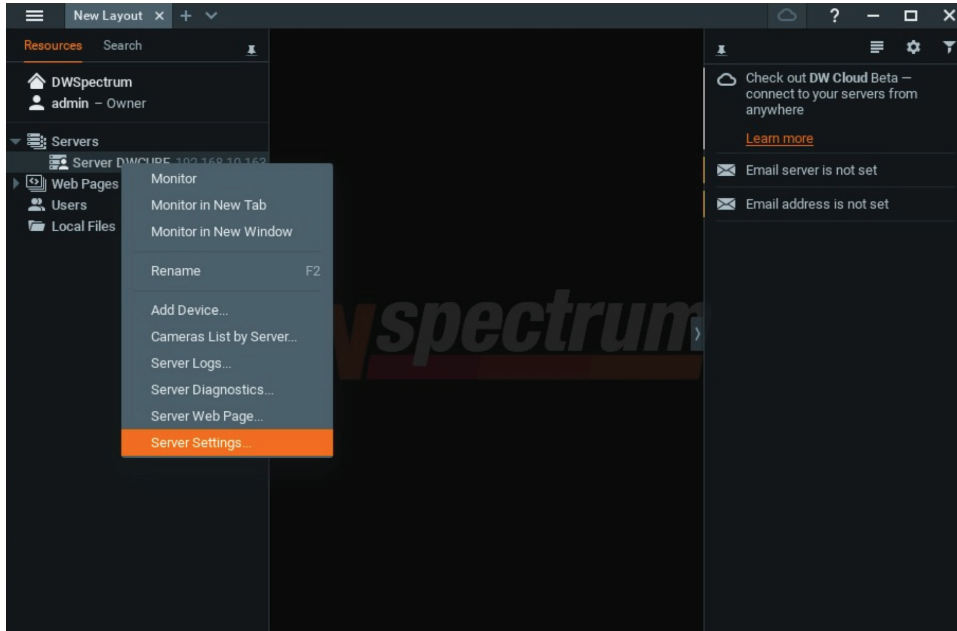

2. Go to General tab, then type in the new server name in the Name field and click OK.

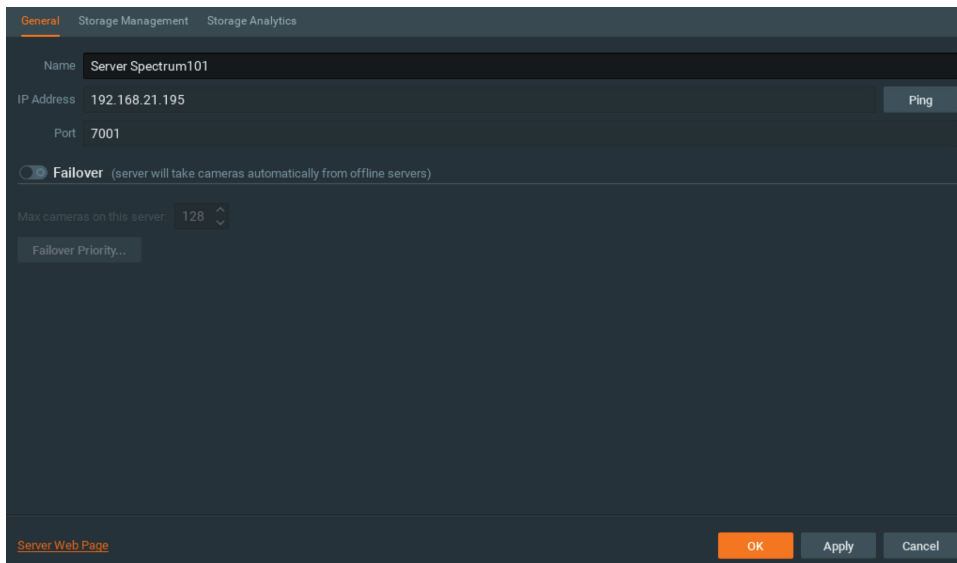

## STEP 3: To check for update

1. Click on the menu  then click System Administration.

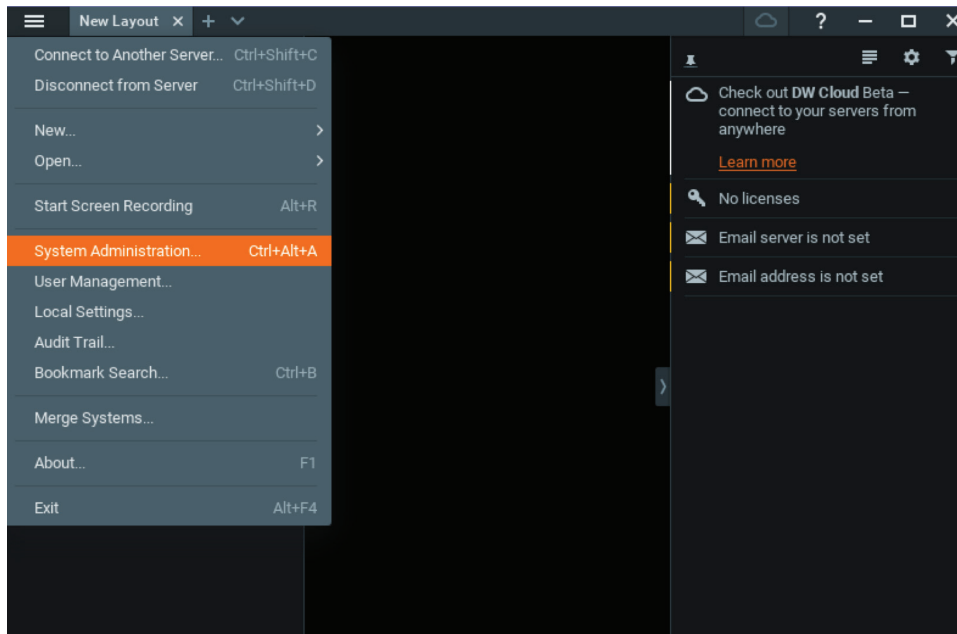

2. Go to Updates tab. Click Update System if turned orange.

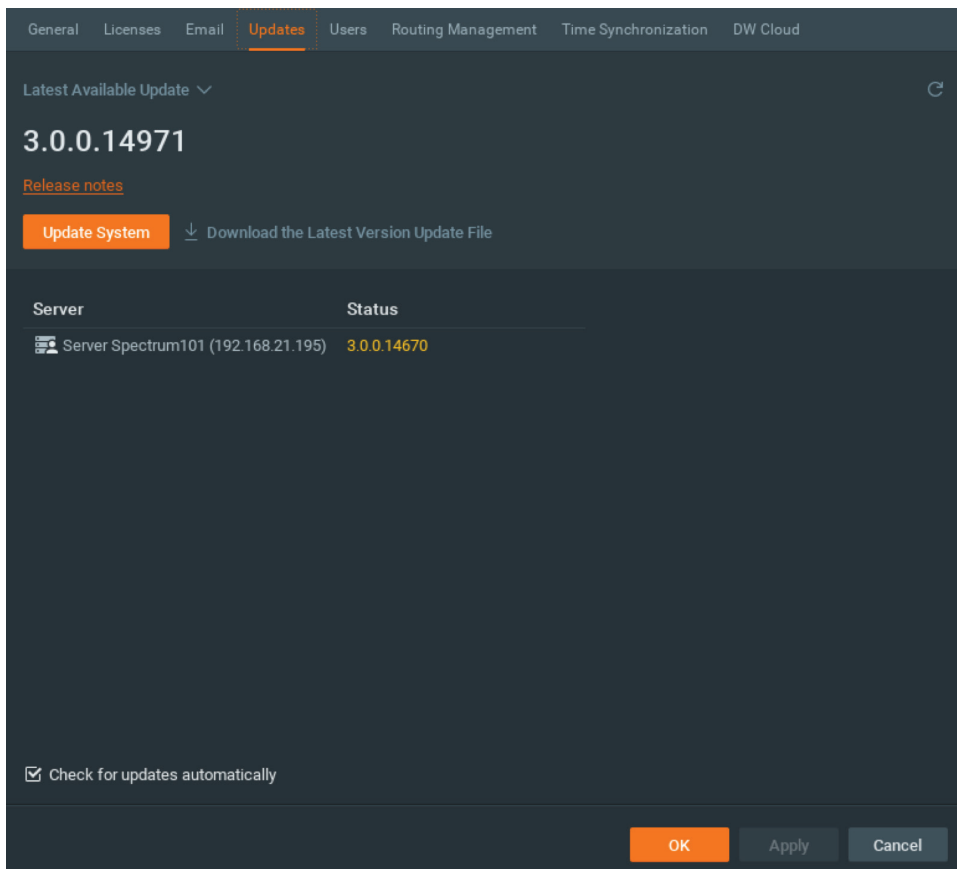

\* If you are on the latest version, it will say "You have the latest version installed" and the Update System button will be greyed out.

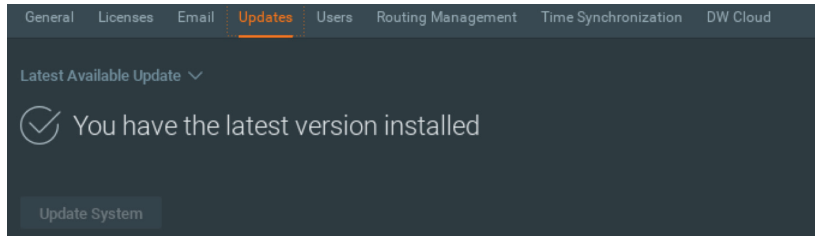

3. Click OK when update is completed.

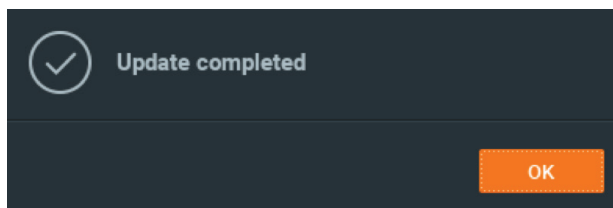

## STEP 4: Enter License

1. Go to System Administration then click License tab.
2. Enter License Key then click Activate License button. (Internet connection required)
  - \* Click on Activate Trial License if you have not purchased the valid license.

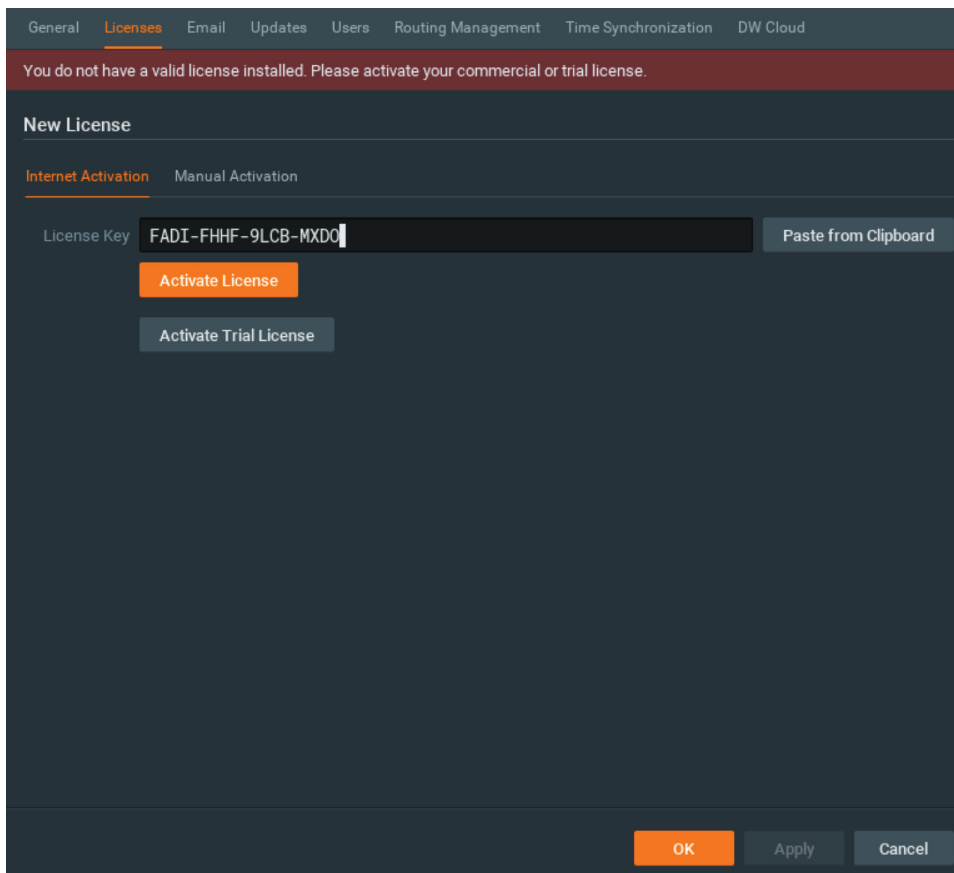

3. Click OK to when the License is activated.

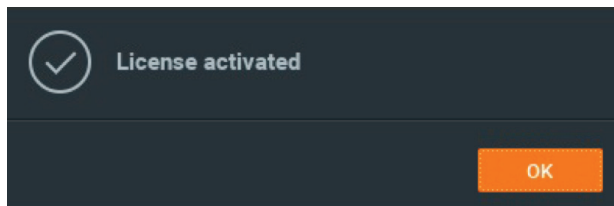

## STEP 5: Configure recording

1. Right click on the camera to setup recording, then click Camera Settings.

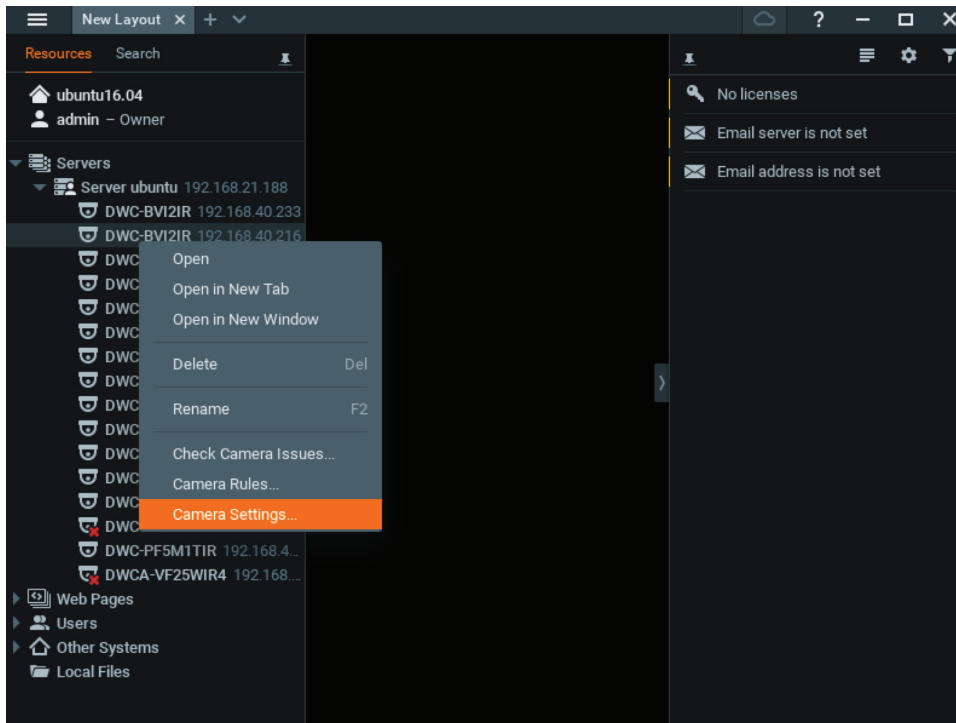



2. Go to Recordings tab.

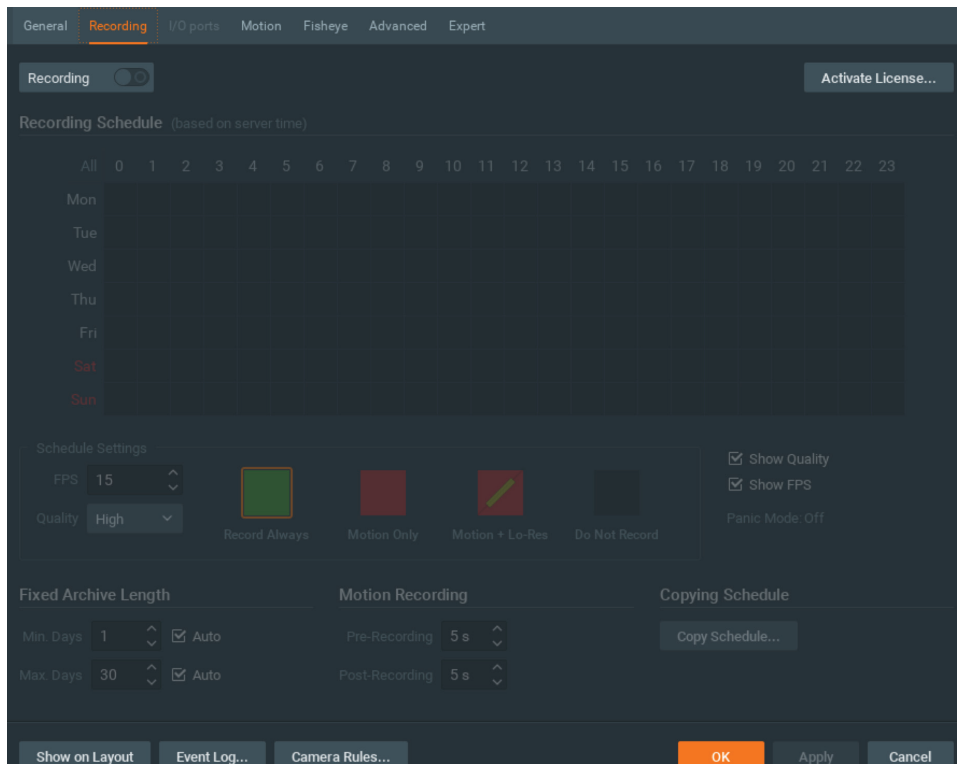

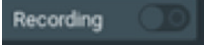
3. Click  to turn on recording.
4. Configure Schedule Settings for Quality, FPS and Recording Type.
5. Click and drag mouse over the Recording Schedule to assign the recording setting.

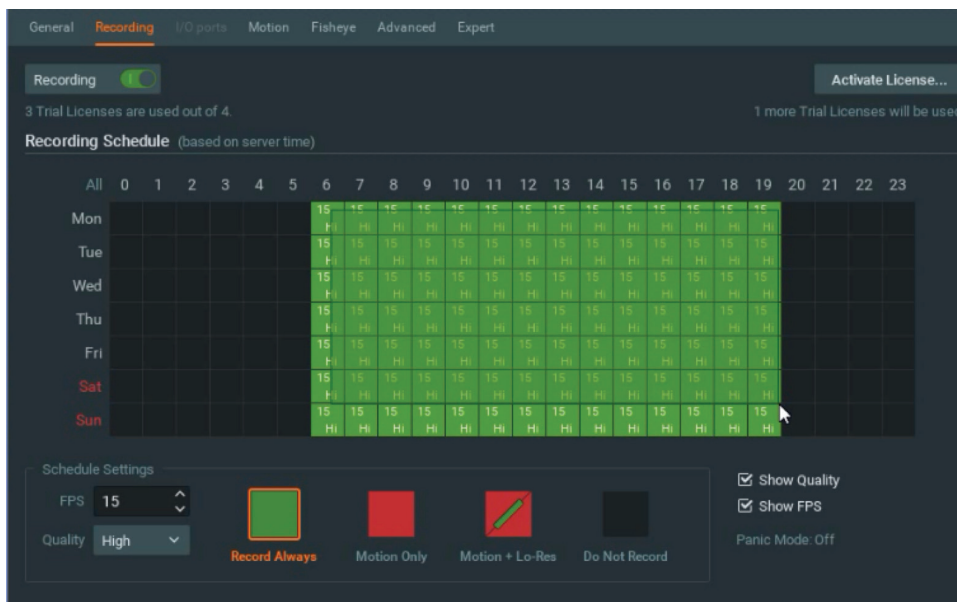

\* Click on All to apply to the all schedules.

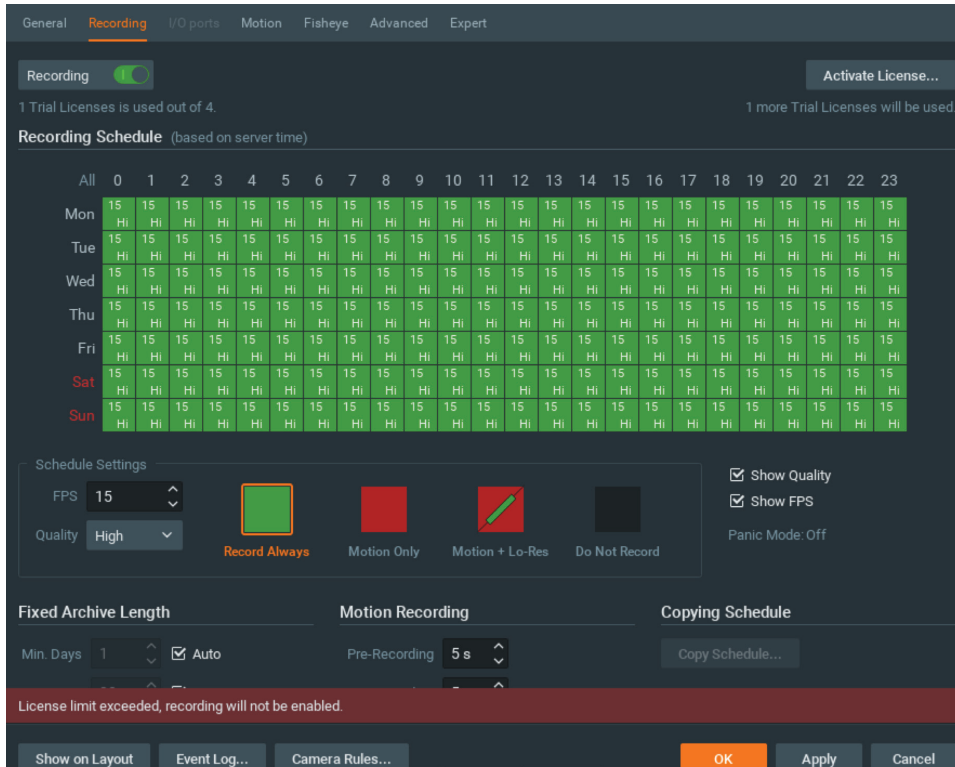
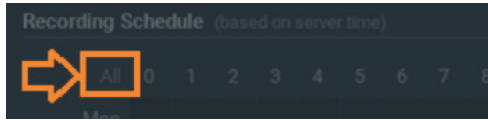

6. Red dot will appear next to the camera when the recording is started.

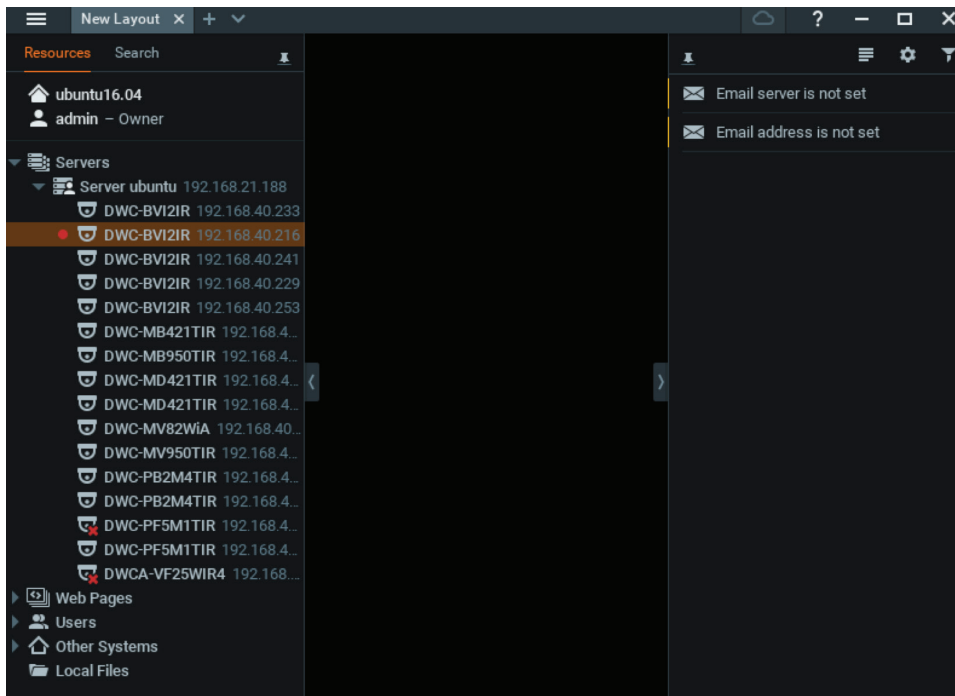

## STEP 6: Backuping Database

1. Go to System Administration and click General tab.

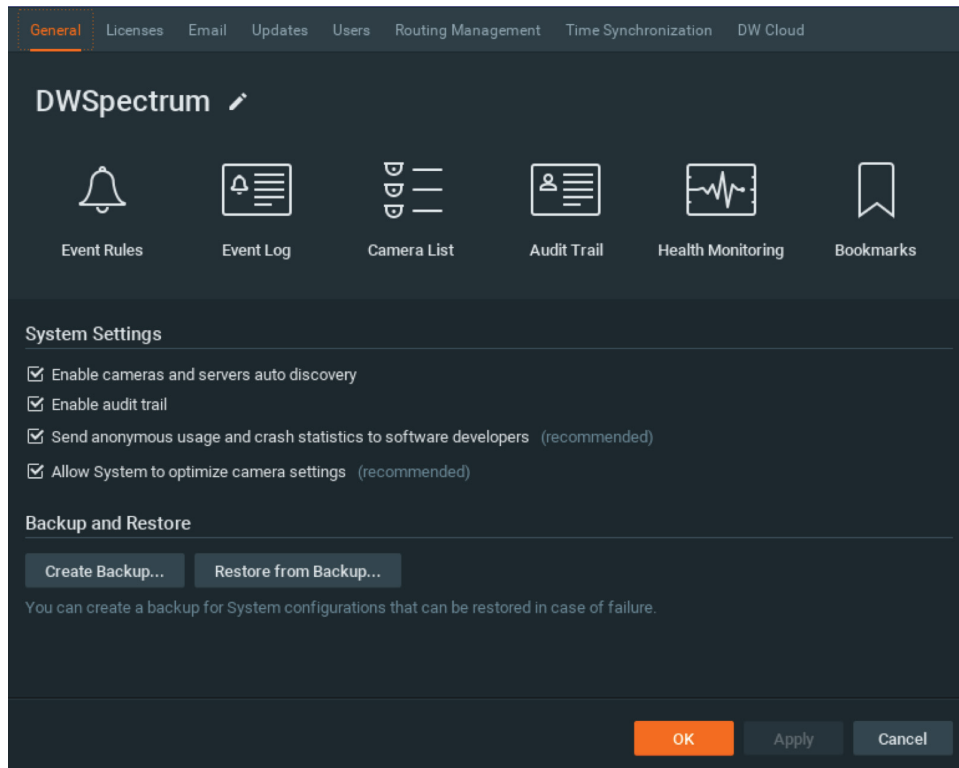

2. Click Create Backup... button.
3. Navigate to the folder where to save and enter name of the backup file then click save.
  - \* Strongly recommend to also backup to the external storage media.

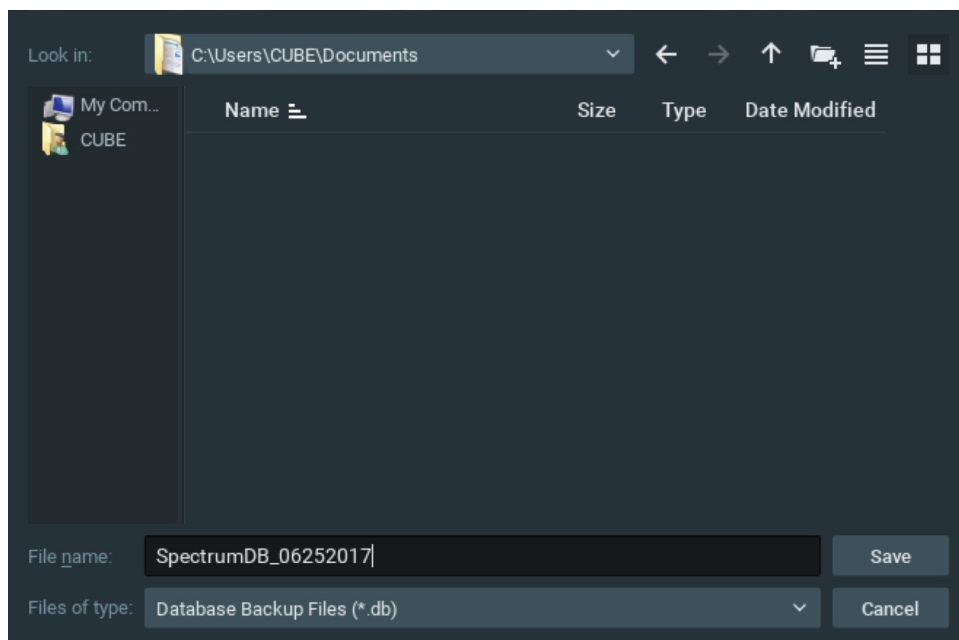



**NOTE:** More information and instructions are available in the Spectrum 3.0 Manual.

# TROUBLESHOOTING TIPS

Problem	Possible Solutions
My camera does not auto-discover	<ol style="list-style-type: none"> <li>1. Is the camera in the same LAN network as the Media Server?</li> <li>2. Is your camera compatible with DW Spectrum? (Refer to our website for full list of supported cameras.)</li> <li>3. Is the camera updated to its latest firmware?</li> <li>4. If your camera is integrated with DW Spectrum via ONVIF, make sure ONVIF is enabled on your camera.</li> <li>5. Try adding the camera manually.</li> <li>6. Try rebooting the server after installation. Allow up to 2 minutes for the server to map your network and detect all supported devices.</li> </ol>
Videos are slow	<ol style="list-style-type: none"> <li>1. Are you accessing the same cameras from multiple clients? (LAN &amp; WAN)</li> <li>2. Do you have a Gigabit network? Check your network speed.</li> </ol>
My camera appears disconnected	<ol style="list-style-type: none"> <li>1. Under camera settings, make sure the user name and password are correct.</li> <li>2. Under the camera settings, use the 'Ping' button to make sure the camera is connected to the network properly.</li> <li>3. If you can connect to the camera's web viewer, try rebooting the camera and/or restore it to factory default.</li> <li>4. Make sure your camera is using the latest firmware available.</li> <li>5. Make sure that the camera is connected to the same network as the server.</li> <li>6. If you are connecting to a camera that is integrated with DW Spectrum via the ONVIF protocol (see list), make sure ONVIF is enabled.</li> <li>7. Make sure your user has permissions to view that specific camera.</li> </ol>
I can't get playback video from my camera	<ol style="list-style-type: none"> <li>1. Do you have network connection between client and server (in case server and client are not on the same machine)?</li> <li>2. Make sure your user has playback viewing permissions for the selected channel.</li> <li>3. Make sure the camera is set to a recording mode that would provide recorded video for the selected time and environment.</li> <li>4. On the server side, check the media server log to make sure the camera you are trying to watch has not been unexpectedly disconnected.</li> </ol>
I get an 'unauthorized' message on my camera	<ol style="list-style-type: none"> <li>1. Make sure the camera's user name and password are properly entered in the camera's general information under the camera settings menu.</li> <li>2. If necessary, try rebooting the camera to apply the camera's user name and password.</li> </ol>

# SYSTEM REQUIREMENTS

## Recommended Specs for the Full Client

 Windows	Processor	Intel Core i5 or greater	
	Video Card	Intel HD Graphics 2500 (or higher) with 1GB Dedicated Memory Recommend NVIDIA or AMD graphics card with 2GB or more memory	
	Resolution	1920 x 1080	
	RAM	16GB	
	NIC	1Gbps Ethernet	
 Linux OS	OS Supported - Client	Windows	7 Home, 7 Standard, 7 Pro, 7 Ultimate, 8/8.1 Standard, 8/8.1 Pro, 8.1 Enterprise, 10 Home/Pro/Enterprise**
		Windows Servers*	Any versions of 2008, any versions of 2008 R2, any versions of Server 2012, any versions of Server 2012 R2
		Linux	Ubuntu 14.04, Ubuntu 16.04
		Mac	OSX 10.11, OSX 10.12

\* Except Storage Server version

**Important:** OS not listed will be not be supported by DW® Tech Support

Tel: +1 (866) 446-3595  
Fax: (813) 888-9262



www.digital-watchdog.com  
sales@dwcc.tv