



DWC-MT94WiAT



Default Login Information	
Username: admin	Password: admin

WHAT'S IN THE BOX

Quick setup and Installation guides		1 set	Tapping Screws - 3pcs		1 set
Mounting Template		1	Plastic Plugs - 3pcs		1 set
Waterproof Cap		1 set	Rubber Plug		1
Hexagonal Wrench		1			

NOTE: Download all your support materials and tools in one place

- Go to: <http://www.digital-watchdog.com/resources>
- Search your product by entering the part number in the 'Search by Product' search bar. Results for applicable part numbers will populate automatically based on the part number you enter.
- Click 'Search'. All supported materials, including manuals and quick start guide (QSGs) will appear in the results.



Attention: This document is intended to serve as a quick reference for initial set-up. It is recommended that the user read the entire instruction manual for complete and proper installation and usage.

STEP 1 - PREPARING TO MOUNT THE CAMERA

1. The mounting surface must bear five times the weight of your camera.
2. Do not let the cables get caught in improper places or the electric line cover to be damaged. This may cause a breakdown or fire.
3. Using the mounting template sheet or the camera itself, mark and drill the necessary holes in the wall or ceiling.

STEP 2 - POWERING THE CAMERA

Pass the wires through and make all the necessary connections. See STEP 4.

1. NETWORK CONNECTIONS - Using a PoE Switch or PoE Injector, connect the camera using an Ethernet cable for both data and power.
2. NETWORK CONNECTIONS - Not using PoE Switch or PoE Injector, connect the camera to the switch using an Ethernet cable for data transmission and use a power adapter to power the camera.

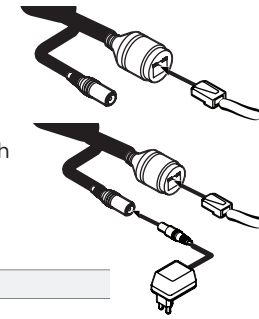

Power requirements	Power consumption
DC12V, PoE (IEEE 802.3af class 3). Adapter not Included.	<9.5W

STEP 3 - INSTALLING THE CAMERA

1. Mount the camera to the mounting surface using the included screws and anchors.
2. To use the camera's waterproof wiring:
 - a. Install the LAN cable into **a**.
 - b. **b** will be assembled to **a** with a 1/4 turn.
 - c. Thread **c** tightly to **b**.
3. Loosen the lock screw under the camera's lens to adjust the camera module's position.

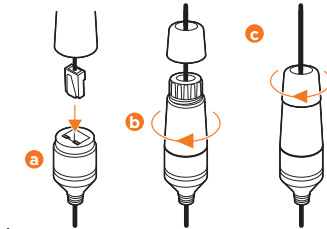

Resetting the camera: To reset the camera, use the tip of a paper clip or a pencil and press the reset button. Loosen the lock screw under the camera's lens and rotate the camera module to access the control panel. Open the control panel cover on the top of the camera module to access the control panel. Pressing the button for five (5) seconds will initiate a camera-wide reset of all the settings, including network settings.

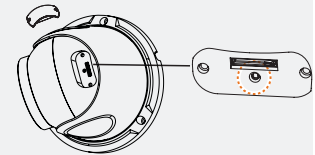
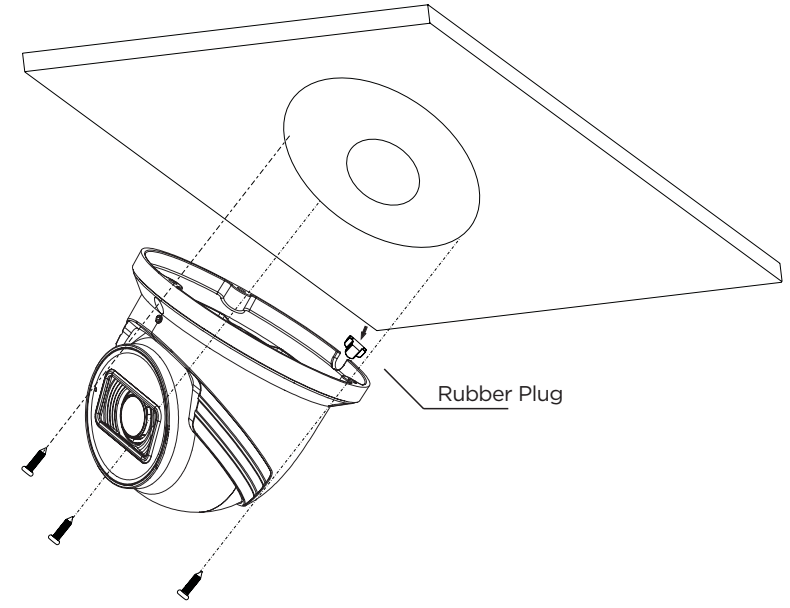
STEP 4 - CABLING

Use the diagram below to properly connect power, network and audio to the camera.

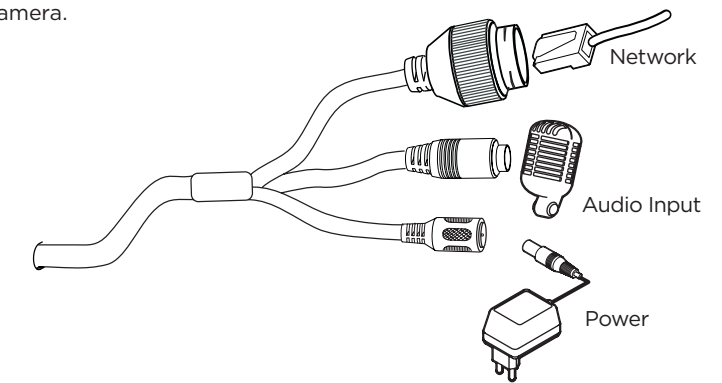

STEP 5 - MANAGING THE SD CARD

1. To install the camera's SD Card, loosen the lock screw under the camera lens and rotate the camera module to access the control panel. Open the control panel cover on the top of the camera module. Locate the SD card slot by opening the control panel at the base of the camera module.
2. Insert a class 10 SD/SDHC/SDXC card into the SD card slot by pressing the SD card until it clicks.
3. To remove the SD card, press the card inward until it clicks to release it from the card slot.

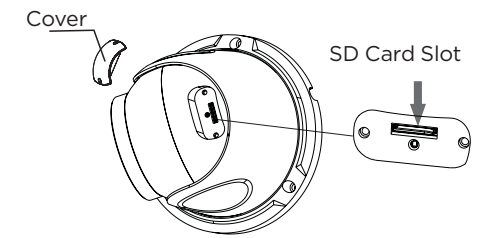

STEP 6 – DW® IP FINDER™

Use the DW® IP Finder™ software to scan the network and detect all MEGApix® cameras, set the camera's network settings or access the camera's web client.

Thumbnail view

Select network to scan

Filter device type to scan

Scan devices

Show/hide thumbnail view

Refresh thumbnail view

Bulk IP assignment

Firmware upgrade

Firmware version

Camera's uptime

Open Device configuration settings

Device's information

Name	IP Address	Model	MAC Address	Netmask	Gateway	Port	DHCP	Version	Ping Test	IP Conf.	Uptime
DWC-MP2Z30X	192.168.150.34	DWC-MP 2Z30X	00:07:08:19:10:1A	255.255.255.0	192.168.150.1	80	Disabled	1.9.94-X2_release	Ping	Click	--
DWC-MV44WA	192.168.150.40	DWC-MV 44WA	00:00:F1:21:53:8F	255.255.255.0	192.168.150.1	80	Disabled	A2.01.02_20180619	Ping	Click	28day 14hrs 1mins
DWC-PZ21M69T	192.168.150.41	DWC-PZ21M69T	00:00:F1:21:29:21	255.255.255.0	192.168.150.1	80	Disabled	A5.01.03_20180403	Ping	Click	39day 15hrs 54mins
DWC-PVX16W4	192.168.150.42	DWC-PV 16W4	00:00:F1:21:5C:AD	255.255.255.0	192.168.150.1	80	Disabled	S2.01.03_20180309	Ping	Click	56day 16hrs 46mins
DWC-PFSM1TR	192.168.150.61	DWC-PFSM1TR	00:0A:61:1A:00:14	255.255.255.0	192.168.150.1	80	Disabled	-	Ping	Click	--
DWC-PVF9M2TR	192.168.150.62	DWC-PVF9M2TR	00:0A:61:1A:26:E7	255.255.255.0	192.168.150.1	80	Disabled	-	Ping	Click	--
DWC-MF4WH	192.168.150.63	DWC-MF4WH	00:00:F1:20:F8:60	255.255.255.0	192.168.150.1	80	Disabled	A2.01.02_20180619	Ping	Click	28day 14hrs 0mins

STEP 7 – WEB VIEWER

NOTE: This camera's web client is available via Internet Explorer® only.

The GUI display may differ by camera models.

Once the camera's network settings have been setup properly, you can access the camera's web viewer.

To open the camera using the DW IP Finder:

1. Find the camera using the DW IP Finder.
2. Double-click on the camera's view in the results table.
3. Press the 'View Camera Website'. The camera's web viewer will open up in your default web browser.
4. Enter the camera's username and password.

To open the camera using the web browser:

1. Open a web browser (Internet Explorer® 8.0 or above).
2. Enter the camera's IP address and port in the address bar.
Example: `http://<ipaddress>:<port>`.
Port forwarding may be necessary to access the camera from a different network. Contact your network administrator for more information.
3. Enter the camera's username and password (default admin/admin).

If you are accessing the camera for the first time, install the ActiveX player for web files to view video from the camera.

NOTE: Some menu options may not be available based on the camera model. See the full manual for more information.

Network Setup

1. To install the DW IP Finder, go to <http://www.digital-watchdog.com>
2. Enter "DW IP Finder" on the search box at the top of the page.
3. Go to the "Software" tab on the DW IP Finder page to download the installation file.
4. Follow the installation to install the DW IP Finder. Open the DW IP Finder and click 'Scan Devices'. It will scan the selected network for all supported devices and list the results in the table. During the scan, the DW® logo will turn gray.
5. When connecting to the camera for the first time, a password must be set. To set up a password for your new camera:

- i** Select DHCP to allow the camera to receive its IP address automatically from the DHCP server.
- i** Select "Static" to manually enter the camera's IP address, (Sub) Netmask, Gateway and DNS information.
* The camera's IP must be set to Static if connecting to Spectrum® IPVMS.
- i** Contact your network administrator for more information.

i Default TCP/IP information: DHCP

- a. Check the box next to your new camera from the IP Finder's search results. You can select multiple cameras.
 - b. Click "Bulk Password Assign" on the left.
 - c. In the pop-up window, enter admin/ admin in the current username and password fields. Enter a new username and password to the right.
 - d. Press "change" to apply all changes.
6. Select a camera from the list by double-clicking on the camera's image or clicking on the 'Click' button under the IP Conf. column. The pop-up window will show the camera's current network settings, allowing admin users to adjust the settings as needed.
 7. To access the camera's web page, go to the IP Config page and click on the 'View Camera Website'.
 8. To save the changes made to the camera's setting, input the username and password of the camera and click Apply.

i 'Port forwarding' has to be set in your network's router for external access to the camera.