

  
**DynaLock™**  
*For Life™*

# PRODUCT CATALOG



[WWW.DYNALOCK.COM](http://WWW.DYNALOCK.COM)

Effective April 1, 2020

# Table of Contents



<b>Lifetime Warranty</b> .....	3
<b>Terms and Conditions</b> .....	4
<b>Electromechanical Locks &amp; Hardware</b>	
1300 Series Electric Deadbolt .....	5
1400 Series Dual Voltage Cabinet Locks .....	5
1600 Series Electric Strikes-Standard .....	6
1900 Series All-In-One Electric Strikes .....	7
ECL-1 Electrified Cylindrical Lock .....	8
EML Series Electrified Mortise Locks .....	9
ETH-1/ETM-1 Series Transfer Hinges .....	10
EMK-VON Motorized Latch Pullback Kit .....	11
<b>Electromagnetic Locks</b>	
Electromagnetic Lock Family .....	12
Typical Installations .....	13
2000 Series 1200 Lbs. HF .....	14
2013 Series, 2513 Series Gate Locks .....	15
2050 Series 1200 Lbs. HF .....	16
2101 Series Early Warning 1200 Lbs. HF .....	17
2511 Series Early Warning 650 Lbs. HF .....	17
2268 Series Low Profile 1200 Lbs. HF .....	18
2600 Series Mortise 650 Lbs. HF .....	18
2280 Series Slimline 1200 Lbs. HF .....	19
2500 Series Mini-Mag 650 Lbs. HF .....	20
2585 Series Bantam 650 Lbs. HF .....	20
2800 Series Door Holders .....	21
3000 Series 1500 Lbs. HF .....	23
Custom Length Housings .....	24
3006 Series Free Egress Lock .....	25
3101C Series Delay Egress 1500 Lbs. HF .....	26
3101C-TJ101 Inswing Delay Egress Lock .....	26
3101C-ES Series Delay Egress Controller .....	27
3101C-R Series Delay Egress Controller .....	27
TJ Conversion Kits .....	28
<b>Mounting Accessories</b>	
Specialty Brackets and Hardware .....	28
4000 Series Fillers, Spacers & Angle Brackets ...	29-30
<b>Power Supplies</b>	
5725 Series 1.5 Amp .....	31
5800/5850 Series 3 Amp .....	32
5900/5950 Series 6 Amp .....	33
5200/5300 Series Transformers .....	34
5400 Series Battery Back-Up .....	34

<b>Access/Egress Controls</b>	
6000 Series Pushbuttons .....	35
6200 Series Pushbuttons .....	36-37
6170 Series Weatherproof Pushbuttons .....	38
6300 Series Audible .....	37
6335/6336 Concealed Pushbuttons .....	44
6350 4 Zone Delay Egress Monitor .....	44
6370 Monitor/Reset Station .....	44
6420 Series PIR REX Sensor .....	45
6451 Series Exit Sensor Bar .....	46
6500 Series High Visibility Pushplates .....	39
6600 Series Halo Lighted Push Buttons.....	40
6700/6800 Series Pushplates .....	41
6705/6805 Series Handicapped Pushplates.....	42
6901 Series Specialty Pushplates .....	43
7000 Series Keyswitches .....	47
7075 Series Break Glass Exit Stations .....	48
7300/7400 Series Digital Keypads .....	49
7500 Stand Alone Pin & Proximity Controller.....	50
8000 Series Consoles .....	51-53
8500 Communicating Bathroom Systems .....	54

<b>Time Controllers</b>	
7080 Series Time Delay Module .....	48
7086 Series Programmable Timer .....	48

<b>Accessories</b>	
7088 Rectifiers - Prewired .....	48
9200 Series Door Status Switches .....	55
9300 Series Door Cords .....	55

<b>Product Approvals</b> .....	22
--------------------------------	----

<b>Wire Size Selection Chart</b> .....	34
--	----

<b>Special Finishes</b> .....	56
-------------------------------	----

<b>Reference Section</b> .....	57
--------------------------------	----

<b>Website Referral</b> .....	58
-------------------------------	----

<b>Recently Discontinued Products</b> .....	59
---	----



Except where specifically stated, a lifetime warranty applies to all standard DynaLock Corporation products.

A customer may return any DynaLock branded product, for any reason, at any time, by requesting a DynaLock Return Authorization (RMA). At RMA issuance, DynaLock Technical Support may contact the customer, in an effort to diagnose and resolve a product issue, without necessitating a return. Should the RMA proceed, DynaLock will make its best effort to, within 24 hours of receipt of the customer's item (excluding special finishes and custom products), send a replacement product, via next day freight, at no-charge.

A customer may order an advance replacement product, if they have an open account with DynaLock, or valid credit card. DynaLock will issue an RMA and bill the customer up-front, for the full price of the replacement, plus next day freight. Upon receipt of the customer's original product, DynaLock will credit the advance replacement order in-full, including the outbound freight. Inbound freight and insurance charges are exclusively the customer's responsibility.

DynaLock Corporation reserves the sole right to send a replacement product, which may be identical, or a newer product, which serves as a direct, functional replacement. In the event the customer's original product has become obsolete in DynaLock's product line, or has been intentionally damaged, abused and/or vandalized this DynaLife<sup>®</sup> PLUS warranty shall not apply.

This DynaLife<sup>®</sup> PLUS warranty does not apply to non-standard, custom-built products. These products will be repaired, if possible, at no-charge. Custom length housings and special finished products will be replaced only if found to be factory-defective.

This DynaLife<sup>®</sup> PLUS warranty also does not apply to returns for payment, distributor stock reductions/liquidations, product removal and installation/re-installation costs, or products installed outside of the United States and Canada.

This DynaLife<sup>®</sup> PLUS warranty shall be considered null and void on any product which has been electrically or mechanically altered, without specific written consent, instructions and/or component parts supplied by DynaLock Corp.

DynaLock Corporation will assume no responsibility, nor be liable to the customer, purchaser, or anyone else, for incidental or consequential damages arising from defects, or malfunctions of its products, damage or injury to person(s) or property, caused by improper storage, handling, care, maintenance, abuse, misuse, or an act of God. EXCEPT FOR THE WARRANTY PROVIDED HEREIN, WE EXPRESSLY DISCLAIM ALL WARRANTIES, EXPRESS OR IMPLIED, INCLUDED BUT NOT LIMITED TO ANY IMPLIED WARRANTIES, OF MERCHANTABILITY OR FITNESS FOR A PARTICULAR PURPOSE, OR WARRANTIES RELATING TO THE CONDITION OF OUR PRODUCTS.

## Emergency Technical Support

Routine technical support is available Monday - Friday, 8:00AM - 5:00PM (EST) by calling the factory toll-free at 1-877-DynaLock.

**Emergency technical support** is available Monday - Friday, 5:00PM - 8:00PM (EST) by dialing any of the following:

(860) 637-2599 / (860) 916-4805 / (860) 878-9085

# Terms and Conditions



<b>Terms:</b>	NET 30 days from date of invoice. No minimum order requirements and no additional surcharges imposed for drop shipments. A late charge of 1.5% per month on any balance which remains unpaid after 60 days from date of invoice.
<b>Prices:</b>	Unless firm prices have been quoted in writing for specific projects, all prices are subject to change and prices in effect on the date of shipment will apply. Prices apply to standard domestic packaging. Errors and omissions in pricing are subject to correction.
<b>Domestic Shipments:</b>	All domestic shipments are F.O.B. DynaLock factory, unless otherwise agreed to in writing by DynaLock. Purchaser assumes risk of loss upon tender of goods to carrier.
<b>International Shipments:</b>	International shipments will only be made to those customers who utilize a carrier and/or freight forwarder with whom they maintain a direct-billing account. Following acceptance of the customer's order, upon request DynaLock will inform the customer of the weight(s) and dimension(s) of the shipment. It is the customer's responsibility to inform DynaLock of the carrier/forwarder they wish to utilize for the shipment, by whom they will be direct-billed for the international shipping charges.
<b>Routing, Receipt &amp; Order Acceptance:</b>	Electronically-transmitted customer orders must be routed via fax (860-585-0338) or via e-mail (orders@dynalock.com), and are subject to final acceptance by the DynaLock Customer Service/Order Entry Department. Accepted orders are normally acknowledged within 24 hours. It's the purchaser's responsibility to confirm successful electronic transmission and receipt of their orders by DynaLock Corp. and verify the accuracy of the order acknowledgment. DynaLock assumes no liability for lost or incorrectly routed, electronically-transmitted orders.
<b>ACH &amp; Wire Transfer Service Fees:</b>	Service fees will apply to all orders where customer payment is made by ACH or Wire Transfer. For more information on specific fees, please contact the DynaLock Customer Service Department.
<b>Claim and Notice of Non-Conformity:</b>	Goods must be inspected promptly. Claims relating to nonconformity of goods or shipments must be reported within (10) business days following receipt of goods. All notices and claims must include Purchaser's order number and DynaLock's invoice number. Unless written notice of a claim of nonconformity is given within such 10-day period, the claim may be disregarded. DynaLock's liability for any nonconformity in goods or shipment is expressly limited to replacement of the goods or goods of equal value, together with transportation charges, if any, incurred by Purchaser. PURCHASER SHALL NOT BE ENTITLED TO CLAIM CONSEQUENTIAL DAMAGES FOR ANY NONCONFORMITY OR DEFECT IN THE GOODS.
<b>Cancellation Charges:</b>	Purchase orders and/or items cancelled more than 48 hours after factory acknowledgement are subject to a <b>35% cancellation charge</b> .
<b>Product Changes:</b>	DynaLock continuously endeavors to improve and update its products. It reserves the right to discontinue models and/or features, change design specifications, materials, components, manufacturing processes, etc., at any time, without prior notice and without incurring any obligations for products/models manufactured prior to any changes.
<b>Returns:</b>	Returns will not be accepted without prior approval and a RMA number (Return Authorization) issued by DynaLock's Customer Service Department. Products returned for credit are subject to a <b>restocking charge of 35%</b> . Additional charges may be imposed if return is damaged. Purchaser must provide invoice number and information regarding original date of shipment with all returned goods. Any credit issued must be applied to open or future invoices. <b>Cash refunds will not be issued.</b> Credits not redeemed within one calendar year of issuance will be written-off. Acceptance of products returned for credit, which are more than one year-old, will be solely at DynaLock's discretion. Custom products, e.g. consoles, custom length housings, special finished products cannot be returned for credit. Electrically or mechanically altering any product(s) without specific written consent, instructions and/or component parts supplied by DynaLock Corp. voids the DynaLife® PLUS Lifetime Warranty and renders such returned product(s) ineligible for credit.
<b>Engineering Charges:</b>	Engineering charges will be discussed, negotiated and estimated prior to any actual engineering services being performed. DynaLock will not be responsible or bound for estimates or preliminary discussions by telephone. Firm estimates will only be given after submittal of specifications, drawings and theory of operation.
<b>Taxes:</b>	Purchaser is responsible for all taxes or charges in lieu of taxes now or hereafter imposed on the sale or transportation of goods purchased, except for income or similar taxes imposed on DynaLock.
<b>Governing Law:</b>	The rights and obligations of DynaLock and Purchaser shall be governed by and construed in accordance with the laws of the State of Connecticut.
<b>No Modification:</b>	These terms and conditions of sale cannot be modified or amended without DynaLock's consent. DynaLock shall not be bound by the terms or conditions of any purchase order, order acknowledgment or other form submitted by Purchaser unless DynaLock has consented in writing to such terms.
<b>Electromagnetic Lock Performance:</b>	DynaLock electromagnetic lock holding force ratings are stated at peak performance ( $\pm 10\%$ ), under proper mounting and optimum input power conditions.
<b>Cost and Expenses:</b>	In the event DynaLock incurs any expenses in connection with the enforcement of the Purchaser's obligations under this order, DynaLock shall be entitled to collect such costs, including reasonable attorney's fees from the Purchaser in connection therewith.

## 1300 Series Mortise Electric Deadbolt



1300 x ARSB

Mortise Mounted Narrow Design  
 \*Fail Safe Electric Deadbolt Lock  
**Dual-Voltage 12/24 VAC/VDC Input Standard.**

Size: 1-1/2"W x 8"H x 1-5/8"D Backset  
 Current Draw: 850 mA @ 12 VDC/VAC  
 450 mA @ 24 VDC/VAC

\*Fail Safe operation indicates power required to lock. Interruption of power allows bolt to retract. Not suitable for use on wood door and frame installations or doors equipped with panic devices. Never use on doors designated for or in a path of egress.

MODEL	PRODUCT	FINISH	WEIGHT
1300	Mortise Electric Deadbolt - 12 VAC/VDC	US28	1.8 Lbs.

### OPTIONS

- ARSB** Auto-Relock Switch - Ball Type
- ARSM** Auto-Relock Switch - Concealed Type
- BPS** Bolt Position Switch
- DPSB** Door Position Switch - Ball Type
- DPSM** Door Position Switch - Concealed Type
- **MB** Mounting Brackets (4 Pieces)
  - NOTE: Required when retro-fitting into existing frame.



1410



1420

## 1400 Series Dual Voltage Cabinet Locks

Surface-Mounted Compact Design  
 Selectable Fail-Safe or Fail-Secure Operation  
 12/24 VDC Field-Selectable Dual Voltage  
 440Lbs Holding Force  
 Compatible for Top or Side Mount Applications

1410 Dimensions: 1-1/4"D x 1-3/16"W x 2-7/8"H  
 1420 Dimensions: 1-1/4"D x 1-3/16"W x 3-11/16"L  
 Current Draw: 200 mA @ 12 VDC  
 100 mA @ 24 VDC

**Dual SPDT Monitoring Outputs Available (Model #1420 Only)**

MODEL	PRODUCT	FINISH	WEIGHT
1410	Dual Voltage Cabinet Lock	US19	.4 Lbs.
1420	Dual Voltage Cabinet Lock (Dual Output)	US19	.8 Lbs.



## 1600 Series Electric Strikes

DynaLock 1600 Series Electric Strikes are universally adaptable to suit all door and frame types and accommodate most locking devices with up to a 3/4" latch projection. To simplify ordering and speed installation all 1600 Series models feature 12/24V AC/DC field-selectable operation, dial-selectable fail-safe or fail-secure operating mode, 1/4" horizontal adjustment and modular, plug-in wire connections. All models are also available in a low-profile, 1-1/16" backset version, for narrow-style aluminum frames, which accept up to a 5/8" latch projection. Optional latch/keeper monitor switches are also available.

Current Draw: 375 mA @ 12VDC; 565 mA @ 12VAC  
 190 mA @ 24VDC; 280 mA @ 24VAC

MODEL	PRODUCT	FINISH	WEIGHT
<b>1604S</b>	Aluminum/Wood Frames, Std. Profile, 1-1/4" x 4-7/8"	US32D	1.5 Lbs.
<b>1604L</b>	Aluminum/Wood Frames, Low Profile, 1-1/4" x 4-7/8"	US32D	1.5 Lbs.
<b>1614S</b>	Steel/Wood Frames, Std. Profile, 1-1/4" x 4-7/8"	US32D	1.5 Lbs.
<b>1614L</b>	Steel/Wood Frames, Low Profile, 1-1/4" x 4-7/8"	US32D	1.5 Lbs.
<b>1605S</b>	Aluminum/Wood Frames, Std. Profile, 1-1/8" x 5-7/8"	US32D	1.6 Lbs.
<b>1605L</b>	Aluminum/Wood Frames, Low Profile, 1-1/8" x 5-7/8"	US32D	1.6 Lbs.
<b>1607S</b>	Aluminum/Wood Frames, Std. Profile, 1-1/4" x 6-7/8"	US32D	1.8 Lbs.
<b>1607L</b>	Aluminum/Wood Frames, Low Profile, 1-1/4" x 6-7/8"	US32D	1.8 Lbs.
<b>1608S</b>	Aluminum/Wood Frames, Std. Profile, 1-7/16" x 7-15/16"	US32D	2 Lbs.
<b>1608L</b>	Aluminum/Wood Frames, Low Profile, 1-7/16" x 7-15/16"	US32D	2 Lbs.

## 1900 Series All-in-One Electric Strikes



**1921**

Versatile DynaLock 1900 Series All-in-One fire-rated (UL 10C, 3 hour) and non-fire-rated Electric Strikes accommodate mortise and cylindrical locksets, as well as mortise exit devices, with offset, or centerline latch entry and up to a 3/4" latch projection. The adjustable deadbolt keeper and deadlatch ramp vertically align to accommodate a wide variety of mortise locks with offset latches. A unique, sliding shim design adjusts vertically on the keeper, to provide up-to 1/8" horizontal adjustment and a "plug-in" latch monitor switch option kit may be added in the field. Field-selectable input voltage 12/24 VDC or 12-24 VAC (1921). Both models fit a HES 1006 (1003) frame cutout (hollow-metal), with no additional modifications.

Current Draw: 375 mA @ 12VDC, Continuous (1921, 1923)  
 190 mA @ 24VDC, Continuous (1921, 1923)  
 280 - 565 mA @ 12-24VAC, Intermittent (1921 Only)

MODEL	PRODUCT	FINISH	WEIGHT
<b>1921</b>	Fire-Rated All-in-One Strike, Fail-Secure, 12/24 VAC/VDC	US32D	2.5 Lbs.
<b>1923</b>	Non Fire-Rated All-in-One Strike, Fail-Safe, 12/24 VDC	US32D	2.5 Lbs.

## 1900 SERIES OPTIONS

**19-LM** Latch Monitor Plug-In Kit, 1900 Series

### FEATURES:



### DIMENSIONS

ANSI 1-1/4" x 4-7/8" x 1-3/4"



1921 on cylindrical and mortise locks only

# Electrified Cylindrical Lockset



ECL-1



## ECL-1 Electrified Cylindrical Lockset

DynaLock ECL-1 Series is a UL Listed, ANSI/BHMA Grade 1 electrified cylindrical lock, featuring a clutching lever design and a Schlage C-type keyway standard. Available in either fail-safe (electrically-locked) or fail-secure (electrically-unlocked) operating configurations, the ECL-1 fits door thicknesses of from 1-9/16" to 2-1/8". The ECL-1 operates on 12-24 VAC/VDC input, is UL Listed for use on labeled fire doors rated up to 3 hours and includes standard bent lever trim.

Current Draw: 250mA @ 12 VDC; 150 mA @ 24 VDC

MODEL	PRODUCT	FINISH	WEIGHT
ECL-1	Electrified Cylindrical Lockset, Storeroom Function	626 (US26D)	5.0 Lbs.

## MODEL SELECTION

**ECL-1 - XX - XXX**  
(Model)

↓  
**Optional Finish**

- 613** Dark Bronze (US10B)<sup>1</sup>
- 625** Bright Chrome (US26)<sup>1</sup>
- 605** Bright Brass (US3)<sup>1</sup>

↓  
**Specify Locking Mode**

- EL** ELECTRICALLY-LOCKED (FAIL-SAFE)
- EU** ELECTRICALLY-UNLOCKED (FAIL-SECURE)

<sup>1</sup> Not stocked. Consult factory for availability & lead time.



# Electrified Mortise Locksets



EML-1



## EML Series Electrified Mortise Locksets

DynaLock EML Series electrified mortise locks are UL Listed, ANSI/BHMA Grade 1 and designed to retrofit the Schlage L9000 Series. EML Series locksets feature field-selectable fail-safe (EL) / fail secure (EU) locking mode and field-reversible handing. The EML Series operates on 12-24 VAC/VDC input, is UL Listed for use on labeled fire doors rated up to 3 hours and includes standard bent lever trim.

Current Draw: 700mA @ 12 VDC; 350 mA @ 24 VDC  
 Finish: 626 (US26D)  
 Weight: 7.0 Lbs.

MODEL	FUNCTION	OPERATIONAL DESCRIPTION
<b>EML-1</b>	Storeroom Function Fail-Safe (EL) Fail-Secure (EU)	Outside lever locked (EL) or unlocked (EU) electronically. Latchbolt retracted by key outside or lever inside. Applied power allows outside lever to retract latchbolt. Inside lever is always free for immediate egress.
<b>EML-2</b>	Institutional Function Fail-Safe (EL) Fail-Secure (EU)	Outside and inside levers simultaneously locked (EL) or unlocked (EU) electronically. Latchbolt retracted by key on either side. Applied power allows both levers to retract latch bolt.
<b>EML-3</b>	Classroom Function Fail-Safe (EL) Fail-Secure (EU)	Outside lever locked (EL) or unlocked (EU) electronically. Latchbolt retracted by lever on either side, unless outside has been locked by key. Applied power allows outside lever to retract latchbolt. Inside lever is always free for immediate egress.
<b>EML-4</b>	Privacy w/Deadbolt Fail-Secure (EU)	Outside lever unlocked (EU) electronically. Latchbolt and deadbolt retracted by key outside or lever inside. Applied power allows outside lever to retract latchbolt unless deadbolt is thrown. Inside lever is always free for immediate egress. Available in Fail-Secure (EU) function only.
<b>EML-5</b>	Entry w/Deadbolt Fail-Safe (EL) Fail-Secure (EU)	Outside lever locked (EL) or unlocked (EU) electronically. Latchbolt and deadbolt retracted by key outside or lever inside. Applied power allows outside lever to retract latchbolt and deadbolt. Inside lever is always free for immediate egress.

## MODEL SELECTION

### EML-1 - XX - XX - XXX - XXX

(Model)



#### Optional Finish

- 613** Dark Bronze (US10B)<sup>1, 4</sup>
- 625** Bright Chrome (US26)<sup>1, 4</sup>
- 605** Bright Brass (US3)<sup>1, 4</sup>

#### Optional Monitor Switches

- REX** Request to Exit
- LBM** Latchbolt Monitor<sup>1</sup>
- DPS** Door Position Sensor<sup>1</sup>
- DBM** Deadbolt Monitor <sup>1, 3</sup>

#### Optional Configuration

- CH** Chassis/Only (No Trim)

#### Specify Factory-Set Locking Mode

- EL** ELECTRICALLY-LOCKED (FAIL-SAFE)<sup>2</sup>
- EU** ELECTRICALLY-UNLOCKED (FAIL-SECURE)

<sup>1</sup> Not stocked. Consult factory for availability & lead time.

<sup>2</sup> EL (Fail-Safe) Locking Mode not available on EML-4.

<sup>3</sup> For EML-4 & EML-5 Models only.

<sup>4</sup> Not available with CH Option.

## ETH-1/ETM-1 Energy Transfer Hinges



ETH-1-4W



DynaLock ETH-1 Series Energy Transfer Hinges and ETM-1 Series Energy Transfer Monitor Hinges provide the ideal method of passing low voltage power from the hinge jamb to an electrified lockset or ELR exit device. They feature center-located wire access holes, non-conductive wire access caps and are UL Listed for use on fire doors. Both Series' may be ordered in either 2 or 4 wire configurations, with the ETM-1 additionally including a built-in SPDT monitor switch, for door position status reporting. All models are supplied as a 5-knuckle, standard-weight, 4.5" x 4.5" full-mortise hinge.

MODEL	PRODUCT	FINISH	WEIGHT
<b>ETH-1</b>	Energy Transfer Hinge	626 (US26D)	1.5 Lbs.
<b>ETM-1</b>	Energy Transfer Monitor Hinge	626 (US26D)	1.5 Lbs.

## MODEL SELECTION

**ETH-1 - XX - XXX**

(Model)

**Optional Finish\***

- 613** Dark Bronze (US10B)
- 625** Bright Chrome (US26)
- 605** Bright Brass (US3)

**Specify Wire Configuration**

- 2W** 2 Wires (20 Ga.) For Electric Locks, Exit Trim & Strikes
- 4W** 4 Wires (26 Ga.) For Electric Locks, Exit Trim & Strikes

\* Optional Finishes not stocked. Consult factory for availability and lead time.

## ELECTRICAL SPECIFICATIONS

Wire Configuration	Wire Qty.	Wire Gauge	Continuous Amps @ 24VDC	Surge/Pair (0.5 Sec) Amps @ 24VDC
2W	2	20	4.0A	16.0A
4W	4	26	1.0A	N/A

ETM-1 monitor switch contact rating: 100mA @ 30VDC

## EMK-VON Motorized Latch Pullback Kit



EMK-VON



The DynaLock EMK-VON is a field-installable motorized latch pullback kit for Von Duprin 33/35 and 98/99 series exit devices. Retrofit existing mechanical exit devices to electric latch retraction, while maintaining the UL Listing. The easy to install, robust kit comes equipped with "Push to Set" technology, to simplify post installation adjustments.

Features of the EMK-VON include:

- Smart module - Provides on-board diagnostics with audible feedback for adjustment and power issues.
- Push to Set - 5 second electronic adjustment, for easy post installation adjustments.
- Continuous-duty electric dogging - Auto retraction if dogged push pad is pulled from position.
- Low current draw - Compatible with most 24VDC, 1A (or greater) regulated power supplies.
- Field-switchable to "high-torque" mode.
- Up to 500' wire run with (2) 18 Ga. wires.
- 8' cable with quick-connect for smart module, to easily connect power supply leads.

Input Voltage Range: 22 to 28 VDC  
 Average Peak Current: 1.0A  
 Average Current Hold: 180mA

MODEL	PRODUCT	WEIGHT
EMK-VON	Motorized Latch Pullback Kit	2.0 Lbs.

## PREMIER LINE

**3000 SERIES** 1500 LBS. HF  
FAS-TRAK  
MOUNTING

### FEATURES:

- FULL LINE OPTIONS
- UPGRADABLE CIRCUIT BOARD
- FAS-TRAK MOUNTING
- ONE PIECE HOUSING
- NO VISIBLE MOUNTING SCREWS

**3006 SERIES** 1500 LBS. HF  
FREE EGRESS  
MAGLOCK

### FEATURES:

- FULL LINE OPTIONS
- BUILT-IN PIR REX SENSOR
- FAS-TRAK MOUNTING
- ONE PIECE HOUSING
- NO VISIBLE MOUNTING SCREWS

**3101C SERIES** 1500 LBS. HF  
DELAY EGRESS  
SYSTEM

### FEATURES:

- FULL LINE OPTIONS
- FAS-TRAK MOUNTING
- ONE PIECE HOUSING
- CODE COMPLIANT MODELS
- NOT AFFECTED BY DOOR IRREGULARITIES
- SELF CONTAINED SYSTEM
- WORKS WITH EXISTING DOOR HARDWARE

## STANDARD LINE

**2000 SERIES** 1200 LBS. HF  
CONVENTIONAL  
MOUNTING

### FEATURES:

- FULL LINE OPTIONS
- UPGRADABLE CIRCUIT BOARD
- ADJUSTABLE MOUNTING
- SEALED GATE LOCK MODEL
- LOW COST

## SLIM LINE

**2050 SERIES** 1200 LBS. HF  
LOW-PROFILE  
RETROFIT

### FEATURES:

- RETROFITS LSE 350+ SERIES
- FULL LINE OPTIONS

**2268 SERIES** 1200 LBS. HF  
"CLASSIC"  
LOW-PROFILE

### FEATURES:

- FULL LINE OPTIONS
- LOW 2" PROFILE
- RETROFITS LSE 268 SERIES

**2280 SERIES** 1200 LBS. HF  
"CLASSIC"  
LOW-PROFILE

### FEATURES:

- FULL LINE OPTIONS
- UPGRADABLE CIRCUIT BOARD
- ONE PIECE HOUSING

## MINI LINE

**2500 SERIES** 650 LBS. HF  
STANDARD  
MINI-MAG

### FEATURES:

- FULL LINE OPTIONS
- UPGRADABLE CIRCUIT BOARD
- LOW 1-3/4" PROFILE
- SEALED GATE LOCK MODEL
- LOW COST

**2585 SERIES** 650 LBS. HF  
"BANTAM"  
COMPACT LOCK

### FEATURES:

- SMALL 8-1/2" LENGTH
- LOW COST

**2600 SERIES** 650 LBS. HF  
SLIDING DOOR  
MORTISE LOCK

### FEATURES:

- NARROW 1-1/2" WIDTH
- OPTIONAL SLIDING DOOR MOUNTING HARDWARE

## OUTSWING DOORS

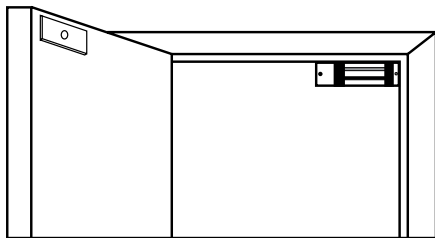

Single Lock

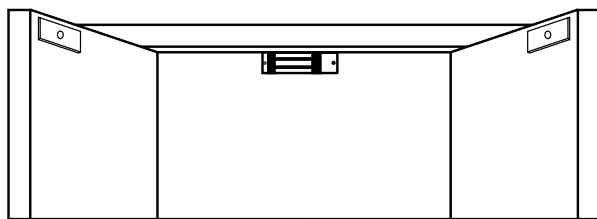

Single Lock Mounted On  
Double Door Without Center Mullion

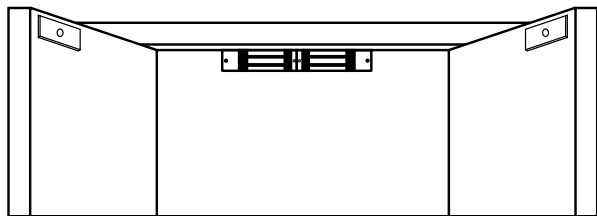

Double Lock Mounted On  
Double Door Without Center Mullion

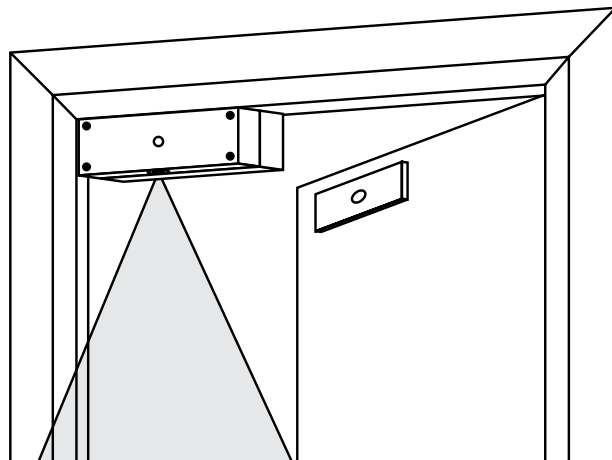

Single Lock With Built-in Adjustable PIR  
For Immediate Free Egress

3000 Series Electromagnetic Locks have the unique ability to change hand to match door handing. The wiring compartment may be located on the left or right hand side of the lock assembly, ideally toward the center of the opening. Handing may be specified at time of order or easily modified in the field.\*



**3000LHR**

**3000RHR**

*\* Field modifications will result in the misorientation of the DynaLock logo. Replacement access covers are available from the factory at no charge.*

## INSWING DOORS

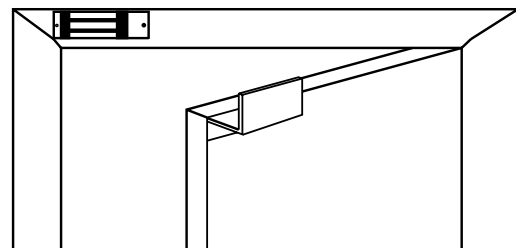

Single Lock, Inswing Door  
Mounted To Header Face  
With Adjustable Top Jam "Z" Bracket

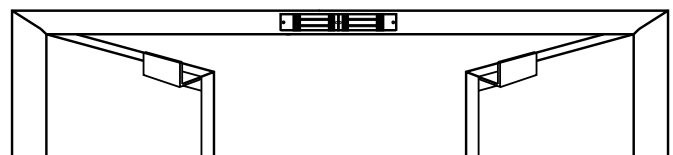

Double Lock, Inswing Door  
Center Mounted To Header Face With  
Adjustable Top Jamb "Z" Brackets

## 2000 Series 1200 Lb.



2011



2012



2011-390



2022



NYC MEA  
#23-92-E

CSFM

Electromagnetic locks, surface mounted for outswing or inswing single or double doors.

Size: 1-1/2"D x 2-3/4"H x 11"L Single or 22"L Double  
1-1/2"D x 2-3/4"H x 10-1/2" L (2011-390 only)

Multi-voltage auto-sensing 12/24 VAC/VDC

Current Draw: 374 mA @ 12VDC Single / 748 mA Double

210 mA @ 24VDC Single / 420mA Double

Adjustable Relock Time Delay (Former TD Option) is standard on all models.

MODEL	PRODUCT	FINISH	WEIGHT
<b>2011</b>	Single Electromagnetic Lock Outswing	US28	10 Lbs.
<b>2012</b>	Single Electromagnetic Lock Pair Outswing	US28	10 Lbs.
<b>2011-390</b>	Locknetics 390+ Exact Retro-fit	US28	10 Lbs.
<b>2022</b>	Double Electromagnetic Lock Outswing	US28	20 Lbs.
<b>2022-392</b>	Locknetics 392+ Exact Retro-fit	US28	20 Lbs.
<b>2011TJ20</b>	Single Electromagnetic Lock Inswing	US28	13 Lbs.
<b>2012TJ21</b>	Single Electromagnetic Lock Pair Inswing	US28	13 Lbs.
<b>2022TJ22</b>	Double Electromagnetic Lock Pair Inswing	US28	26 Lbs.

### OPTIONS

- **DSM** Door Status Switch - Signals door closed or ajar.
- **DSM2** Door Status Switch - For the 2022 Series.
- **HSM** High Security Monitor. Includes the following:  
Door Status Switch - Signals door closed or ajar.  
Dynastat Force Sensor - Indicates efficient magnetic bond.
- **HSM2** High Security Monitor - For the 2022 Series.
- **VOP** Value Option Package. Includes the following:  
Door Status Switch - Indicates door closed or ajar.  
Dynastat Force Sensor - Indicates efficient magnetic bond.  
Anti-Tamper Switch - Signals removal of wiring access cover.
- **VOP2** Value Option Package - For the 2022 Series.
- **CLH** Custom Length Housing - See page 24.
- \* **LCB** Basic Lock Less Circuit Board
- **LED** Bi-Color LED - For local signaling of lock status.  
(Requires HSM or VOP Option. Not available on TJ models.)
- **LED2** Bi-Color LED's (2) - For the 2022 Series. (Requires HSM2 or VOP2 Option. Not available on TJ models.)
- # **LP** Low Power Coil - 12V only @ 0.16 Amps (Single Lock)
- **LP2** Low Power Coils - 12V only @ 0.32 Amps (Double Lock)
- **OFA** Offset Armature - For narrow style storefront doors.  
(When ordered with lock)
- **SF** Special Finish - Standard finish US28. Special anodized finishes see page 56.

Notes: • DSM, HSM, VOP and LED options not available on the 2012 Series.  
\* DSM, HSM, VOP and LED options not available with the LCB option.  
# LP option may not be combined with HSM or VOP options.

## 2013 Series 1200 Lb. Gate Lock



2013

Electromagnetic lock, surface mounted for sliding or swinging gates. Face drilled mounting holes, weather resistant, sealed 1/2" conduit fitting with three foot long 22AWG leads.  
 Field selectable 12/24 VDC  
 Size: 1-1/2"D x 2-1/2"H x 9-1/4"L  
 Current Draw: 374 mA @ 12VDC  
 210 mA @ 24VDC



NYC MEA  
 #23-92-E

MODEL	PRODUCT	FINISH	WEIGHT
2013	Electromagnetic Gate Lock - 12/24 VDC	US28	10 Lbs.

### OPTIONS

- DYN** Dynastat Force Sensor - Indicates efficient magnetic bond.
- GLB** Gate Lock Bracket - Fully adjustable "Z" bracket for swinging gate applications.
- GLB2** Gate Lock Bracket - "L" Brackets for sliding gate application.
- RWE** Rear Wire Exit - Coil wiring exits from back of housing in lieu of conduit nipple.
- SF** Special Finish - Standard finish US28. Special anodized finishes see page 56.

Notes: For AC operation order #7088 Pre-wired Rectifier Bridge. See page 48.

## 2513 Series 650 Lb. Mini-Mag Gate Lock



2513

Compact gate lock, surface mounted for sliding or swinging gates. Face drilled mounting holes, weather resistant, sealed 1/2" conduit fitting with three foot long 22AWG leads.  
 Field selectable 12/24 VDC  
 Size: 1-1/4"D x 1-13/16"H x 8"L  
 Current Draw: 381 mA @ 12VDC  
 205 mA @ 24VDC



MODEL	PRODUCT	FINISH	WEIGHT
2513	Mini-Mag Gate Lock - 12/24 VDC	US28	4 Lbs.

### OPTIONS

- DYN** Dynastat Force Sensor - Indicates efficient magnetic bond.
- GLBM** Mini-Mag Gate Lock Bracket - Fully adjustable "Z" bracket for gate applications.
- SF** Special Finish - Standard finish US28. Special anodized finishes see page 56.

Notes: For AC operation order #7088 Pre-wired Rectifier Bridge. See page 48.

## 2050 Series 1200 Lb.

Electromagnetic locks, surface mounted for outswing or inswing single or double doors, designed to exactly retrofit Locknetics 350+ and 352+ Series locks.

Size: 1-11/16"D x 2-1/8"H x 12-1/2"L Single or 25"L Double

Multi-voltage auto-sensing 12/24 VAC/VDC

Current Draw: 583 mA @ 12VDC Single / 1166 mA Double

335 mA @ 24VDC Single / 670 mA Double

Adjustable Relock Time Delay (Former TD Option) is standard on all models.



2050



MODEL	PRODUCT	FINISH	WEIGHT
<b>2050</b>	Locknetics 350+ Exact Retrofit	US28	11 Lbs.
<b>2250</b>	Locknetics 352+ Exact Retrofit	US28	24 Lbs.

## OPTIONS

<b>DSM</b>	Door Status Switch - Signals door closed or ajar.
<b>DSM2</b>	Door Status Switch - For the 2250 Series.
<b>HSM</b>	High Security Monitor. Includes the following: Door Status Switch - Signals door closed or ajar. Dynastat Force Sensor - Indicates efficient magnetic bond.
<b>HSM2</b>	High Security Monitor - For the 2250 Series.
* <b>LCB</b>	Basic Lock Less Circuit Board
<b>LED</b>	Bi-Color LED - For local signaling of lock status. (Requires HSM or VOP Option.)
<b>LED2</b>	Bi-Color LED's (2) - For the 2250 Series. (Requires HSM2 or VOP2 Option.)
<b>SF</b>	Special Finish - Standard finish US28. Special anodized finishes see page 56.

Notes: \* DSM, HSM, VOP and LED options not available with the LCB option.



## 2101 Series 1200 Lb. Early Warning Lock



2101



Electromagnetic lock, surface mounted for outswing doors. Includes early warning door movement sensor output and door status output. Designed to initiate a remote alarm upon unauthorized exit attempts or to trigger an off-site delay egress system.

Size: 1-1/2"D x 2-3/4"H x 11"L

Field selectable 12/24 VDC

Current Draw: 374 mA @ 12VDC  
210 mA @ 24VDC

MODEL	PRODUCT	FINISH	WEIGHT
2101	Single Lock - 12/24 VDC	US28	12 Lbs.

### OPTIONS

**SF** Special Finish - Standard finish US28. Special anodized finishes see page 56.

Notes: For AC operation order #7088 Pre-wired Rectifier Bridge. See page 48.

## 2500 Series 650 Lb. Early Warning Lock



2511-EWT



Mini electromagnetic lock, surface mounted for single outswing door. Includes early warning door movement sensor output and door status output.

Size: 1-1/4"D x 1-3/16"H x 10-1/2"L

Multi-voltage field selectable 12/24VDC (Requires part #7088 (Pre-wired Rectifier Bridge) for VAC

Current Draw: 381 mA @ 12V  
205 mA @ 24V

MODEL	PRODUCT	FINISH	WEIGHT
2511-EWT	Single Lock - 12/24 VDC	US28	6 Lbs.

### OPTIONS

**DYN** DYNASTAT FORCE SENSOR - Indicates efficient magnetic bond  
**LED** BI-COLOR LED - For local signaling of lock status (Requires DYN)  
**SF** SPECIAL FINISH - Standard finish is US28 (Satin Aluminum). For special anodized finishes, see page 56.

## 2268 Series 1200 Lb. Classic Low Profile



2268-10



2268-15



2268-20



2268-TJ10



2268-TJ20

"Classic" low profile electromagnetic locks, surface mounted for single and double outswing or inswing doors. Retrofits some existing locks.

Size: 2-3/16"D x 2"H x 14"L Single or 25"L Double

Multi-voltage field-selectable 12/24 VDC

Current Draw: 583 mA @ 12VDC Single / 1166 mA Double

335 mA @ 24VDC Single / 670 mA Double



MODEL	PRODUCT	FINISH	WEIGHT
<b>2268-10</b>	Single Electromagnetic Lock Outswing	US28	9 Lbs.
<b>2268-10-DSE</b>	Single Lock Outswing, 24VDC, With DYN Option	US28	9 Lbs.
<b>2268-15</b>	Single Electromagnetic Lock Pair Outswing	US28	9 Lbs.
<b>2268-20-DSE</b>	Double Lock Outswing, 24VDC, With DYN2 Option	US28	18 Lbs.
<b>226820</b>	Double Electromagnetic Lock Pair Outswing	US28	18 Lbs.
<b>2268-TJ10</b>	Single Electromagnetic Lock Inswing	US28	12 Lbs.
<b>2268-TJ20</b>	Double Electromagnetic Lock Pair Inswing	US28	24 Lbs.

### OPTIONS

- ATS** Anti-Tamper Switch - Signals removal of the housing cover.
- **DSM** Door Status Switch - Signals door closed or ajar.
- DSM2** Door Status Switch - For the 2268-20 Series.
- **DYN** Dynastat Force Sensor - Indicates efficient magnetic bond.
- DYN2** Dynastat Force Sensor - For the 2268-20 Series.
- **LED** Bi-Color LED - For local signaling of lock status.  
(Requires DYN Option)
- LED2** Bi-Color LED's (2) - For the 2268-20 Series.  
(Requires DYN2 Option)
- SF** Special Finish - Standard finish US28. Special anodized finishes see page 56.
- TD** Time Delay - 1-60 seconds. For 2268-10 & 2268-15 only.
- TD2** Time Delay - 1-60 seconds. For the 2268-20 only.

Notes: • DSM, DYN and LED options not available on the 2268-15 Series.  
For AC Operation order #7088 Pre-wired recritier bridge. See page 48.

## 2600 Series 650 Lb. Mortise Lock



2600

Electromagnetic lock, mortise mounted for sliding door.

Field selectable 12/24 VDC

Size: 1-1/2"W x 8-3/4"H x 1-1/8"D

Current Draw: 381 mA @ 12VDC

205 mA @ 24VDC

MODEL	PRODUCT	FINISH	WEIGHT
<b>2600</b>	Single Mortise Lock - 12/24 VDC	US28	4 Lbs.

### OPTIONS

- AMB** Armature Mounting Block
- DYN** Dynastat Force Sensor - Indicates efficient magnetic bond.
- MB** Mounting Brackets - Two piece kit.
- SF** Special Finish - Standard finish US28. Special anodized finishes see page 56.

Notes: For AC operation order #7088 Pre-wired Rectifier Bridge. See page 48.

## 2280 Series 1200 Lb. SlimLine



2280



2282



2280-TJ80



2282-TJ82



New "upscale" low profile electromagnetic locks, surface mounted for single and double outswing or inswing doors. Seamless one-piece lock housings mount with an adjustable baseplate for quicker installations. Armatures utilize high-impact plastic housings, with incorporated foam pads to reduce noise. When ordered with DSM, concealed disc magnets are included at each end of the armature housings.

Size: 1-1/2"D x 2-1/16"H x 12-3/4"L Single or 25-1/2"L Double

Multi-voltage field selectable 12/24 VDC/VAC

Current Draw: 583 mA @ 12VDC Single / 1166 mA Double

335 mA @ 24VDC Single / 670 mA Double

Adjustable Relock Time Delay (Former TD Option) is standard on all models.

MODEL	PRODUCT	FINISH	WEIGHT
<b>2280</b>	Single Electromagnetic Lock Outswing	US28	9 Lbs.
<b>2282</b>	Double Electromagnetic Lock Pair Outswing	US28	18 Lbs.
<b>2280-TJ80</b>	Single Electromagnetic Lock Inswing	US28	12 Lbs.
<b>2282-TJ82</b>	Double Electromagnetic Lock Pair Inswing	US28	24 Lbs.

### OPTIONS

<b>DSM</b>	Door Status Switch - Signals door closed or ajar.
<b>DSM2</b>	Door Status Switch - For the 2282 Series.
<b>HSM</b>	High Security Monitor. Includes the following: Door Status Switch - Signals door closed or ajar. Dynastat Force Sensor - Indicates efficient magnetic bond.
<b>HSM2</b>	High Security Monitor - For the 2282 Series.
<b>LCB</b>	Basic Lock Less Circuit Board
<b>LED</b>	Bi-Color LED - For local signaling of lock status. (Requires HSM or VOP Option.)
<b>LED2</b>	Bi-Color LED's (2) - For the 2282 Series. (Requires HSM2 or VOP2 Option.)
<b>SF</b>	Special Finish - Standard finish US28. Special anodized finishes see page 56.

Notes: \* DSM, HSM, VOP and LED options not available with the LCB option.



2511



2522



2511TJ



2522TJ2



2585



2585-TJ85

## 2500 Series 650 Lb. "Mini"

Mini electromagnetic locks, surface mounted for single and double outswing or inswing doors.  
 Size: 1-1/4"D x 1-3/4"H x 10-1/2"L Single or 21"L Double  
 Multi-voltage field selectable 12/24 VAC/VDC  
 Current Draw: 381 mA @ 12V Single / 762 mA Double  
 205 mA @ 24V Single / 410 mA Double

MODEL	PRODUCT	FINISH	WEIGHT
<b>2511</b>	Single Electromagnetic Lock Outswing	US28	4.5 Lbs.
<b>2522</b>	Double Electromagnetic Lock Pair Outswing	US28	9 Lbs.
<b>2511TJ</b>	Single Electromagnetic Lock Inswing	US28	7.5 Lbs.
<b>2522TJ2</b>	Double Electromagnetic Lock Pair Inswing	US28	15 Lbs.

## 2585 Series 650 Lb. "Bantam"

"Bantam" electromagnetic lock, surface mounted for single outswing or inswing doors.  
 Size: 1-1/4"D x 1-3/4"H x 8-1/2"L  
 Field Selectable 12/24 VDC.  
 Current Draw: 500 mA @ 12VDC  
 250 mA @ 24VDC

MODEL	PRODUCT	FINISH	WEIGHT
<b>2585</b>	Single Lock Outswing	US28	4 Lbs.
<b>2585-TJ85</b>	Single Lock Inswing	US28	8 Lbs.

## OPTIONS

- **ATS** Anti-Tamper Switch - Signals removal of the housing cover.
- **CLH** Custom Length Housing - See page 24.
- DSM** Door Status Switch - Signals door closed or ajar.
- DSM2** Door Status Switch - For the 2522 Series only.
- DYN** Dynastat Force Sensor - Indicates efficient magnetic bond.
- DYN2** Dynastat Force Sensor - For the 2522 Series only.
- LED** Bi-Color LED - For local signaling of lock status.  
(Requires DYN Option. Not available on TJ models.)
- LED2** Bi-Color LED's (2) - For the 2522 Series only.  
(Requires DYN2 Option. Not available on TJ models.)
- SF** Special Finish - Standard finish US28. Special anodized finishes see page 56.

Notes: • ATS and CLH options not available on the 2585 Series.

Note: For AC operation order #7088 Pre-wired Rectifier Bridge. See page 48.





2801



2802



2804



2805



2806



2810



2860



2863



2870

## 2800 Series Electromagnetic Door Holders

DynaLock 2800 Series Electromagnetic Door Holders accept Tri-Voltage, 12VDC, 24VAC/VDC, or 120VAC input (Model 2810 is 24VAC/VDC, only). Standard models are offered for single or double doors and deliver 30-45 lbs. holding force. High-security Model 2810 delivers 400 lbs. holding force.

CURRENT DRAW	VOLTAGE
0.060 AMPS	12VDC
0.030 AMPS	24VAC/VDC
0.105 AMPS	24VAC/VDC (2810)
0.030 AMPS	120VAC



MODEL	PRODUCT	WEIGHT
<b>2801</b>	Floor Mount, Single Door	4.2 Lbs.
<b>2802</b>	Floor Mount, Double Door	6.1 Lbs.
<b>2803</b>	Flush Wall Mount, 1" Extended Armature	2 Lbs.
<b>2804</b>	Flush Wall Mount, Standard Armature	2 Lbs.
<b>2805</b>	Surface Wall Mount	2.5 Lbs.
<b>2806</b>	Low Profile Wall Mount	2.5 Lbs.
<b>2810</b>	Surface Wall Mount, 400 lbs. Holding Force	4.9 Lbs.

ACCESSORIES	PRODUCT	WEIGHT
<b>2860</b>	Door Armature & Base, Replacement	.5 Lbs.
<b>2861</b>	Armature Extension, 1/2"	.1 Lbs.
<b>2862</b>	Armature Extension, 3/4"	.1 Lbs.
<b>2863</b>	Armature Extension, 1"	.1 Lbs.
<b>2864</b>	Armature Extension, 2"	.1 Lbs.
<b>2865</b>	Armature Extension, 4"	.2 Lbs.
<b>2866</b>	Armature Extension, 6"	.3 Lbs.
<b>2870</b>	Armature Swivel Extension	.1 Lbs.

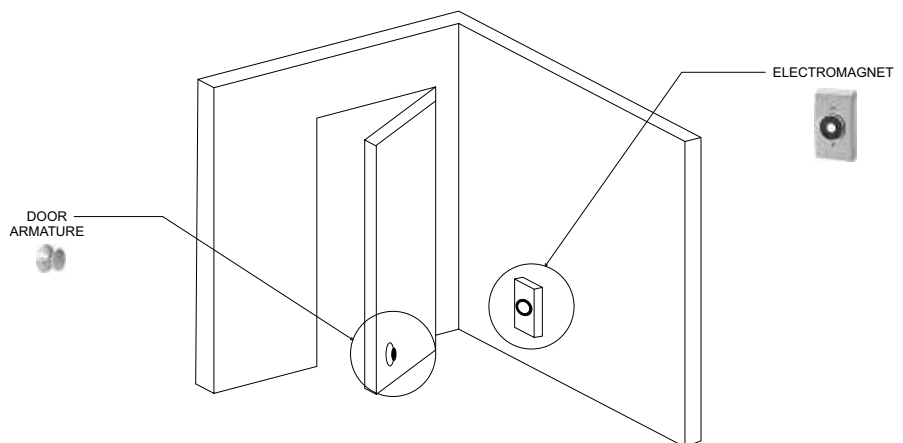

# Product Approvals



SERIES	DESCRIPTION	FILE NO.
<b>1600 SERIES:</b>	UL Burglary-Resistant Electric Door Strikes	FILE #BP7294
<b>1900 SERIES:</b>	INTERTEK UL10C (3-hour) Fire-Rated (1921 only)	
	UL Burglary-Resistant Electric Door Strikes	FILE #BP7294
<b>ECL-1 SERIES:</b>	UL Electrically Controlled Single-point Lock and Latches	FILE #R16716
<b>EML SERIES:</b>	UL Electrically Controlled Single-point Lock and Latches	FILE #R16716
<b>ETH/ETM SERIES:</b>	UL Door Hinges	FILE #R38673
<b>EMK-VON SERIES:</b>	UL Accessories Single-point Locks and Latches Fire & Exit Hardware	FILE #R38672
<b>2000 SERIES:</b>	UL & CUL Auxiliary Locking Device	FILE #R15538
	UL Access Control System Units (UL 294)	FILE #BP8819
	MEA City of New York Dept. of Buildings	MEA 23-92-E Vol.II
<b>2050 SERIES:</b>	UL & CUL Auxiliary Locking Device	FILE #R15538
	UL Access Control System Units (UL 294)	FILE #BP8819
<b>2268 SERIES:</b>	UL & CUL Auxiliary Locking Device	FILE #R15538
	UL Access Control System Units (UL 294)	FILE #BP8819
<b>2280 SERIES:</b>	UL & CUL Auxiliary Locking Device	FILE #R15538
	UL Access Control System Units (UL 294)	FILE # P8819
<b>2500 SERIES:</b>	UL & CUL Auxiliary Locking Device	FILE #R15538
	UL Access Control System Units (UL 294)	FILE #BP8819
	MEA City of New York Dept. of Buildings	MEA 23-92-E Vol.II
<b>2585 SERIES:</b>	UL & CUL Auxiliary Locking Device	FILE #R15538
	UL Access Control System Units (UL 294)	FILE #BP8819
<b>2800 SERIES:</b>	UL & CUL Fire Door Holders	FILE #R26798
	UL Releasing Devices	FILE #S4665
<b>3000 SERIES:</b>	UL & CUL Auxiliary Locking Device	FILE #R15538
	UL Access Control System Units (UL 294)	FILE #BP8819
	MEA City of New York Dept. of Buildings	MEA 23-92-E Vol.II
	CSFM California State Fire Marshal	#3774-1457:101
<b>3006 SERIES:</b>	UL & CUL Auxiliary Locking Device	FILE #R15538
	UL Access Control System Units (UL 294)	FILE #BP8819
<b>3101C SERIES:</b>	UL Special Locking Arrangements (UL 294)	FILE #SA9532
	UL & CUL Auxiliary Locking Device	FILE #R15538
	UL Access Control System Units (UL 294)	FILE #BP8819
	CHGO City of Chicago Dept. of Buildings	CODE #13-160-269
	CSFM California State Fire Marshal	#3774-1457:100
<b>5725, 5800, 5850, 5900, 5950 SERIES:</b>	UL Access Control System Units (UL 294)	FILE #BP8819
	CAN/ULC-60839-11-1 Alarm & Electronic Security Systems (Canada)	
	CAN/ULC-S533 Egress Door Releasing Devices (Canada)	
	CE European Compliance	
	FCC U.S. Federal Communications Commission	
	Industry Canada Canadian Registration	
<b>5725, 5800, 5900 SERIES:</b>	CUL Access Control Systems Units (Canada)	FILE #BP8819
	UL & CUL Special Locking Arrangements (UL 294)	FILE #SA9532
	UL & CUL Power Supplies, Burglar Alarm System (UL603)	FILE #BP21187
	UL Power Supply Units (UL1481)	FILE #S36235
<b>5800, 5900 SERIES:</b>	CAN/ULC-S527 Control Units for Fire Alarm Systems (Canada)	
<b>6420 SERIES:</b>	UL & CUL Access Control System Units (UL 294)	FILE #BP8819
<b>6451 SERIES:</b>	UL & CUL Access Control System Units	FILE #BP8819
	MEA City of New York Dept. of Buildings	MEA 23-92-E Vol.II
	CSFM California State Fire Marshal	#3774-1457:102

## 3000 Series 1500 Lb.

Electromagnetic locks, surface mounted for outswing or inswing single or double doors.

Size: 1-1/2"D x 2-3/4"H x 11"L Single or 22"L Double

Multi-voltage auto-sensing 12/24 VAC/VDC

Current Draw: 374 mA @ 12VDC Single / 748 mA Double

210 mA @ 24VDC Single / 420 mA Double

Adjustable Relock Time Delay (Former TD Option) is standard on all models.



3000



3001



3002

MODEL	PRODUCT	FINISH	WEIGHT
<b>3000</b>	Single Electromagnetic Lock Outswing	US28	10 Lbs.
<b>3001</b>	Single Electromagnetic Lock Pair Outswing	US28	10 Lbs.
<b>3002</b>	Double Electromagnetic Lock Outswing	US28	20 Lbs.
<b>3000TJ30</b>	Single Electromagnetic Lock Inswing	US28	13 Lbs.
<b>3002TJ32</b>	Double Electromagnetic Lock Pair Inswing	US28	26 Lbs.

### OPTIONS

- **DSM** Door Status Switch - Signals door closed or ajar.
- **DSM2** Door Status Switch - For the 3002 Series.
- **HSM** High Security Monitor. Includes the following:  
Door Status Switch - Signals door closed or ajar.  
Dynastat Force Sensor - Indicates efficient magnetic bond.
- **HSM2** High Security Monitor - For the 3002 Series.
- **VOP** Value Option Package. Includes the following:  
Door Status Switch - Indicates door closed or ajar.  
Dynastat Force Sensor - Indicates efficient magnetic bond.  
Anti-Tamper Switch - Signals removal of wiring access cover.
- **VOP2** Value Option Package - For the 3002 Series.
- **CLH** Custom Length Housing - See page 24.
- **\* LCB** Basic Lock Less Circuit Board
- **LED** Bi-Color LED - For local signaling of lock status.  
(Requires HSM or VOP Option. Not available on TJ models.)
- **LED2** Bi-Color LED's (2) - For the 3002 Series. (Requires HSM2 or VOP2 Option. Not available on TJ models.)
- **# LP** Low Power Coil - 12V only @ 0.16 Amps (Single Lock)
- **LP2** Low Power Coils - 12V only @ 0.32 Amps (Double Lock)
- **OFA** Offset Armature - For narrow style storefront doors.  
(When ordered with lock)
- **SF** Special Finish - Standard finish US28. Special anodized finishes see page 56.



NYC MEA  
#23-92-E

CSFM

- Notes:
- DSM, HSM, VOP and LED options not available on the 3001 Series.
  - \* DSM, HSM, VOP and LED options not available with the LCB option.
  - # LP option may not be combined with HSM or VOP options.

## Custom Length Housings - Horizontal and Vertical

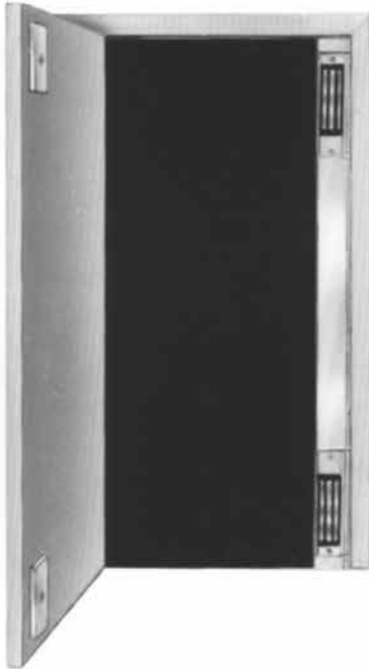

### 3700 - 3750

Vertical Custom Length Housing:  
Measure dimension floor to bottom of header stop then subtract 1/8". Housing is non-handed.

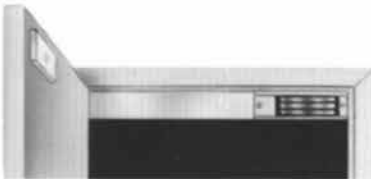

### 3500 - 3550

Horizontal Custom Length Housing:  
Measure dimension between vertical stops then subtract 1/8". Housing is handed - LHR shown.

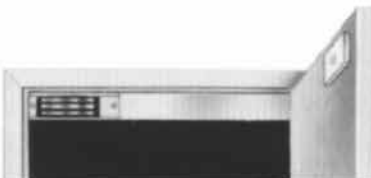

### 3600 - 3650

Horizontal Custom Length Housing:  
Measure dimension between vertical stops then subtract 1/8". Housing is handed - RHR shown.

### Custom Length Housings

Custom Length Housings Series' 3500, 3600, 3700 and 3800 may be used with any full size 2000 or 3000 Series electromagnetic lock except the 3006 and 3101B Series. Custom Length Housings 3550, 3650, 3750 and 3850 are designed for use with 2511 and 2522 Mini electromagnetic locks only.

Custom Length Housings provide an unbroken sight line across the header or along a vertical jamb, for a less conspicuous installation. Installation is easy, standard locks are mounted in the conventional manner, a pre-cut track is installed in line with the lock and a "U" shaped channel is attached to the track, concealing both track and lock. Both track and housing ends may be field trimmed as required on all models except the 3700 and 3750.

### MODEL

### PRODUCT

<b>3500</b>	CLH - LHR 30" to 48" Single Horizontal Lock - Single Door. Full Size.
<b>3550</b>	CLH - LHR 30" to 48" Single Horizontal Lock - Single Door. Mini.
<b>3600</b>	CLH - RHR 30" to 48" Single Horizontal Lock - Single Door. Full Size.
<b>3650</b>	CLH - RHR 30" to 48" Single Horizontal Lock - Single Door. Mini.
<b>3700</b>	CLV to 96" Two Vertical Locks - Single Door. Full Size.
<b>3750</b>	CLV to 96" Two Vertical Locks - Single Door. Mini.
<b>3800</b>	CLH to 96" Two Horizontal Locks - Double Door. Full Size.
<b>3850</b>	CLH to 96" Two Horizontal Locks - Double Door. Mini.

### Note:

Pricing is for Housing only, locks must be ordered separately. Housings are furnished in US28 finish. For special finishes see page 52. Special lengths or modifications to standard housings are available - consult factory for price and delivery.



### 3800 - 3850

Horizontal Custom Length Housing:  
Measure dimension between vertical stops then subtract 1/8". Housing is non-handed and may be installed only when no center mullion is present.



## 3006 Series 1500Lb. Free Egress Maglock



3006

Electromagnetic locks, surface mounted for outswing doors. PIR sensor for immediate door release. Includes independent, adjustable access and egress control time delay functions.  
 Size: 3"D x 2-3/4"H x 11"L  
 Multi-voltage field selectable 12/24 VAC/VDC  
 Current Draw: 426 mA @ 12V / 262 mA @ 24V

MODEL	PRODUCT	FINISH	WEIGHT
3006	Single Electromagnetic Lock with Built-in P.I.R.	US28	12 Lbs.



NYC MEA  
#23-92-E

CSFM

### OPTIONS

- DSM** Door Status Switch - Signals door closed or ajar.
- HSM** High Security Monitor. Includes the following:
  - Door Status Switch - Signals door closed or ajar
  - Dynastat Force Sensor - Indicates efficient magnetic bond.
- # LP** Low Power Coil - 12V only @ 0.2 Amps.
- ATS** Anti-Tamper Switch - signals removal of the housing cover.
- OFA** Offset Armature - For narrow style storefront doors.  
(When ordered with lock)
- SF** Special Finish - Special anodized finishes see page 56.

Notes: # LP option may not be combined with HSM option.  
 3006 is NOT Field-handable.

## 3101C Series 1500 Lb. Delay Egress System (Generation II)



Delay egress electromagnetic locks, surface mounted for outswing single or double doors and inswing single doors. Non-handed.

- Sizes: 3"D x 2-3/4"H x 11"L (3101C)  
 3"D x 2-3/4"H x 22"L (3121C)  
 3"D x 2-3/4"H x 11"L ea. (3121C2)  
 2-3/4"D x 4"H x 11"L (3101C-TJ101)

Multi-voltage auto-sensing 12/24 VAC/VDC

Current Draw: 456 mA @ 12VDC / 263 mA @ 24VDC (3101C, 3101C-TJ101)  
 849 mA @ 12VDC / 480 mA @ 24VDC (3121C, 3121C2)



MODEL	PRODUCT	FINISH	WEIGHT
<b>3101C-G2</b>	Single Delay Egress Lock Outswing	US28	12 Lbs.
<b>3121C-G2</b>	Double Delay Egress Lock Pair Outswing	US28	24 Lbs.
<b>3121C2-G2</b>	Double Delay Egress Lock Pair Outswing Tandem Unit To Accommodate Center Mullion	US28	24 Lbs.
<b>3101C-TJ101-G2</b>	Single-Inswing Delay Egress Lock Kit Includes "Z" Bracket, Shim Plate, Door Sign, Wall-Mount Keyswitch (#7054)	US28	15 Lbs.

### OPTIONS



- AAO** Auxiliary Alarm Output - 2nd delay egress output, SPDT.
- ATS** Anti-Tamper Switch - Signals removal of the housing cover.
- ATS2** Anti-Tamper Switch - For the 3121C and 3121C2
- **BPM** Bypass Monitor - Signals bypass keyswitch activation
- DSM** Door Status Switch - Signals door closed or ajar.
- DSM2** Door Status Switch - For the 3121C and 3121C2.
- DYN** Dynastat Force Sensor - Indicates efficient magnetic bond.
- DYN2** Dynastat Force Sensor - For the 3121C and 3121C2.
- ETR** Egress Sensor Omitted - For externally triggered egress.
- KSO** Keyswitch Omitted - In favor of separate remote keyswitch. (Suggested for door heights over 8 ft.) See page 39.
- \* **LP** Low Power Coil - 12V only @ 0.40 Amps (Single Lock)
- LP2** Low Power Coils - 12V only @ 0.72 Amps (Double lock)
- SF** Special Finish - Standard finish US28. Special anodized finishes see page 56.



### BUILDING CODE SOFTWARE OPTIONS (FACTORY INSTALLED)

- BOCA** For operation in compliance with BOCA Code.
- UBC** For operation in compliance with UBC Code.
- CHGO** For operation in compliance with Chicago Building Code.

Notes: • BPM option not available with the KSO option.

\* LP option may not be combined with DYN option.

### COMMON REPLACEMENT ITEMS

- 300477** Door sign only, 15 second delay verbiage.
- 300478** Door sign only, 30 second delay verbiage.
- 301393** Egress Sensor Adjustment Wheel Kit.
- 301424** "PULL" Door Sign, 3101C-TJ101/3101C-TJ101-G2.
- 301556** Mounting Hardware Kit, 3101C-G2.



3101C-ES



3101C-R

## 3101C-ES Series

Delay egress electronics mounted in enclosure with screw terminal block for hook-up wiring. Typical applications include outside gates and in-swing doors requiring delay egress. Other components are necessary to function properly, see below for more information. BOCA software is available (consult factory).

MODEL	PRODUCT	WEIGHT
<b>3101C-ES</b>	Delay Egress Controller mounted in 15"x12"x4" steel enclosure	12 Lbs.
<b>3101C-R</b>	Delay Egress Controller mounted in 12"x12"x6" weatherproof enclosure, with mounted alarm horn	17 Lbs.



GLB



GLB2



4880



4852



301238



4951



TJ80

## Gate Lock Bracket

Adjustable gate lock brackets facilitate mounting to a variety of gate and post styles.

MODEL	PRODUCT	WEIGHT
<b>GLB</b>	Two piece "Z" bracket for swinging gates	3 Lbs.
<b>GLB2</b>	Two "L" brackets for sliding gates	3 Lbs.

## Glass Door Brackets

Glass door brackets facilitate mounting an armature to a glass door with no top rail. Rubber and metal shims protect glass during installation. Brackets will fit 3/8", 1/2" or 3/4" thick doors.

MODEL	USE WITH	WEIGHT
<b>4850</b>	2011, 2022*, 3000, 3002*	2 Lbs.
<b>4852</b>	2012, 3001 (pair)	2 Lbs.
<b>4854</b>	2511, 2522*	2 Lbs.
<b>4855</b>	2585	2 Lbs.
<b>4856</b>	2268-10, 2268-20*	2 Lbs.
<b>4858</b>	2268-15 (pair)	2 Lbs.
<b>4880</b>	2280, 2282*	2 Lbs.
<b>4801</b>	3101B	2 Lbs.

\* For double locks order two.

## Miscellaneous

MODEL	PRODUCT	WEIGHT
<b>301000</b>	180 Piece Hardware Kit - An assortment of commonly used hardware for DynaLock electromagnetic locks. For 2000/3000 Series.	1.5 Lbs.
<b>301238</b>	Hardware Kit. For 3101/3101B Series.	2 Lbs.
<b>4920</b>	Metal Template for Model 2011.	2.5 Lbs.
<b>4930</b>	Metal Template for Model 3000.	2.5 Lbs.
<b>4940</b>	Metal Template for Model 3101B.	2.5 Lbs.
<b>4951</b>	Concrete/Wood Bracket for 2011/3000LC Size: 1-1/2"D x 1/2"H x 11"L	1 Lbs.

## Top Jamb Conversion Kits

Kits convert 2000, 3000 and 2280 Series locks to top jamb mounting applications on inswing doors. All kits include "Z" armature bracket(s) and mounting hardware. 2000 and 2280 kits also include "L" lock conversion bracket.

MODEL	PRODUCT	WEIGHT
<b>TJ20</b>	Converts 2011 to 2011-TJ20	3 Lbs.
<b>TJ21</b>	Converts 2012 to 2012-TJ21	3 Lbs.
<b>TJ22</b>	Converts 2022 to 2022-TJ22	6 Lbs.
<b>TJ25</b>	Converts 2511 to 2511TJ	3 Lbs.
<b>TJ30</b>	Converts 3000 to 3000-TJ30	3 Lbs.
<b>TJ31</b>	Converts 3001 to 3001-TJ31	3 Lbs.
<b>TJ32</b>	Converts 3002 to 3002-TJ32	6 Lbs.
<b>TJ80</b>	Converts 2280 to 2280-TJ80	3 Lbs.
<b>TJ82</b>	Converts 2282 to 2282-TJ82	6 Lbs.

Note: See page 52 for available special finishes on above kits and brackets.

## Filler & Spacer Plates Angle Brackets

### 4000 Series Filler Plates

Filler plates facilitate the mounting of electromagnetic locks by extending the width of the door stop to provide an adequate mounting surface. Where required, select a Filler Plate equal in thickness to the height of the door stop (i.e. Dim. "A").

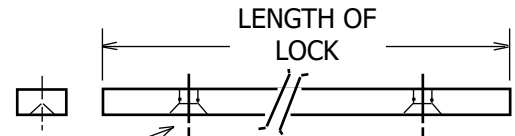
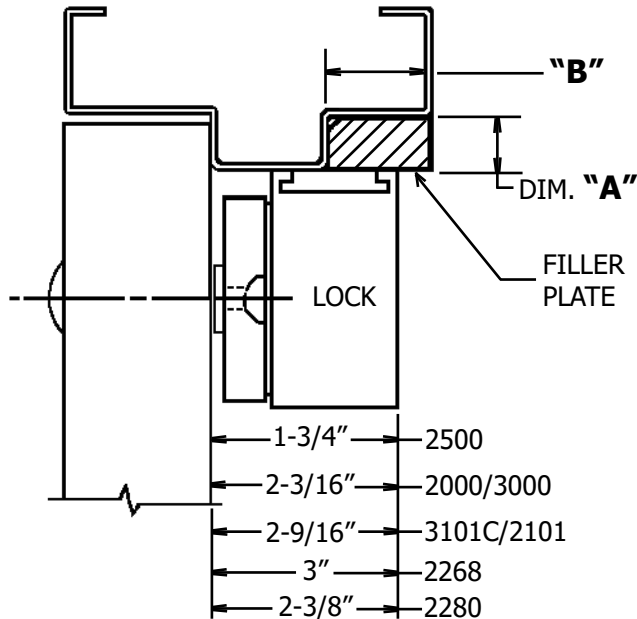

TYPICAL,  
#10 FHS FOR 1/8" & 1/4" THICKNESS  
#12 FHS FOR 3/8" & LARGER THICKNESS

### 4000 Series Spacer Plates

Spacer plates facilitate the mounting of electromagnetic locks by lowering the entire assembly 1/2", to clear a blade stop. All plates are pre-drilled for the corresponding lock series.

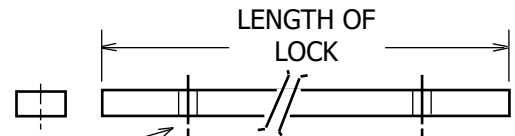
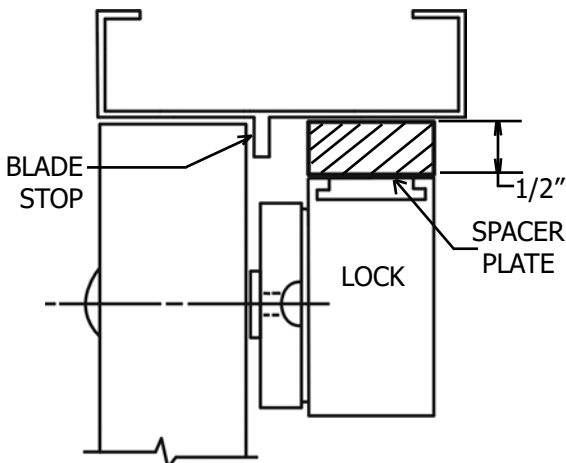

TYPICAL,  
COMES WITH CORRESPONDING MOUNTING  
HARDWARE. HOUSING SCREWS MOUNT  
THROUGH SPACER PLATE INTO FRAME.

### 4000 Series Angle Brackets

Angle Brackets facilitate the mounting of electromagnetic locks by extending the frame header area to provide an adequate mounting surface. Where required, select an Angle Bracket appropriate to accommodate the mounting footprint of the lock.

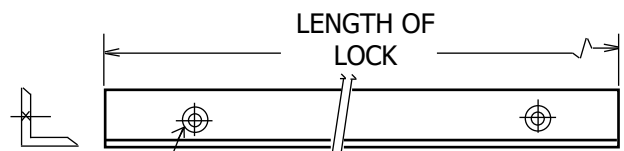
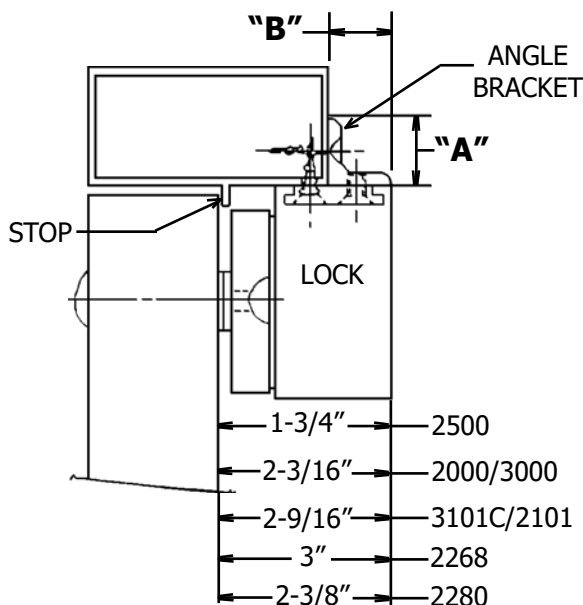

#10 FHS  
TYPICAL

## Filler Plates

### Single MagLocks

SIZE A x B	2000/3000/3101C (11")	2268-10/15 (14")	2511 (10-1/2")	2585 (8-1/2")	2280 (12-3/4")
1/8 x 1-1/4	#4011	#4014	#4010	#4085	#4080
1/4 x 1-1/4	#4111	#4114	#4110	#4185	#4180
3/8 x 1-1/4	#4211	#4214	#4210	#4285	#4280
1/2 x 1-1/4	#4311	#4314	#4310	#4385	#4380
5/8 x 1-1/4	#4411	#4414	#4410	#4485	#4480
3/4 x 1-1/4	#4441	#4415	#4430	#4486	#4448

### Double MagLocks

SIZE A x B	2022/3002/3121C (22")	2268-20 (25")	2522 (21")	2282 (25-1/2")	CUSTOM LENGTH L = LENGTH (Specify)
1/8 x 1-1/4	#4022	#4025	#4020	#4082	#4000-L
1/4 x 1-1/4	#4122	#4125	#4120	#4182	#4100-L
3/8 x 1-1/4	#4222	#4225	#4220	#4282	#4200-L
1/2 x 1-1/4	#4322	#4325	#4320	#4382	#4300-L
5/8 x 1-1/4	#4422	#4425	#4420	#4482	#4400-L
3/4 x 1-1/4	#4442	#4426	#4450	#4449	#4440-L

## Spacer Plates

2000/3000/3101C	2511	2522	2585	2268-10/15	2268-20	2280	2282
#4301	#4302	#4303	#4304	#4305	#4306	#4307	#4308

NOTE: For 2022, 3002, & 3121C order 2 Spacer Plates for each lock. All Spacer Plates are 1/2" thick and the same depth and length as the lock. Proper hardware packs included.

## Angle Brackets

### Single MagLocks

SIZE A x B	2000/3000/3101C (11")	2268-10/15 (14")	2511 (10-1/2")	2585 (8-1/2")	2280 (12-3/4")
1 x 1	#4511	#4514	#4510	#4585	#4580
1-1/2 x 1-1/2	#4611	#4614	#4610	#4685	#4680
1-1/2 x 2	#4711	#4714	#4710	#4785	#4780

### Double MagLocks

SIZE A x B	2022/3002/3121C (22")	2268-20 (25")	2522 (21")	2282 (25-1/2")	CUSTOM LENGTH L = LENGTH (Specify)
1 x 1	#4522	#4525	#4520	#4582	#4500-L
1-1/2 x 1-1/2	#4622	#4625	#4620	#4682	#4600-L
1-1/2 x 2	#4722	#4725	#4720	#4782	#4700-L



5725

## 5725 Power Supply

- Selectable 12/24VDC Output at 1.5A Overall Continuous
- Dual 500mA Class 2 Lock Outputs, each with 1A overcurrent protection
- Auxiliary 500mA Class 2 Output
- Supervised Fire Alarm/Access Control Interface
- Choice of optional 7 or 12 AH battery back-up capacity
- AC Fail, Battery Presence/Fail Supervision
- Key-locked, hinged cover metal enclosure - 12.7"W x 13"H x 4.3"D

MODEL	PRODUCT	WEIGHT
<b>5725</b>	Power Supply/Charger, 12/24VDC @ 1.5A	8 Lbs.

### OPTIONS

<b>BBU1-7</b>	Battery Back-up - 4 AH @ 12VDC, 1 battery.	6 Lbs.
<b>BBU1-12</b>	Battery Back-up - 12 AH @ 12VDC, 1 battery.	8.5 Lbs.
<b>BBU2-7</b>	Battery Back-up - 7 AH @ 24VDC, 2 batteries.	12 Lbs.
<b>BBU2-12</b>	Battery Back-up - 12 AH @ 24VDC, 2 batteries.	17 Lbs.
<b>PC</b>	Power Cord - Six foot, grounded line cord with NEMA 5-15P plug end.	0.7 Lbs
<b>TS1</b>	Single Tamper Switch - Monitors enclosure lid.	0.2 Lbs.
<b>TS2</b>	Dual Tamper Switches - Monitor lid & enclosure bottom tamper.	0.3 Lbs.



### ACCESSORIES

<b>500259</b>	Interlock Logic Board. Accessory Controller board with 4 independently triggerable 12/24VDC DPDT relays. Facilitates interlock sequencing of 2 to 3 magnetically locked doors. Self-adhesive tape mount. Consult factory for required system components based on desired interlock operation.	0.4 Lbs.
---------------	---	----------

## Power Supply Maximum Lock Capacity Chart

OUTPUT VOLTAGE	MAX LOAD	LOCKING DEVICE					
		1300	2511	2011/3000	2268-10	3006	3101C
12VDC	1A	1	2	2	1	2	2
24VDC	1A	2	4	4	2	3	3
<b>RATINGS PER LOCK</b>		850mA@12V 450mA@24V	381mA@12V 205mA@24V	374mA@12V 210mA@24V	583mA@12V 335mA@24V	426mA@12V 262mA@24V	456mA@12V 263mA@24V



5800



5850

## 5800 SERIES POWER SUPPLY/CHARGERS

- Selectable 12/24VDC Output at 3A Continuous
- 4-zone power distribution board with 2A fused Class 2 outputs (5850)
- Supervised Fire Alarm/Access Control Interface (5850)
- Optional 12 AH battery back-up capacity
- AC Fail, Battery Presence/Fail Supervision
- Key-locked, hinged cover metal enclosure - 13.3"W x 17.6"H x 4.3"D

MODEL	PRODUCT	WEIGHT
<b>5800</b>	Power Supply/Charger, 12/24VDC @ 3A	10 Lbs.
<b>5850</b>	Power Supply/Charger, 12/24VDC @ 3A, with 4-zone distribution controller, 2A fused Class 2 lock outputs & supervised fire alarm/access control interface.	10 Lbs.

## OPTIONS

<b>BBU1-12</b>	Battery Back-up - 12 AH @ 12VDC, 1 battery.	8.5 Lbs.
<b>BBU2-12</b>	Battery Back-up - 12 AH @ 24VDC, 2 batteries.	17 Lbs.
<b>PC</b>	Power Cord - Six foot, grounded line cord with NEMA 5-15P plug end.	0.7 Lbs
<b>TS1</b>	Single Tamper Switch - Monitors enclosure lid.	0.2 Lbs.
<b>TS2</b>	Dual Tamper Switches - Monitor lid & enclosure bottom tamper.	0.3 Lbs.

## ACCESSORIES

<b>500259</b>	Interlock Logic Board. Accessory Controller board with 4 independently triggerable 12/24VDC DPDT relays. Facilitates interlock sequencing of 2 to 3 magnetically locked doors. Self-adhesive tape mount. Consult factory for required system components based on desired interlock operation.	0.4 Lbs.
---------------	---	----------

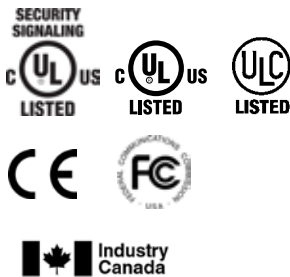

## Power Supply Maximum Lock Capacity Chart

OUTPUT VOLTAGE	MAX LOAD	LOCKING DEVICE					
		1300	2511	2011/3000	2268-10	3006	3101C
12VDC	3A	3	7	7	5	6	6
24VDC	3A	6	14	14	8	11	11
<b>RATINGS PER LOCK</b>		850mA@12V 450mA@24V	381mA@12V 205mA@24V	374mA@12V 210mA@24V	583mA@12V 335mA@24V	426mA@12V 262mA@24V	456mA@12V 263mA@24V





5900



5950



## 5900 SERIES POWER SUPPLY/CHARGERS

- Selectable 12/24VDC Output at 6A Continuous
- 8-zone power distribution board with 2A fused Class 2 outputs (5950)
- Supervised Fire Alarm/Access Control Interface (5950)
- Optional 12 AH battery back-up capacity
- AC Fail, Battery Presence/Fail Supervision
- Key-locked, hinged cover metal enclosure - 13.3"W x 17.6"H x 4.3"D

MODEL	PRODUCT	WEIGHT
<b>5900</b>	Power Supply/Charger, 12/24VDC @ 3A	10 Lbs.
<b>5950</b>	Power Supply/Charger, 12/24VDC @ 3A, with 8-zone distribution controller, 2A fused Class 2 lock outputs & supervised fire alarm/access control interface.	10 Lbs.

## OPTIONS

<b>BBU1-12</b>	Battery Back-up - 12 AH @ 12VDC, 1 battery.	8.5 Lbs.
<b>BBU2-12</b>	Battery Back-up - 12 AH @ 24VDC, 2 batteries.	17 Lbs.
<b>PC</b>	Power Cord - Six foot, grounded line cord with NEMA 5-15P plug end.	0.7 Lbs
<b>TS1</b>	Single Tamper Switch - Monitors enclosure lid.	0.2 Lbs.
<b>TS2</b>	Dual Tamper Switches - Monitor lid & enclosure bottom tamper.	0.3 Lbs.

## ACCESSORIES

<b>500259</b>	Interlock Logic Board. Accessory Controller board with 4 independently triggerable 12/24VDC DPDT relays. Facilitates interlock sequencing of 2 to 3 magnetically locked doors. Self-adhesive tape mount. Consult factory for required system components based on desired interlock operation.	0.4 Lbs.
---------------	---	----------

## Power Supply Maximum Lock Capacity Chart

OUTPUT VOLTAGE	MAX LOAD	LOCKING DEVICE					
		1300	2511	2011/3000	2268-10	3006	3101C
12VDC	6A	6	15	15	10	13	12
24VDC	6A	12	28	28	17	22	22
<b>RATINGS PER LOCK</b>		850mA@12V 450mA@24V	381mA@12V 205mA@24V	374mA@12V 210mA@24V	583mA@12V 335mA@24V	426mA@12V 262mA@24V	456mA@12V 263mA@24V



5224

### 5200 Series Open Transformers

MODEL	PRODUCT	WEIGHT
<b>5212</b>	Open Transformer, 120/12 VAC, 2 Amp	2.5 Lbs.
<b>5213</b>	Open Transformer, 120/12 VDC, 2 Amp	2.5 Lbs.
<b>5224</b>	Open Transformer, 120/24 VAC, 2 Amp	2.5 Lbs.
<b>5225</b>	Open Transformer, 120/24 VDC, 2 Amp	2.5 Lbs.



5324

### 5300 Series Plug-In Transformers

MODEL	PRODUCT	WEIGHT
<b>5312</b>	Plug-in Transformer, 120/12 VAC, 3 Amp	2 Lbs.
<b>5313</b>	Plug-in Transformer, 120/12 VDC, 3 Amp	2 Lbs.
<b>5324</b>	Plug-in Transformer, 120/24 VAC, 1.5 Amp	2 Lbs.
<b>5325</b>	Plug-in Transformer, 120/24 VDC, 1.5 Amp	2 Lbs.



5400

### 5400 Series Battery Back-Up Power Supply

MODEL	PRODUCT	WEIGHT
<b>5400</b>	Power Supply, 1 Amp @ 12VDC only, with 4 AH battery back-up and charger.	6 Lbs.

## Wire Size Selection Charts

Load Current At 24V							
WIRE RUN (FT)	0.25A	0.5A	0.75A	1A	1.25A	1.5A	2A
<b>100</b>	18	18	18	18	16	16	14
<b>150</b>	18	18	16	16	14	14	12
<b>200</b>	18	18	16	14	14	12	12
<b>250</b>	18	16	14	14	12	12	12
<b>300</b>	18	16	14	12	12	12	-
<b>400</b>	18	14	12	12	-	-	-
<b>500</b>	16	14	12	-	-	-	-
<b>750</b>	14	12	-	-	-	-	-
<b>1000</b>	14	-	-	-	-	-	-

Load Current At 12V							
WIRE RUN (FT)	0.25A	0.5A	0.75A	1A	1.25A	1.5A	2A
<b>100</b>	18	18	16	14	14	12	12
<b>150</b>	18	16	14	12	12	12	-
<b>200</b>	16	14	12	12	-	-	-
<b>250</b>	16	14	12	-	-	-	-
<b>300</b>	16	12	12	-	-	-	-
<b>400</b>	14	12	-	-	-	-	-
<b>500</b>	14	-	-	-	-	-	-
<b>750</b>	12	-	-	-	-	-	-
<b>1000</b>	-	-	-	-	-	-	-

## 6000 Series Monitor Panels



6010



6020

6000 Monitor Panels provide bi-color LED's, red/green, operating on 12 or 24 VDC. Mounted on brushed stainless steel US32D switch plate.

MODEL	PRODUCT	WEIGHT
<b>6010</b>	One Bi-Color LED, Red/Green, 12/24VDC	.2 Lbs.
<b>6020</b>	Two Bi-Color LED's, Red/Green, 12/24VDC	.3 Lbs.

## OPTIONS

<b>DBL-AUD</b>	Two Gang Plate with Audible Sounder - 1-28VDC.
<b>NR</b>	Narrow Plate - 1-3/4" wide, substitute.
<b>SF</b>	Special Finishes - Standard finish US32D. See page 52.

## 6000 Series Pushbuttons



6115



6125

6000 Series controls provide a popular selection of request to exit (REX) controls in multiple switching configurations. Monitoring is accomplished with optional illuminated or audible indicators. Standard finish - Brushed Stainless Steel US32D. Standard button color - Green. All switches SPDT contacts.



6135



6145

MODEL	PRODUCT	WEIGHT
<b>6115M</b>	One Pushbutton, 1 Gang, Momentary	.3 Lbs.
<b>6115A</b>	One Pushbutton, 1 Gang, Alternate Action	.3 Lbs.
<b>6125M</b>	Two Pushbuttons, 1 Gang, Momentary	.4 Lbs.
<b>6125A</b>	Two Pushbuttons, 1 Gang, Alternate Action	.4 Lbs.
<b>6135M</b>	Three Pushbuttons, 1 Gang, Momentary	.5 Lbs.
<b>6135A</b>	Three Pushbuttons, 1 Gang, Alternate Action	.5 Lbs.
<b>6145M</b>	Four Pushbuttons, 2 Gang, Momentary	.6 Lbs.
<b>6145A</b>	Four Pushbuttons, 2 Gang, Alternate Action	.6 Lbs.

## OPTIONS

<b>AUD</b>	Audible Sounder - 1-28VDC (Requires DBL option).
<b>DBL</b>	Two Gang Plate - 4-9/16" wide, for options.
<b>ILM</b>	Illuminated Pushbutton - Specify 12 or 24VDC (per button).
<b>LED</b>	Bi-Color LED - Red/Green, 12/24VDC.
<b>NR</b>	Narrow Plate - 1-3/4" wide, substitute.
<b>P2</b>	Additional set of SPDT contacts (per button).
<b>SF</b>	Special Finishes - See page 56.
<b>WPC</b>	Weather Proof Cover - For single gang 6115 only.
<b>ATS</b>	Anti-Tamper Switch

## 6000 Series Pushbuttons

6000 Series controls provide a popular selection of request to exit (REX) controls in multiple switching configurations. Monitoring is accomplished with optional illuminated or audible indicators. Standard finish - Brushed Stainless Steel US32D. Standard button color - Red



**6210**  
1-5/8" Dia.  
Plastic  
Red Button



**6231**  
1-5/8" Dia.  
Plastic  
Red Button  
Marked  
EXIT



**6266**  
1-1/2"  
Latching  
Red Button  
Twist Reset



**6267**  
1-1/2"  
Latching  
Red Button  
Key Reset



**6268**  
1-5/8" Dia.  
Latching  
Red Button  
Key Reset  
Marked  
LOCKDOWN

MODEL	PRODUCT	WEIGHT
<b>6210</b>	Palm Switch, A-A, SPDT	.4 Lbs.
<b>6220</b>	Palm Switch, A-A, DPDT	.4 Lbs.
<b>6230</b>	Palm Switch, MOM, FORM Z	.4 Lbs.
<b>6211</b>	Palm Switch, marked "EXIT", A-A, SPDT	.4 Lbs.
<b>6221</b>	Palm Switch, marked "EXIT", A-A, DPDT	.4 Lbs.
<b>6231</b>	Palm Switch, marked "EXIT", MOM, FORM Z	.4 Lbs.
<b>6266</b>	Latching Palm Switch, Twist Reset, FORM Z	.4 Lbs.
<b>6267</b>	Latching Palm Switch, Key Reset, FORM Z	.4 Lbs.
<b>6268</b>	Latching Palm Switch, Key Reset, marked "LOCKDOWN", FORM Z	.4 Lbs.

## OPTIONS

<b>AUD</b>	Audible Sounder - 1-28VDC (Requires DBL option).
<b>DBL</b>	Two Gang Plate - 4-9/16" wide, for options.
<b>LED</b>	Bi-Color LED - Red/Green, 12/24VDC.
• <b>NR</b>	Narrow Plate - 1-3/4" wide, substitute.
<b>SF</b>	Special Finishes - See page 56.
# <b>GRN</b>	Green Button
<b>ATS</b>	Anti-Tamper Switch
<b>CB-NO</b>	Contact Block - 6230, 6231, 6266, 6267 and 6268 may have one additional set of momentary NO or NC contacts.
<b>CB-NC</b>	

## NOTES:

- Not available on Model 6268
- # Not available on Models 6266, 6267 and 6268

<b>A-A</b>	Alternate Action (Maintained)
<b>MOM</b>	Momentary Action
<b>SPDT</b>	Single Pole Double Throw
<b>DPDT</b>	Double Pole Double Throw
<b>FORM Z</b>	Single Pole Double Throw, Double Break



## 6000 Series Pushbuttons

MODEL	PRODUCT	WEIGHT
6270	Pushbutton, 2" Sq. MOM, SPDT, 12/24VDC	.4 Lbs.
6275	Pushbutton, 3/8" Dia. 1-60 Sec. PTD, FORM Z	.3 Lbs.
6285	RGB Ring LED Illuminated Push Button, Dual Mode MOM or A-A, FORM Z, 12/24 VDC	.3 Lbs.
6290	Palm Switch, 1-5/8" Dia. FORM Z, PTD 30 Sec. Min., NFPA 101, 2003 Paragraph 7-2.1.6.2	.4 Lbs.
6291	Palm Switch, 1-5/8" Dia. FORM Z, PTD 30 Sec. Min., City of Denver Policy Statement 1994, Paragraph 4	.5 Lbs.
6300	Audible, 6-28VDC	.4 Lbs.



**6270**  
2" Square  
Plastic  
Green Button  
Black EXIT  
Illuminated



**6275**  
3/8" Dia.  
SST Button  
With Pneumatic  
Time Delay



**6285**  
14mm Dia.  
SST Button  
Ring LED Illuminated  
IP65 Sealed  
Vandal Resistant



**6290**  
1-5/8" Dia.  
Plastic  
Red Button Marked  
EXIT  
NFPA 101 Code



**6291**  
1-5/8" Dia.  
Plastic Red  
Button Marked  
UNLOCK DOOR  
Denver Code



**6300**  
1-3/4" Dia.  
Audible  
90 dB @ 30 cm

### OPTIONS

<b>LED</b>	Bi-Color LED - Red/Green, 12/24VDC
<b>NR</b>	Narrow Plate - 1-3/4" wide. Available on 6275, 6280, 6282, and 6290 only.
<b>SF</b>	Special Finishes - Standard finish US32D. See page 56.
<b>ATS</b>	Anti-Tamper Switch

### NOTES:

<b>A-A</b>	Alternate Action (Maintained)
<b>MOM</b>	Momentary Action
<b>SPDT</b>	Single Pole Double Throw
<b>DPDT</b>	Double Pole Double Throw
<b>FORM Z</b>	Single Pole Double Throw, Double Break
<b>PTD</b>	Pneumatic Time Delay
<b>SST</b>	Stainless Steel

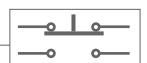



6171



6172



6173



6174



6175



6176

## 6170 Series Weatherproof Pushbutton

Commercial grade weatherproof pushbutton. Button is 3/4" diameter white thermoplastic raised dome, rated IP68 water-tight (up to 1 meter), IP64 moisture-proof, and IP64 dust-tight. Single gang plate, includes weatherproof faceplate gasket and tamper-resistant faceplate screws. Green LED backlight button on all models, field selectable 12/24 VDC. All models are momentary-action SPDT-Double Break (FORM Z)

Contact Rating: 3 A @ 115VAC

Operating temperature rating: -67°F to +185°F



MODEL	PRODUCT	WEIGHT
6171	Blank Faceplate	.3 Lbs.
6172	Faceplate Silkscreened "EXIT"	.3 Lbs.
6173	Faceplate Silkscreened "EXIT/SALIDA"	.3 Lbs.
6174	Faceplate Silkscreened "EXIT/SORTIE"	.3 Lbs.
6175	Faceplate Silkscreened "PUSH TO UNLOCK"	.3 Lbs.
6176	Faceplate Silkscreened "PUSH TO OPEN"	.3 Lbs.

## OPTIONS

- BBX** Weatherproof Surface Back Box - 2<sup>5</sup>/<sub>8</sub>" deep
- CSF** Custom Silkscreened Faceplate - Consult factory for price and delivery
- SF** Special Finish Faceplate - US32D standard, see page 56 for other finishes
- ATS** Anti-Tamper Switch



EX

**Illuminated Signage**



## 6500 Series High Visibility Pushplates

6500 Series Pushplates are double-gang, heavy duty egress controls machined from solid aluminum featuring electroluminescent illuminated signage. Multiple switching configurations and finishes are available. All models are low profile (13/16" projection from wall) and tamper resistant. *Consult factory for custom signage.*

Standard finish - Satin Aluminum US28.

Current Draw: 30 mA @ 12 or 24VDC

PTD Contact Rating: 10 A @ 125VAC / All Others: 6 A @ 125VAC

Weight: 1.5 Lbs.

### MODEL SELECTION

**65 - XX - XXX - XX - \***

**Specify Operating Voltage**

**12** 12 VDC

**24** 24 VDC

**Specify Switch Format**

**MO** MOMENTARY SPDT SWITCH

**AA** ALTERNATE ACTION SPDT SWITCH

**PTD** PNEUMATIC TIME DELAY  
2-60 SEC, SPDT FORM Z SWITCH



**Specify Signage**

**EX** "EXIT"

**PE** "PUSH TO EXIT"

**OP** "OPEN"

**PO** "PUSH TO OPEN"

**SA** "SALIDA" SPANISH (EXIT)

**SO** "SORTIE" FRENCH (EXIT)

**ES** "EXIT/SALIDA" ENGLISH & SPANISH

**EF** "EXIT/SORTIE" ENGLISH & FRENCH

**AB** "ABRA" SPANISH (OPEN)

**OU** "OUVREZ" FRENCH (OPEN)

**OA** "OPEN/ABRA" ENGLISH & SPANISH

**OZ** "OPEN/OUVREZ" ENGLISH & FRENCH

**6500 Series**

### \* OPTIONS

**DP** DPDT Switch. Not available with PTD option.

**SF** Special Finishes - US28 standard. US3, US4, US10, US13, US10B, US19, US26 available.

**CS** Custom Signage - Please consult factory.

Lamp illuminates indefinitely. Optimal brightness up to 10,000 hours (continuous usage). Field replacements are available, consult factory.

# Halo-Lighted Piezo REX Push Button



## 6610 / 6610E Halo-Lighted Piezo REX Push Button

DynaLock's 6610/6610E is a heavy duty single gang, halo-lighted piezo REX push button. Features include selectable illumination (green/red/no illumination), adjustable 1-60 second output timer, Form C relay outputs and single finger touch activation. This illuminated switch is non-sparking, non-magnetic and corrosion resistant, making it a perfect fit for industrial, high risk environments as well as access control systems and direct door control.



6610

MODEL	PRODUCT	FINISH	WEIGHT
<b>6610</b>	Single Gang, Blank Faceplate, 10-24VDC	US32D	.7 Lbs.
<b>6610E</b>	Single Gang, "Push To Exit" Faceplate, 10-24VDC	US32D	.7 Lbs.



6610E

## 6620 / 6620E Piezo Electric Switch

DynaLock's 6620/6620E is a heavy duty narrow, halo-lighted piezo REX push button. Features include selectable illumination (green/red/no illumination), Form C relay outputs and single finger touch activation. This illuminated switch is non-sparking, non-magnetic and corrosion resistant, making it a perfect fit for industrial, high risk environments as well as access control systems and direct door control.



6620

MODEL	PRODUCT	FINISH	WEIGHT
<b>6620</b>	Narrow, Blank Faceplate, 10-24VDC	US32D	.5 Lbs.
<b>6620E</b>	Narrow, "Exit" Faceplate, 10-24VDC	US32D	.5 Lbs.



6620E

ACCESSORIES		WEIGHT
<b>66BB-10</b>	Surface Back Box, Single Gang	US32D 1.1 Lbs.
<b>66BB-20</b>	Surface Back Box, Narrow	US32D .8 Lbs.

OPERATING VOLTAGE	CURRENT INPUT	CURRENT INPUT	VOLTAGE OUTPUT
10-24VDC	15mA @ 24VDC (STANDBY)	140mA @ 24VDC (MAX)	FORM C RELAY (5A @ 125V)





**Single Gang**



**Single Gang Recessed**



**Narrow**



**Narrow Recessed**

## 6700/6800 Series Pushplates

6700 & 6800 Series Pushplates are heavy duty egress controls machined from solid aluminum with engraved "PUSH TO EXIT" signage. Multiple switching configurations and finishes are available. Narrow recessed models are specifically designed for installation in aluminum store front frames, requiring minimal cut-out/preparation. All momentary models feature "all active" operation. Consult factory for special engraving.

Standard finish - Satin Aluminum US28

PTD Contact Rating: 10 A @ 125VAC

All Others: 6 A @ 125VAC

MODEL	PRODUCT	WEIGHT
<b>6700</b>	Single Gang 1-60 Sec. PTD, FORM Z	.7 Lbs.
<b>6710</b>	Single Gang A-A, SPDT	.7 Lbs.
<b>6720</b>	Single Gang A-A, DPDT	.8 Lbs.
<b>6730</b>	Single Gang MOM, SPDT	.7 Lbs.
<b>6740</b>	Single Gang MOM, DPDT	.8 Lbs.
<b>6750</b>	Single Gang, Recessed 1-60 Sec. PTD, FORM Z	.8 Lbs.
<b>6751</b>	Single Gang, Recessed A-A, SPDT	.8 Lbs.
<b>6752</b>	Single Gang, Recessed A-A, DPDT	.9 Lbs.
<b>6753</b>	Single Gang, Recessed MOM, SPDT	.8 Lbs.
<b>6754</b>	Single Gang, Recessed MOM, DPDT	.9 Lbs.
<b>6800</b>	Narrow 1-60 Sec. PTD, FORM Z	.6 Lbs.
<b>6810</b>	Narrow A-A, SPDT	.6 Lbs.
<b>6820</b>	Narrow A-A, DPDT	.7 Lbs.
<b>6830</b>	Narrow MOM, SPDT	.6 Lbs.
<b>6840</b>	Narrow MOM, DPDT	.7 Lbs.
<b>6850</b>	Narrow, Recessed 1-60 Sec. PTD, FORM Z	.7 Lbs.
<b>6851</b>	Narrow, Recessed A-A, SPDT	.7 Lbs.
<b>6852</b>	Narrow, Recessed A-A, DPDT	.8 Lbs.
<b>6853</b>	Narrow, Recessed MOM, SPDT	.7 Lbs.
<b>6854</b>	Narrow, Recessed MOM, DPDT	.8 Lbs.

## OPTIONS

**SF** Special Finishes - US28 standard. US3, US4, US10, US13, US10B, US19, US26 available.

## NOTES:

**A-A** Alternate Action (Maintained)  
**MOM** Momentary Action  
**SPDT** Single Pole Double Throw  
**DPDT** Double Pole Double Throw  
**PTD** Pneumatic Time Delay  
**FORM Z** Single Pole Double Throw, Double Break





**Single Gang**



**Single Gang Recessed**



**Narrow**



**Narrow Recessed**

## 6705/6805 Series Handicapped Pushplates

6705 & 6805 Series Handicapped Pushplates are heavy duty egress controls machined from solid aluminum with blue engraved handicapped symbol. Multiple switching configurations and finishes are available. Narrow recessed models are specifically designed for installation in aluminum store front frames, requiring minimal cut-out/preparation. All momentary models feature "all active" operation. Consult factory for special engraving. Standard finish - Satin Aluminum US28  
PTD Contact Rating: 10 A @ 125VAC  
All Others: 6 A @ 125VAC

MODEL	PRODUCT	WEIGHT
<b>6705</b>	Single Gang 1-60 Sec. PTD, FORM Z	.7 Lbs.
<b>6715</b>	Single Gang A-A, SPDT	.7 Lbs.
<b>6725</b>	Single Gang A-A, DPDT	.8 Lbs.
<b>6735</b>	Single Gang MOM, SPDT	.7 Lbs.
<b>6745</b>	Single Gang MOM, DPDT	.8 Lbs.
<b>6755</b>	Single Gang, Recessed 1-60 Sec. PTD, FORM Z	.8 Lbs.
<b>6765</b>	Single Gang, Recessed A-A, SPDT	.8 Lbs.
<b>6775</b>	Single Gang, Recessed A-A, DPDT	.9 Lbs.
<b>6785</b>	Single Gang, Recessed MOM, SPDT	.8 Lbs.
<b>6795</b>	Single Gang, Recessed MOM, DPDT	.9 Lbs.
<b>6805</b>	Narrow 1-60 Sec. PTD, FORM Z	.6 Lbs.
<b>6815</b>	Narrow A-A, SPDT	.6 Lbs.
<b>6825</b>	Narrow A-A, DPDT	.7 Lbs.
<b>6835</b>	Narrow MOM, SPDT	.6 Lbs.
<b>6845</b>	Narrow MOM, DPDT	.7 Lbs.
<b>6855</b>	Narrow, Recessed 1-60 Sec. PTD, FORM Z	.7 Lbs.
<b>6865</b>	Narrow, Recessed A-A, SPDT	.7 Lbs.
<b>6875</b>	Narrow, Recessed A-A, DPDT	.8 Lbs.
<b>6885</b>	Narrow, Recessed MOM, SPDT	.7 Lbs.
<b>6895</b>	Narrow, Recessed MOM, DPDT	.8 Lbs.

## OPTIONS

**SF** Special Finishes - US28 standard. US3, US4, US10, US13, US10B, US19, US26 available.

## NOTES:

- A-A** Alternate Action (Maintained)
- MOM** Momentary Action
- SPDT** Single Pole Double Throw
- DPDT** Double Pole Double Throw
- PTD** Pneumatic Time Delay
- FORM Z** Single Pole Double Throw, Double Break





**Double Gang**



**Double Gang Recessed**

## 6901 Series Pushplates

DynaLock Specialty Exit Controls provide "out of the box" solutions to meet specific codes or mandates governing egress requirements within a facility, municipality or region.

6901 Series are tamper resistant, heavy duty double gang pushplates machined from solid aluminum. All models with "PUSH TO EXIT" signage engraved. Lettering is black with 1/8" stroke and 1" height (minimum).

All momentary models feature "all active" operation.

Standard finish - Satin Aluminum US28

PTD Contact Rating: 10 A @ 125VAC / UL

All Others: 6 A @ 125VAC / UL

MODEL	PRODUCT	WEIGHT
<b>6901</b>	Double Gang 1-60 Sec. PTD, FORM Z	1.3 Lbs.
<b>6911</b>	Double Gang A-A, SPDT	1.3 Lbs.
<b>6921</b>	Double Gang A-A, DPDT	1.4 Lbs.
<b>6931</b>	Double Gang MOM, SPDT	1.3 Lbs.
<b>6941</b>	Double Gang MOM, DPDT	1.4 Lbs.
<b>6951</b>	Double Gang, Recessed 1-60 Sec. PTD, FORM Z	1.4 Lbs.
<b>6961</b>	Double Gang, Recessed A-A, SPDT	1.4 Lbs.
<b>6971</b>	Double Gang, Recessed A-A, DPDT	1.5 Lbs.
<b>6981</b>	Double Gang, Recessed MOM, SPDT	1.4 Lbs.
<b>6991</b>	Double Gang, Recessed MOM, DPDT	1.5 Lbs.

## OPTIONS

**SF** Special Finishes - US28 standard. US3, US4, US10, US13, US10B, US19, US26 available.

## NOTES:

- A-A** Alternate Action (Maintained)
- MOM** Momentary Action
- SPDT** Single Pole Double Throw
- DPDT** Double Pole Double Throw
- PTD** Pneumatic Time Delay
- FORM Z** Single Pole Double Throw, Double Break

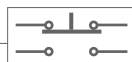



6335



6337

## 6335 Series Pushbuttons

Station controls furnished in compact, surface-mounted enclosures. Designed to be concealed under a desk or in a similar installation.  
Dimensions: 1"H x 2-1/4"W x 2"D

MODEL	PRODUCT	WEIGHT
<b>6335</b>	(1) Pushbutton, SPDT Maintained Contact	.4 Lbs.
<b>6336</b>	(1) Pushbutton, SPDT Momentary Contact	.4 Lbs.
<b>6337</b>	(2) Pushbuttons, SPDT Maintained Contacts	.5 Lbs.
<b>6338</b>	(2) Pushbuttons, SPDT Momentary Contacts	.5 Lbs.

## OPTIONS

<b>P2</b>	Upgrade to DPDT contacts (6335/6336 only).
<b>P4</b>	Upgrade to DPDT contacts (6337/6338 only).
<b>ILM</b>	Illuminated Pushbutton - Specify 12 or 24VDC (6335/6336 only).
<b>ILM2</b>	Illuminated Pushbuttons - Specify 12 or 24VDC (6337/6338 only).

## 6350 Series Monitor Station

Four zone monitor station is designed to work in conjunction with up to four Series 3101B delay egress systems. Each 6350 is mounted on a standard two gang plate and includes four bi-color LED's and one sounder with mute switch, to visually and audibly signal delay egress status at a remote location. For full functioning all locks connected to the 6350 require the Dynastat option.



6350

MODEL	PRODUCT	WEIGHT
<b>6350</b>	Four Zone Monitor Station for Delay Egress Systems. Furnished with a 5312 Transformer.	3.6 Lbs.

## 6370 Series Control & Monitor Station

Single zone control & monitor station is designed for use with a separate, component style delay egress system. It includes audible and visual monitoring of lock and delay egress status. Reset and release functions are provided by keyswitch. The 6370 is mounted on a standard two gang plate.



6370

MODEL	PRODUCT	WEIGHT
<b>6370</b>	Single Zone Control & Monitor Station for Delay Egress Systems.	1.5 Lbs.

# Passive Infrared Request-To-Exit Sensor



## 6420 Series Passive Infrared Sensor



The DynaLock Series 6420 passive infrared Request-To-Exit sensor detects the differential between a human body and the floor. Featuring a dual-pyroelectric design, for increased stability against external light, the 6420's pyramid-shaped detection field is positionable from straight-down verticle to 35° in front of the door and special circuitry provodes high-immunity to RFI and other electrical noise. Two, built-in SPDT dry relay output contacts are rated for 1 Amp @ 30VDC and an adjustable timer may be set for 0.25 to 60 seconds of relay hold time. Additionally, the output relay's mode may be set for fail-safe or fail-secure operation and an on-board LED indicator may be set to illuminate during relay hold time.

The 6420 accepts 12 to 24 VAC/VDC input power and is designed for wall, ceiling or door frame mounting. It is ideally suited for access control, lock release, alarm shunting and automatic door operation.

MODEL	PRODUCT	WEIGHT
6420	Passive Infrared Request-To-Exit Sensor	.5 Lbs.

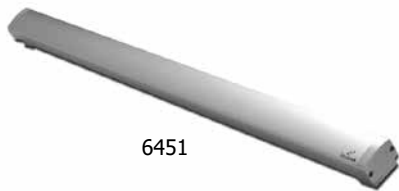

6451



NYC MEA  
#23-92-E

**CSFM**



PTE OPTION

## 6451 Series Exit Sensor Bar

Non-latching, non-handed exit sensor bar for use with electromagnetic lock to provide immediate, single-motion egress. Non-mechanical optical sensors require no adjustment and provide DPDT output contacts. A mechanical switch is also built-in as a redundant back-up release. Available in three standard lengths, easily cut in the field for custom width doors. Minimum travel, positive stops and metal end caps provide true vandal and wear resistance. Furnished with power transfer cable from door to frame.

Not to be used with electric deadbolt locks.

Current Draw: 105 mA @ 12/24 VDC/VAC

Relay: DPDT / 5 Amps @ 30 Volts

MODEL	PRODUCT	WEIGHT
<b>6451-36</b>	Exit Sensor Bar, For 36" Door, US28 Finish	4.8 Lbs.
<b>6451-42</b>	Exit Sensor Bar, For 42" Door, US28 Finish	5.5 Lbs.
<b>6451-48</b>	Exit Sensor Bar, For 48" Door, US28 Finish	6.1 Lbs.

NOTE: All models for doors with 5/8" or less frame stop.

Actual bar length is 2" less than width of door x 2-3/8"H x 2-7/16"D

Distance between mounting holes is 2-3/4" less than width of door.

## OPTIONS

- CAB64** Cable Kit - 16 ft., 8 cond., to facilitate wiring.
- TSB** Mounting pads modified to match Securitron® TSB mounting footprint.
- SF** Special Finishes - Standard finish US28. Also available in anodized dark bronze (US10B) or satin brass (US4), to match door trim.
- WDK** Wood Door Kit - (4) #10 sex nuts and bolts for wood doors 1-3/4" to 2-1/4" thick.
- DMB** Dummy Bar - Less circuit boards.
- PTE** PUSH TO EXIT Engraved Signage - 1" high, 1/8" stroke, red filled.
- CLC** Custom Length Cut - Specify desired overall finished length of Exit Sensor Bar.\*

\* TIP: To calculate Custom Length Cut, subtract 3/4" from the distance between door stops (D).



## 7000 Series Keyswitches

Keyswitches may be used to control electric locks, shunt or activate security panels, consoles or any similar requirements. The assembly is supplied with face plate, bracketry, cylinder locknut and one or two switches depending on model ordered. The user typically supplies the mortise cylinder and cam when master keying a system. Models 7050 & 7051 do not require a cylinder.

Switch contacts rated 6 Amps @ 125VAC and are available momentary or maintained, SPDT or DPDT. Switch assembly requires 1-1/2" depth clearance and is shipped on single, double or narrow gang plates. Standard Finish: US32D

Cylinder Requirements: 1-1/8" or 1-1/4" Mortise Cylinder with "bat" type cam.



7001xCYL



7001xNRxCYL



7050

MODEL	PRODUCT	WEIGHT
<b>7001</b>	Maintained, (1) SPDT	.5 Lbs.
<b>7002</b>	Momentary, (1) SPDT	.5 Lbs.
<b>7003</b>	Maintained, (2) SPDT	.5 Lbs.
<b>7004</b>	Momentary, (2) SPDT	.5 Lbs.
<b>7005</b>	Momentary/Maintained, 1 Each SPDT	.5 Lbs.
<b>7021</b>	Maintained, (1) DPDT	.6 Lbs.
<b>7022</b>	Momentary, (1) DPDT	.6 Lbs.
<b>7023</b>	Maintained, (2) DPDT	.6 Lbs.
<b>7024</b>	Momentary, (2) DPDT	.6 Lbs.
<b>7025</b>	Momentary/Maintained, 1 Each DPDT	.7 Lbs.
<b>7035</b>	Elec. Time Delay, 0-60 Sec. SPDT, 2 Gang	1 Lbs.
<b>7050</b>	3101C Type, Momentary/Maintained	.5 Lbs.
<b>7051</b>	3101C Type, Momentary/Momentary	.5 Lbs.
<b>7054</b>	For Use With 3101C-TJ101-G2 Lock	.5 Lbs.

### OPTIONS

- \* **ATS** Anti-Tamper Switch
- **AUD** Audible Sounder - 1-28VDC (Requires DBL option).
- **CYL** Mortise Cylinder - 1-1/4" long w/cam, 2 keys.
- DBL** Two Gang Plate - 4-9/16" wide, for options.
- KEY** Key, Extra (Order with CYL option)
- ~ **LED** Bi-Color LED - Red/Green, 12/24VDC.
- NR** Narrow Plate - 1-3/4" wide, substitute.
- ~ **PBA** Pushbutton - 6115A type (Requires DBL option).
- ~ **PBM** Pushbutton - 6115M type (Requires DBL option).
- ~ **SF** Special Finishes - Standard finish US32D. See page 56.
- WPC** Weatherproof Cover - Single Gang Only.

- Notes:
- \* Not available with NR or WPC Options.
  - Not available with NR or WPC Options, or on Model 7035.
  - All cylinders keyed alike.
  - ~ Not available with WPC Option.

### 7075 Series Break Glass Exit Stations



7075

Break glass assembly provides auxiliary method of releasing egress doors in an emergency situation. The assembly may be ordered in three versions: standard, standard with LED indicator or standard with audible.

Size: 6-3/4" x 4-1/2"

Contacts: SPDT-DB (FORM Z), MOM rated 6 Amps @ 125VAC

Furnished with 5 spare glass lenses.

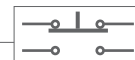

MODEL	PRODUCT	WEIGHT
<b>7075</b>	Break Glass, Standard	.9 Lbs.
<b>7076</b>	Break Glass, with Bi-Color LED, Red/Green, 12/24VDC	.9 Lbs.
<b>7077</b>	Break Glass, with Audible Sounder, 1-28VDC, 1-28VDC	1.1 Lbs.
<b>7078</b>	Spare Contact Block, SPDT	.3 Lbs.
<b>7079</b>	Spare Lenses, 5 Pk.	.1 Lbs.



7080

### 7080 Series Adjustable Time Delay Module

Compact, in-line time delay module provides an adjustable relock delay for an electric lock controlled by a momentary normally-closed access/egress device.

Size: 5/8"W x 2"L x 9/16"D

Input Power: 12-30 VAC/VDC, Contacts: SPDT rated 1 Amp @ 30VDC

Delay Adjustment Range: 0-60 Seconds

MODEL	PRODUCT	WEIGHT
<b>7080</b>	Adjustable Time Delay Module	.3 Lbs.



7086

### 7086 Series Programmable Digital Timer

365 day/24 hour digital timer provides automated control of electric locks. Programmable for up to 50 weekly/daily events and 10 holidays. Operates on 12 or 24 VAC/VDC @ 0.05A.

Size: 3"W x 5.25"L x 1"D

Contacts: SPDT rated 10 Amps @ 120VAC

MODEL	PRODUCT	WEIGHT
<b>7086</b>	Programmable Digital Timer	.4 Lbs.



7088

### 7088 Prewired Rectifier

MODEL	PRODUCT	WEIGHT
<b>7088</b>	1 Amp Prewired Rectifier Module	.2 Lbs.





**MODEL 7300**



**MODEL 7350**



**MODEL 7400**



**MODEL 7450**

## 7300/7350 Stand Alone Digital Keypads

These rugged, vandal resistant all metal piezoelectric keypads are designed for access solutions in harsh industrial, institutional and commercial environments. A user-friendly setup menu makes programming and use a very simple task for end-user's. Both feature audio and visual recognition as well as multiple inputs and outputs for a wide array of functions, auxiliary modes and 500 user codes with three access levels for each. Includes keypad, installation kit, 3 foot wiring cable and a self-adhesive mounting template.

MODEL	PRODUCT	WEIGHT
<b>7300</b>	Single Gang Box Mounting-3x4 Matrix Keypad	1.4 Lbs.
<b>7350</b>	Narrow Mullion Design-2x6 Matrix Keypad	1.2 Lbs.

## 7400/7450 Stand Alone Digital Keypads

These durable, high impact, polycarbonate keypads are designed for access solutions for indoor and outdoor residential, commercial and institutional applications. A user-friendly setup menu makes programming and use very simple for end-user's. Both feature audio and visual recognition, red backlit keys for enhanced visibility as well as multiple inputs and outputs for a wide array of functions, auxiliary modes and 500 user codes with three access levels for each. Includes keypad, installation kit, 3 foot wiring cable and a self-adhesive mounting template.

MODEL	PRODUCT	WEIGHT
<b>7400</b>	Single Gang Box Mounting-3x4 Matrix Keypad	.7 Lbs.
<b>7450</b>	Narrow Mullion Design-2x6 Matrix Keypad	.6 Lbs.

## Common Features - All Models

- 500 User Pin Code Capacity
- 4 to 8 Digit Programmable Pin Codes
- 3 User Levels, 3 Access Levels Per User
- Waterproof and Dust Resistant (Meets IP65)
- Two SPDT Form "C" Relay Outputs
- REX and Auxiliary Inputs
- Two Tri-Color LED and Audible Indicators
- Built-in Optical Back Tamper Sensor
- Operates on 12-24VDC or 16-24VAC Input
- Ten Programmable Auxiliary Modes

## 7500 Series Standalone Keypad / Prox Card Reader



MODEL #7500

This advanced, stand-alone PIN & proximity controller is designed for access solutions in a wide array of environments from high-traffic commercial to harsh industrial applications. Features such as "code search" and 10 auxiliary modes makes this controllers programming very user friendly. Wiring connections are made easy with the 7500's removable terminal blocks and dual output contacts. Other features include audio & video recognition, three access/security levels with 500 user codes, as well as a built-in automatic heater application. Includes keypad, installation kit and a self-adhesive mounting template.

MODEL	PRODUCT	WEIGHT
7500	Standalone Keypad / Prox Card Reader	1.5 Lbs.



MODEL #7551

## ACCESSORIES

- 7551** Read-Only 125KHz Clamshell Proximity Card (White-Unprinted)
- 7561** Read-Only 125KHz Proximity Tag (Ring Design-Gray)
- 7571** Read-Only 125KHz Proximity Tag (Wafer Design-Gray)



MODEL #7561



MODEL #7571

# Standard Slope Front Consoles



8006SF

## 8000SF Series Standard Slope Front Consoles

Series 8000SF Consoles are designed to control and monitor most any type electric lock and may be ordered with up to 12 stations. An external source of power similar to DynaLock power supplies shown on pages 25 thru 27 is required. Slope front consoles larger than 12 stations or that may have an internal power source are considered custom. Refer to the custom console section pages 43 and 44.

8000SF Consoles are furnished in a black front metal panel with blue metal sides. Available in 4 different size enclosures from 1 to 12 stations. Included features on each station:

- One red LED indicator.

- One green LED indicator.

- One SPDT toggle switch (Specify momentary or maintained contact).

All consoles require external power. Specify operating voltage 12 or 24 VDC when ordering.

MODEL	PRODUCT
<b>8001SF</b>	1 Station Slope Front Console
<b>8002SF</b>	2 Station Slope Front Console
<b>8003SF</b>	3 Station Slope Front Console
<b>8004SF</b>	4 Station Slope Front Console
<b>8005SF</b>	5 Station Slope Front Console
<b>8006SF</b>	6 Station Slope Front Console
<b>8007SF</b>	7 Station Slope Front Console
<b>8008SF</b>	8 Station Slope Front Console
<b>8009SF</b>	9 Station Slope Front Console
<b>8010SF</b>	10 Station Slope Front Console
<b>8011SF</b>	11 Station Slope Front Console
<b>8012SF</b>	12 Station Slope Front Console

## ACCESSORIES

**LK** Label Kit - Includes engraved nameplates to number stations 1 thru 12 and 5 nameplates to label functions "SECURE", "UNSECURE", "CLOSED", "OPEN" and "RELEASE" as required.

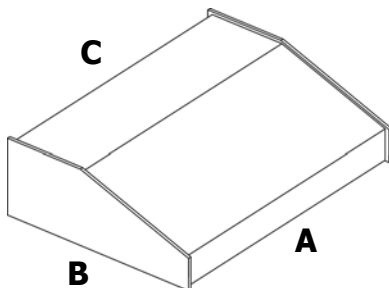

MODEL "SF"	A	B	C
<b>8001-8003</b>	<b>6.5"</b>	<b>8.3"</b>	<b>3.0"</b>
<b>8004-8005</b>	<b>10.0"</b>	<b>8.3"</b>	<b>3.0"</b>
<b>8006-8007 8008</b>	<b>14.0"</b>	<b>8.3"</b>	<b>3.0"</b>
<b>8009-8010 8011-8012</b>	<b>17.0"</b>	<b>8.3"</b>	<b>3.0"</b>



Universal Control  
Module

## 8000 Series Custom Consoles

Consoles are specially fabricated to customer requirements. The factory must be consulted for specific pricing, delivery and performance specifications. Consoles, regardless of configuration, share common monitoring and control functions. DynaLock has developed a universal control module to perform these functions. It satisfies the majority of applications, keeps initial cost to a minimum and facilitates service.

**Please refer to page 49 - "8000 Series Quotation Questionnaire" before contacting Sales for a price quotation.**



8005CSF

## 8000CSF Series

CSF - Custom Slope Front Consoles are capable of performing additional control and monitoring functions, with increased station capacity beyond the standard 8000SF Series on page 47.



8030DT

## 8000DT Series

DT - Desk Top Consoles are furnished in black cabinets with a brushed aluminum finish front panel. Cabinet size and shape are configured to reflect console function.



8012WM

## 8000RM and 8000WM Series

RM - Rack Mount and WM - Wall Mount Consoles are furnished on a brushed aluminum finish panel, with or without back box.

## 8000 Series Quotation Questionnaire

**Please complete the following questionnaire and fax it to 860-585-0338 for a prompt price and delivery quotation. Refer to 8000 Series Brochure for complete explanation of console terminology, found at [www.dynalock.com](http://www.dynalock.com).**

Style of Console:  CSF  
 RM  
 DT  
 WM

Type of electric lock(s) to be controlled:  
 Electromagnetic  With delay egress  
 Electric Deadbolt  Fail-Safe  Fail-Secure  
 Electric Strike  Fail-Safe  Fail-Secure

Input Voltage:  12V  24V

Number of Stations: \_\_\_\_\_

Locks to be controlled have the following options:  Door Status  Lock Status  Anti-Tamper

Console to:  Control/Monitor  Control Only  Monitor Only

Individual Station Type:  T  TL1  TL2  TL3  L1  L2  L3

Type of Control Switch:  Maintained Contact  Momentary Contact

Light color preferences from top to bottom: (Red, Green, Yellow). (T) \_\_\_\_\_ (M) \_\_\_\_\_ (B) \_\_\_\_\_

Master Alarm Station with Audible (MA):  Yes  No

If Yes Audible Signals:  Door Status (open)  Lock Status (unlocked)  Delay Egress (3101B lock)  
 Standard: Audible will sound when condition occurs and continue until condition is corrected.

Other - Explain: \_\_\_\_\_  
\_\_\_\_\_

Master Alarm Station includes mute switch to silence audible (audible will silence but will be overridden with new alarm condition) and red power "ON" LED.

Master Override:  MOT  MOK  MOC

Master Lockout:  MLT  MLK  MLC

System Description of Operation (please type, using a separate page if necessary):

# Communicating Bathroom System



## 8500 Series Communicating Bathroom Systems

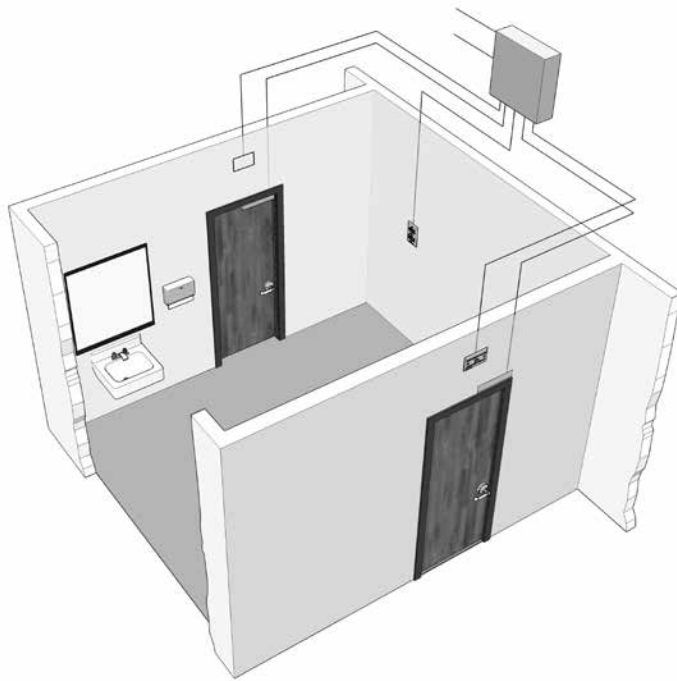

Series 8500 Bathroom Systems provide privacy for the occupant of a single bathroom shared by adjacent rooms. The occupant can lock/unlock all doors using an interior pushbutton. Exterior pushbuttons are located above or adjacent to each door, to provide release of all doors during an emergency. Facilities for fire panel emergency release are also provided. The complete system includes control switches, magnetic locks, power supply, and wiring diagram.

MODEL	PRODUCT	WEIGHT
<b>8500-2</b>	Two Door System - Includes:	22 Lbs.
	(2) 2511-DSM (1) 6115A-CB-ILM-24V	Maglock with door status switch Red pushbutton, SPDT, maintained silk screened "LOCKED WHEN LIT, PRESS TO OPERATE"
	(2) 6115A-EO-ILM-24V	Red pushbutton, SPDT, maintained silk screened "EMERGENCY UNLOCK, OCCUPIED WHEN LIT"
	(1) 5725 (1) 500259 (1) 900274-D	Power supply, 24VDC, 1.5A Interlock Logic Board System Wiring Diagram
<b>8500-3</b>	Three Door System - Includes:	27 Lbs.
	(3) 2511-DSM (1) 6115A-CB-ILM-24V	Maglock with door status switch Red pushbutton, SPDT, maintained silk screened "LOCKED WHEN LIT, PRESS TO OPERATE"
	(3) 6115A-EO-ILM-24V	Red pushbutton, SPDT, maintained silk screened "EMERGENCY UNLOCK, OCCUPIED WHEN LIT"
	(1) 5725 (1) 500259 (1) 900415-B	Power supply, 24VDC, 1.5A Interlock Logic Board System Wiring Diagram



## 9200 Series Door Position Contacts

MODEL	PRODUCT	WEIGHT
9200	Surface mounted magnetic contact, Screw Terminals, SPDT rated 0.25 Amps @ 30VDC.	.1 Lbs.
9225	Surface mounted magnetic contact, Flying Leads, SPDT rated 0.25 Amps @ 30VDC.	.1 Lbs.
9250	Mortise mounted magnetic contact, Screw Terminals SPDT rated 0.25 Amps @ 30VDC.	.2 Lbs.
9275	Mortise mounted roller ball type SPDT rated 4 Amps @ 24VDC.	.3 Lbs.
9280	Mortise mounted roller ball type DPDT rated 4 Amps @ 24VDC.	.3 Lbs.

## 9300 Series Armored Door Cords

MODEL	PRODUCT	WEIGHT
9300	Flexible armored door cord 18" long, less wires.	.2 Lbs.
9350	Flexible armored door cord 18" long with three 24"L wires.	.3 Lbs.



# Available Special Finishes\*



**\*MARKET PRICING APPLIES TO SPECIAL FINISHES\***  
**CONSULT FACTORY FOR CURRENT AVAILABILITY, COST, DELIVERY**  
**AND APPLICABLE MINIMUM LOT CHARGES**

PART NUMBER	FINISHES							
	SATIN ALUMINUM US28	BRIGHT BRASS US3	SATIN BRASS US4	LIGHT BRONZE US10	MEDIUM BRONZE US13	DARK BRONZE US10B	BLACK SATIN US19	BRIGHT CHROME US26
SINGLE MAG. LOCKS	STD	■	■	■	■	■	■	■
SINGLE MAG. LOCKS - TJ	STD	■	■	■	■	■	■	■
DOUBLE MAG. LOCKS	STD	■	■	■	■	■	■	■
DOUBLE MAG. LOCKS -TJ	STD	■	■	■	■	■	■	■
TJ20 AND TJ30 KIT, 4850 SERIES SPECIALITY BRACKETS	STD	■	■	■	■	■	■	■
3500 AND 3600 SERIES CUSTOM LENGTH HOUSING TO 36"	STD	■	■	■	■	■	■	■
3700 AND 3800 SERIES CUSTOM LENGTH TO 72"	STD	NA	NA	NA	NA	NA	NA	NA
3700 AND 3800 SERIES CUSTOM LENGTH HOUSING TO 96"	STD	NA	NA	NA	NA	NA	NA	NA
4000 SERIES TO 14"	STD	■	■	■	■	■	■	■
4000 SERIES TO 36"	STD	■	■	■	■	■	■	■
4000 SERIES TO 72"	STD	NA	NA	NA	NA	NA	NA	NA
4000 SERIES TO 96"	STD	NA	NA	NA	NA	NA	NA	NA
6000 AND 7000 CONTROLS AND KEYSWITCH**	NA	■	■	NA	NA	■	NA	■
6451 EXIT SENSOR BAR	STD	NA	■	NA	NA	■	NA	NA

NA = Finish not available. For best color match submit sample.

\* Excludes 6500, 6700, 6800 & 6900 Series. Special Finishes are not available on the 6600 Series.



## Door Handing

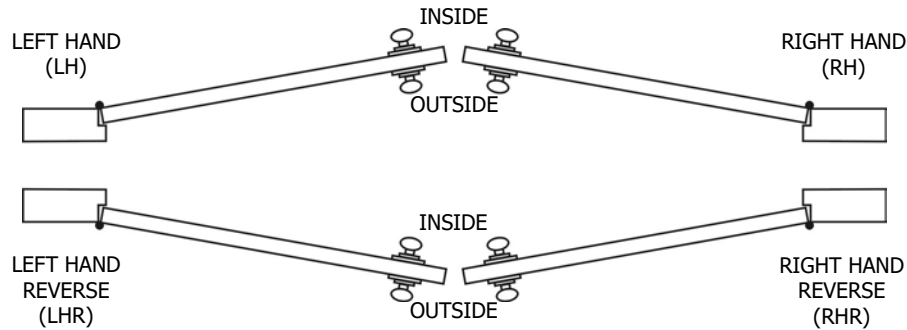

DOOR HAND DETERMINED FROM OUTSIDE

## Architectural Finish Reference

FINISH DESCRIPTION	U.S. STANDARD REFERENCE NO.	BHMA REFERENCE NO.
Satin Alum	US28	628
Bright Brass	US3	605
Satin Brass	US4	606
Light Bronze	US10	612
Medium Bronze	US13	617
Dark Bronze	US10B	613
Black Satin	US19	631
Bright Chrome	US26	625
Satin Stainless Steel	US32D	630



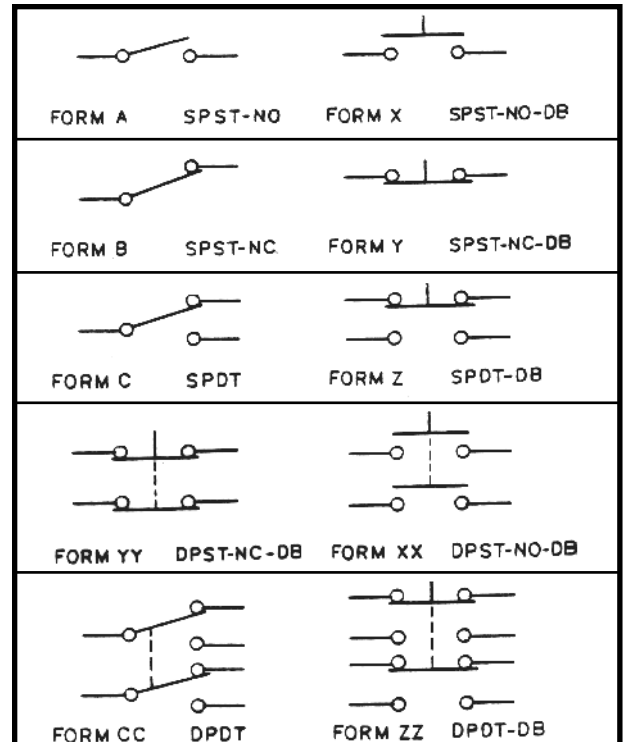



## Switch Contact Forms

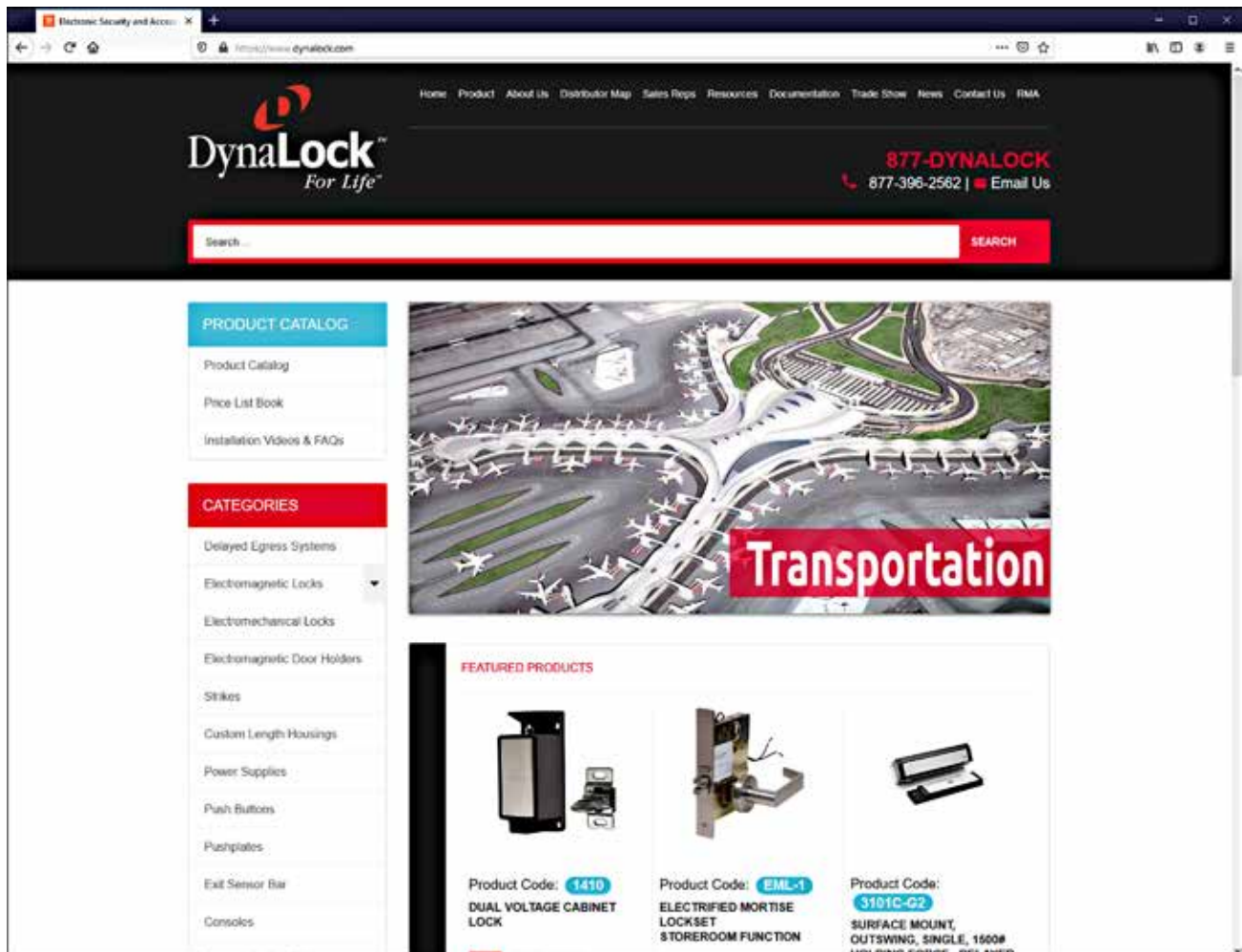

Need to know which distributors are in your region?  
In need of a maglock spec sheet to finish a quote?  
This downloadable content and more is at your fingertips!  
Please visit us on the web at:

[www.dynalock.com](http://www.dynalock.com)



-  Product Manuals & Templates
-  Sales & Technical Literature
-  Current List Price Book
-  New Product Announcements
-  Trade Show Schedule
-  Product Installation Videos

## Recently Discontinued Products

**1663 Series  
1/2" Surface  
Rim Strike**



**5025 Series  
Single Zone  
Power Supply**

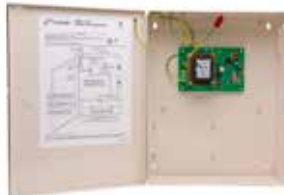

See Replacement 5725 Series  
Power Supply on Page 31.

**5400 Series  
Power Supply**



**5500 Series  
Multi Zone  
Power Supply**



See Replacement 5800 Series  
Power Supplies on Page 32.

**5600 Series  
Multi Zone  
Power Supply**



See Replacement 5900 Series  
Power Supplies on Page 33.

**6280 & 6282  
Series Vandal  
Resistant  
Push Buttons**



See Replacement 6285 Series  
Dual Mode Push Button on Page 37.



# PRODUCT CATALOG



## Lifetime Product Warranty

All DynaLock standard products are covered by our lifetime warranty. Any factory defective product will be repaired or replaced at no charge.

## Emergency Technical Support

Routine technical support is available Monday - Friday, 8:00 AM - 5:00 PM (EST)  
by calling the factory toll-free at **1-877-DYNALOCK (396-2562)**

**Emergency technical support** is available Monday - Friday, 5:00 PM - 8:00 PM (EST)  
by calling **(860) 637-2599, (860) 916-4805, or (860) 878-9085**

For Additional Information Contact:

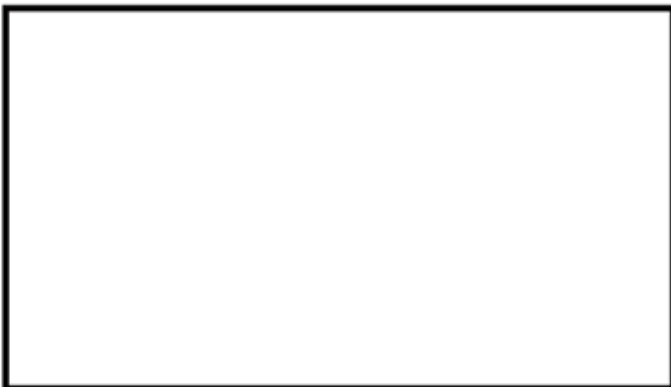

*Proudly Made  
In The USA*

### DynaLock Corporation

705 Emmett Street  
P.O. Box 2728  
Bristol, CT 06011-2728  
Ph/ 877-DYNALOCK (396-2562) Toll Free  
860-582-4761  
Fx/ 860-585-0338  
E-mail/ [info@dynalock.com](mailto:info@dynalock.com)  
Web/ [www.dynalock.com](http://www.dynalock.com)