

2Mp 30x Full HD HDCVI IR PTZ Dome Camera



Features

- 30x optical zoom
- Max. 25/30fps@1080P(1920 1080) & 50/60fps@720P resolution
- DWDR, Day/Night(ICR), Ultra DNR, Auto iris, Auto focus
- Control over coaxial cable, long distance real-time transmission
- HD and SD switchable
- Max 240°/s pan speed, 360° endless pan rotation
- Up to 300 presets, 5 auto scan, 8 tour, 5 pattern
- Built-in 2/1 alarm in/out
- Support intelligent 3D positioning with DH-SD protocol
- IR Distance up to 100m
- IP66, OSD

Technical Specifications



Model	PDC6CI230H	SD6C230I-HC
Camera		
Image Sensor	1/2.8" Exmor CMOS	
Effective Pixels	1920(H) x 1080(V), 2Megapixels	
Scanning System	Progressive	
Electronic Shutter Speed	1/1 ~ 1/30,000s	
Min. Illumination	Color: 0.05Lux@F1.4; B/W: 0.005Lux@F1.4; 0Lux (IR on)	Color: 0.05Lux@F1.6; B/W: 0.005Lux@F1.6; 0Lux (IR on)
S/N Ratio	More than 50dB	
Resolution	25/30fps@1080P, 25/30/50/60fps@720P	
Video Output	1-channel BNC HDCVI high definition video output/ CVBS standard definition video output (Can switch)	
Camera Features		
Day/Night	Auto(ICR) / Color / B/W	
Backlight Compensation	BLC / HLC / DWDR (Digital WDR)	
White Balance	Auto, ATW, Indoor, Outdoor, Manual	
Gain Control	Auto / Manual	
Noise Reduction	2D/3D	
Privacy Masking	Up to 24 areas	
Digital Zoom	16x	
Lens		
Focal Length	4.7mm~94mm (20x Optical zoom)	4.3mm~129mm (30x Optical zoom)
Max Aperture	F1.4 ~ F2.6	F1.6 ~ F5.0
Focus Control	Auto / Manual	
Angle of View	H: 54.1° ~ 3.2°	H: 65.1° ~ 2.34°
Close Focus Distance	100mm~ 1000mm	
PTZ		
Pan/Tilt Range	Pan: 0° ~ 360° endless; Tilt: -15° ~ 90°, auto flip 180°	
Manual Control Speed	Pan: 0.1° ~160° /s; Tilt: 0.1° ~120° /s	
Preset Speed	Pan: 240° /s; Tilt: 200° /s	
Preset	300	
PTZ Mode	5 Pattern, 8 Tour, Auto Pan, Auto Scan	
Speed Setup	Human-oriented focal length/ speed adaptation	
Power up Action	Auto restore to previous PTZ and lens status after power failure	
Idle Motion	Activate Preset/ Scan/ Tour/ Pattern if there is no command in the specified period	
Protocol	DH-SD, Pelco-P/D (Auto recognition)	
IR Distance	100m (2 near IR LED+ 4 far IR LED)	
Audio		

Interface	1 channel In
Auxiliary Interface	
RS485	1
Alarm	2/1 channel In/Out
General	
Power Supply	AC 24V/3A (±10%)
Power Consumption	10.5W, 26W (IR on, Heater on)
Working Environment	-40°C ~ 60°C / Less than 90% RH
Ingress Protection	IP66
Vandal Resistance	N/A
Dimensions	Φ204.7(mm) x 359.9(mm)
Weight	7.5kg

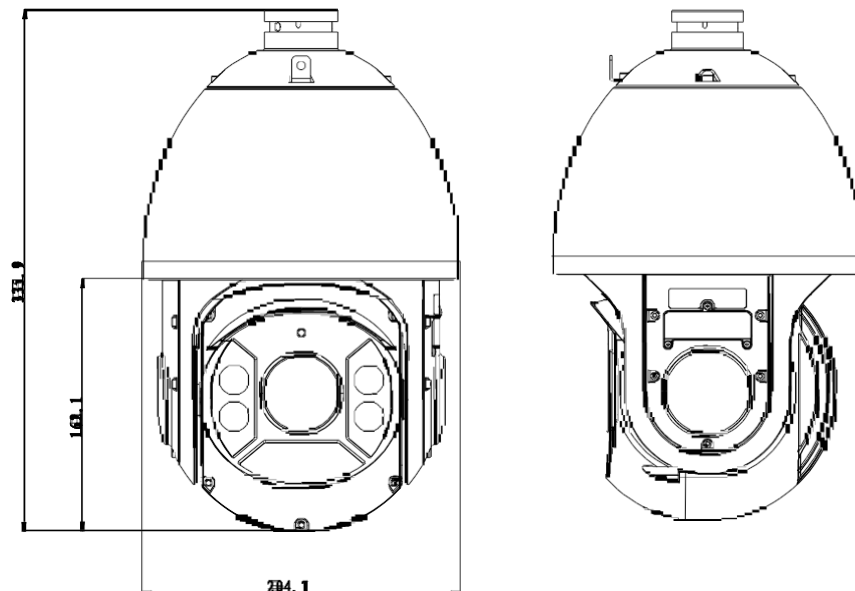





Dimensions (mm)



Accessories

	
DH-64FB	Power Supply

Accessories (Optional)

						
PFA111	PFB300C	PFA112	PFA113	PFA120	PFA150	PFA151