



# 2 MP Series Bullet Camera

## User Manual

### User Manual

Thank you for purchasing our product. If there are any questions, or requests, do not hesitate to contact the dealer.

This manual may contain several technical mistakes or printing errors, and the content is subject to change without notice. The updates will be added to the new version of this manual. We will readily improve or update the products or procedures described in the manual.

0300001091017

## Regulatory Information

### FCC Information

Please take attention that changes or modification not expressly approved by the party responsible for compliance could void the user's authority to operate the equipment.

**FCC compliance:** This equipment has been tested and found to comply with the limits for a Class A digital device, pursuant to part 15 of the FCC Rules. These limits are designed to provide reasonable protection against harmful interference when the equipment is operated in a commercial environment. This equipment generates, uses, and can radiate radio frequency energy and, if not installed and used in accordance with the instruction manual, may cause harmful interference to radio communications. Operation of this equipment in a residential area is likely to cause harmful interference in which case the user will be required to correct the interference at his own expense.

### FCC Conditions

This device complies with part 15 of the FCC Rules. Operation is subject to the following two conditions:

1. This device may not cause harmful interference.
2. This device must accept any interference received, including interference that may cause undesired operation.

### EU Conformity Statement



This product and - if applicable - the supplied accessories too are marked with "CE" and comply therefore with the applicable harmonized European standards listed under the Low Voltage Directive 2014/35/EU, the EMC Directive 2014/30/EU, the RoHS Directive 2011/65/EU.

 2012/19/EU (WEEE directive): Products marked with this symbol cannot be disposed of as unsorted municipal waste in the European Union. For proper recycling, return this product to your local supplier upon the purchase of equivalent new equipment, or dispose of it at designated collection points. For more information see: [www.recyclethis.info](http://www.recyclethis.info).

 2006/66/EC (battery directive): This product contains a battery that cannot be disposed of as unsorted municipal waste in the European Union. See the product documentation for specific battery information. The battery is marked with this symbol, which may include lettering to indicate cadmium (Cd), lead (Pb), or mercury (Hg). For proper recycling, return the battery to your supplier or to a designated collection point. For more information, see: [www.recyclethis.info](http://www.recyclethis.info).

### Industry Canada ICES-003 Compliance

This device meets the CAN ICES-3 (A)/NMB-3(A) standards requirements.

### Warning

This is a class A product. In a domestic environment this product may cause radio interference in which case the user may be required to take adequate measures.



## Safety Instruction

These instructions are intended to ensure that user can use the product correctly to avoid danger or property loss.

The precaution measure is divided into “Warnings” and “Cautions”.

**Warnings:** Serious injury or death may occur if any of the warnings are neglected.

**Cautions:** Injury or equipment damage may occur if any of the cautions are neglected.

	
<b>Warnings</b> Follow these safeguards to prevent serious injury or death.	<b>Cautions</b> Follow these precautions to prevent potential injury or material damage.



### Warnings

- In the use of the device, you must be in strict compliance with the electrical safety regulations of the nation and region.
- Input voltage should meet both the SELV (Safety Extra Low Voltage) and the Limited Power Source with 12 VDC according to the IEC60950-1 standard. Refer to technical specifications for detailed information.
- Do not connect multiple devices to one power adapter to avoid over-heating or a fire hazard caused by overload.
- Make sure that the plug is firmly connected to the power socket.
- Make sure that the device is firmly fixed if wall mounting or ceiling mounting is adopted.
- If smoke, odor or noise rise from the device, turn off the power at once and unplug the power cord, and then contact the service center.
- Never attempt to disassemble the camera by unprofessional personal.



### Cautions

- Do not drop the camera or subject it to physical shock.
- Do not touch sensor modules with fingers.
- Do not place the camera in extremely hot, cold (the operating temperature shall be -40°C to 60°C), dusty or damp locations, and do not expose it to high electromagnetic radiation.
- If cleaning is necessary, use clean cloth with a bit of ethanol and wipe it gently.
- Do not aim the camera at the sun or extra bright places.
- The sensor may be burned out by a laser beam, so when any laser equipment is in using, make sure that the surface of sensor will not be exposed to the laser beam.
- Do not expose the device to high electromagnetic radiation or extremely hot, cold, dusty or damp environment.
- To avoid heat accumulation, good ventilation is required for the operating environment.

- Keep the camera away from liquid while in use for non-water-proof device.
- While in delivery, the camera shall be packed in its original packing, or packing of the same texture.

## Mark Description

Table 0-1 Mark Description

Mark	Description
---	DC Voltage

# 1 Introduction

## 1.1 Product Features

The main features are as follows:

- High performance CMOS sensor
- Auto white balance
- Smart IR
- 3-Axis Adjustment

## 1.2 Overview

### 1.2.1 Overview of Type I Camera

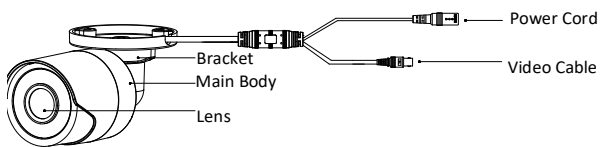

Figure 1-1 Overview of Type I Camera

#### Note:

This camera is TVI only.

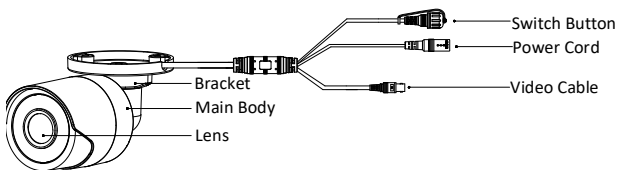

Figure 1-2 Overview of Type I Camera

#### Note:

Press and hold the switch button for 5 seconds to switch the video output. Four kinds of video outputs are available: TVI, AHD, CVI, and CVBS.

### 1.2.2 Overview of Type II Camera

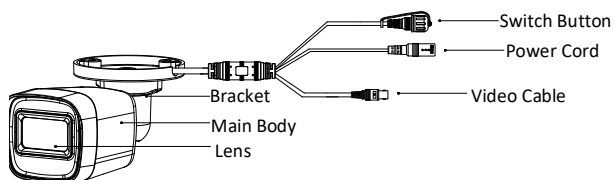

Figure 1-3 Overview of Type II Camera

#### Note:

Press and hold the switch button for 5 seconds to switch the video output. Four kinds of video outputs are available: TVI, AHD, CVI, and CVBS.

### 1.2.3 Overview of Type III Camera

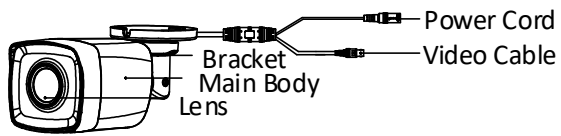

Figure 1-4 Overview of Type III Camera

**Note:**

This camera is TVI only.

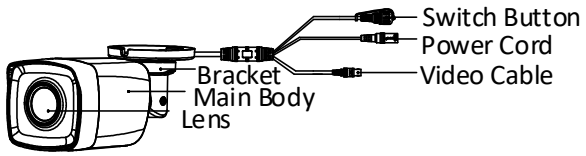

Figure 1-5 Overview of Type III Camera

**Note:**

Press and hold the switch button for 5 seconds to switch the video output. Four kinds of video outputs are available: TVI, AHD, CVI, and CVBS.

Commented [沈敏琰1]: 20191017 切换为非万向节支架

## 2 Installation

### Before you start

- Make sure that the device in the package is in good condition and all the assembly parts are included.
- Make sure that all the related equipment is power-off during the installation.
- Check the specification of the products for the installation environment.
- Check whether the power supply is matched with your power output to avoid the damage.
- Make sure the wall is strong enough to withstand three times the weight of the camera, and the mount.
- If the wall is cement, insert expansion bolts before installing the camera. If the wall is wooden, use self-tapping screws to secure the camera.
- If the product does not function properly, contact your dealer or the nearest service center. Do NOT disassemble the camera for repair or maintenance by yourself.

### 2.1 Installation of Type I/II Camera

#### 2.1.1 Ceiling/Wall Mounting without Junction Box

##### Before you start:

The ceiling mounting and the wall mounting of Type I and Type II camera are similar. Following takes ceiling mounting of Type I camera as an example.

##### Steps:

1. Drill the screw holes and the cable hole (optional) on the ceiling.

##### Note:

Drill the cable hole, when adopting the ceiling outlet to route the cable.

2. Route the cables through the cable hole, or the side opening.
3. Attach the bracket to the ceiling, and secure the camera with supplied screws. For cement ceiling, you need to mount the expansion bolts at first.

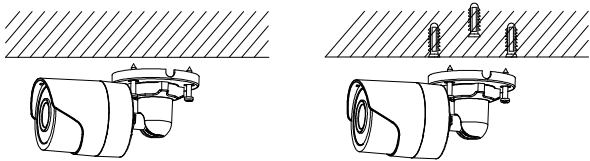

Figure 2-1 Secure the Camera on the Ceiling

4. Connect the corresponding power cord, and video cable.
5. Power on the camera to check whether the image on the monitor is gotten from the optimum angle. If not, loosen the bracket adjusting nut to adjust the position.

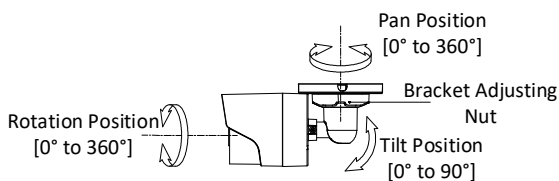

Figure 2-2 3-Axis Adjustment

#### 2.1.2 Ceiling/Wall Mounting with Junction Box

##### Before you start:

You need to purchase a junction box in advance. The installation of Type I and Type II camera are similar. Following takes Type I camera as an example.

**Steps:**

1. Paste the drill template on the ceiling/wall.
2. Drill screw holes and the cable hole on the ceiling according to the drill template.

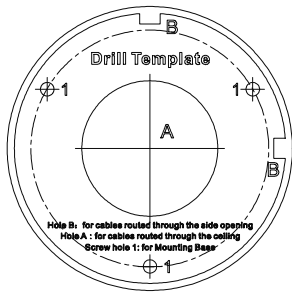

Figure 2-3 Drill Template of Junction Box

3. Take apart the junction box, and align the screw holes of the camera with those on the junction box's cover.
4. Attach the camera on the junction box's cover with supplied screws.

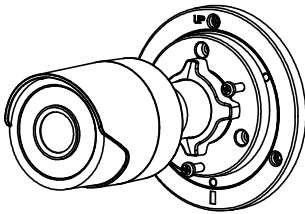

Figure 2-4 Attach the Camera on the Junction Box's Cover

5. Secure the junction box's body on the ceiling/wall with supplied screws.

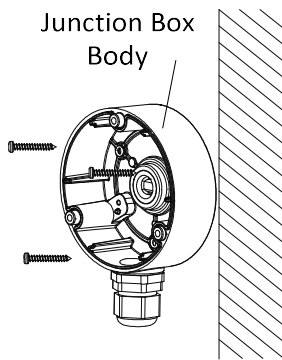

Figure 2-5 Secure the Junction Box on the Wall

6. Route the cables through the bottom cable hole, or the side cable hole of the junction box.
7. Combine the junction box cover with its body.

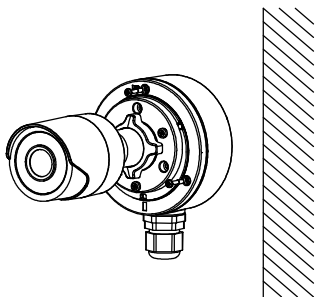

Figure 2-6 Combine the Junction Box Cover back to its Body

- Repeat the step 4 to 5 of 2.1.1 *Ceiling/Wall Mounting without Junction Box* to finish the installation.

## 2.2 Installation of Type III Camera

### 2.2.1 Ceiling/Wall Mounting without Junction Box

#### **Before you start:**

The installation of ceiling mounting and wall mounting are similar. Following takes ceiling mounting as an example.

#### **Steps:**

- Drill the screw holes and the cable hole (optional) on the ceiling.

#### **Note:**

Drill the cable hole, when adopting the ceiling outlet to route the cable.

- Route the cables through the cable hole, or the side opening.
- Attach the bracket to the ceiling, and secure the camera with supplied screws.

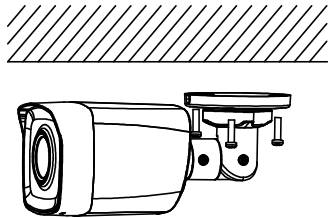

Figure 2-7 Secure the Camera on the Ceiling

#### **Note:**

- The supplied screw package contains self-tapping screws, and expansion bolts.
  - For cement wall/ceiling, expansion bolts are required to fix the camera. For wooden wall/ceiling, self-tapping screws are required.
- Connect the corresponding power cord, and video cable.
  - Power on the camera to check if the image on the monitor is gotten from the optimum angle. If not, adjust the camera according to the figure below.

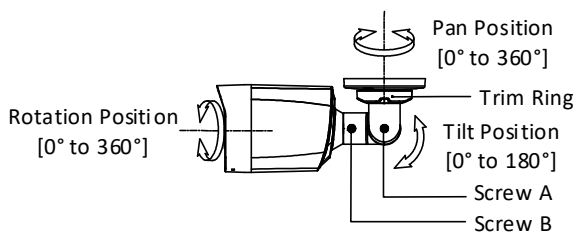

Figure 2-8 3-Axis Adjustment

- Loosen the trim ring to adjust the pan position [0° to 360°].
- Loosen screw A to adjust the tilt position [0° to 180°].
- Loosen screw B to adjust the rotation position [0° to 360°].

### 2.2.2 Ceiling/Wall Mounting with Junction Box

#### **Before you start:**

You need to purchase a junction box in advance.

- Paste the drill template on the ceiling/wall.
- Drill screw holes and the cable hole on the ceiling according to the drill template.



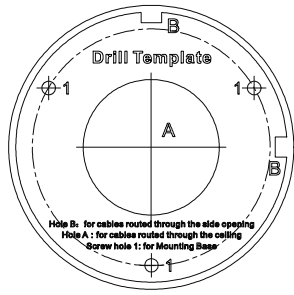

Figure 2-9 The Drill Template of the Junction Box

3. Take apart the junction box, and align the screw holes of the camera with those on the junction box's cover.
4. Attach the camera on the junction box's cover with supplied screws.

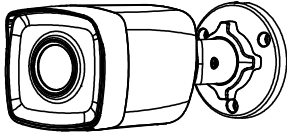

Figure 2-10 Attach the Camera on Junction Box's Body

5. Secure the junction box's body on the ceiling/wall with supplied screws.

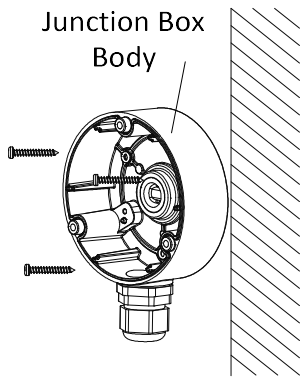

Figure 2-11 Secure the Junction Box on the Wall

6. Route the cables through the bottom cable hole, or the side cable hole of the junction box.
7. Combine the junction box cover with its body.

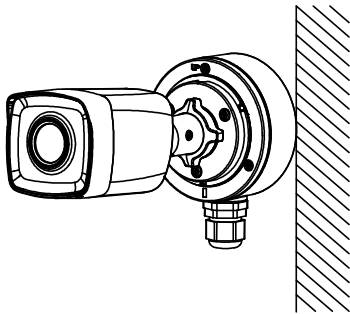

Figure 2-12 Combine the Junction Box Cover back to its

Body

8. Repeat step 4 to 5 of 2.2.1 *Ceiling/Wall Mounting without Junction Box* to finish the installation.

### 3 Menu Description

Please follow the steps below to call the menu.

**Note:**  
The actual display may vary with your camera model.

- Steps:**
1. Connect the camera with the TVI DVR, and the monitor, shown as the figure 3-1.

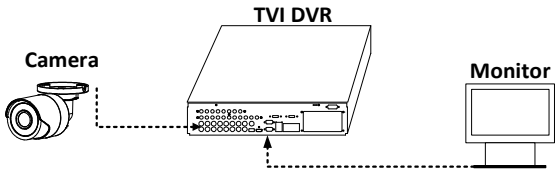

Figure 3-1 Connection

2. Power on the camera, TVI DVR, and the monitor to view the image on the monitor.
3. Click PTZ Control to enter the PTZ Control interface.
4. Call the camera menu by clicking button, or call the preset No. 95.

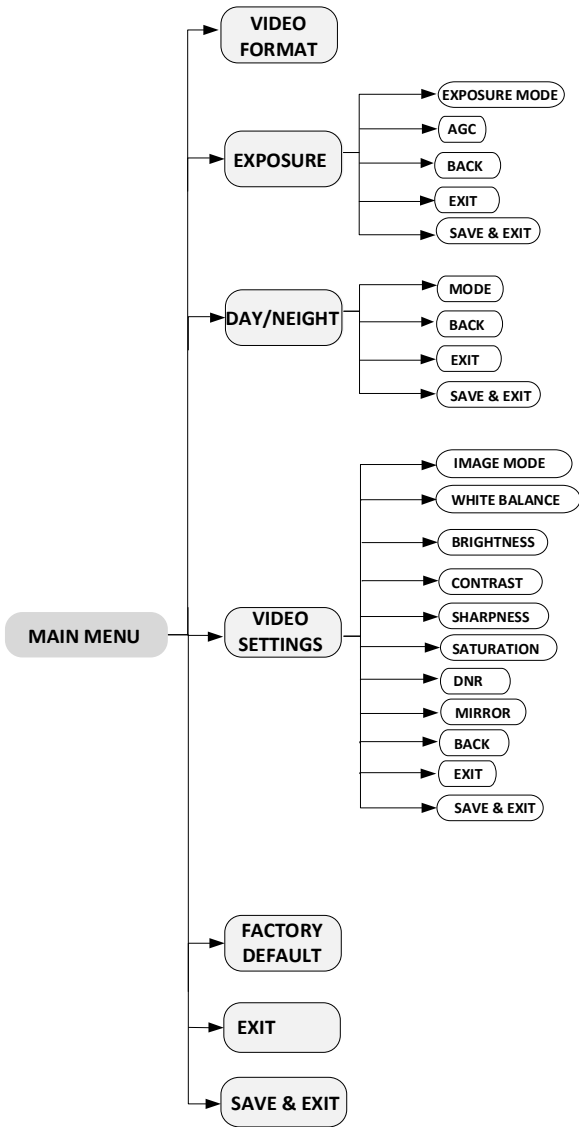

Figure 3-2 Main Menu Overview

5. Click the direction arrow to control the camera.
  - 1). Click up/down direction button to select the item.
  - 2). Click Iris + to confirm the selection.

- 3). Click left/right direction button to adjust the value of the selected item.

### 3.1 VIDEO FORMAT

You can set the video format to 2MP@30fps, 2MP@25fps, PAL or NTSC.

**Note:**

When switching the video output to TVI/ CVI/ AHD, you can set the video format to 2MP@30fps or 2MP@25fps; when switching the video output to CVBS, you can set the video format to PAL or NTSC.

### 3.2 EXPOSURE

#### EXPOSURE MODE

You can set the **EXPOSURE MODE** to **GLOBAL**, **BLC**, **HLC**, or **DWDR**.

- **GLOBAL**

GLOBAL refers to the normal exposure mode which adjusts lighting distribution, variations, and non-standard processing.

- **BLC (Backlight Compensation)**

BLC (Backlight Compensation) compensates light to the object in the front to make it clear, but this may cause the over-exposure of the background where the light is strong.

- **HLC (Highlight Compensation)**

HLC stands for highlight compensation. The camera detects the strong spots (the over-exposure portion of image), then reduce the brightness of the strong spots to improve the overall images.

- **DWDR (Digital Wide Dynamic Range)**

Digital wide dynamic range gives the camera the ability to view dark areas of the given image as well as extremely lighted portions of the image, or areas of high contrast.

#### **AGC (Auto Gain Control)**

It optimizes the clarity of the image in poor light conditions. The **AGC** level can be set to **HIGH**, **MEDIUM**, or **LOW**.

**Note:**

The noise will be amplified when setting the **AGC** level.

### 3.3 DAY/NIGHT

**COLOR**, **BW** (Black White), and **AUTO** are selectable for DAY/NIGHT switch.

#### **COLOR**

The image is colorful in day mode all the time.

#### **B&W (Black and White)**

The image is black and white all the time, and the **IR LIGHT** turns on in the poor light conditions.

You can turn on/off the **IR LIGHT** and set the value of **SMART IR** in this menu.

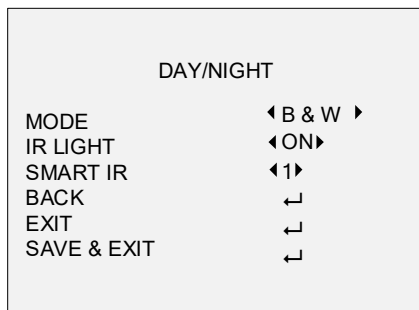

Figure 3-3 B&W

- **IR LIGHT**

You can turn on/off the **IR LIGHT** to meet different circumstances.

- **SMART IR**

The **Smart IR** function is used to adjust the light to its most suitable intensity, and prevent the image from over exposure. The **SMART IR** value can be adjusted from 0 to 3. The higher the value is, the more obvious effects are.

### **AUTO**

Automatically switch Color, or BW (Black and White) according to actual scene brightness.

You can turn on/off the **IR LIGHT**, and set the value of **SMART IR** in this menu.

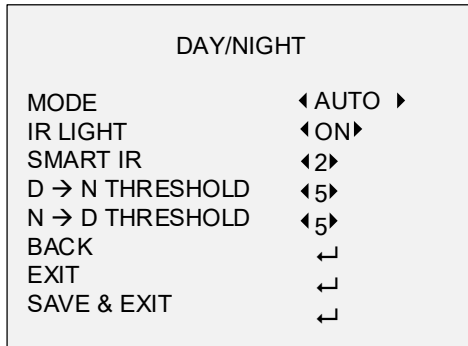

Figure 3-4 AUTO

- **IR LIGHT**

You can turn on/off the **IR LIGHT** to meet the requirements of different circumstances.

- **SMART IR**

The **Smart IR** function is used to adjust the light to its most suitable intensity, and prevent the image from over exposure. The **SMART IR** value can be adjusted from 0 to 3. The higher the value, the more obvious effects.

- **D→ N Threshold (Day to Night Threshold)**

**Day to Night Threshold** is used to control the sensitivity of switching the day mode to the night mode. You can set the value from 1 to 9. The larger the value is, the more sensitive the camera is.

- **N→ D Threshold (Night to Day Threshold)**

**Night to Day Threshold** is used to control the sensitivity of switching the night mode to the day mode. You can set the value from 1 to 9. The larger the value is, the more sensitive the camera is.

### **3.4 VIDEO SETTINGS**

Move the cursor to **VIDEO SETTINGS** and click Iris+ to enter the submenu. **IMAGE MODE, WHITE BALANCE, BRIGHTNESS, CONTRAST, SHARPNESS, SATURATION, DNR,** and **MIRROR** are adjustable.

VIDEO SETTINGS	
IMAGE MODE	◀ STD ▶
WHITE BALANCE	↵
BRIGHTNESS	◀ 5 ▶
CONTRAST	◀ 5 ▶
SHARPNESS	◀ 5 ▶
SATURATION	◀ 5 ▶
DNR	◀ 5 ▶
MIRROR	◀ OFF ▶
BACK	↵
EXIT	↵
SAVE & EXIT	↵

Figure 3-5 VIDEO SETTING

### IMAGE MODE

**IMAGE MODE** is used to adjust the image saturation, and you can set it to **STD** (Standard) or **HIGH-SAT** (High Saturation).

### WHITE BALANCE

White balance, the white rendition function of the camera, is to adjust the color temperature according to the environment. It can remove unrealistic color casts in the image. You can set **WHITE BALANCE** mode to **AUTO**, or **MANUAL**.

- **AUTO**

Under **AUTO** mode, white balance is being adjusted automatically according to the color temperature of the scene illumination.

- **MANUAL**

You can set the **R-GAIN/B-GAIN** value to adjust the shades of red/blue color of the image.

WHITE BALANCE	
MODE	◀ MANUAL ▶
R-GAIN	◀ 5 ▶
B-GAIN	◀ 5 ▶
BACK	↵
EXIT	↵
SAVE&EXIT	↵

Figure 3-6 MWB MODE

### BRIGHTNESS

Brightness refers to the brightness of the image. You can set the brightness value from 1 to 9 to darken or brighten the image. The greater the value is, the brighter the image is.

### CONTRAST

This feature enhances the difference in color and light between parts of an image.

### SHARPNESS

Sharpness determines the amount of detail an imaging system can reproduce.

### SATURATION

Saturation is the proportion of pure chromatic color in the total color sensation. Adjust this feature to change the saturation of the color.

### DNR

DNR reduces noise in video stream.

### MIRROR

**OFF**, **H**, **V**, and **HV** are selectable for mirror.

**OFF**: The mirror function is disabled.

**H**: The image flips 180° horizontally.

**V**: The image flips 180° vertically.

**HV:** The image flips 180° both horizontally and vertically.

### **3.5 FACTORY DEFAULT**

Reset all the settings to the factory default.

### **3.6 EXIT**

Move the cursor to **EXIT** and click Iris+ to exit the menu.

### **3.7 SAVE & EXIT**

Move the cursor to **SAVE & EXIT** and click Iris+ to save the settings, and exit the menu.