

# Quick Start Guide

## *GV-AS / EV Controller*



Thank you for purchasing GV-AS / EV Controller. This guide is designed to assist the new user in getting immediate results from the controllers. For advanced information on how to use the controllers, please refer to GV-AS / EV Controller User's Manual on the software CD / DVD.



© 2017 GeoVision, Inc. All rights reserved.

Under the copyright laws, this manual may not be copied, in whole or in part, without the written consent of GeoVision.

Every effort has been made to ensure that the information in this manual is accurate. GeoVision, Inc. makes no expressed or implied warranty of any kind and assumes no responsibility for errors or omissions. No liability is assumed for incidental or consequential damages arising from the use of the information or products contained herein. Features and specifications are subject to change without notice.

**Note:** No memory card slot or local storage function for Argentina.

GeoVision, Inc.  
9F, No. 246, Sec. 1, Neihu Rd.,  
Neihu District, Taipei, Taiwan  
Tel: +886-2-8797-8377  
Fax: +886-2-8797-8335  
<http://www.geovision.com.tw>

Trademarks used in this manual: *GeoVision*, the *GeoVision* logo and GV series products are trademarks of GeoVision, Inc. *Windows* is a registered trademark of Microsoft Corporation.

January 2017

# Contents

Contents.....	i
Important Note for Maintaining Power Supply.....	ii
GV-AS Controller Quick Start Guide.....	1
1. Basic Setup for GV-AS100 / 1010 / 110 / 1110 / 120.....	1
1.1 GV-AS100 / 1010.....	2
1.2 GV-AS110 / 1110.....	3
1.3 GV-AS120.....	4
2. Physical Wiring for GV-AS210 / 2110 / 2120 / 410 / 4110 / 810 / 8110 and GV-EV48	5
2.1 GV-AS210 / 2110 / 2120.....	5
2.2 GV-AS410 / 4110 / 810 / 8110.....	6
2.3 GV-EV48.....	7
3. Accessing the Web Interface of the GV-AS Controllers.....	8
4. Setting GV-AS Controller on GV-ASManager.....	9
5. Optional Devices for GV-AS100 / 110 / 120.....	10
5.1 Physical Wiring of GV-ASBox and GV-ASNet.....	11
5.2 Accessing the Web Interface of GV-AS100 / 110 / 120.....	12

## Important Note for Maintaining Power Supply

To make sure GV-AS / EV Controllers can function properly during a power outage, be sure to replace the internal battery on the controllers when needed. It is also recommended to install a backup battery for compatible GV-AS Controllers.

Refer to the following sections in *GV-AS Controller User Manual* for instructions on how to install a backup battery:

- **GV-AS100 / 110 / 120 through GV-ASBox:** See 9.1.4.F *Connecting Backup Battery*.
- **GV-AS100 / 110 / 120 through GV-ASNet:** See 9.2.4.F *Connecting Backup Battery*.
- **GV-AS210 / 2110 / 2120:** See 4.2.4 *Connecting Backup Battery*
- **GV-AS410 / 4110 / 810 / 8110:** See 5.2.4 *Connecting Backup Battery*
- **GV-EV48:** See 6.2.3 *Connecting Backup Battery*.

### Replaceable Button Cell (GV-AS100 / 2110 / 2120 / 4110 / 8110)

For GV-AS100 / 2110 / 2120 / 4110 / 8110, you can replace the battery on your own when you see low battery messages and icons in GV-ASManager.

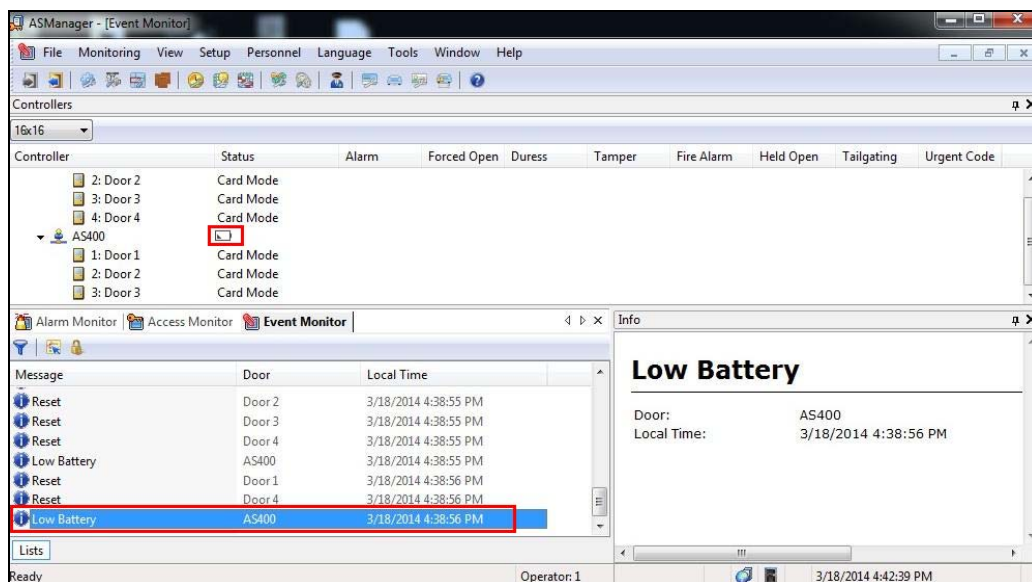

**Note:** Make sure the plastic insulation film under the battery is removed when using GV-AS100 / 2110 / 2120 / 4110 / 8110 for the first time. The low battery messages and icons will appear if the plastic film is not removed.

### Built-in Battery (GV-AS1010 / 110 / 1110 / 120 / 210 / 410 / 810 & GV-EV48)

When the controller runs out of battery, the local time on the controller will be reverted back to 1999/12/31. The controller time can be found on the Web interface of the controller on the Time Setting page and in the Access Monitor / Alarm Monitor / Event Monitor of GV-ASManager.

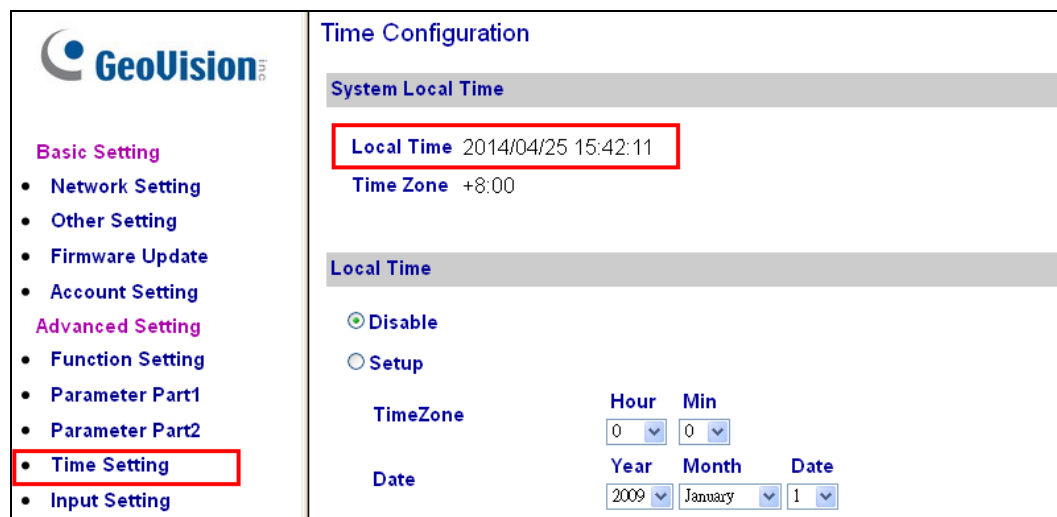

**Time Configuration**

**System Local Time**

**Local Time** 2014/04/25 15:42:11

**Time Zone** +8:00

**Local Time**

Disable

Setup

**TimeZone**

**Hour** 0 **Min** 0

**Date** **Year** 2009 **Month** January **Date** 1

When you see the controller year shown as 1999 or 2000, disconnect the controller from power and reconnect it to power. If the year is still shown as 1999 or 2000, the controller battery needs to be replaced. When this occurs, connect the controller to a backup battery and maintain connection with GV-ASManager at all times. When connected to GV-ASManager, the controller's time will be synchronized with GV-ASManager's time.

# GV-AS Controller Quick Start Guide

This guide lists the basic steps required to set up a GV-AS Controller. For detailed instructions, refer to the section number listed below each step.

## 1. Basic Setup for GV-AS100 / 1010 / 110 / 1110 / 120

This section covers the basic settings required to start running GV-AS100 / 1010 / 110 / 1110 / 120. For more settings on GV-AS100 / 110 / 120, refer to *5. Optional Devices for GV-AS100 / 110 / 120*. The section numbers listed here refers to the *GV-AS Controller User Manual*.

## 1.1 GV-AS100 / 1010

### Connect card readers (Optional)

Connect AS100 / 1010 to a reader.

*1.2.1 Connecting Card Readers*



### Connect input devices

Connect AS100 / 1010 to input devices (Ex: a push button to exit).

*1.2.2 Connecting Input Devices*



### Connect output devices

Connect AS100 / 1010 to output devices (Ex: a door lock).

*1.2.3 Connecting Output Devices*



### Connect to PC

Connect the controller to a computer through RS485 connection (AS100) or network connection (AS100 & AS1010).

*1.2.4 Connecting the PC*



### Connect to Power

Connect AS100 / 1010 to power using the supplied adaptor.

*1.2.5 Connecting the Power*



### Programming the GV-AS100 / 1010

Create a Master Card (AS100) or Enroll / Delete Card (AS1010) to add and delete cards. For other settings, use the built-in keypad to type the commands.

*1.3 Programming Mode*



**GV-AS100**



**GV-AS1010**

## 1.2 GV-AS110 / 1110

### Connect card readers (Optional)

Connect AS110 / 1110 to a reader..

*2.2.1 Connecting Card Readers*



### Connect input devices

Connect AS110 / 1110 to input devices (Ex: a push button to exit).

*2.2.2 Connecting Input Devices*



### Connect output devices

Connect AS110 / 1110 to output devices (Ex: a door lock).

*2.2.3 Connecting Output Devices*



### Connect to PC

Connect the controller to a computer through RS485 connection (AS110) or network connection (AS110 & AS1110).

*2.2.4 Connecting the PC*



### Connect to Power

Connect AS110 / 1110 to power using the supplied adaptor.

*2.2.5 Connecting the Power*



### Programming the GV-AS110 / 1110

Create an Enroll Card and a Delete Card to add and delete cards. For other settings, use the built-in keypad to type the commands.

*2.3 Programming Mode*



**GV-AS110 / 1110**



## 1.3 GV-AS120

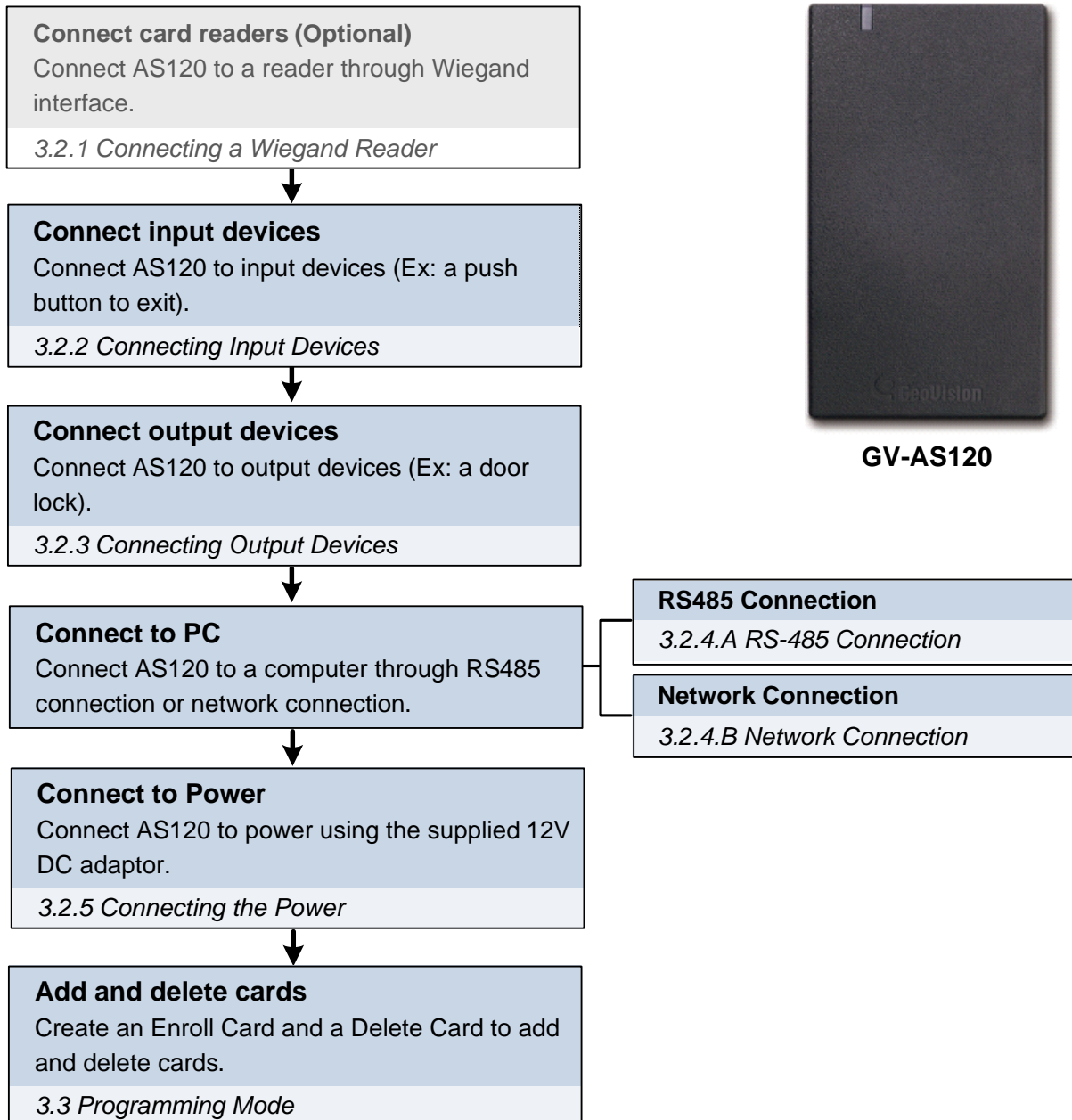

## 2. Physical Wiring for GV-AS210 / 2110 / 2120 / 410 / 4110 / 810 / 8110 and GV-EV48

### 2.1 GV-AS210 / 2110 / 2120

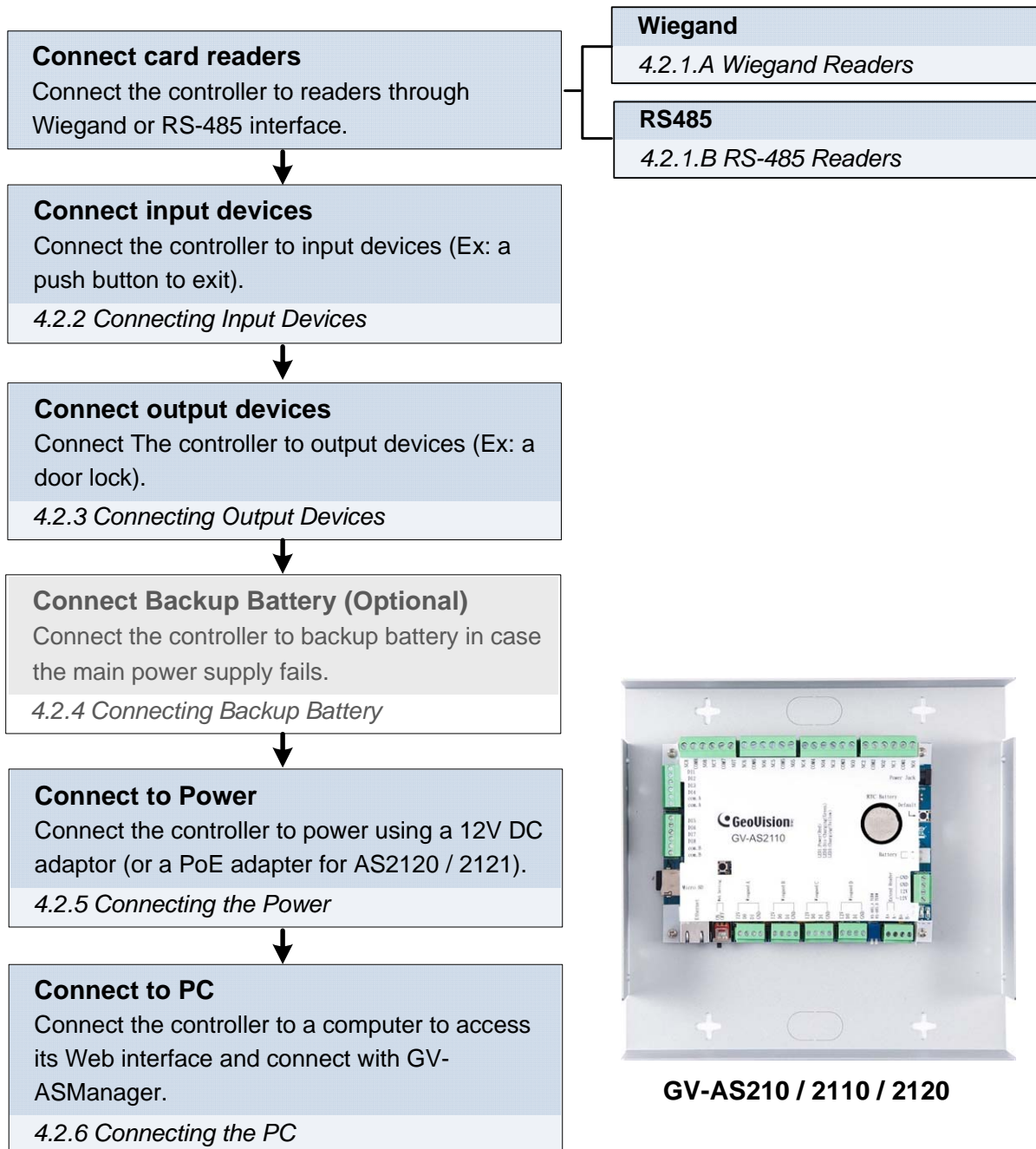

## 2.2 GV-AS410 / 4110 / 810 / 8110

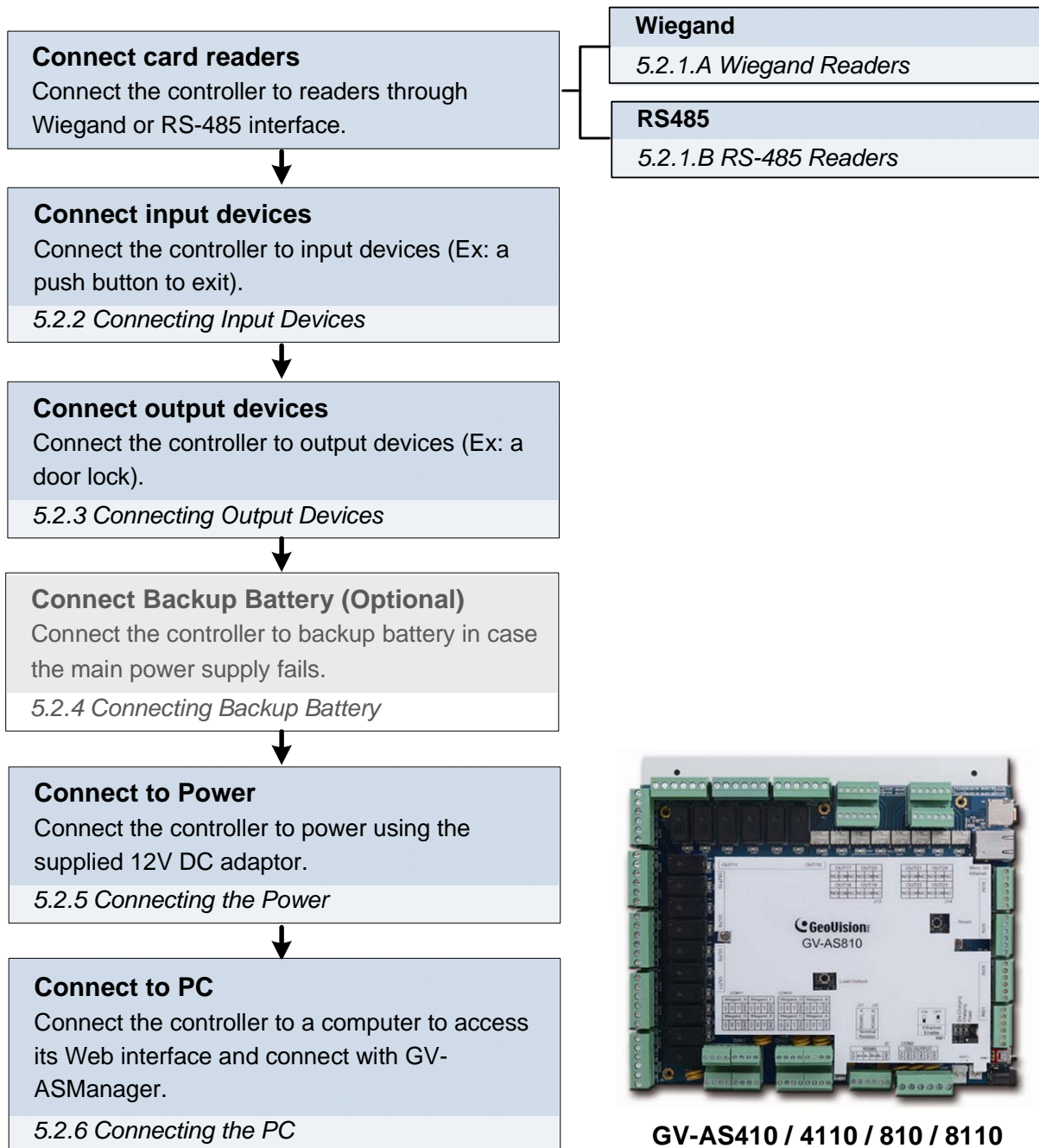

**GV-AS410 / 4110 / 810 / 8110**

## 2.3 GV-EV48

### **Connect card readers**

Connect EV48 to readers through RS-485 interface.

*6.2.1 Connecting RS-485 Card Readers*



### **Connect output relay**

Connect EV48 output relays to the corresponding floor on the elevator control panel.

*6.2.2 Connecting Output Relay*



### **Connect Backup Battery (Optional)**

Connect EV48 to backup battery in case the main power supply fails.

*6.2.3 Connecting Backup Battery*



### **Connect to Power**

Connect EV48 to power using the supplied 12V DC adaptor.

*6.2.4 Connecting the Power*



### **Connect to PC**

Connect EV48 to a computer to access its Web interface and connect with GV-ASManager.

*6.2.5 Connecting the PC*

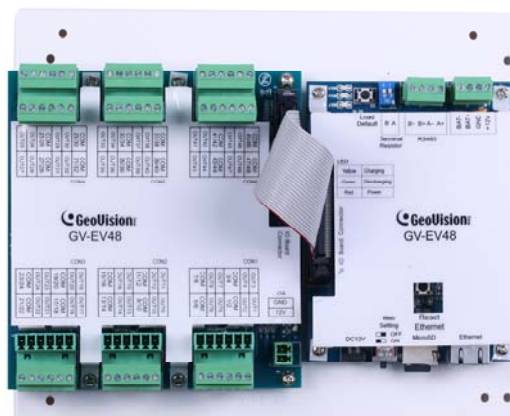

**GV-EV48**

### 3. Accessing the Web Interface of the GV-AS Controllers

After connecting the required wires and cables for the following GV-AS Controllers, access the Web interface of the GV-AS Controller to define the devices connected: GV-AS1010 / 1110 / 210 / 2110 / 2120 / 410 / 4110 / 810 / 8110 and GV-EV48. The section numbers listed here refers to the *GV-AS Controller User Manual*.

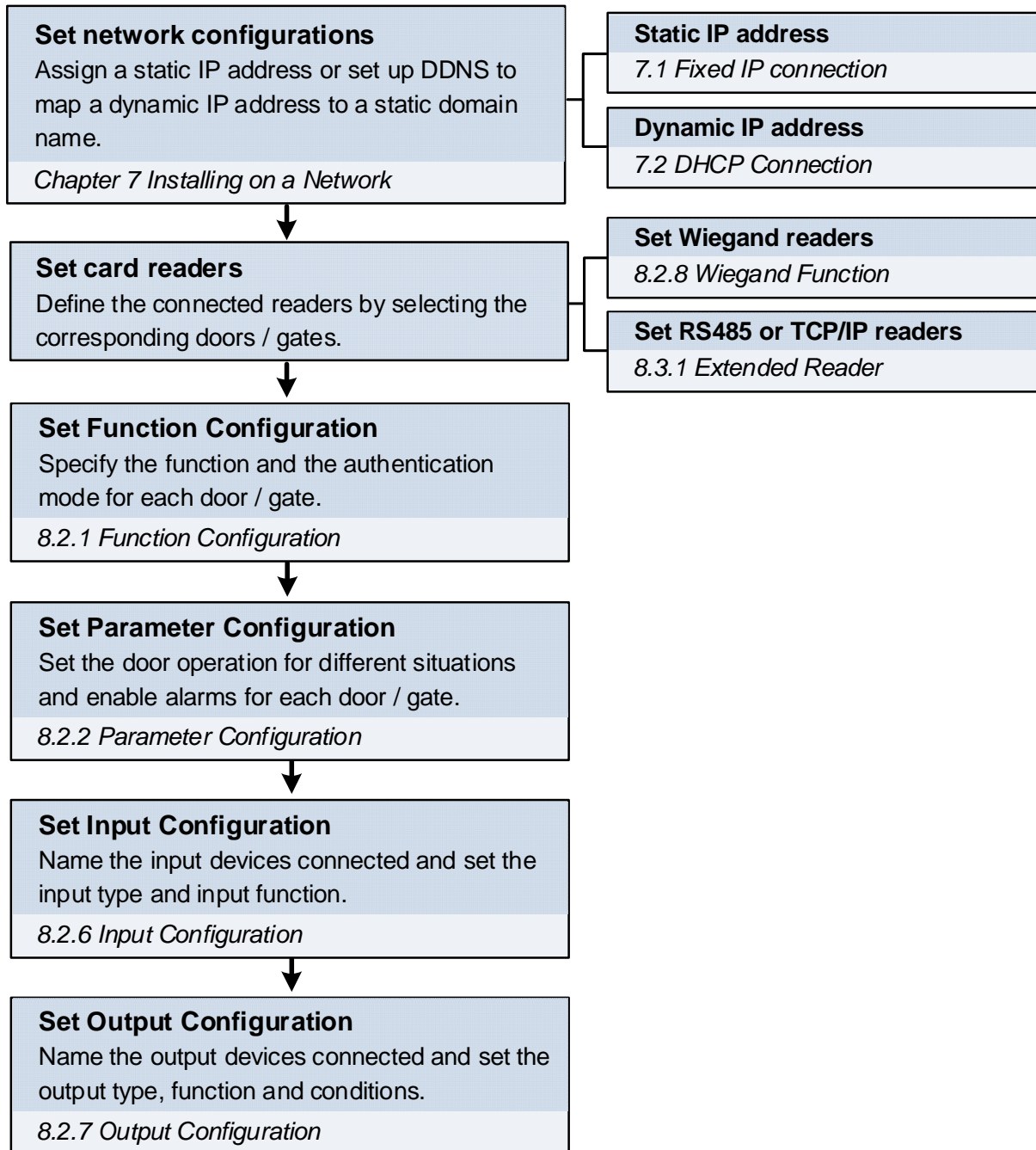

**Note:** The Wiegand Function and Output Settings pages are not available for GV-AS1010 / 1110 and GV-EV48. For GV-EV48, the Input Setting page is also not available.



## 4. Setting GV-AS Controller on GV-ASManager

After setting up the Web interface, connect the GV-AS Controller to a GV-ASManager.

Through GV-ASManager, you can set up the doors and enroll cards. The section numbers listed here refers to the *GV-ASManager User Manual*.

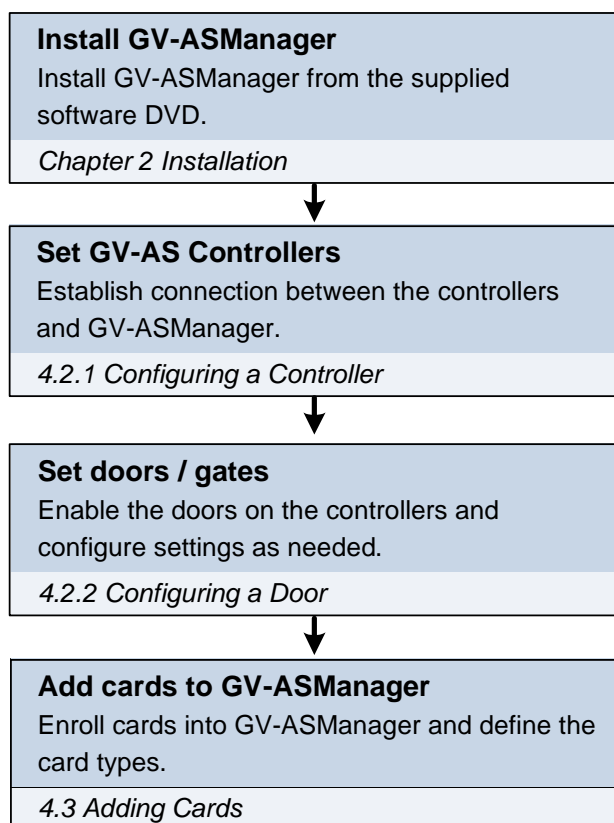

## 5. Optional Devices for GV-AS100 / 110 / 120

To access GV-AS100 / 110 / 120 on a network, an optional device GV-ASBox or GV-ASNet is required. GV-ASBox also supports connection with additional input devices, output devices and readers through Wiegand interface and RS-485 interface. GV-ASNet supports additional readers through RS-485 connection.

You will need to first complete the physical wiring of GV-ASBox or GV-ASNet before accessing the Web interface. After the controller is installed on a network, GV-AS100 / 110 / 120 can also connect with GV-ASManager for advanced settings. Refer to *4. Setting GV-AS Controller on GV-ASManager* for details.

## 5.1 Physical Wiring of GV-ASBox and GV-ASNet

The section numbers listed here refers to the *GV-AS Controller User Manual*.

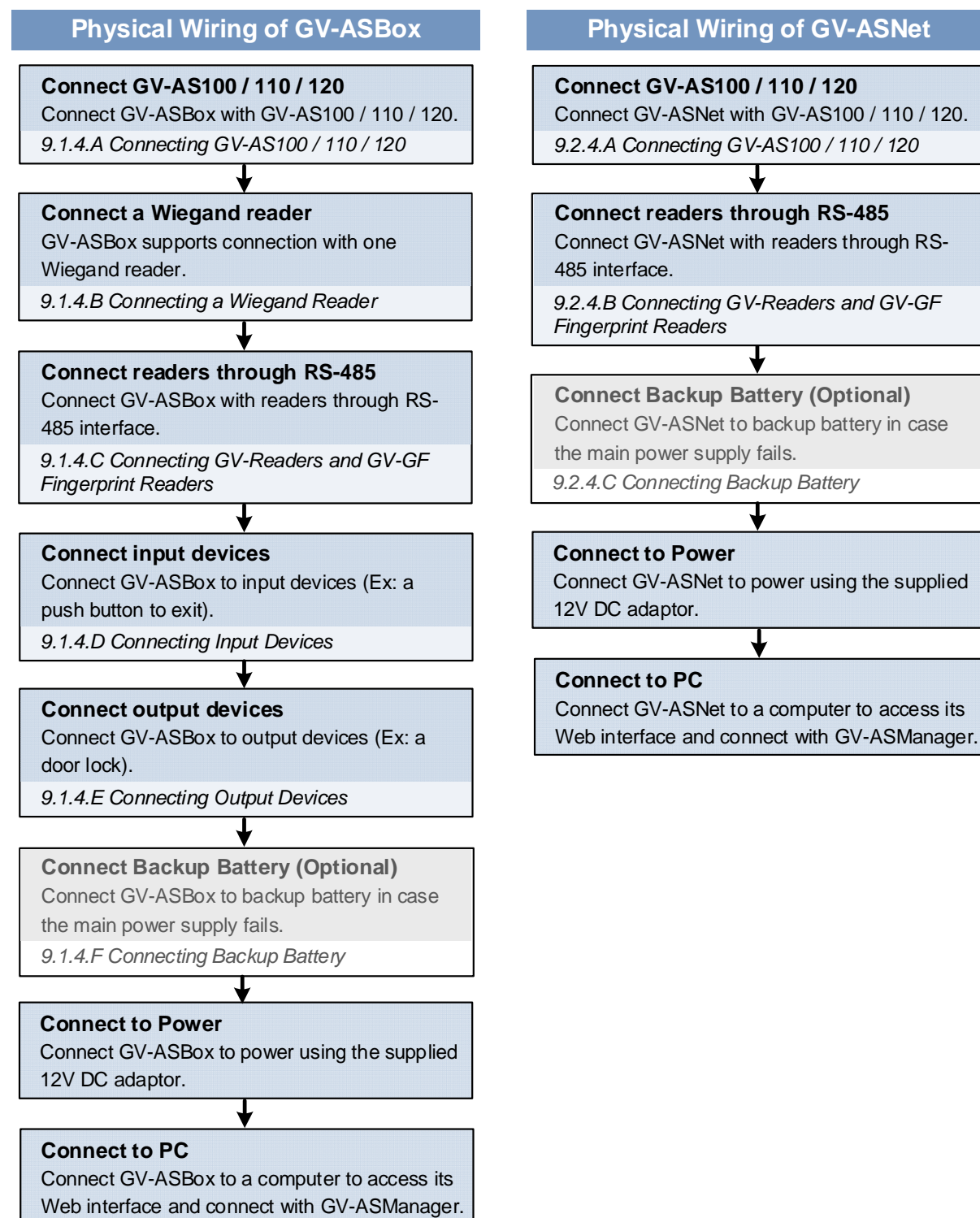



## 5.2 Accessing the Web Interface of GV-AS100 / 110 / 120

The section numbers listed here refers to the *GV-AS Controller User Manual*.

