

GV-FER12700 12MP H.265 Low Lux WDR IR Fisheye Rugged IP Camera



Introduction

GV-FER12700 is a 12 MP outdoor fisheye camera allowing you to monitor all angles of a location and can be installed to the ceiling and the wall. GV-FER12700 supports H.265 video codec to achieve better compression ratio while maintaining high video quality at reduced network bandwidths. Equipped with automatic IR-cut filter and IR LEDs, GV-FER12700 is capable of day and night surveillance. Without installing any software, you can watch live view and utilize functions such as video recording, privacy mask and alert notification through the Web interface. In addition, the camera seamlessly integrates with the GV-DVR / NVR / VMS, providing advanced monitoring and video management features.

Key Features

- 1/1.7" progressive scan CMOS
- Triple streams from H.265, H.264 and MJPEG
- Up to 30 fps at 4000 x 3000
- Day and night (with removable IR-cut filter)
- Wide Dynamic Range (WDR)
- Intelligent IR
- Vandal resistance (IK10+ for metal casing)
- Ingress protection (IP67)
- 12V DC / PoE+ (IEEE 802.3at)
- Built-in micro SD card slot (SD/SDHC/SDXC/UHS-I) for local storage
- USB slot for WiFi adapter or USB hard drive
- One sensor input and alarm output
- Built-in microphone
- [Digital Object Tracking](#)
- Provides 360° and 180° panorama view
- Stereographic projection to reduce the distortion of the image
- Different angle of view accessible by multiple users at the same time
- Playback from any view angle and zoom level
- No mechanical moving parts
- Two-way audio
- Low lux enhancement
- 3D noise reduction
- Smart streaming
- Tampering alarm
- Virtual PTZ function
- Auto Pan function
- Privacy mask
- Visual automation
- Text overlay
- 31 languages on Web interface
- ONVIF (Profile S) conformant
- Recording assigned by GV-Edge Recording Manager ([Windows version](#))
- TAICS IoT Cyber Security certified

* No Memory Card Slot & local storage function for Argentina.

* Smart streaming requires GV-DVR / NVR V8.7.0, GV-VMS V16.10.3.0 or later software versions.

The following is a comparison of live view between a third-party fisheye camera and a GV-Fisheye Camera with IR LED.

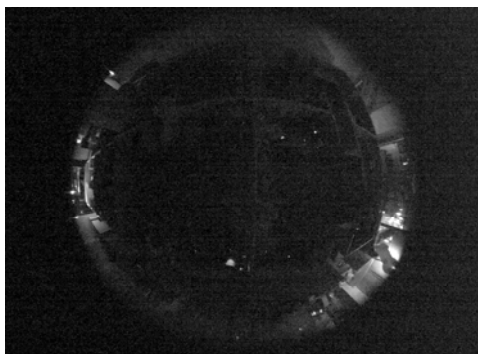

Third-Party Fisheye Camera

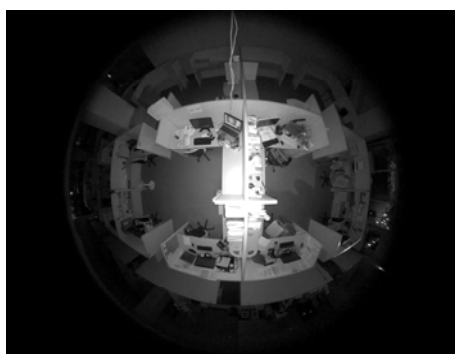

GV-Fisheye Camera with IR LED

Photos

Fisheye Source Image

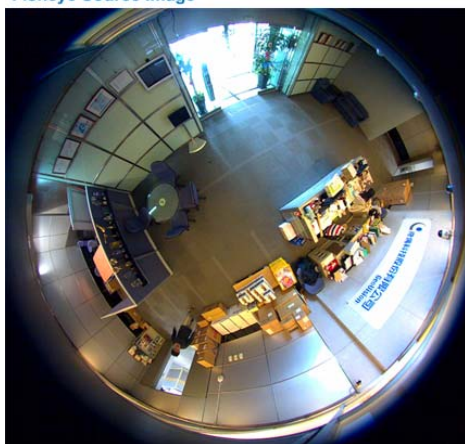

Single View



2 x 180° View



360° View



Quad View

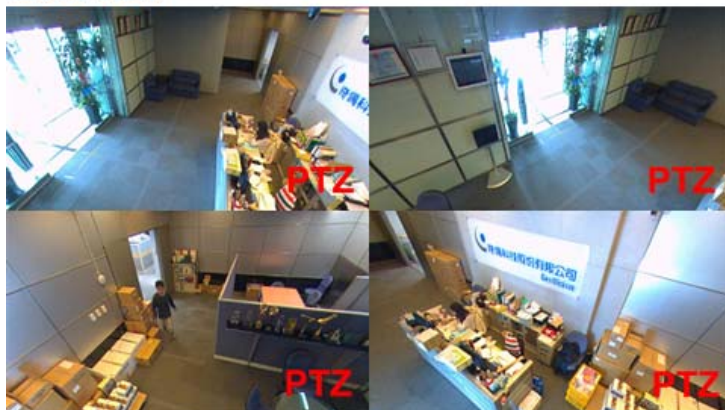

Dimensions

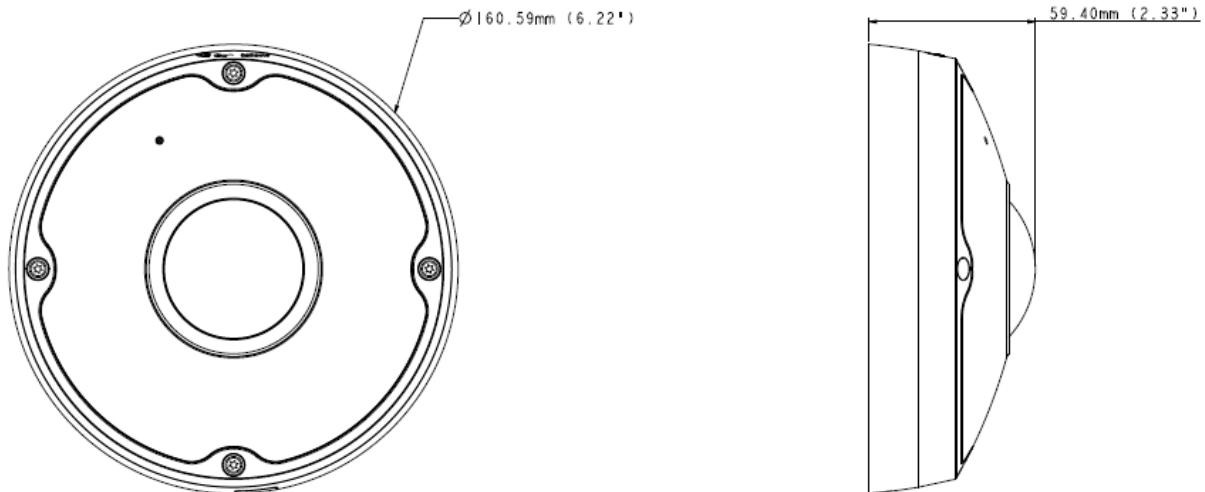

Specifications

System Requirements		
CPU	Intel Core i5-4670, 3.40 GHz	
Memory	DDR3 8 GB RAM	
On Board Graphics	Intel HD Graphics 4600 (Version of driver from year 2014 or later required)	
Camera		
Image Sensor	1/1.7" progressive scan CMOS	
Picture Elements	4000 (H) x 3000 (V)	
Minimum Illumination	Color	0.1 Lux
	B/W	0.05 Lux
	IR On	0 Lux
Shutter Speed	Automatic, Manual (1/5 ~ 1/16000 sec)	
White Balance	Automatic, Manual (2800K ~ 8500K)	
Gain Control	Automatic	
S/N Ratio	52 dB	
WDR	Yes	
Dynamic Range	Up to 72 dB	
Optics Lens		
Megapixel	Yes	
Day/Night	Yes (with removable IR-cut filter)	
Lens Type	Fixed	
Focal Length	1.2 mm	
Maximum Aperture	F/2.2	
Mount	M12	
Image Format	1/1.7"	
Horizontal FOV	180°	
Operation	Focus	Fixed
	Zoom	Fixed
	Iris	Fixed
IR LED Quantity	6 IR LEDs	
Max. IR Distance	30 m (100 ft)	
Operation		
Video Compression	H.265, H.264, MJPEG	
Video Streaming	Stream 1 from H.265 or H.264	
	Stream 2 from H.265, H.264 or MJPEG	
	Stream 3 from H.265, H.264 or MJPEG	

Frame Rate	25/30 fps at 4000 x 3000 or 3160 x 3000 (50/60 Hz) *The frame rate and the performance may vary depending on the number of connections and data bitrates (different scenes).	
Image Setting	Brightness, Contrast, Saturation, Sharpness, Gamma, White Balance, Flicker-less, Image Orientation (Flip, Mirror, 0°, 180°), Shutter Speed, D/N Sensitivity, Backlight Compensation, WDR, Defog, Low Lux Enhancement, Denoise, Metering	
Audio Compression	G.711	
Audio Support	Two-way Audio (external speaker required)	
Sensor Input	1 input (Dry Contact)	
Sensor Output	1 digital output (200mA 5V DC)	
Video Resolution		
Main Stream	4:3	4000 x 3000 (Default)
	20:19	3160 x 3000
Sub Stream	4:3	1024 x 768 (Default), 640 x 480
	20:19	960 x 912, 640 x 608
Third Stream (Closed by Default)	4:3	640 x 480
	20:19	640 x 608
Network		
Interface	10/100/1000 Ethernet	
Protocol	DHCP, DNS, DynDNS, FTP, HTTP, HTTPS, ICMP, IPv4, IPv6, Multicast, NTP, ONVIF (Profile S), QoS (DSCP), RTCP, RTSP, SNMP, SMTP, SSL, TCP/IP, UDP, UPnP, 3GPP/ISMA	
Wireless LAN	IEEE 802.11 b/g/n	
Antenna Type	External	
Security	WEP, WPA-PSK(TKIP), WPA-PSK(AES), WPA2-PSK(TKIP), WPA2-PSK(AES)	
Security Feature	<ul style="list-style-type: none"> - No default ID and Password - 802.1x authentication - HTTPS with a SSL certificate stored in the camera - 256-bit AES encryption (requires working with GV-VMS V18.1 or later) 	
Mechanical		
Temperature Detector	Yes	
Connectors	Power	2-pin terminal block (DC 12V, 3.5A), PoE
	Ethernet	RJ-45
	Audio	1 In (Built-in or external microphone) 1 Out (Stereo phone jack, 3.5 mm / 0.14")
	Digital I/O	3-pin terminal block
	Auto Iris	None
	Local Storage	Micro SD card slot (SD/SDHC/SDXC/UHS-I, Class 10) *UHS-II card type is not supported.
	USB	GV-WiFi Adapter or USB hard drive
General		
Operating Temperature	Start-up	-20°C ~ 50°C (-4°F ~ 122°F)
	Operation	-30°C ~ 50°C (-22°F ~ 122°F)
Humidity	10% to 90% (no condensation)	
Power Source	12V DC / PoE+ (IEEE 802.3at)	
Max. Power Consumption	17 W	
Dimension	Ø 160.59 x 59.40 mm m (Ø 6.22" x 2.33")	
Weight	700 g (1.54 lb)	
Ingress Protection	IP67	
Vandal Resistance	IK10+ for metal casing	
Regulatory	CE, FCC, LVD, RoHS, TAICS (IoT Cyber Security) compliant	
Power over Ethernet		
PoE Standard	PoE+ (IEEE 802.3at Class 4 Power over Ethernet / PD)	
PoE Power Supply Type	End-Span and Mid-Span	
PoE Power Output	Per Port 48V DC, 600mA. Max. 30 watts	

Web Interface	
Installation Management	Web-based configuration
Maintenance	Firmware upgrade through Web Browser or Utility
Access from Web Browser	Camera Live View, Video Recording, Change Video Quality, Bandwidth Control, Image Snapshot, Audio, Picture in Picture, Picture and Picture, Privacy Mask, Text Overlay, Digital PTZ
Language	Arabic / Bulgarian / Czech / Danish / Dutch / English / Finnish / French / German / Greek / Hebrew / Hungarian / Indonesian / Italian / Japanese / Lithuanian / Norwegian / Persian / Polish / Portuguese / Romanian / Russian / Serbian / Simplified Chinese / Slovakian / Slovenian / Spanish / Swedish / Thai / Traditional Chinese / Turkish
Applications	
Software Supported	GV-DVR / NVR (V8.8.0), GV-VMS (V17.3.0), GV-Control Center (V3.6.0), GV-Edge Recording Manager Windows Version (V1.4.0), GV-Recording Server / Video Gateway (V1.4.2), GV-Redundant / Failover Server (V1.1.0.0), GV-Mobile Server (V1.5.0.0)
Smart Device Access	GV-Eye for iOS and Android
Live Viewing	Browser (IE, Chrome, Firefox, Safari), Mobile App
CMS Server support	GV-Control Center, GV-Center V2, GV-Vital Sign Monitor

Note:

- It is required to apply patch files to some of the supported software.
- Do not use clothes or any ordinary material to clean the camera cover since they may result in scratches.
- Mind the following when using an inserted memory card for recording:
 - Recorded data on the memory card can be damaged or lost if the data are accessed while the camera is under physical shock, power interruption, memory card detachment or when the memory card reaches the end of its lifespan. No guarantee is provided for such causes.
 - The stored data can be lost if the memory card is not accessed for a long period of time. Back up your data periodically if you seldom access the memory card.
 - Memory cards are expendable and their durability varies according to the conditions of the installed site and how they are used. Back up your data regularly and replace the memory card annually.
 - To avoid power outage, it is highly suggested to apply a battery backup (UPS).
 - For better performance, it is highly suggested to use Micro SD card of MLC NAND flash, Class 10.
 - Replace the memory card when its read/write speed is lower than 6 MB/s or when the memory card is frequently undetected by the camera.
- Specifications are subject to change without notice.





Packing List

- | | |
|-----------------------------|-------------------------|
| 1. H.265 Fisheye Camera | 8. Terminal Block |
| 2. Back Plate | 9. Installation Sticker |
| 3. Plate Screw x 3 | 10. Ruler |
| 4. Plastic Screw Anchor x 3 | 11. Silica Gel Bag x 2 |
| 5. Torx Wrench | 12. Download Guide |
| 6. RJ-45 Connector | 13. Warranty Card |
| 7. Data Cable | |

Accessories

Model No.	Name		Details
GV-Mount100	Straight Tube and Junction Box Kit		Dimensions: 200 x 170 x 257.5 mm (7.9" x 6.7" x 10.1") Weight: 3.17 kg (6.99 lb)

Model No.	Name		Details
GV-Mount101	Straight Tube Kit		Dimensions: 219 x 125 x 332 mm (8.6" x 4.9" x 13.1") Weight: 1.8 kg (3.97 lb)
GV-Mount200	Wall Pendant Mount		Dimensions: 225 x 140 x 250 mm (8.9" x 5.5" x 9.8") Weight: 900 g (1.98 lb) Note: To ensure the image quality, leave a distance of 1 M or more between the camera body and the wall.
GV-Mount203	Wall Mount and Junction Box		Dimensions: 315 x 195.5 x 225 mm (12.4 x 7.7 x 8.9") Weight: 2.95 kg (6.5 lb)
GV-Mount206	Wall Box Mount		Dimensions: \varnothing 176.85 x 126.5 x 211.3 mm (\varnothing 6.96" x 5" x 8.3") Weight: 0.93 kg / 2.06 lb Note: To ensure the image quality, leave a distance of 1 M or more between the camera body and the wall.
GV-Mount 208-2	Swan Neck Mount		Dimensions: 1043 x 519 x 256 mm (41.06" x 20.43" x 10.08") Weight 10.5 kg (23.15 lb)
GV-Mount702	Extension Tube		Four options are available. Dimensions: \varnothing 5.4 x 10 or 20 or 30 or 50 cm (\varnothing 2.1" x 3.9" or 7.9" or 11.8" or 19.7") Weight: 180 g or 390 g or 550 g or 800 g (0.4 lb or 0.86 lb or 1.21 lb or 1.76 lb)

Model No.	Name	Details
GV-Mount903-1	Dome Housing	 <p>Dimensions: Ø 185.51 x 165.35 mm (Ø 7.3" x 6.51") Weight: 900 g (1.98 lb)</p>
GV-Mount904-1	Tilting Wall Mount Bracket	 <p>Dimensions: Ø 159.1 x 40.5 mm (Ø 6.3" x 1.6") Weight: 350 g (0.77 lb)</p>
GV-Mount912	Power Box Mount Bracket	 <p>Dimensions: Ø 146 x 10.5 mm (Ø 5.7" x 0.4") Weight: 180 g (0.4 lb)</p>
GV-WiFi Adaptor V2		 <p>Dimensions: 15 x 15 x 155 mm (0.59" x 0.59" x 6.10") Weight: 0.01 kg (0.02 lb)</p>
GV-Relay V2		GV-Relay V2 is designed to expand the voltage load of GV IP devices. It provides 4 relay outputs, and each can be set as normally open (NO) or normally closed (NC) independently as per your requirement.
GV-POE Switch		GV-POE Switch is designed to provide power along with network connection for IP devices. GV-POE Switch is available in various models with different numbers and types of ports.
Power Adaptor		Contact our sales representatives for the countries and areas supported.

Compatible SD Cards for GV-FER12700

Below is a list of SD cards tested and certified by GeoVision to be compatible with GV-FER12700.

MLC NAND flash SD Cards	
Brand	Model
ADATA	IDU3A UHS-I 32GB MLC MicroSD Card (IDU3A-032GM)
Innodisk	3ME2 UHS-I 32GB MLC MicroSD Card
SanDisk	Industrial MLC UHS-I 64GB MicroSD Card (SDSDQAF3-064G)
Transcend	500S 16GB UHS-I MLC MicroSD Card (TS16GUSD500S)
TLC NAND flash SD Cards	
Brand	Model
ADATA	Premier UHS-I 128GB MicroSD Card
Apacer	UHS-I 32GB MicroSD Card (AP32GMCSH10U5-R)
Lexar	High-Performance 633X UHS-I 64GB MicroSD Card
Patriot	LX UHS-I 32GB MicroSD Card (PSF32GLX1MCH)
Samsung	PRO Endurance UHS-I 128GB MicroSD Card (MB-MJ128GA/CN)
	EVO Plus UHS-I 32GB MicroSD Card
SanDisk	High Endurance UHS-I 32GB MicroSD Card (SDSDQQ-032G-G46A)
	Ultra UHS-I 32GB MicroSD Card (SDSQUAR-032G-GN6MN)
Toshiba	M203 UHS-I 32GB Micro SD Card (THN-M203K0320A2)
Transcend	300S UHS-I 256GB MicroSD Card (TS256GUSD300S-A)

Note: Using SD cards of UHS-I and MLC NAND flash are strongly recommended, which have a superior lifetime when compared to others.