

3200 Series



Hager 3200 Series Grade 2 deadlock provides a perfect combination of value and performance and is the ideal choice of lock for typical commercial applications. Our 3200 Series is an economical alternative to Grade 1 when Grade 1 is not required. It is a perfect complement to our 3500 Series for extra protection against break-in and is backed by a lifetime warranty.





3200 SERIES - HOW TO ORDER

3214 2-3/4" US26D US26 SCC KD ASA 6PKEY

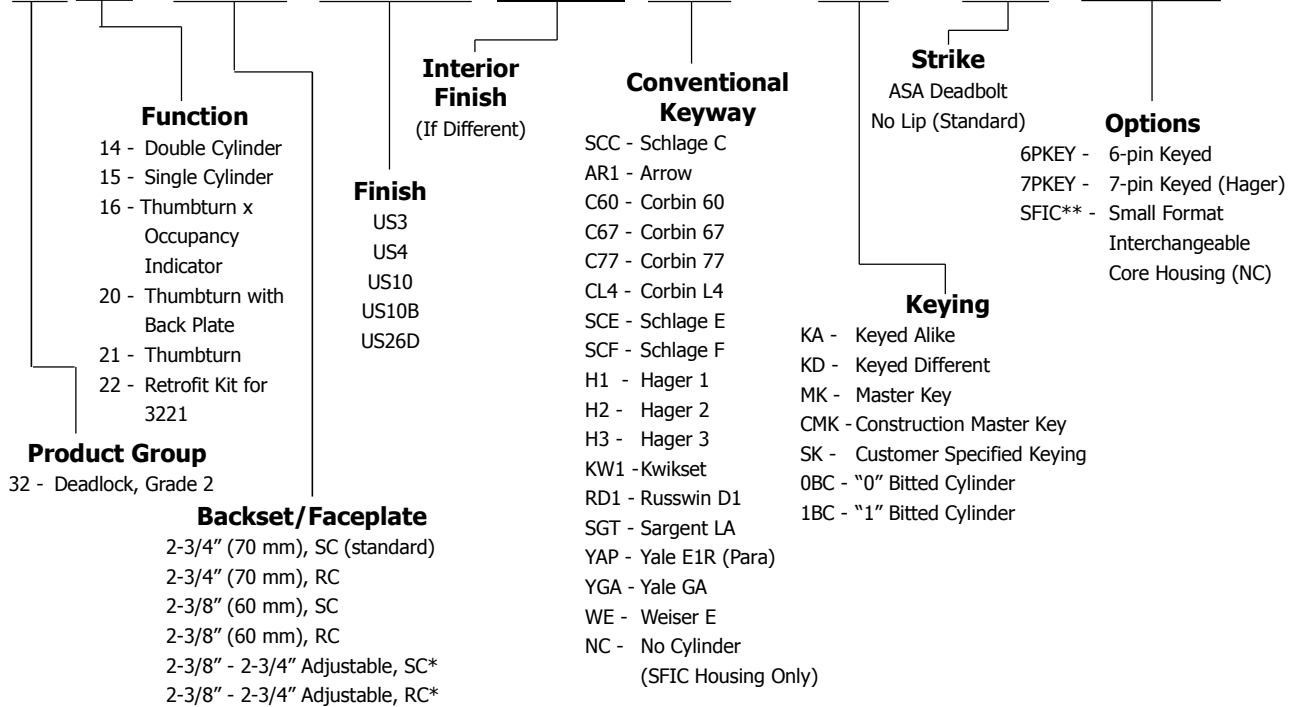





Notes:
 1. If masterkeyed, include completed master key form sheet with order (available on page 88 or www.hagerco.com).
 2. For additional keying information, please refer to cylinder, core, and keying section of catalog (page 73).

* Adjustable backset deadbolts supplied with 3220 and 3221.
 ** Small format interchangeable core sold separately. Available in Best Keyways (A Standard), or Hager Keyways (optional).

Ordering example: 3214 2-3/4" US26D NC SFIC

3200 SERIES FUNCTION CHART

Function	Function No.	Function Description	ANSI No.
 Double Cylinder	14	Deadbolt thrown or retracted by key from either side. Bolt automatically deadlocks when fully thrown.	E2142
 Cylinder x Thumbturn	15	Deadbolt thrown or retracted by key from outside or by inside thumbturn. Bolt automatically deadlocks when fully thrown.	E2152
 Thumbturn x Occupancy Indicator	16	Deadbolt operated by thumbturn inside, emergency override key outside. Outside indicator displays "In Use" when deadbolt is thrown and "Vacant" when deadbolt is retracted.	_____
 Thumbturn w/ Blank Plate (no cylinder)	20	Deadbolt thrown or retracted by thumbturn only. Outside blank plate. Bolt automatically deadlocks when fully thrown.	E21112
 Thumbturn Only (no cylinder)	21	Deadbolt thrown or retracted by thumbturn only. No outside trim. Bolt automatically deadlocks when fully thrown.	E2192

Note: 3222 available for retrofit applications, converting a 3221 into a 3220.



3200 SERIES - GRADE 2 DEADLOCK - AUXILIARY

WARRANTY

Lifetime warranty

FEATURES

- Non-handed
- Conventional cylinder or Small Format Interchangeable Core option available

Certifications:

- BHMA Certified ANSI A156.5 Grade 2
- ANSI A250.13 Severe Windstorm Resistant Component
- UL/cUL Listed for all functions up to 3 hours for "A" label single doors
- UL10C Positive Pressure Rated
- UL10B Neutral Pressure Rated
- ADA - Thumbturn

Options:

- Split finish
- Additional deadbolts and strikes available

SPECIFICATIONS

Standard Door Prep:

- Cylinder hole: 2-1/8" (54 mm) diameter (bore)
- Latch hole: 1" (25 mm) diameter (cross bore)

Exposed Trim:

Wrought brass, bronze or stainless steel

Mechanism:

Steel, zinc dichromate plating

Keys:

Two operating keys supplied per lock

Cylinders/Cores:

- Brass - Keyed Different - Schlage C Keyway standard
- Cylinder drilled 6-pin, Keyed 5-pin - Standard
- Other keying options, including keyed 6-pin, available from the factory (see Cylinder, Core and Keying section)
- Zero bit cylinders will be 6 pin keyed – standard
- Small Format Interchangeable Core option available
- SFIC uncombined or combined, brass 6- or 7-pin cores sold separately

Door Thickness:

- 1-3/4" (45 mm) only - 3214 SFIC and 3216
- 1-3/8" - 1-3/4" (35 mm - 45 mm) - Standard
- 2" - 2-1/4" (51 mm - 57 mm) available for conventional cylinder only - Must specify

Backset:

- 2-3/4" (70 mm) - Standard
- 2-3/8" (60 mm) - Optional
- 2-3/8" - 2-3/4" adjustable backset supplied with 3220 and 3221 (not available on 3214 or 3215)

Latchbolt:

- 1" (25 mm) Throw - Brass with concealed hardened steel roller to prevent sawing or cutting
- 1-1/8" x 2-1/4" (29 mm x 57 mm) square corner faceplate

Strikes:

- 3930 Square Corner, 1-1/8" x 2-3/4" (29 mm x 70 mm) with dustbox - Standard
- 3929 ASA Deadbolt Strike - Optional

Functions:

14 Double Cylinder, 15 Cylinder x Thumbturn, 16 Thumbturn x Occupancy Indicator, 20 Thumbturn w/ Blank Plate, 21 Thumbturn Only

Notes:

3222 retrofit kit available for use with 21 function

FINISHES

US3, US4, US10, US10B, US26D, US32, US32D

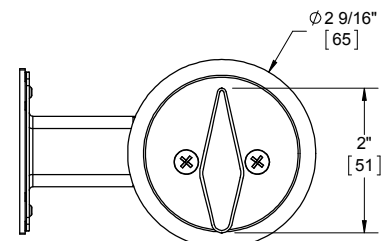
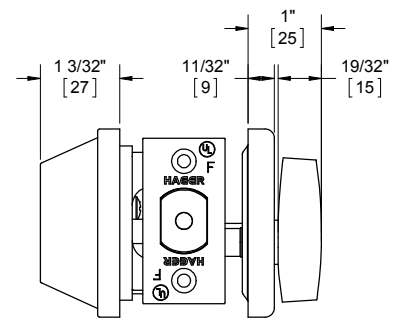



3200 SERIES LATCHBOLTS

3200 SERIES STRIKES



3940
2-3/4" (70 mm) Backset Latchbolt - Standard

- Square and round corner available
- 1-1/8" x 2-1/4" (29 mm x 57 mm) faceplate
- Round corner not available in US32/32D

3941
2-3/8" (60 mm) Backset Latchbolt - Optional

- Square and round corner available
- 1" x 2-1/4" (25 mm x 57 mm) faceplate
- Round corner not available in US32/32D



3942
2-3/8" (60 mm) - 2-3/4" (70 mm) Adjustable Backset Latchbolt - Standard for 3220 and 3221

- Square and round corner available
- 1-1/8" x 2-1/4" (29 mm x 57 mm) faceplate - Standard
- 1" x 2-1/4" (25 mm x 57 mm) faceplate - Optional
- Round corner not available in US32/32D



3929
ASA Deadbolt Strike - Optional
1-1/4" x 4-7/8" (32 mm x 124 mm)



3930
Strike Plate - Standard
• 1-1/8" x 2-3/4" (29 mm x 70 mm)
• Dust box included

