

*Operating instructions*



## Inspection Light LED

ATEX-EHL-1123-LED-50-EPP

## Contents

1	General Information .....	3
1.1	Manufacturer .....	3
1.2	Information regarding the operating instructions .....	3
1.3	Conformity with standards and regulations .....	3
2	Explanation of the symbols .....	3
2.1	Symbols in these operating instructions .....	3
2.2	Warning notes .....	4
2.3	Symbols on the device .....	4
3	Safety notes .....	4
3.1	Operating instructions storage .....	4
3.2	Safe use .....	5
3.3	Modifications and alterations .....	5
4	Function and device design .....	5
5	Technical data .....	6
6	Transport and storage .....	7
7	Mounting and installation .....	8
7.1	Dimensions / fastening dimensions .....	8
7.2	Mounting / dismounting, operating position .....	9
7.3	Installation .....	9
8	Commissioning .....	10
9	Maintenance and repair .....	10
9.1	Maintenance .....	10
9.2	Repair .....	11
9.3	Returning the device .....	11
10	Disposal .....	11
11	Accessories and Spare parts .....	11

## 1 General Information

### 1.1 Manufacturer

Larson Electronics, LLC.  
9419 US-HWY 175  
Kemp, Texas 75143  
U.S.A.

Phone: 800-369-6671  
Fax: 903-498-3364  
Internet: [www.larsonelectronics.com](http://www.larsonelectronics.com)  
E-mail: [sales@larsonelectronics.com](mailto:sales@larsonelectronics.com)

### 1.2 Information regarding the operating instructions

ID-No.: ATEX-EHL-1123-LED-50-EPP





The original instructions are the English edition.  
They are legally binding in all legal affairs.

### 1.3 Conformity with standards and regulations

See certificates and EC Declaration of Conformity.

## 2 Explanation of the symbols



### 2.1 Symbols in these operating instructions

Symbol	Meaning
	Tips and recommendations on the use of the device
	General danger
	Danger due to explosive atmosphere
	Danger due to energised parts



## 2.2 Warning notes

Warning notes must be observed under all circumstances, in order to minimize the risk due to construction and operation. The warning notes have the following structure:

- Signalling word: DANGER, WARNING, CAUTION, NOTICE
- Type and source of danger/damage
- Consequences of danger
- Taking countermeasures to avoid the danger/damage

	<b>DANGER</b>
	Danger to persons Non-compliance with the instruction results in severe or fatal injuries to persons.
	<b>WARNING</b>
	Danger to persons Non-compliance with the instruction can result in severe or fatal injuries to persons.
	<b>CAUTION</b>
	Danger to persons Non-compliance with the instruction can result in light injuries to persons.
<b>NOTICE</b>	
Avoiding material damage Non-compliance with the instruction can result in material damage to the device and / or its environment.	

## 2.3 Symbols on the device

Symbol	Meaning
	CE marking according to the currently applicable directive.
	According to marking, device approved for hazardous areas.

## 3 Safety notes

### 3.1 Operating instructions storage

- Read the operating instructions carefully and store them at the mounting location of the device.
- Observe applicable documents and operating instructions of the devices to be connected.

### 3.2 Safe use



- Read and observe the safety notes in these operating instructions!
- Observe characteristic values and rated operating conditions on the rating and data plates!
- Observe additional information plates on the device!
- Use the device in accordance with its intended and approved purpose only!
- We cannot be held liable for damage caused by incorrect or unauthorized use or by non-compliance with these operating instructions.
- Before installation and commissioning, make sure that the device is not damaged!
- Work on the device (installation, maintenance, overhaul, repair) may only be carried out by appropriately authorized and trained personnel.

### 3.3 Modifications and alterations

	<b>DANGER</b>
	<p>Explosion hazard due to modifications and alterations to the device! Non-compliance results in severe or fatal injuries.</p> <ul style="list-style-type: none"> <li>• Do not modify or alter the device. No liability or warranty for damage resulting from modifications and alterations.</li> </ul>

## 4 Function and device design

The device can be used in hazardous areas of Zones 1, 2, 21, 22 and in the safe area. The inspection light 6149 is designed for use as a portable workplace light. The optional mounting brackets allow the inspection light to also be used as a machine light.

	<b>WARNING</b>
	<p>Danger if used in aggressive ambient conditions! The explosion protection is impaired!</p> <ul style="list-style-type: none"> <li>• Do not use when exposed to kerosene, ammonia and phosphorus vapour.</li> <li>• The enclosure can be damaged.</li> </ul>
	<b>DANGER</b>
	<p>Explosion hazard due to improper use! Non-compliance results in severe or fatal injuries.</p> <ul style="list-style-type: none"> <li>• Use the device only according to the operating conditions described in these operating instructions.</li> </ul>

## 5 Technical data

### Explosion Protection

#### Global (IECEX)

Gas and dust

IECEX PTB 07.0018

Ex d IIC T\* Gb

Ex tb IIIC T\* °C Db

\* temperature classes and surface temperatures see below

#### Europe (ATEX)

Gas and dust

PTB 07 ATEX 1009

E II 2 G Ex d IIC T\* Gb

E II 2 D Ex tb IIIC T\* °C Db

\* temperature classes and surface temperatures see below

#### Certifications and certificates

Certificates

IECEX, ATEX, Brazil (INMETRO), Kazakhstan (TR), Russia (TR), Belarus (TR)

#### Surface temperature and temperature class

Version	Temperature class	Surface temperature
ATEX-EHL-1123...-....	T4	100 °C

### Technical Data

#### Electrical data

Version

(110 ... 240 V) 110 ...

Rated operational voltage

240 (± 10 %) V AC / DC, 50 / 60 Hz

Nominal operational current

110 V      0.13 A

240 V      0.07 A

#### Luminous characteristics

Version

6149/2-5 (110 ... 240 V)

Lamps

LED

Luminous flux

approx. 1,000 lm

Luminous Intensity

285 lux in 1 m distance

**Technical Data**

Ambient conditions						
Ambient temperature		<b>Cable</b>		<b>6149/2-2 (12V)</b>	<b>6149/2-3 (24 ... 48 V)</b>	<b>6149/2-5 (110 ... 240 V)</b>
		H07RN-F; 2 x 1,5 mm <sup>2</sup>	T4 T6	-40 ... +40 °C	-40 ... +60 °C -40 ... +40 °C	-30 ... +60 °C -30 ... +40 °C
		HXSLHXÖ-J; 2 x 1,5 mm <sup>2</sup>	T4 T6	-40 ... +40 °C	-40 ... +60 °C -40 ... +40 °C	-30 ... +60 °C -30 ... +40 °C
		(N)SSHÖU 1kV; 2 x 1,5 mm <sup>2</sup>	T4 T6	-40 ... +40 °C	-40 ... +60 °C -40 ... +40 °C	-30 ... +60 °C -30 ... +40 °C
		RADOX, MFH-S B; 2 x 1,5 mm <sup>2</sup>	T4 T6	-40 ... +40 °C	-40 ... +60 °C -40 ... +40 °C	-30 ... +60 °C -30 ... +40 °C
		The luminaire must be switched on above -40 °C.				
Mechanical data						
Degree of protection		IP66 / IP67				
Protection class		II				
Material						
Enclosure tube		Polycarbonate				
Grip		Aluminium				
Sealing cap		Aluminium				
Rubber grip		NBR / PVC (EPDM)				
Suspension hook		NBR / PVC (EPDM)				
Mounting / Installation						
Cable glands		CMP cable gland for rubber case-, Thermflex- and wire mesh lead				
Connection line		<b>Designation</b>		<b>Application</b>		
		H07RN-F, d 8.8 ... 11 mm, 2 x 1.5 mm <sup>2</sup>		Standard		
		Gifas Thermflex cable, HXSLHXÖ-J, d 7.7 ... 10 mm, 2 x 1.5 mm <sup>2</sup>				
		(N)SSHÖU 1kV, d 8.7 ... 9 mm, 2 x 1.5 mm <sup>2</sup>		Voltage-proof up to 1kV		
		RADOX, MFH-S B, d 6 ... 7 mm, 2 x 1.5 mm <sup>2</sup>		Offshore		

## 6 Transport and storage

- Transport and store the device only in the original packaging.
- Store the device in a dry place (no condensation) and vibration-free.
- Do not drop the device.

## 7 Mounting and installation

	<b>DANGER</b>
<p>Explosion hazard due to incorrect installation of the device!                  Non-compliance results in severe or fatal injuries.</p> <ul style="list-style-type: none"> <li>• Carry out installation strictly according to the instructions and national safety and accident prevention regulations to maintain the explosion protection.</li> <li>• Select and install the electrical device so that explosion protection is not affected due to external influences, i.e. pressure conditions, chemical, mechanical, thermal and electric impact such as vibration, humidity and corrosion (see IEC/EN 60079-14).</li> <li>• The device must only be installed by trained qualified personnel who is familiar with the relevant standards.</li> </ul>	

### 7.1 Dimensions / fastening dimensions

Dimensional Drawings (All Dimensions in mm [inches]) - Subject to Alterations

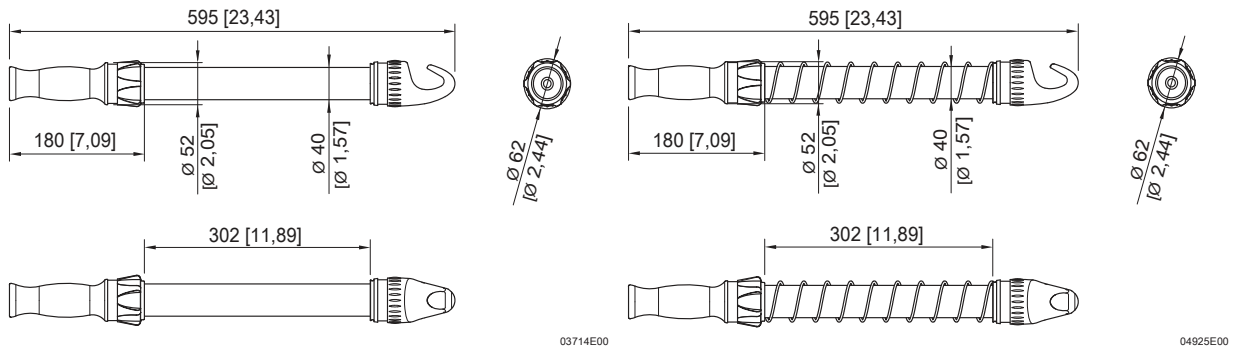

Inspection light without wire guard

Inspection light with wire guard

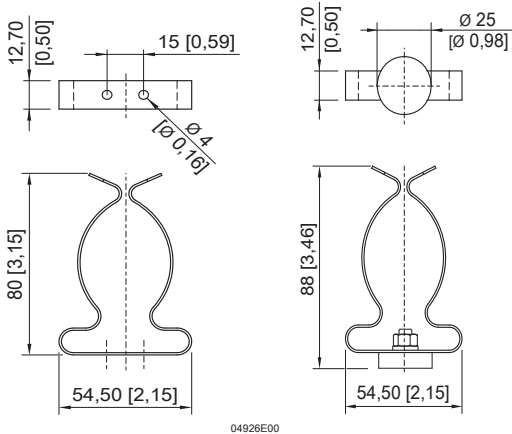

Mounting bracket

Mounting bracket and magnet



## 7.2 Mounting / dismounting, operating position

### 7.2.1 Wire Guard Assembly

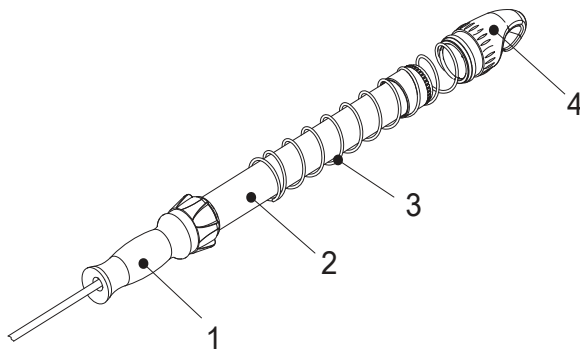

05337E00

- remove the suspension hook (4) from the enclosure tube (2).
- push the wire guard (3) over the enclosure tube.
- push the first coil of the wire guard over the lip of the grip (1)
- push the suspension hook back onto the enclosure tube and push the last coil of the wire guard over the lip of the suspension hook when doing so.
- wire guard is now fitted.

### 7.2.2 Wall mounting

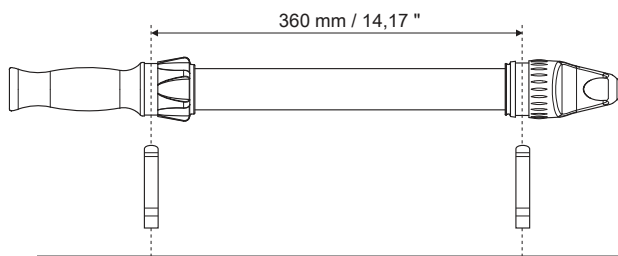





05342E00

- fix the mounting brackets to the wall at a spacing distance of 360 mm.
- clip the inspection light into the mounting brackets.
- wall mounting is complete.

## 7.3 Installation

### 7.3.1 Electrical connections

<b>WARNING</b>	
	<p>Danger due to wrong plugs! The explosion protection is impaired!</p> <ul style="list-style-type: none"> <li>• Only use plugs, which are approved for use in the relevant zone.</li> </ul>
	<p>The light is delivered with a connection cable. A standard CE connector must be used for operation. When selecting the connector observe the IP level of protection!</p>
	<p>All versions can be operated with a cable length of up to 100 m.</p>
	<p>It is not permitted to extend the connection cable.</p>

- Installation of the plugs should be performed in accordance with the corresponding operating instructions.

## 8 Commissioning

	DANGER
	<p>Explosion hazard due to incorrect installation! Non-compliance results in severe or fatal injuries.</p> <ul style="list-style-type: none"> <li>Check the device for proper installation and function before commissioning.</li> <li>Comply with the national regulations.</li> </ul>

- Make sure that the plug is fitted correctly.
- Check that the cable is clamped properly.
- Inspect cable glands for damage.
- Check the light for visible damage.

## 9 Maintenance and repair

	WARNING
	<p>Risk of electric shock or malfunctioning of the device due to unauthorized work! Non-compliance can result in severe injuries and material damage.</p> <ul style="list-style-type: none"> <li>Work performed on the device must only be carried out by appropriately authorized and qualified electricians.</li> </ul>

### 9.1 Maintenance

	<p>Observe the relevant national regulations in the country of use.</p>
---	---

- Determine the type and extent of inspections in compliance with the relevant national regulations.
- Adapt inspection intervals to the operating conditions.

The following tests and measures must be carried out during regular maintenance.

<b>Check</b>	<b>Measures</b>
the permissible ambient temperature	If exceeding the permissible ambient temperature or falling below the device must be taken out of operation.
the enclosure components for formation of cracks and damage.	Replace the exchangeable enclosure components. If the enclosure components are non-exchangeable, the device must be taken out of operation.
its intended use	If the device is not used according to its intended use, it must be taken out of operation.

### 9.1.1 Cleaning

- Clean the device only with a cloth, brush, vacuum cleaner or similar items.
- When cleaning with a damp cloth, use water or mild, non-abrasive, non-scratching cleaning agents.
- Do not use aggressive detergents or solvents.

## 9.2 Repair

	<b>DANGER</b>
	<p>Explosion hazard due to improper repair! Non-compliance results in severe or fatal injuries.</p> <ul style="list-style-type: none"> <li>• Repair work on the devices must be performed only by manufacturer.</li> </ul>

## 9.3 Returning the device

Contact manufacturer.

## 10 Disposal

- Observe national and local regulations and statutory regulation regarding disposal.
- Separate materials when sending it for recycling.
- Ensure environmentally friendly disposal of all components according to the statutory regulations.

## 11 Accessories and Spare parts

<b>NOTE</b>	
<p>Malfunction or damage to the device due to the use of non-original components. Non-compliance can result in material damage.</p> <ul style="list-style-type: none"> <li>• Use only original accessories and spare parts.</li> </ul>	
	<p>For accessories and spare parts, contact manufacturer or see <a href="http://www.larsonelectronics.com">www.larsonelectronics.com</a>.</p>