

TITLE:
EXPCMR-ALG-1080P-50FT-1227

PROPRIETARY AND CONFIDENTIAL
THE INFORMATION CONTAINED IN THIS DRAWING IS THE SOLE PROPERTY OF LARSON ELECTRONICS LLC. ANY REPRODUCTION IN PART OR AS A WHOLE WITHOUT THE WRITTEN PERMISSION OF LARSON ELECTRONICS LLC IS PROHIBITED.

DIMENSIONS ARE IN INCHES		DRAWN	NAME	SIZE	DWG. NO.	REV
MATERIAL		CHECKED	CHRIS THAUER	A		
DO NOT SCALE DRAWING			JEREMY BLANKENSHIP			
				SCALE: 1:3	SHEET 1 OF 2	

5

4

3

2

1

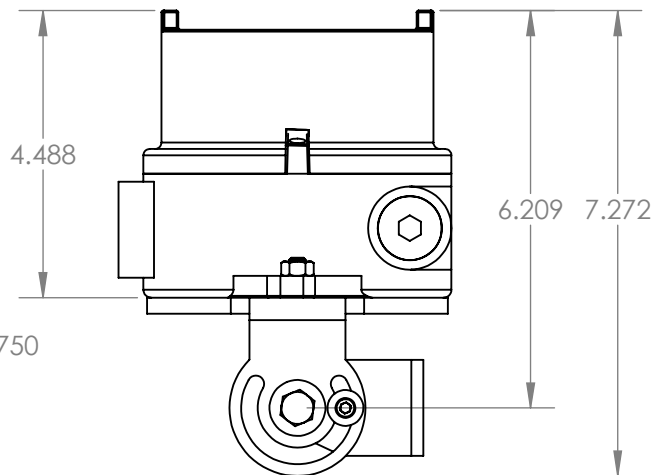
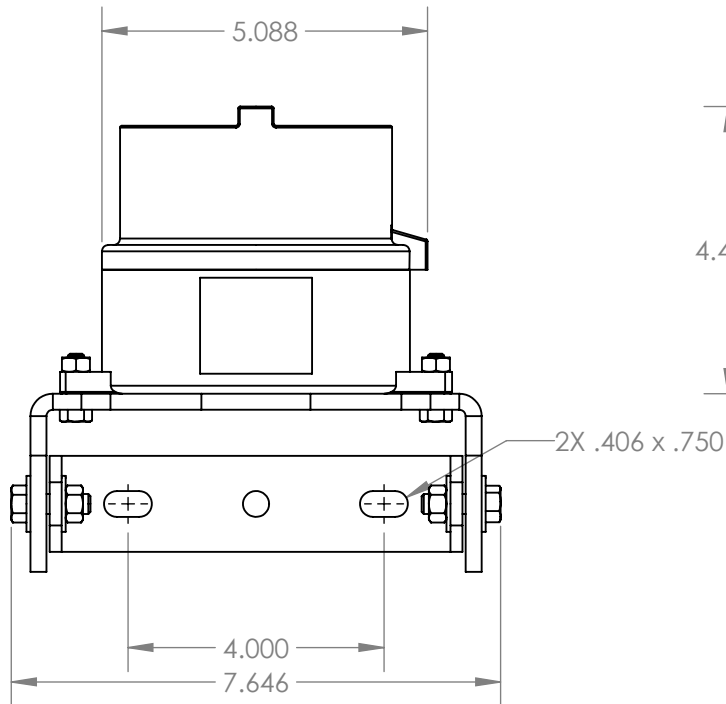
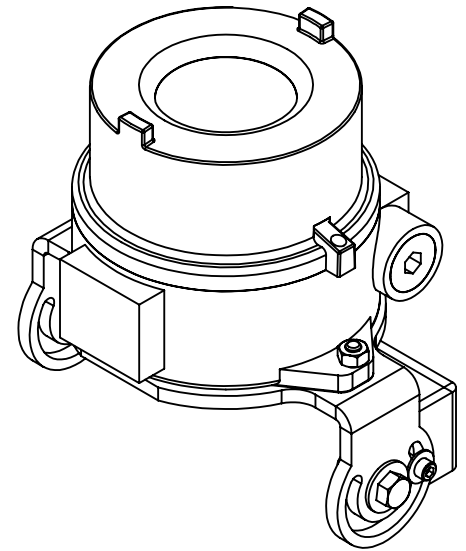
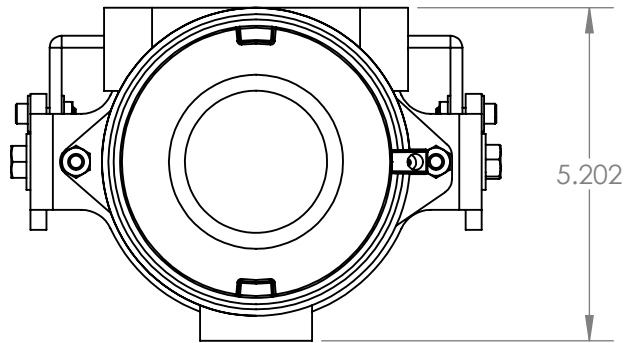

TITLE:
EXPCMR-ALG-1080P-50FT-1227

PROPRIETARY AND CONFIDENTIAL
THE INFORMATION CONTAINED IN THIS DRAWING IS THE SOLE PROPERTY OF LARSON ELECTRONICS LLC. ANY REPRODUCTION IN PART OR AS A WHOLE WITHOUT THE WRITTEN PERMISSION OF LARSON ELECTRONICS LLC IS PROHIBITED.

DIMENSIONS ARE IN INCHES		DRAWN	NAME	SIZE	DWG. NO.	REV
MATERIAL		CHECKED	CHRIS THAUER	A		
DO NOT SCALE DRAWING			JEREMY BLANKENSHIP			
				SCALE: 1:3	SHEET 2 OF 2	

5

4

3

2

1