

EXPCMR-ALG-1080P-1227

Explosion Proof 1080p Analog Portable Observation Camera

The EXPCMR-ALG-1080P-1227 camera features a 1/2.7" CMOS image sensor that delivers HD video resolution over RG59 coax or any standard analog CCTV cabling up to 1600 ft. This camera must connect to an HD-TVI compatible DVR, such as an HVR. This HD video camera is ideal for security applications that require a high level of detail, such as facial recognition.

Features

- CMOS image sensor
- HD-TVI technology produces 1920 × 1080 (1080p) 3.6 mm wide angle (90°) lens captures images over large areas
- HD-TVI technology transmits zero latency HD video resolution over coax cabling
- Up the Cable (UTC) On Screen Display (OSD) configuration setup and control through HD-TVI DVR
- Built-in IR with range up to 65 ft in the dark
- True day/night (ICR) captures sharp, clear images in low light and at night
- 14 °F ~ 122 °F temperature operating range
- IP66 weather-rated housing

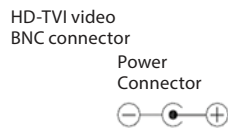
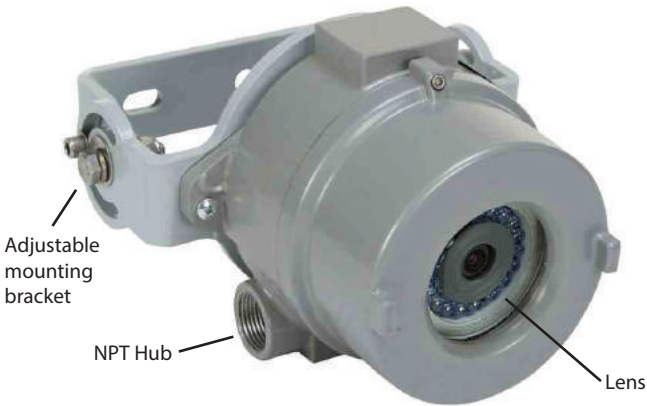

Camera drop cable connectors

What's in the box

- Camera assembly
- This instruction guide

Tools you need

To install the camera, you will need:

- 12 Vdc power source. See [Specifications](#) for wattage requirement.
- Tools and additional fasteners (may be required) for mounting the camera
- Phillips screwdriver
- Video and power extension cable

Installation

Before installation:

- Make sure that the device is in good condition and all the assembly parts are included.
- Check the specification of the products for the installation environment.
- Make sure that the wall or the ceiling is strong enough to withstand 3 times the weight of the camera.
- To avoid fire or shock hazard, use only UL listed power supplies. Verify that the power supply will provide the rated voltage and wattage for the camera. See the **Specifications** section.

During installation:

- **Camera Lens:** Handle the camera carefully to prevent scratching or soiling the lens. If the lens or IR array shield becomes soiled, clean it only with approved products. See the **Cleaning** section.
- **Monitor impedance:** Set the monitor impedance switch to 75 Ω.
- **Power supply: Camera drop cable:** The camera drop cable includes two connectors:
 - **Video BNC connector:** For transmission of the video signal across a coax (75 Ω) extension cable.
 - **Power connector:** When applying Vdc power, observe the power polarity. See the drop cable photo to the left for the connector polarity configuration.

Step 1. Mounting the camera

These cameras can be mounted on a wall or ceiling that has sufficient strength to support it.

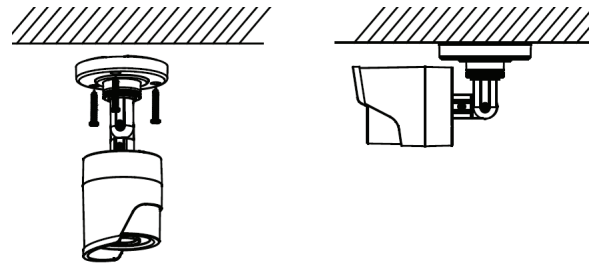

Typical ceiling mounting

1. Mark the location of the screws that anchor the mounting base to the mounting surface. See the note above. If you are routing the drop cable through mounting surface, also mark the position of the hole for the drop cable.
2. Drill holes for the screws that anchor the base to the mounting surface. The mounting hardware provided is appropriate for most surfaces. However, depending on the surface materials, more appropriate fasteners may be required.
3. Drill a 3/4" hole through the mounting surface for the drop cable, if necessary.
4. Route the drop cable through the hole in the mounting surface, or through the cable guide in the mounting base, then attach the camera assembly to the surface using the appropriate fasteners.
5. Connect the camera drop cable to video and power extension cables.
6. Connect the other end of the video extension cable to a video monitoring device, such as a HD-TVI capable DVR.

NOTE Drop cable connectors are not waterproof.

7. Connect the other end of the power extension cable to a 12 Vdc power source. Observe the polarity of the cable shown in the photo on page 1 of this guide.

Step 2. Camera adjustments

1. Apply power to the camera.

- Verify that video from the camera can be seen on the HD-TVI DVR (HVR) monitor.
- While observing video from the camera, loosen the mounting bracket pan, elevation and horizontal line adjustment lock screws, point the camera at your surveillance target, and then tighten adjustment lock screws and lock nut to hold the camera in position.

The mounting bracket pan adjustment can be made after loosening the lock nut (see the photo below). Use a Phillips #1 screwdriver for the elevation and horizontal line adjustment lock screws.



Camera mounting bracket adjustment

Step 3. Open the OSD menu

The On Screen Display (OSD) provides configuration options for refining the performance of the camera. It also can be used to block sensitive portions in the field of view (Privacy). You can open the OSD menu system from either the HVR Live View display or through remote login to the HVR.

Opening the OSD Menu through the HVR

To open the OSD menu on the HVR monitor:

- Open the HVR Live View screen, and then click inside the screen where the PTZ camera video image is displayed. See below.

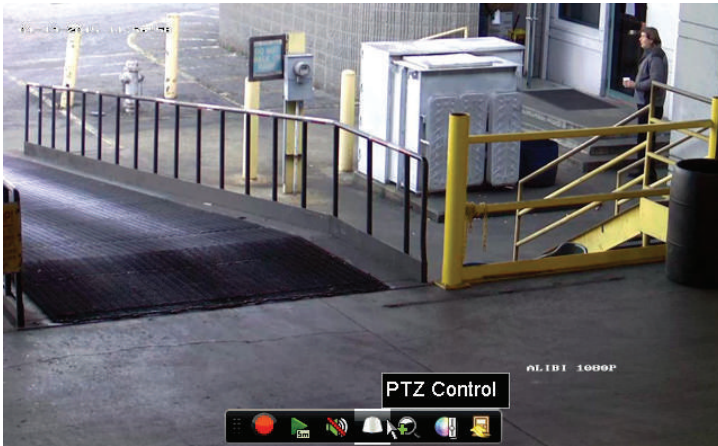

- Click the **PTZ Control** icon in the Quick Setting Toolbar. The PTZ camera Live View window will expand to full screen and the pop-up window shown below will open.



- In the **PTZ Control** panel pop-up window, click the **Menu** icon on the **Configuration** line.



- Drag the PTZ Control window to a position where it doesn't cover the OSD menu (such as the lower-right corner).

Opening the OSD Menu through remote login to the HVR

To open the OSD menu during a remote login to the HVR:

- After logging into the HVR, open the PTZ camera in a single Live View window.

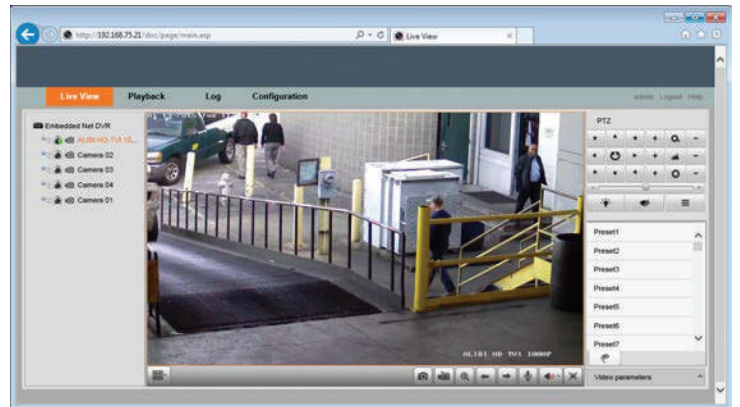

- In the PTZ control panel, scroll down the Preset list to **Preset95**, click the entry to highlight it, and then click the **Call** icon. See below. The OSD **MAIN MENU** screen will open.

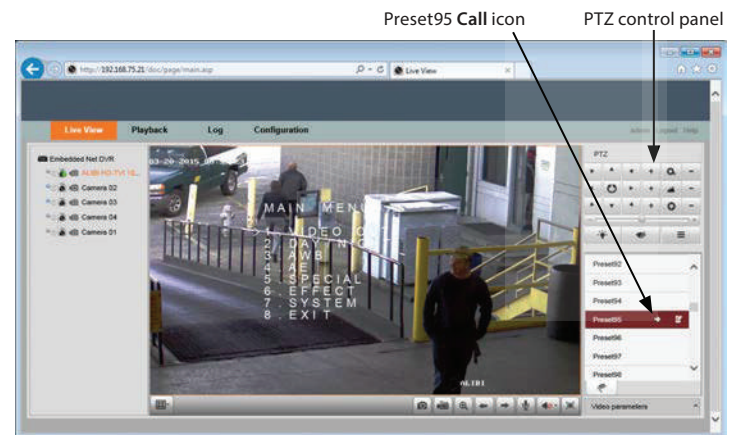

OSD menu navigation

For the HVR: Navigation and settings in the OSD are made through direction keys and the **Iris +** and **Iris -** buttons in the HVR PTZ Control panel. See below.



Direction keys
Iris+ Iris-
HVR PTZ Control panel

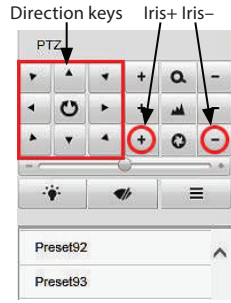

Direction keys
Iris+ Iris-
HVR remote access PTZ control panel

For remote access to the HVR: Navigation and settings in the OSD are made through direction keys and the **Iris +** and **Iris -** buttons in the HVR PTZ control panel. See above.

The function of the directional keys and Iris buttons are defined in the table below.

Keys	Function
▲	Move up in the parameter list
▼	Move down in the parameter list.
◀	Move to previous page, field, or move the camera left.
▶	Move to next page, field, or move field right.
Iris+ (OPEN)	Set parameter value, or open sub-menu
Iris- (CLOSE)	Cancel change of parameter.

Step 4. Use the OSD menu to configure the camera

The abbreviated OSD menu tree is shown below.

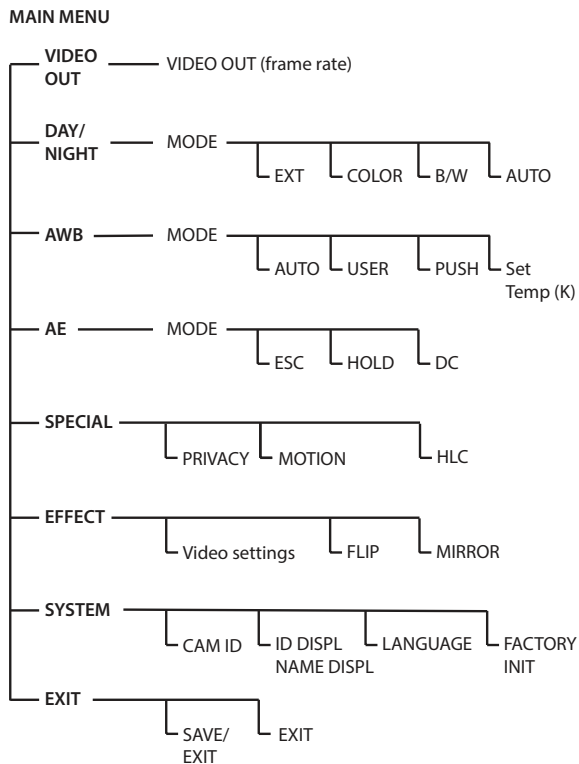

OSD Definitions:

AE: Set automatic exposure mode.

AGC (Automatic Gain Control): Higher gain increases brightness but also increases any noise. When a high gain level is applied, higher noise levels are seen.

AWB (Automatic White Balance): The function to search for the color which is matched well with the ambient environment.

BLC (Back Light Compensation): This feature enables the camera to compensate for strong back light conditions in a selected area of the image.

DELAY TIME (DAY/NIGHT): This option specifies the switching time from color to B/W and B/W to color.

D TO N, N TO D: This option sets the AGC brightness when switching from day to night and night to day.

FACTORY INIT: Select FACTORY to reset the camera configuration to the factory default values.

FLICKER: Feature used to reduce noise in the image produced by AC current at 60 Hz.

FLIP: This feature provides an image that is reflected vertically.

HLC (High Light Compensation): HLC feature is used to identify and suppress the strong light sources that usually flare across a scene. It improves the detail of the image that would normally be hidden.

LSC (Lens Shading compensation): This feature brightens the image in shaded areas.

MIRROR: This feature provides an image that is reflected horizontally.

MOTION: The MOTION feature allows you to quickly identify areas of the image where motion is detected.

PRIVACY: The PRIVACY feature allows you to block areas of the image from being seen. Use the SX, EX, SY, and EY parameters to set the right, left, up and down limits of the privacy area.

SAVE/EXIT: Save the current configuration settings and close the OSD. The settings are retained even after if the camera is powered off, and then on again.

SX, EX, SY, EY: Sets the start and end X boundaries and the start and end Y boundaries of a PRIVACY or MOTION area.

Examples

The following examples provided demonstrate how to use the menus to perform basic configuration tasks. For clarity, the background video image was removed in the screens included here.

Example 1: Change video frame rate

The video frame rate parameter can be set using the Main Menu VIDEO OUT submenu. To change the setting:

1. Open the OSD Main Menu (see "Step 3. Open the OSD menu" on page 2).

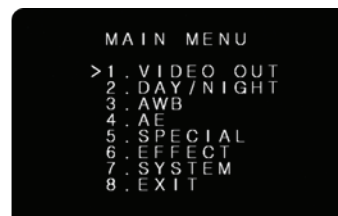

2. With the > marker at the VIDEO OUT entry, click the **Iris +** button to open the VIDEO OUT submenu (see the right screen above).
3. With the > marker at the FRAME RATE entry, click the ◀ or ▶ button to decrease or increase the frame rate.
4. Click the ▼ button to position the > marker at RETURN, and then click the **Iris +** button to return to the previous menu (MAIN MENU).
5. Click the ▲ button to position the > marker at EXIT, and then click the **Iris +** button to open the EXIT submenu.



- Click the ▼ or ▲ button to position the > marker at either SAVE/EXIT or EXIT, and then click the Iris + button.

NOTE

SAVE/EXIT: Use this option if you want to retain the setting. It can be changed at any time.
EXIT: Use this option if you want to retain the setting temporarily. If the camera is powered off, the new setting is lost.

Example 2: Change the camera video settings

Video settings for the camera are configured in the EFFECT submenu. You can also flip (vertical reflection) and/or mirror (horizontal reflection) the image in this menu. To change the setting:

- Open the OSD Main Menu (see “Step 3. Open the OSD menu” on page 2).

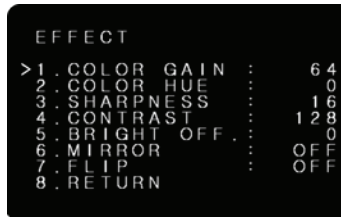

- Click the ▼ button to position the > marker at EFFECT, and then click the Iris + button to open the EFFECT submenu.
- Click the ▼ or ▲ button to position the > marker at the parameter you want to change, and then click the ◀ or ▶ button to decrease or increase the setting. The FLIP and RETURN options are either ON or OFF. The effect of changing the parameter is shown immediately in the video image.
- Repeat the previous step to change other parameter values if necessary.
- Click the ▼ button to position the > marker at RETURN, and then click the Iris + button to return to the previous menu (MAIN MENU).
- Click the ▼ button to position the > marker at EXIT, and then click the Iris + button to open the EXIT submenu.
- Click the ▼ or ▲ button to position the > marker at either SAVE/EXIT or EXIT, and then click the Iris + button.

Cleaning

Clean the camera dome with an approved glass cleaning solution and a lint free cloth.

- Dust can be removed from the unit by wiping it with a soft damp cloth. To remove stains, gently rub the surface with a soft cloth moistened with a mild detergent solution, then rinse and dry it with a soft cloth.
- Remove all foreign particles, such as plastic or rubber materials, attached to the camera housing. These may cause damage to the surface over time.

Specifications

Model	EXPCMR-ALG-1080P-1227
Camera	
Image Sensor	1 / 2.7" Progressive Scan CMOS
Signal System	NTSC
Effective Pixels	1930(H) * 1088(V)
Min. Illumination	0.1 lux @ (F1.2, AGC ON), 0 lux with IR
Shutter speed	1/30 s to 1/50,000 s
Lens	3.6 mm lens, angle of View: 90°
Lens Mount	M12
Day & Night	ICR
Synchronization	Internal synchronization
Video Frame Rate	1080p @ 30 fps
HD Video Output	1 Analog HD output
S / N Ratio	More than 52 dB
Menu	
Camera ID	On/off (0 ~ 255)
AGC	Support
D/N Mode	Color / BW/ Auto / EXT
White Balance	Auto / User / Push / 8000 K / 6000 K / 4200 K / 3000 K
Privacy Mask	On/Off, maximum 2 zones
Motion Detection	On/Off, maximum 4 zones
BLC	Support
Anti-flicker	On / Off
Language	English / Chinese
Function	Digital noise reduction, Mirror
General	
Working Temperature / Humidity	14 °F ~ 122 °F (-10 °C ~ 50 °C)
Humidity	90% or less (non-condensing)
Power Supply	12 Vdc
Power Consumption	Max. 3W
Weather Proof Ratings	IP66
IR Range	Up to 65 ft (20 m)
Communication	Up the coax (OSD control through the HD-TVI DVR)
Protocol:	Coaxitron
Dimensions	Ø2.76" × 5.89" (Ø70 × 149.5 mm)
Weight	0.79 lbs (360 g)

Troubleshooting

Problem	Possible Cause
Nothing appears on the screen	- Check the power connection. - Check the video signal cable connection to the monitor.
The video image is dim or not clear.	- If the camera lens is dirty, clean it with a soft, clean cloth. - Adjust the monitor controls, if necessary. - If the camera is facing a very strong light, change the camera position. - Adjust the lens focus.
The screen is dark.	- Adjust the contrast control of the monitor. - If you have an intermediate device, set the impedance (75 Ω /Hi-Z) properly, and check the cable connections.
The camera is not working properly and the surface of the camera is hot.	- Verify that the camera is correctly connected to an appropriate regulated power source.
The image on the monitor flickers	- Make sure that the camera isn't facing direct sunlight or fluorescent light. - If necessary, change the camera position.



CAUTION Do not use benzene, thinner or other chemical products on the camera assembly; these may dissolve the paint and promote damage of the surfaces. Before using any chemical product, carefully follow the accompanying instructions.