

Platinum HD-TVI Dome Camera 2.1MP CMHD7422-28



Key Features:

- 2.1MP High Definition
- 1920x1080P@30fps
- True Day/Night
- Smart IR
- 65ft(20m) IR distance
- OSD Menu via UTC technology with Platinum TVI DVR
- Aluminum housing
- Vandal-proof
- 3-axis

Dimensions:

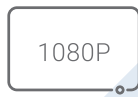
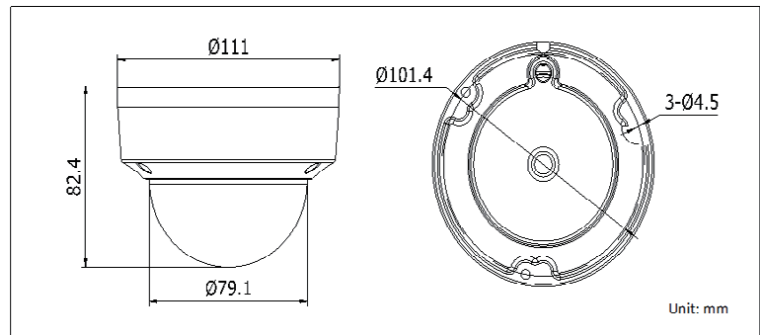

Platinum HD-TVI Dome Camera 2.1MP CMHD7422-28

CAMERA	
Image Sensor	1/2.9" CMOS
Signal System	NTSC/PAL
Effective Pixels	1930(H)*1088(V)
Min. Illumination	0.01 Lux, 0 Lux with IR
Shutter Speed	1/30(1/25) s to 1/50,000 s
Lens	2.8mm Lens Angle of View: 105.8°
Day & Night	ICR
Synchronization	Internal
Video Frame Rate	1080p@30fps/1080p@25fps
HD Video Output	1 HD-TVI Output
S/N Ratio	More than 52dB
MENU	
AGC	Support
D/N Mode	Color/ BW/ Smart
White Balance	ATW/MWB
Language	English
Function	Digital noise reduction, Mirror
GENERAL	
Working Temperature /Humidity	-40 ° F - 140 ° F (-40° C - 60° C) Humidity 90% or less (non-condensing)
Power Supply	DC 12V
Power Consumption	Max. 3W
Weather Proof Ratings	IP66
IR Range	Up to 65ft(20m)
Dimension	φ4.4" x 3.2" (φ111.0 x 82.4mm)
Weight	1.2lb(550g)