



TURBO HD

TVI Turret & Bullet Camera

User Manual

Thank you for purchasing our product. If there are any questions, or requests, please do not hesitate to contact the dealer.

This manual may contain several technical incorrect places or printing errors, and the content is subject to change without notice. The updates will be added to the new version of this manual. We will readily improve or update the products or procedures described in the manual.

Please refer to the product specification for camera parameters and functions.

Regulatory Information

FCC Information

FCC compliance: This equipment has been tested and found to comply with the limits for a digital device, pursuant to part 15 of the FCC Rules. These limits are designed to provide reasonable protection against harmful interference when the equipment is operated in a commercial environment. This equipment generates, uses, and can radiate radio frequency energy and, if not installed and used in accordance with the instruction manual, may cause harmful interference to radio communications. Operation of this equipment in a residential area is likely to cause harmful interference in which case the user will be required to correct the interference at his own expense.

FCC Conditions

This device complies with part 15 of the FCC Rules. Operation is subject to the following two conditions:

1. This device may not cause harmful interference.
2. This device must accept any interference received, including interference that may cause undesired operation.

EU Conformity Statement

CE This product and - if applicable - the supplied accessories too are marked with "CE" and comply therefore with the applicable harmonized European standards listed under the Low Voltage Directive 2006/95/EC, the EMC Directive 2004/108/EC, the RoHS Directive 2011/65/EU.

 2012/19/EU (WEEE directive): Products marked with this symbol cannot be disposed of as unsorted municipal waste in the European Union. For proper recycling, return this product to your local supplier upon the purchase of equivalent new equipment, or dispose of it at designated collection points. For more information see: www.recyclethis.info.

 2006/66/EC (battery directive): This product contains a battery that cannot be disposed of as unsorted municipal waste in the European Union.

See the product documentation for specific battery information. The battery is marked with this symbol, which may include lettering to indicate cadmium (Cd), lead (Pb), or mercury (Hg). For proper recycling, return the battery to your supplier or to a designated collection point. For more information see: www.recyclethis.info.

1 Introduction

1.1 Product Features

This series of camera adopts new generation sensor with high sensitivity and advanced circuit design technology. It features high resolution, low image distortion and low noise, etc., which makes it suitable for surveillance system and image processing system.

- High performance CMOS sensor and high resolution bring high-quality image;
- Low illumination;
- OSD menu, parameters are configurable;
- Support auto white balance, auto gain control, electronic shutter control;
- Support image effect adjustment;
- Unit transmission control;
- Advanced 3-axis design meets different installation requirements.



Cameras in some models do not support OSD menu. For actual operation, please refer to the specification of each model.

1.2 Overview

1.2.1 Overview of Type I Camera

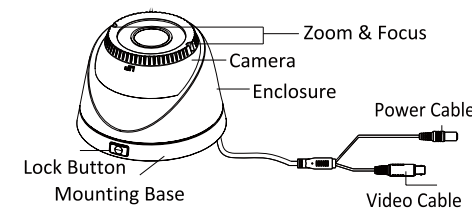

Figure 1-1 Overview of Type I Camera

1.2.2 Overview of Type II Camera

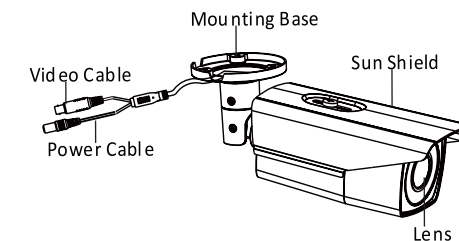

Figure 1-2 Overview of Type II Camera

2 Installation

Before you start:

- Please make sure that the device in the package is in good condition and all the assembly parts are included.
- Make sure that all the related equipment is power-off during the installation.
- Check the specification of the products for the installation environment.
- Check whether the power supply is matched with your power output to avoid damage.
- Please make sure the wall is strong enough to withstand three times the weight of the camera and the mounting.
- If the wall is the cement wall, you need to insert expansion screws before you install the camera. If the wall is the wooden wall, you can use self-tapping screw to secure the camera.
- If the product does not function properly, please contact your dealer or the nearest service center. Do not disassemble the camera for repair or maintenance by yourself.

2.1 Installation of Type I Camera

Steps:

1. Drill the screw holes and the cable hole on the ceiling according to the supplied drill template.

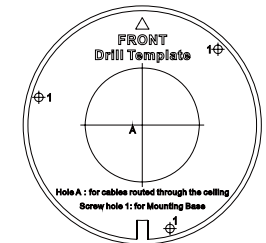

Figure 2-1 The Drill Template

2. Push the lock button to disassemble the camera from the mounting base.

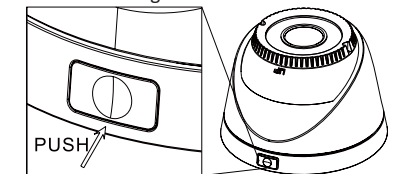

Figure 2-2 Release The Lock Screw

3. Fix the mounting base to the ceiling.
4. Route the cables to the cable hole and connect the corresponding cables.
5. Secure the camera to the mounting base by supplied screws. Keep the word UP on the camera being upright during the installation to make the image showing normally.

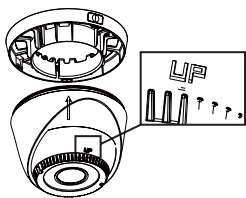

Figure 2-3 Secure the Camera

6. Adjust the camera according to the figure below to get an optimum angle.

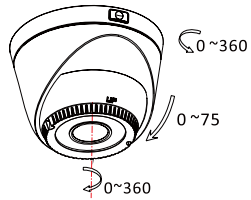

Figure 2-4 Universal Adjustment

7. Use the screwdriver to adjust the ZOOM screw and the FOCUS screw until you get the optimum image.

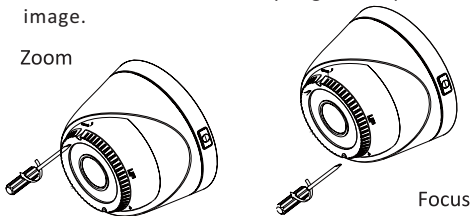

Figure 2-5 Zoom and Focus Adjustment

2.2 Installation of Type II Camera



Both wall mounting and ceiling mounting are suitable for type II bullet camera. Ceiling mounting will be taken as an example in the section. And you can take steps of ceiling mounting as a reference if wall mounting is adopted.

Steps:

1. Drill the screw holes and the cable hole in the ceiling according to the supplied drill template.
2. Hammer the supplied plastic expansion bolt into the screw holes.

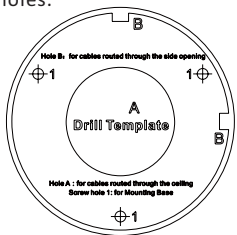

Figure 2-6 Drill Template

3. Route the cables to the cable hole and connect the corresponding cables.
4. Fix the camera to the ceiling with the supplied screws.

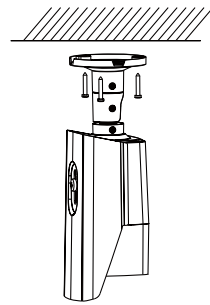

Figure 2-7 Fix the Camera to the Ceiling

5. Adjust the surveillance angle.
 - 1). Loosen No.1 adjusting screw to adjust the pan position (0° ~ 360°).
 - 2). Tighten No.1 adjusting screw.
 - 3). Loosen No.2 adjusting screw to adjust the tilting position (0° ~ 90°).
 - 4). Tighten No.2 adjusting screw.
 - 5). Loosen No.3 adjusting screw to adjust the rotation position (0° ~ 360°).
 - 6). Tighten No.3 adjusting screw.

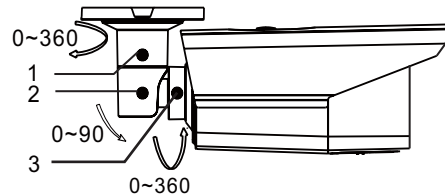

Figure 2-8 3-axis Adjustment

6. Push the focus & zoom adjustment cover upward to move it aside.
7. Use the cover as a screwdriver to adjust the ZOOM screw and the FOCUS screw until you get the optimum image.

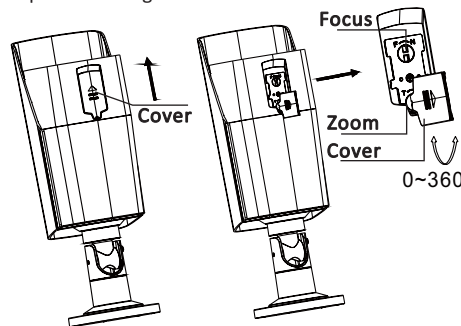

Figure 2-9 Zoom and Focus Adjustment

3 Menu Operation

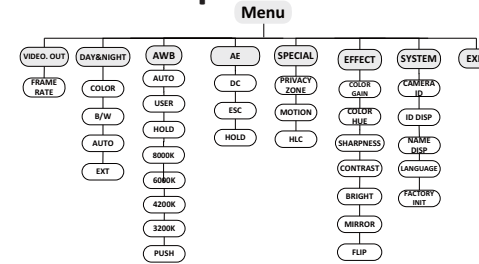

Figure 3-1 Main Menu

A coaxial camera controller (purchase separately) is required to select the menu and adjust the camera parameters.

3.1 VIDEO.OUT

You can set the frame rate as 25 fps/30fps.

3.2 DAY/NIGHT

Color, B/W, AUTO and EXT are selectable for DAY/NIGHT switches. Under the mode of the AUTO and EXT, you can set the IR LED as Smart and CDS. If the IR LED is selected as Smart, you can set the brightness of the IR LED.

DAY/NIGHT	
1. MODE	AUTO
2. D TO N	63
3. N TO D	63
4. DELAY TIME	20
5. RETURN	RET

Figure 3-2 DAY/NIGHT

SPECIAL	
1. PRIVACY ZONE	
2. MOTION	
3. HLC	
4. RETURN	RET

Figure 3-4 SPECIAL

3.3.3 AWB

Auto, User, Push, 8000k, 6000k, 4200k and 3000k are selectable for AWB. Under the mode of AUTO, you need to set the R-G/B-G Gain and to select an indoor/outdoor mode. If the AWB mode is select as User, you need to set the R/G/B Gain manually.

3.3.4 AE

You can set the AE mode as HOLD, DC and ESC.

Brightness: Brightness refers to the brightness of the image.

Shutter: Shutter denotes the speed of the shutter. You can set the shutter as AUTO, 1/25, 1/30, 1/50, 1/60, 1/100, 1/120, 1/250, 1/500, 1/1k, 1/3k and 1/10k.

Flicker: You can set the flicker status as 50HZ/60HZ to prevent image flicking.

BLC: BLC bases on the back area to enhance the brightness of the whole image. You can set the BLC gain from 0 to 16.

AGC: AGC optimizes the clarity of image in poor light scene. The value of AGC can be set from 1-5.

LSC: LSC corrects the phenomenon where the image gets darkened or blurred on the periphery.

AWB	
1. MODE	AUTO
2. R-G GAIN	255
3. B-G GAIN	151
4. RETURN	RET

Figure 3-3 AWB

3.3.5 SPECIAL

Privacy zone: Select a PRIVACY area. Set the MASK PAT as OFF, GRAY, WHITE or BLACK. Set the SX/EX/SY/EY value to define the position and size of the area.

Motion: Set the Motion status as ON or OFF. Set the SENSITIVITY from 0 to 255. Set the alarm status as ICON/TRANCE/OFF. Set the hold time from 0 second to 255 seconds.

HLC: HLC supplements the brightness of the peripheral area of the image. You can set the mask value and threshold from 0 to 255.

3.3.6 EFFECT

Color Gain: Color gain adjust this feature to change the saturation of the color. You can set the value from 0 to 255.

Color Hue: You can adjust the image HUE from 0 to 71.

Sharpness: Sharpness determines the amount of detail that an imaging system can reproduce. You can set the value from 0 to 255.

Contrast: Contrast enhances the difference in color and light between parts of an image. You can set the value from 0 to 255.

Bright Off.: Bright Off. refers to the brightness compensation of the image. You can set the bright compensation value as 0 or 1.

Mirror: You can set the Mirror status as ON/OFF.

Flip: You can set the FLIP status as ON/OFF.

EFFECT	
1. COLOR GAIN	200
2. COLOR HUE	200
3. SHARPNESS	25
4. CONTRAST	150
5. BRIGHT OFF.	1
6. MIRROR	ON
7. FLIP	ON
8. RETURN	RET

Figure 3-5 EFFECT

SYSTEM	
1. CAMERA ID	255
2. ID DISP.	ON
3. NAME DISP.	ON
4. LANGUAGE	ENG
5. FACTORY INIT	OFF
6. RETURN	RET

Figure 3-6 SYSTEM

3.3.7 SYSTEM

You can set the camera ID from 0 to 255.

Select the ID display and name display status as ON/OFF.

Chinese and English are selectable for the language of the menu.

You can restore the camera to the default by setting the factory initialization status as ON.

3.3.8 EXIT

Exit and Save & exit are selectable.