



Secu365



Cloud Based Smart Security Platform

Secu365 User Manual

| | |
|--|-----------|
| 1. Hardware | 2 |
| 1.1 Components of system hardware | 2 |
| 1.2 Control Center Edge Server | 3 |
| 1.3 OLED display message | 3 |
| 1.4 System Architecture | 4 |
| 1.5 Download Secu365 Mobile app or use network connection | 4 |
| 2. Edge Server connection and setting | 5 |
| 2.1 Starting Edge Server | 5 |
| 2.2 Log-in Web server | 5 |
| 2.3 Secu365 Dashboard | 8 |
| 2.4 Secu365 Settings | 20 |
| 3. Secu365 Mobile APP User Guide | 24 |
| 3.1 APP Account Register | 24 |
| 3.2 Start Use | 25 |
| 3.3 APP Interface | 27 |
| 3.4 APP system setup | 36 |

Secu365 User Manual

Secu365 is a system providing intelligent security management which focuses on residential applications and SME users. Based on the concept of HAAS (Hard as a server), and the integration of the cloud system, you are able to receive the security information anytime and any where.

• 1. Hardware

• 1.1 Components of system hardware

Central Controller (Edge Server)



Fingerprint
Smart Lock
(UL3 pro)



Fingerprint
Access
(C2 Slim)



Camera
(Easy View)



• 1.2 Control Center Edge Server

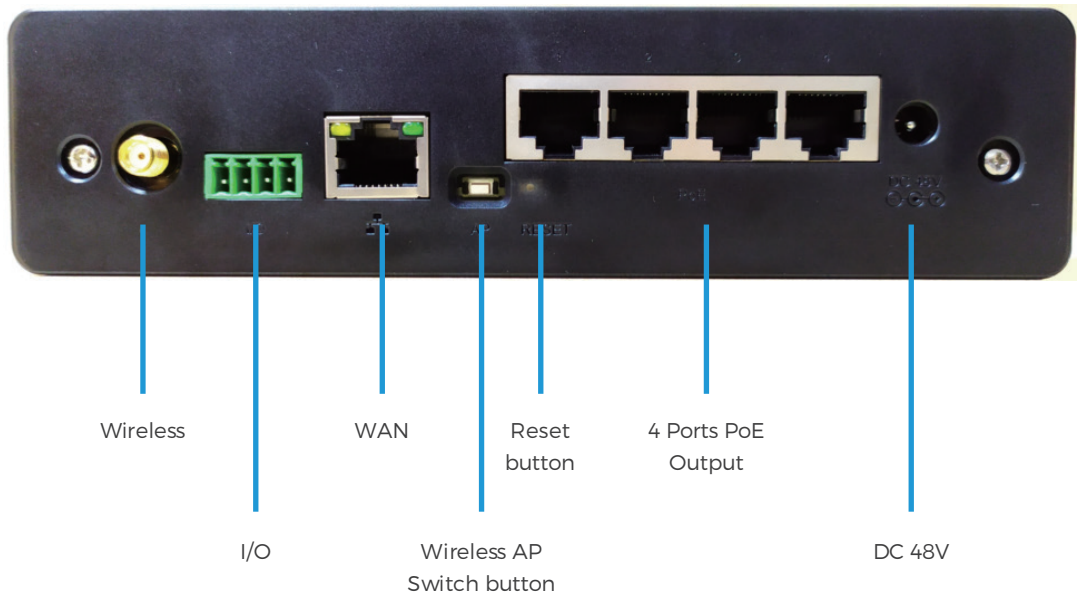

| | | | |
|---------|-------------------|---------|--|
| CPU | Dual-core 1.0G | COM | 1WAN and 4 PoE TCP/IP output |
| Storage | 4GB | | Support wireless AP switching |
| Memory | 1,000,000 records | Support | 4/8/16 CH access control and cctv camera input |
| Display | OLED display | I/O | 4 CH |

• 1.3 OLED display message

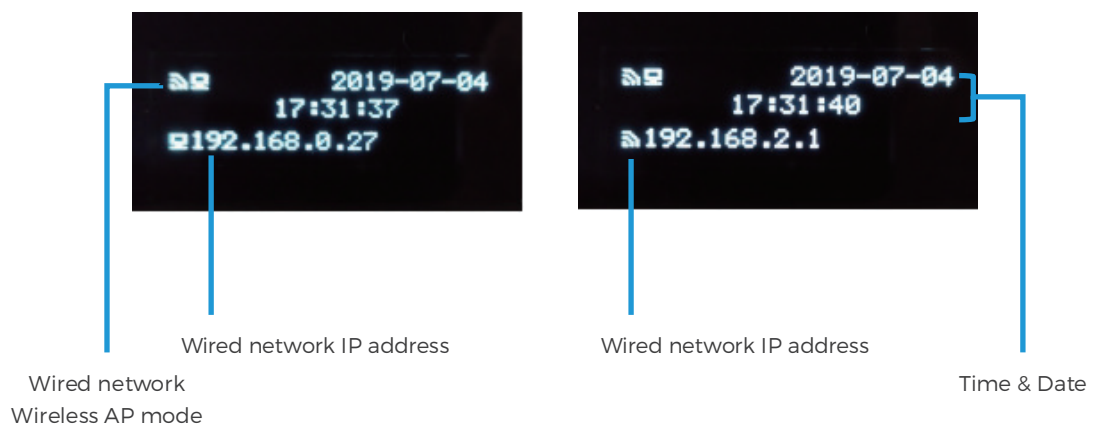

• 1.4 System Architecture



• 1.5 Download Secu365 Mobile app or use network connection



• 2. Edge Server connection and setting

• 2.1 Starting Edge Server

When you turn on the Edge Server at the first time, it will show the default setting of the Edge Server wireless AP function (Default SSID: Secu365), and the OLED display will show the IP address. User can log-in the web server to set up the system through Edge Server IP address or Edge Server Wireless.

Important:

Wireless AP SSID = "Secu365", it can be connected without verification code.

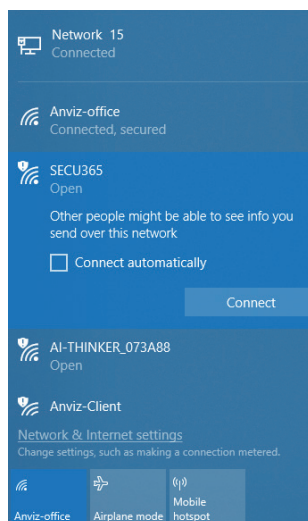
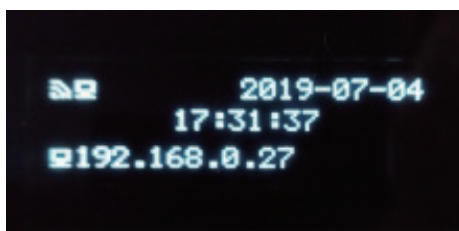

• 2.2 Log-in Web server

Open Browser in your computer, enter Edge Server IP address, Log in Edge Server Web server.



Please fill up the information when you log-in the server at the first time. Default account name: admin. Default password: admin. Click “Next Step” to enter the network setting page.



Edge Server IP address can be set according to the network actual circumstances, and make sure that it can be connected to the internet. (Contact the system manager for further questions), Then click next step.



System will detect Edge Server network connection automatically, make sure the system can connect the internet.



Starting the cloud service by scanning the QR code. (Refer to Secu APP instruction for details).



Caution:

- Secu Mobile app cannot be used for remote control if the cloud service is not started.
- After finishing the setting, Edge Server will close the WIFI AP function automatically. If re-start is required, please log-in to Edge Server Web server.

• 2.3 Secu 365 Dashboard

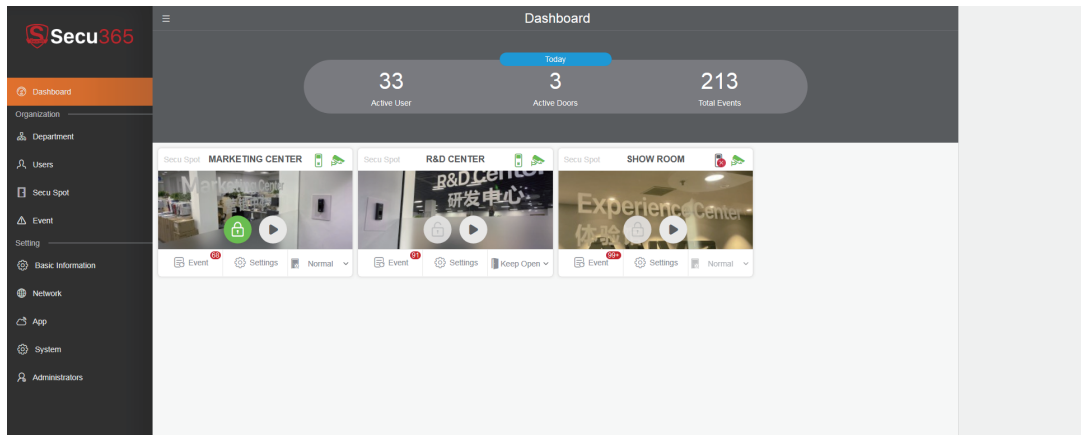

Secu365 dashboard shows key data of the system for including (Active User), (Active Spot), (Events), Edge Server IP address, SN number and firmware version.

• 2.3.1 Department

Includes department, user and Secu Spot management.

Department: Add department will create one sub department which displays all users' info.

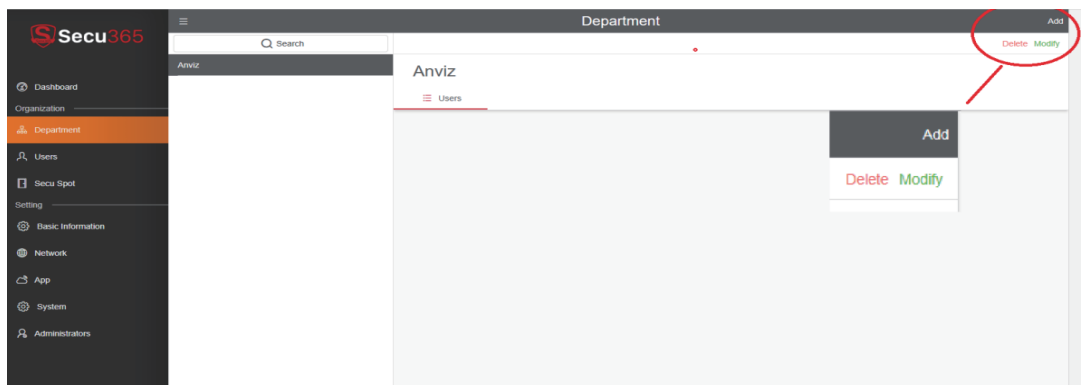

• 2.3.2 User

User Management:

including user info, identification enrollment, records and Secu Spot rights.

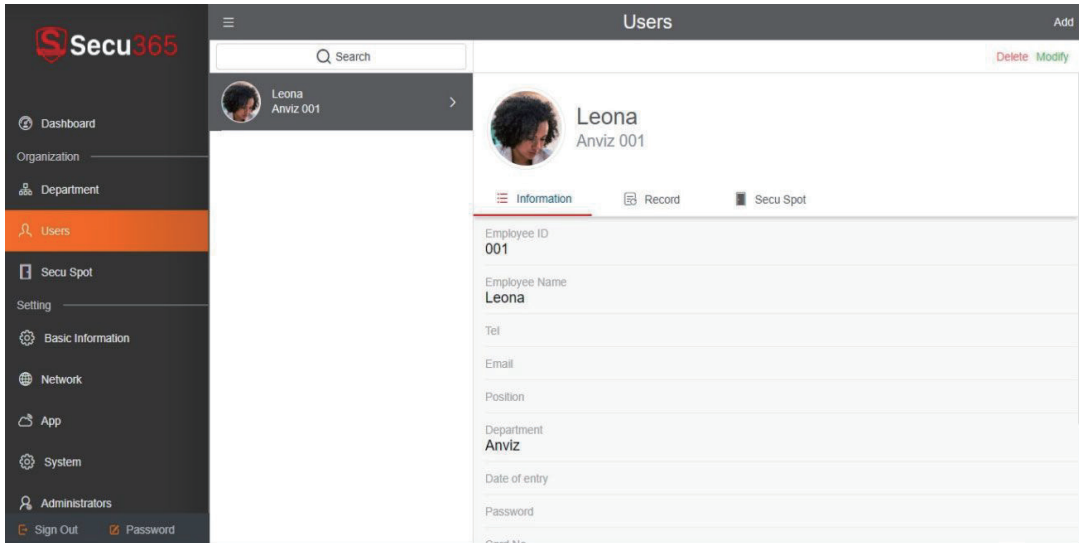

Click "Add" in the upper right hand corner, the personnel information editing page will pop up. Fill up the field highlighted in red. Click on the red icon to upload photos of the users with imaging size no more than 500K. The user image will be displayed in the records. Grant the user's access permission by adding authentication password and RFID card number.

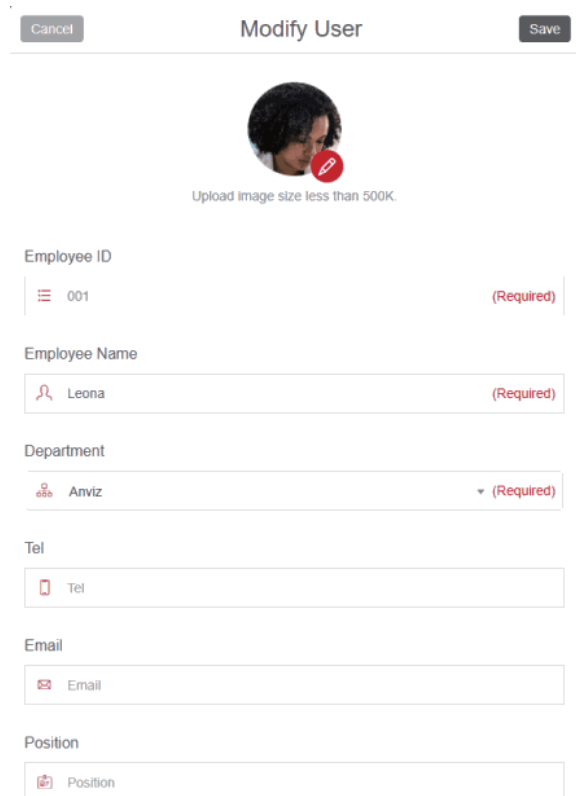
The 'Modify User' form is shown with a 'Cancel' button on the left and a 'Save' button on the right. It features a profile picture of the user with a red 'X' icon and the text 'Upload image size less than 500K.' Below this are several input fields: 'Employee ID' (001) with a red '(Required)' label; 'Employee Name' (Leona) with a red '(Required)' label; 'Department' (Anviz) with a red '(Required)' label; 'Tel' (empty); 'Email' (empty); and 'Position' (empty).

Click "Save" to complete the editing of user information. In the user management, you can access the records and access rights of users. (In the following chapters, the registration process of fingerprints, passwords and cards will be described.)

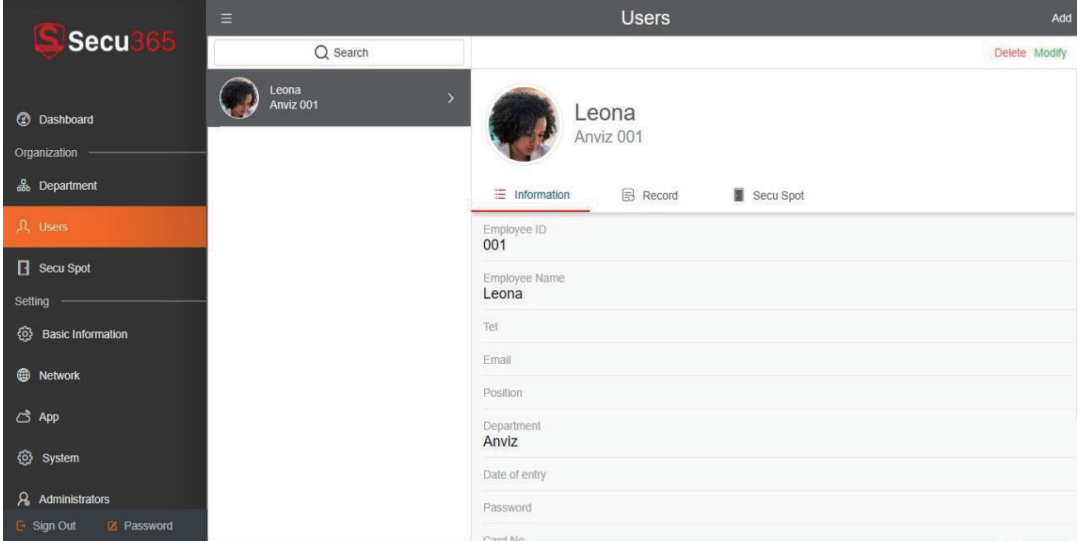

• 2.3.3 Secu Spot

Secu365 is a three-dimensional security solution, so the concept of security spot is enhanced. Security point integrates access control, video, alarm and other comprehensive applications.

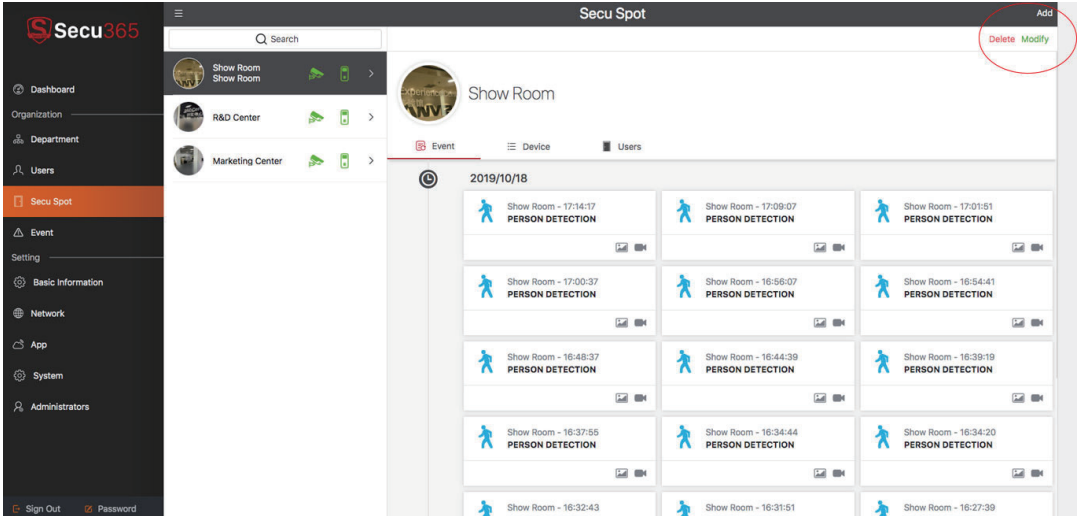

Click the “Add” button at the up right hand corner.

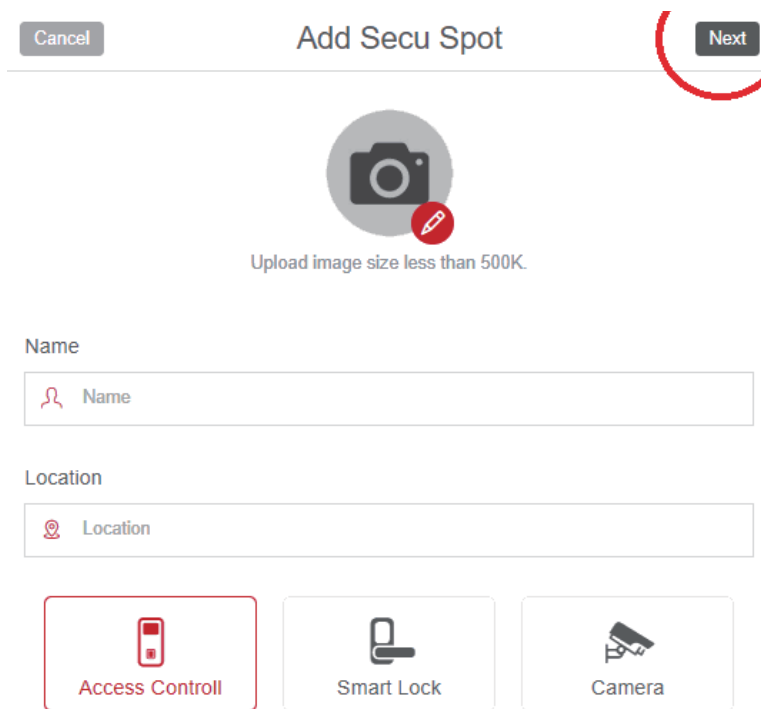

Cancel Add Secu Spot Next

Upload image size less than 500K.

Name

Location

Access Control Smart Lock Camera

Input the name and location, click the red icon, it can upload Secu Spot image, and this image will be displayed in the daily record.

Click “Next” to choose the device type integrated in.

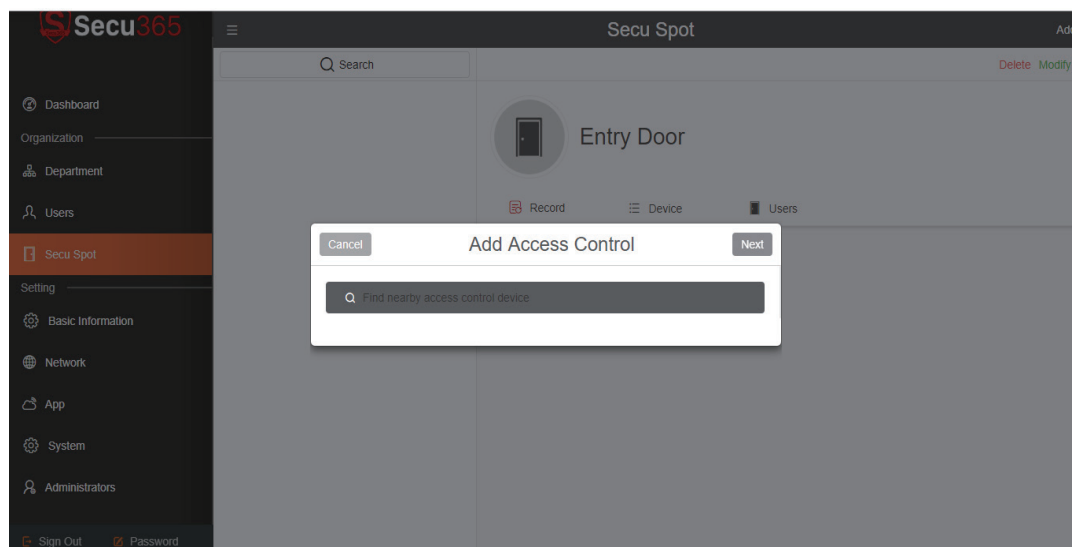

Click “Find nearby access control device” Edge Server will automatically search the physical access control device and display the list.

Suggestion:

For the first time installation, it is recommended to connect device's internet cable to edge server POE port to quickly add and configure the device.

CancelAdd Access ControlNext

🔍 Find nearby access control device



C2Slim
1560300119200107 / 192.168.17.43



C2Slim
1234567891234564 / 192.168.17.148

Choose the device in the list and click "Next" .

CancelAdd Access ControlNext

DHCP

IP Address

192.168.17.148

Netmask

255.255.255.0

Gateway

192.168.17.1

According to the actual network situation, configuring the network IP address of access control devices, it is suggested to set the same network segment as Secu365.

Click Next and the device will automatically be added to the system.

Go back to “Secu Spot” page after adding the physical access control device.

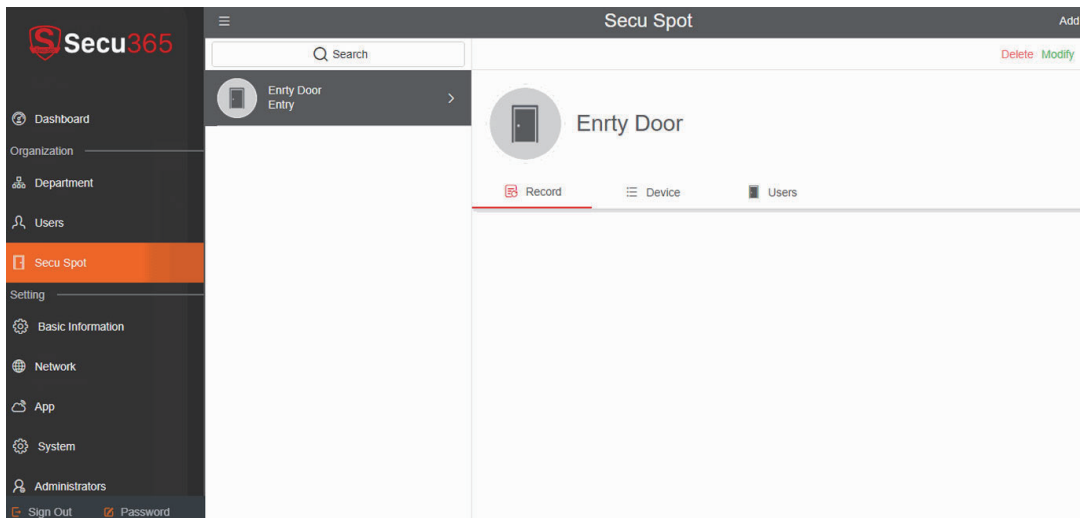

You can check the records and the events of the spot.

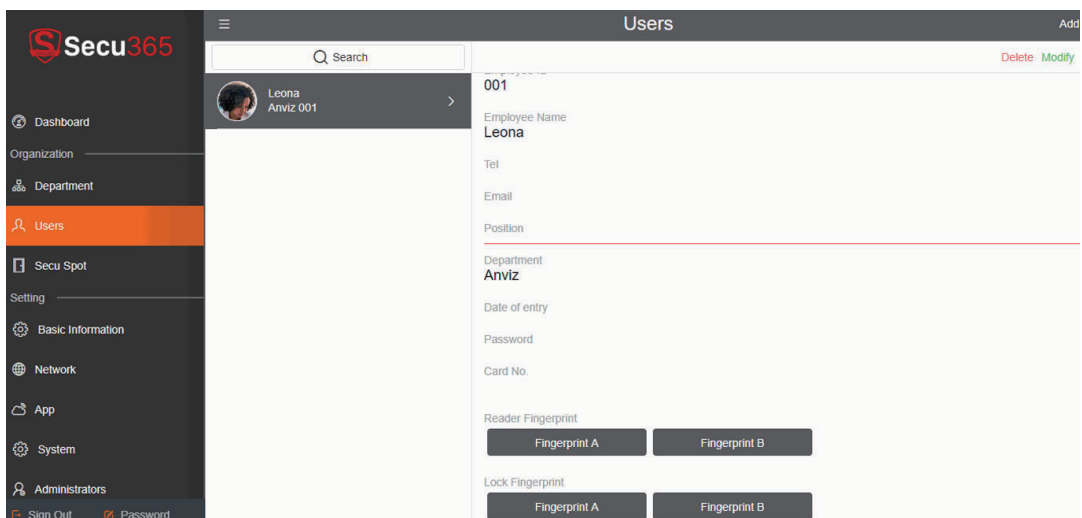

You can check and continue to add other devices.

Supported devices:

Video Camera: "Easy View" Camera.

Access Control Device: C2 Slim Fingerprint reader or UL3 pro Smart lock.

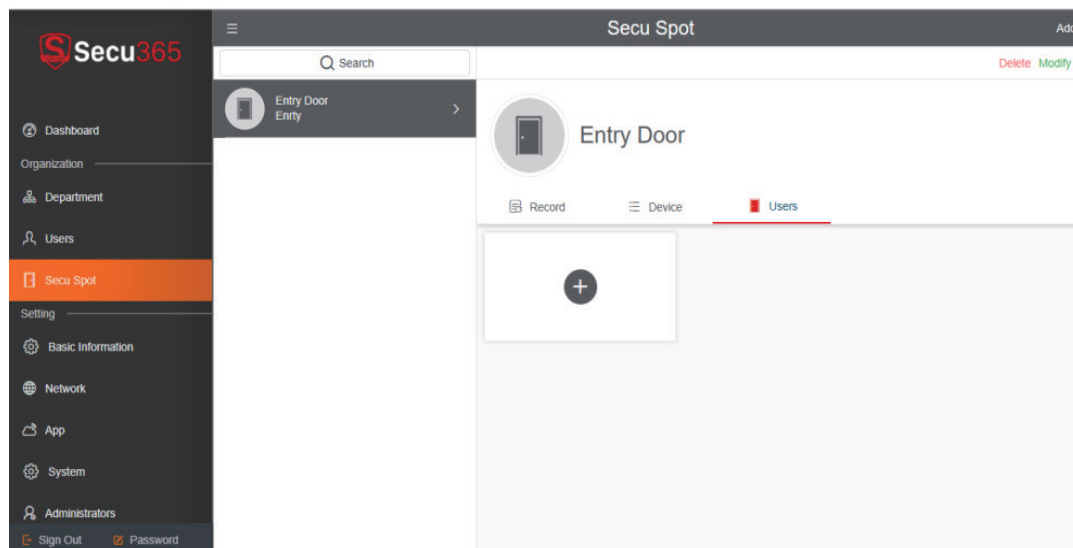

User under the spot point can be queried and added.

Important:

Smart Lock can only be added through mobile app.

Maximum support for a Secu Spot: 1 access control + 1 camera or 1 smart door lock + 1 Camera.

For adding additional camera, please refer to adding access control equipment.

• 2.3.4 User Fingerprint Registration

To complete the addition of Secu Spot and front-end devices (access control devices/cameras/smart locks), users should be assigned to the corresponding security points according to access control rights.

Please return to the user interface and select a user for fingerprint registration.

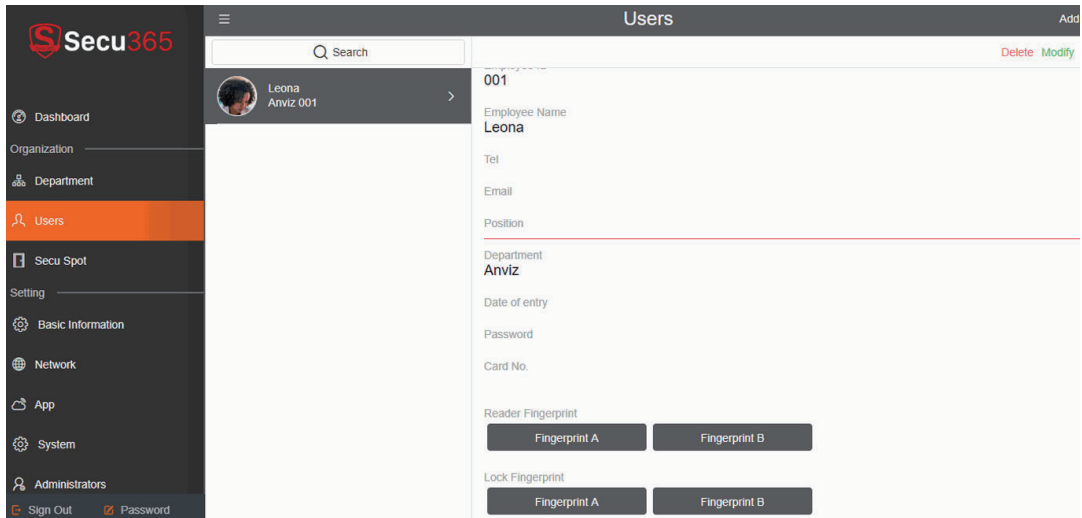

Important:

Because of the different types of fingerprint verification devices (fingerprint access control and smart lock), when fingerprint registration is selected with the device, one user can only register two fingerprints.

Click "Fingerprint A" to pop up the fingerprint registration dialog box, and select the fingerprint device for fingerprint registration through the device serial number. Click "Enroll" in the to start registering fingerprints on the device.



Important:

Fingerprint access control registration process:

The fingerprint device on the access control device is on and the blue LED indicator flashes.

2 Press the finger on the fingerprint sensor. According to the voice prompt of the device, press three times on the device until the device green LED indicator lights up, and fingerprint registration is completed.

Smart lock fingerprint registration process:

Waiting for the smart lock fingerprint device to light up till LED display screen displays "Register FP".

2. Press the same finger on the fingerprint sensor 6 times to complete fingerprint registration.

• 2.3.5 User rights to Secu Spot

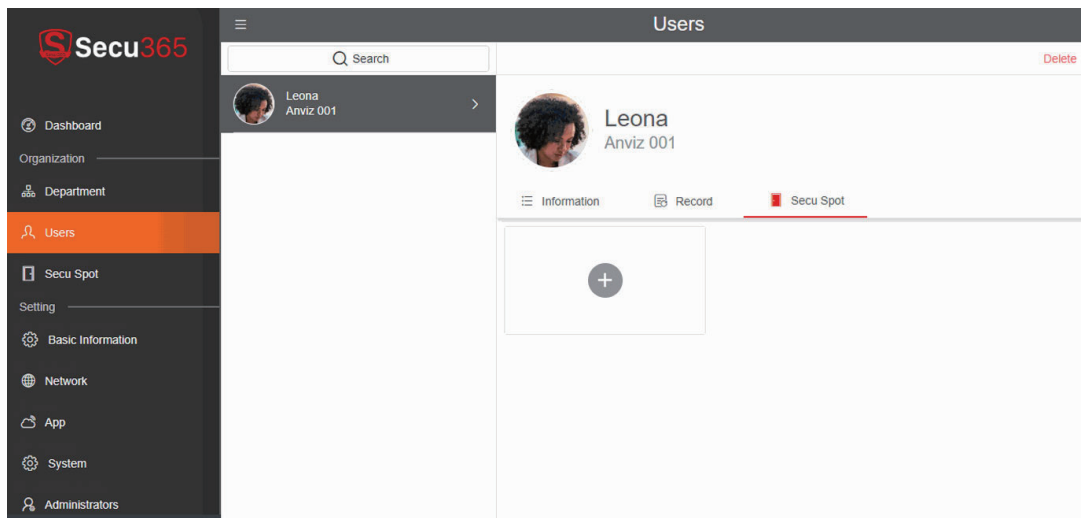

Complete the fingerprint registration and click "Cancel" to return to a single user's detail interface and enter the "Secu Spot" option.

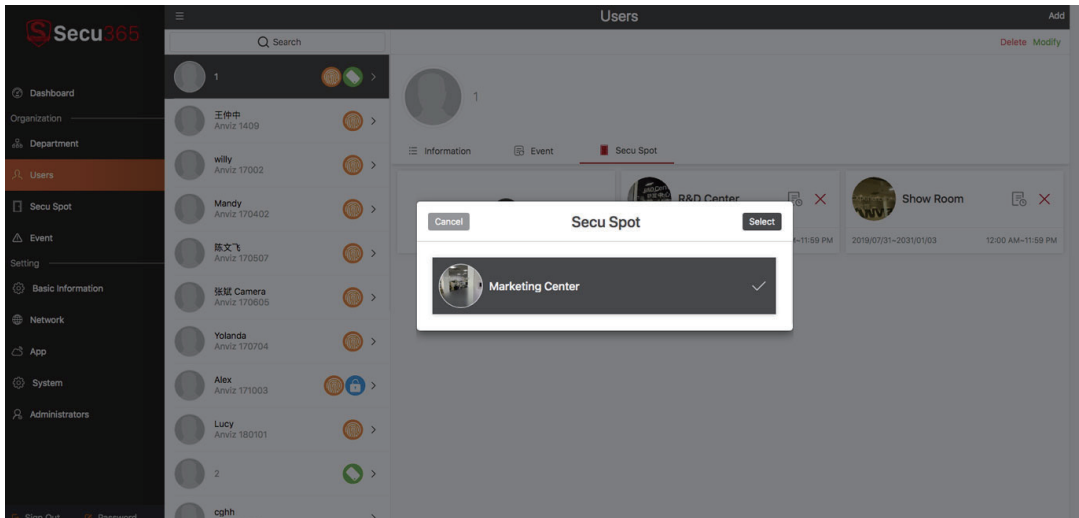

Click the Add button. Upload user to the specified Secu Spot device (optional Secu Spot).

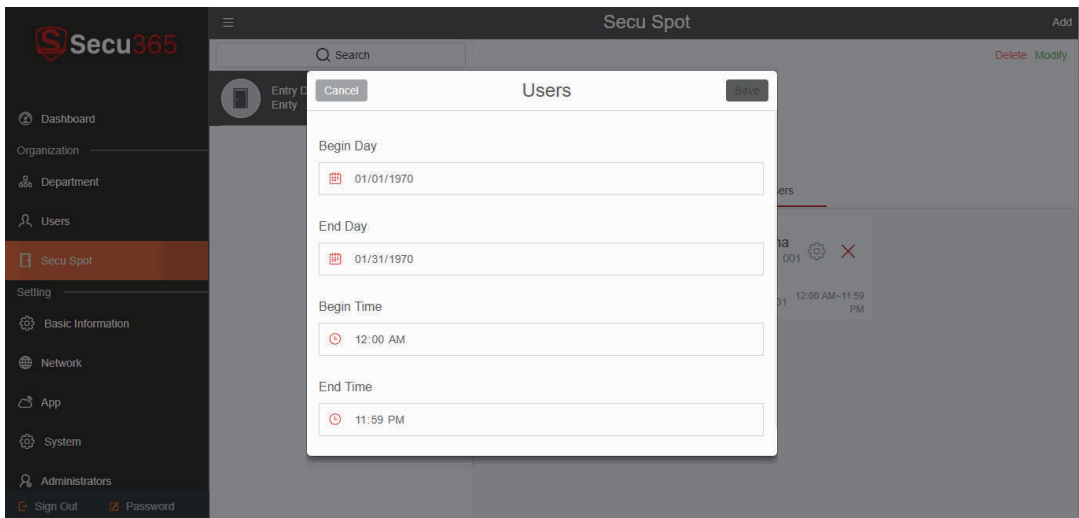

Click "Select" to set the user's time permission. Click "Select" again to save the time period settings of the designated user, and upload the user information and fingerprint information to the front-end device under the security point.

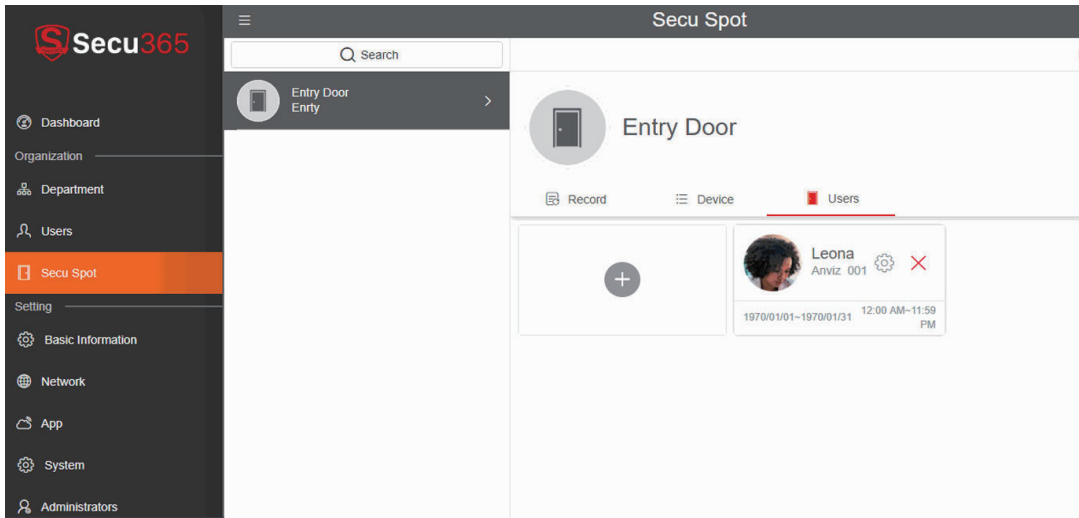

• 2.3.6 Batch users add to Secu Spot

When the "User" interface completes the collection and registration of authentication information such as fingerprint, password and card of all the users, batch user rights can be added to the Secu Spot under the "User" option in the "Secu Spot" setting interface.

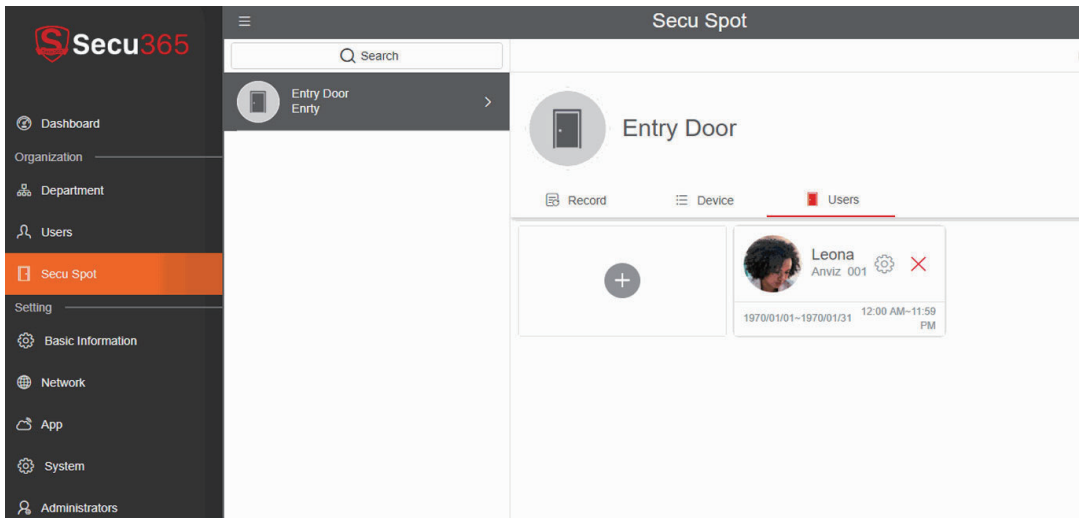

Click "Add" Button

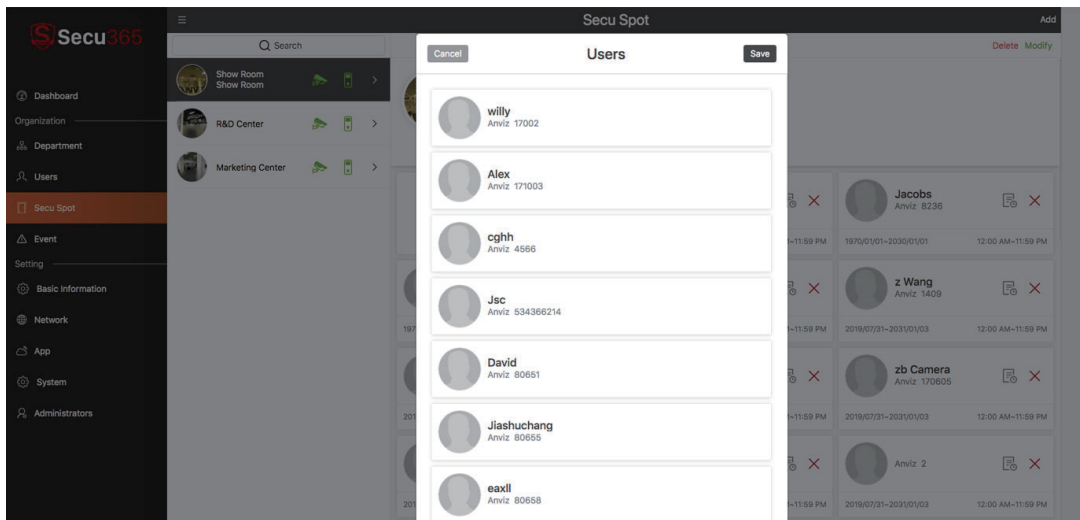

Available in the user list. Select users, add users in batches and click "Save".

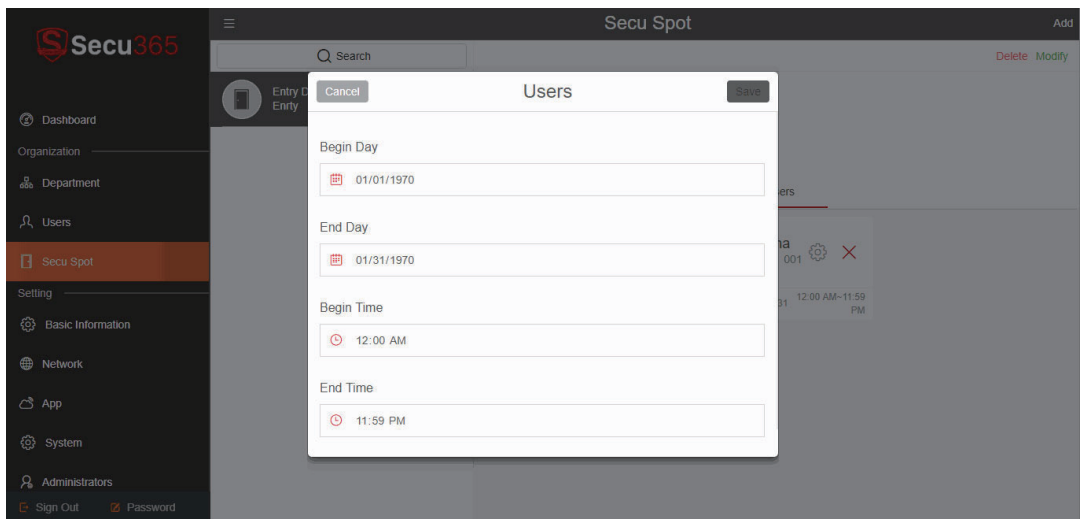

For the selected user, you can set an user's time privilege setting, click "Save" to complete the access control settings on the Secu Spot, and upload batch user and fingerprint information to the fingerprint device on the Secu Spot.

• 2.4 Secu365 Settings

Secu365 setting includes the setup of basic information, network, app, system and administrators.

• 2.4.1 Basic Information

The screenshot shows the 'Basic Information' settings page in the Secu365 interface. On the left is a navigation menu with options like Dashboard, Organization, Department, Users, Secu Spot, Setting (selected), Basic Information (highlighted), Network, App, System, and Administrators. At the bottom of the menu are 'Sign Out' and 'Password' options. The main content area is titled 'Basic Information' and contains three sections:

- Company:** A 'Company Name' field containing 'Secu365 Demo' and a 'Save' button.
- Date & Time:** A checked checkbox for 'Auto sync time from internet', a 'Timezone' dropdown menu set to '(GMT+08:00) Shanghai', and a 'Save' button.
- Language:** A dropdown menu set to 'English' and a 'Save' button.

Basic information: company name setting,
Date and time setting: the edge server automatically synchronize time with cloud according to local time zone. You can also manually setup the time and date.
System language: Chinese/English

This is a close-up of the 'Date & Time' settings section. It features a 'Save' button in the top right corner. Below it is a checked checkbox labeled 'Auto sync time from internet'. Underneath is a 'Timezone' dropdown menu currently set to '(GMT+08:00) Shanghai'.

This is another close-up of the 'Date & Time' settings section, but with the 'Auto sync time from internet' checkbox unchecked. It includes a 'Save' button in the top right corner. Below the checkbox is the 'Timezone' dropdown menu set to '(GMT+08:00) Shanghai'. At the bottom, there are two input fields: 'Date' with the value '08/19/2019' and 'Time' with the value '10:50 AM'.

• 2.4.2 Network Setting

Secu365 setting includes the setup of basic information, network, app, system and administrators.

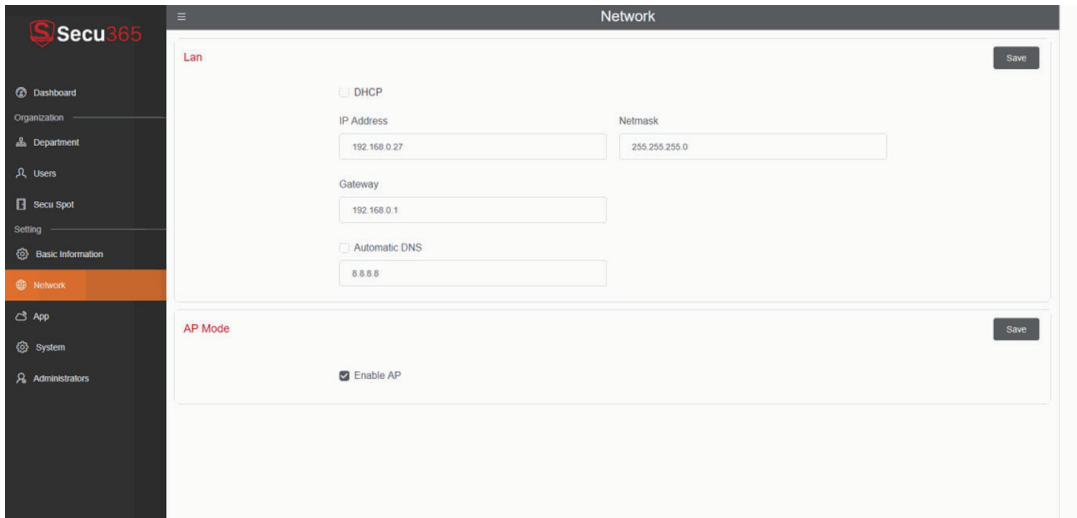

Secu365 supports DHCP IP configuration, manual IP configuration and it also supports WiFi AP mode.
LAN: Input effect IP address, ensure Edge Server connect to internet.

Testing: After setting up the network, click "Testing" , it will automatic check the network settings.

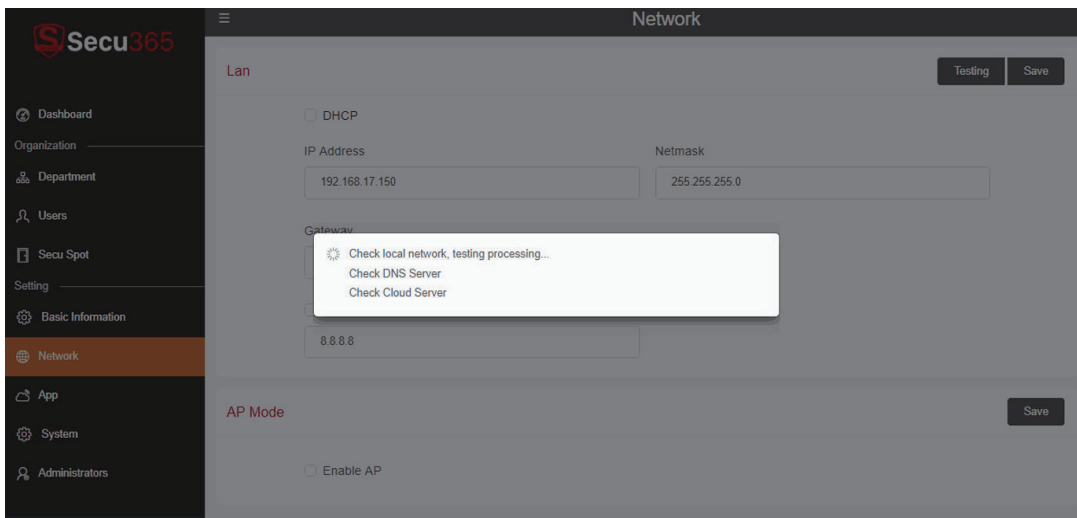

AP Mode: The wireless AP function is only used to set up links in Edge Server's web server. The AP mode automatically shuts down in 10 minutes with no data activities.

• 2.4.3 APP Settings

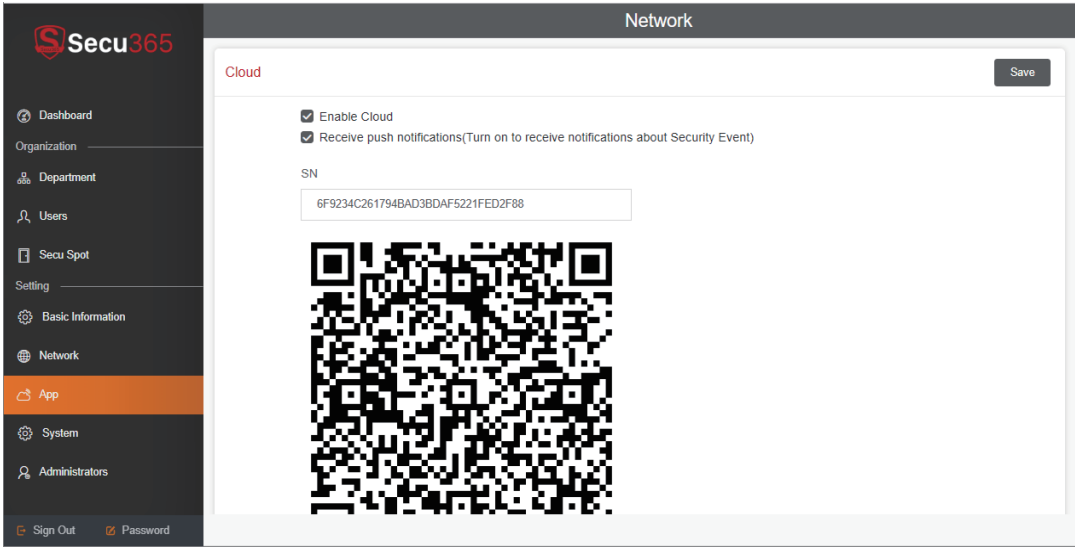

Edge Server needs to be managed through mobile app. Edge Server cloud links must be enabled. Click “enable cloud”, scan the 2-D code for Secu365 cloud links. Add the Edge Server device to mobile app.

• 2.4.4 System Settings

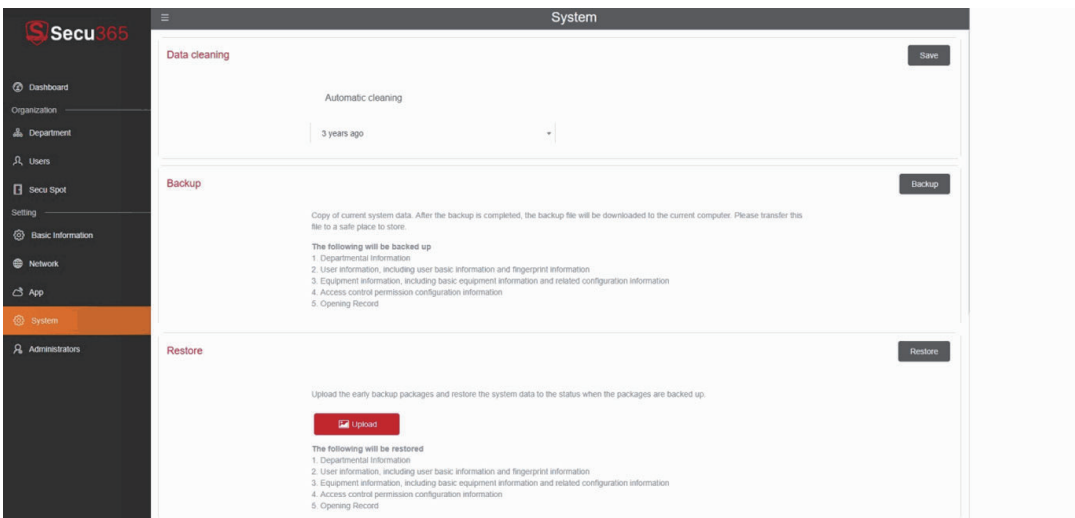

System configuration includes: data cleaning, data backup, data restore, system reset, system initialization and online upgrade functions.

Data Cleaning: Edge Server can store up to 1 million records and 3,000 video messages (excluding the photo information) and automatically delete previous records according to the selected length of time.

Data backup: The system will generate a data backup file in .bak format, which will be saved by users.

Data Restore: The backup data restore can be used for hardware replacement.

Initialization:

Clear all data: Clear the entrance guard records, personnel and other data in the system. But, it will not clear the hardware equipment settings and network information.

Reset factory: Equipment is restored to factory default settings.

Reboot: Restart Edge Server Web Server.

Online Upgrade: Update the device firmware.

• 2.4.5 Administrator Settings

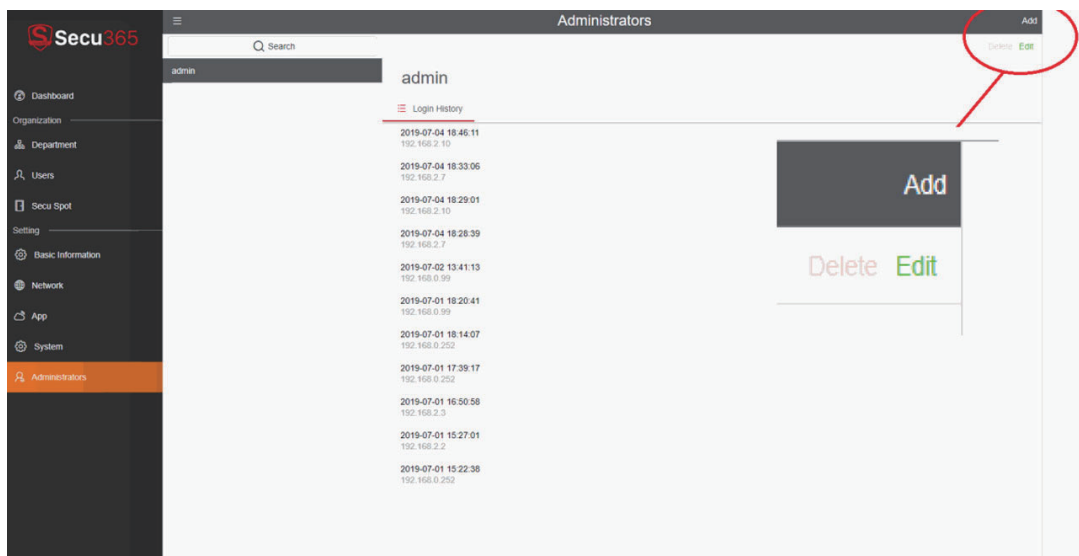

Administrator Setup Interface displays the Administrator's Operational Log Information.

Editing: Editing and modifying administrator account passwords;

Delete: Delete the selected administrator account;

Add: Add the administrator to the Edge Server system.

• 3. Secu365 Mobile APP User Guide

Download Secu365 Mobile APP by scanning the 2-d bar code, install and register an account.

• 3.1 APP Account Register

Open the APP, click “REGISTER” to start registering an account.

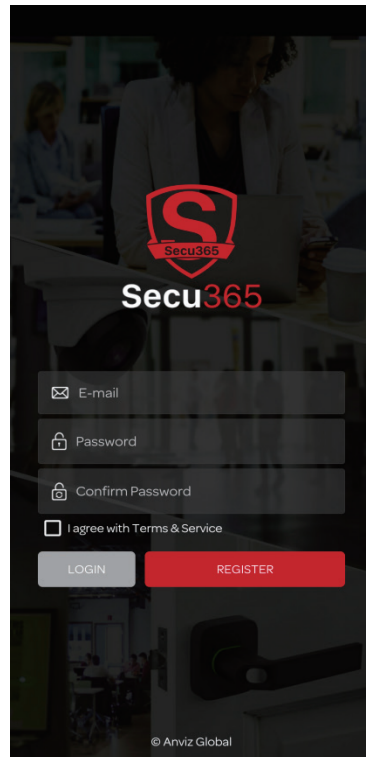
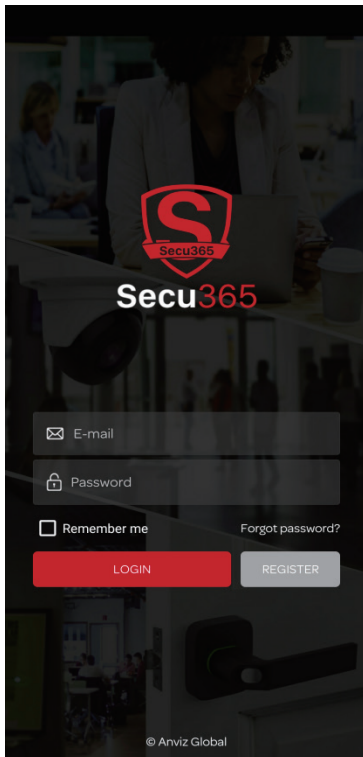

Secu365 account is registered by email ID, enter email ID and password, and agree to service term.

Important:

The email of the registered account is the only email for resetting password.

Registered password format

1. Password is 6 to 16 digits.
2. Use the combination of letters, numbers and symbols.
3. Avoid using the following password format. The system will remind you to modify the password if it does not meet the security requirements:

- (1) The password is the same as the member's name or E-mail address.
- (2) All letters.
- (3) All number.

After the successful registration, enter your account ID and password to login to APP.

• 3.2 Start Use

Add Edge Server to APP for the first time use, click + button

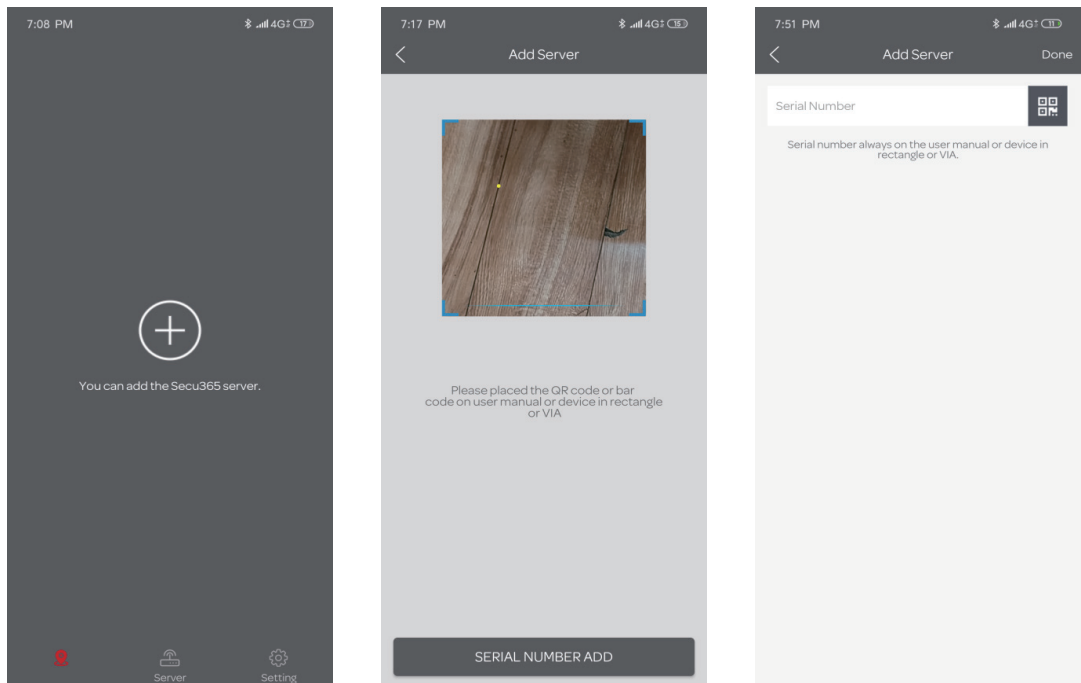

Scan the two-dimensional code on the Edge Server or under the Edge Server Web Server-APP page. Or enter Edge Server serial number manually for manual additions. Click on the "Done" button to proceed to the next step.

Important:

Edge Server and mobile APP must be linked to the cloud in order to be managed properly. Therefore, by default, mobile APP is required to complete the management of Edge Server smoothly by linking to Edge Server's own wireless AP and landing in Edge Server's web server for cloud configuration.

For the first time using Edge Server and APP bindings, you need to link Edge Server wireless AP by mobile phone, open Edge Server wireless AP function through the picture prompt of APP, and the WiFi of mobile phone links to the wireless AP.

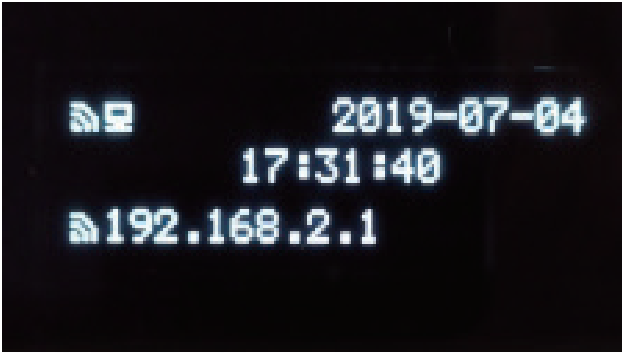

Edge Server show WiFi AP open

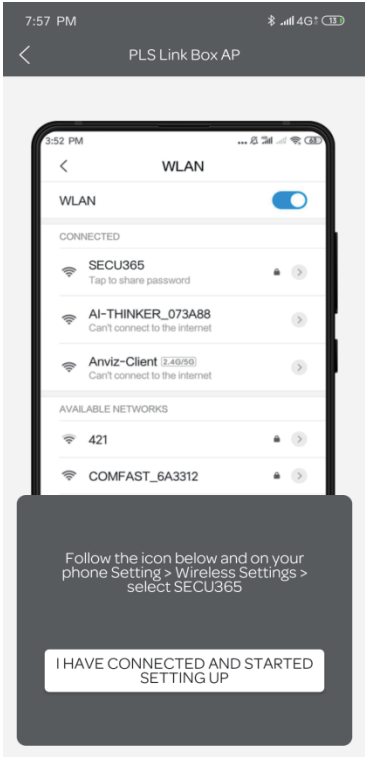
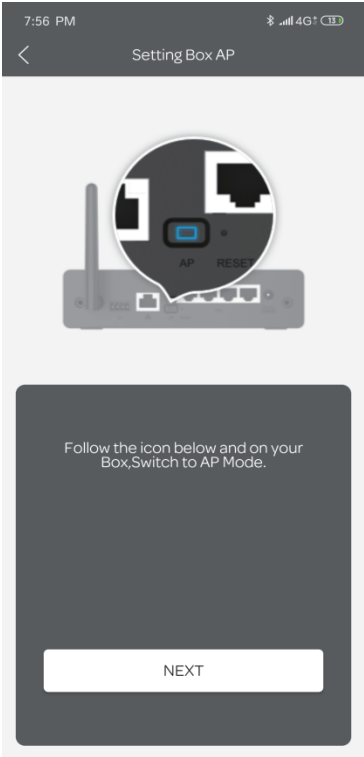

Important:

Edge Server's wireless AP SSID is : SECU365

Wireless AP can be directly connected without a password. AP will shut down automatically in 10 minutes with no data activities.

To link the Mobile APP to the wireless Edge Server, click "I HAVE CONNECTED AND STARTED SETTING UP", It will automatically connect to Edge Server's built-in Web server. **According to the prompt operation boot completed, Edge Server system settings. Refer to "2.2 Login Webserver" for details. (original Chinese version needed)**

When finishing the setup of APP, it will lead to the main interface of mobile phone.

• 3.3 APP Interface

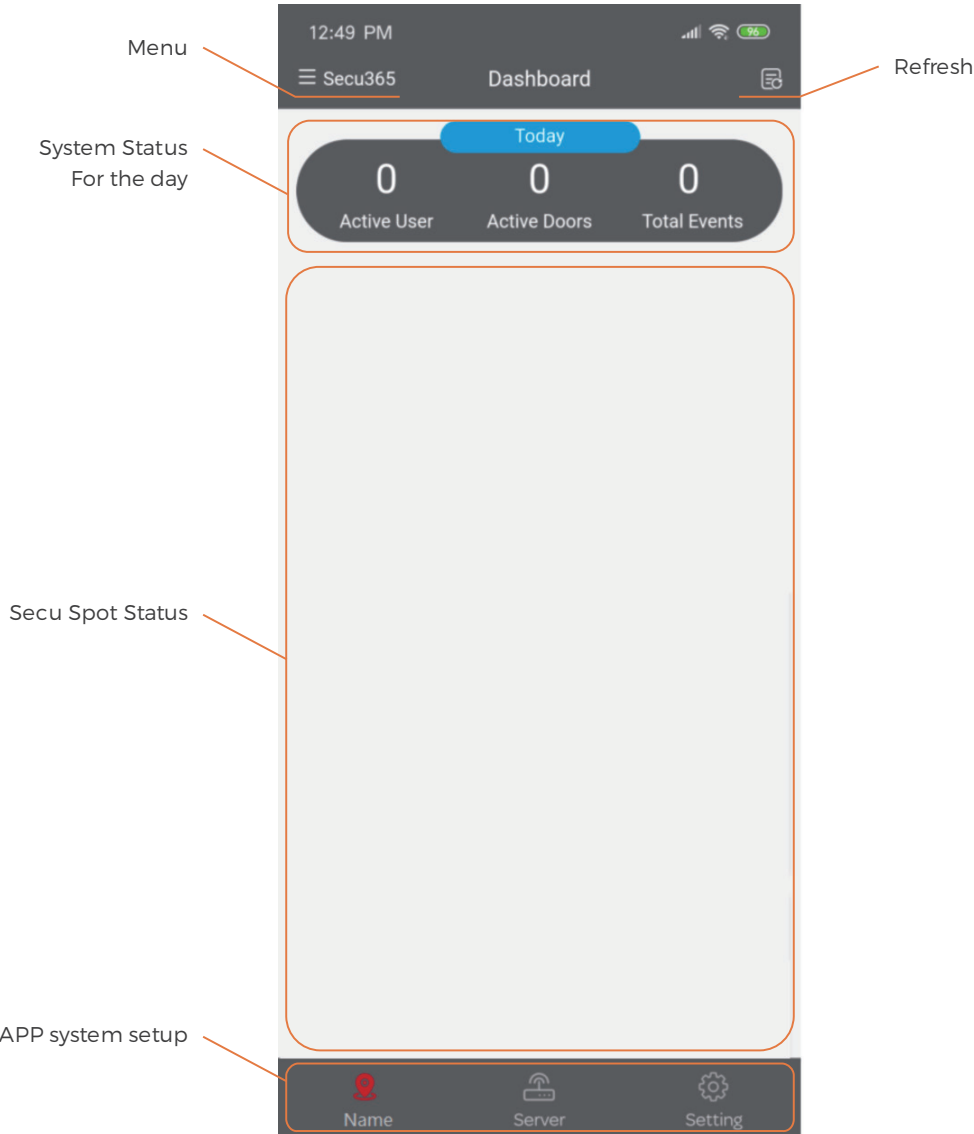

Menu: Click on the menu to display the current Edge Server Operations Management Menu.
Active User, Active Spot and Events in the System.
Secu Spot status bar: Secu Spot status will be displayed here shortly after successful setup.

APP System Settings

Name: Current Edge Server System Status.
Server: Under current APP account, Edge Server device list, or add Edge Server.
Setting: APP Account Management.

• 3.3.1 APP Menu

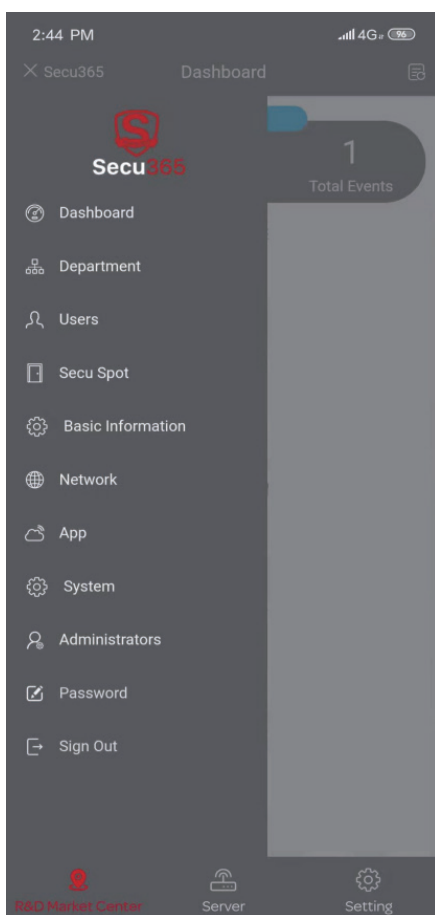

APP menu is the same as Edge Server Web server, refer to 2.3~2.4 for the details.

• 3.3.2 Secu Spot Status

The complete status of Secu Spot will be displayed:

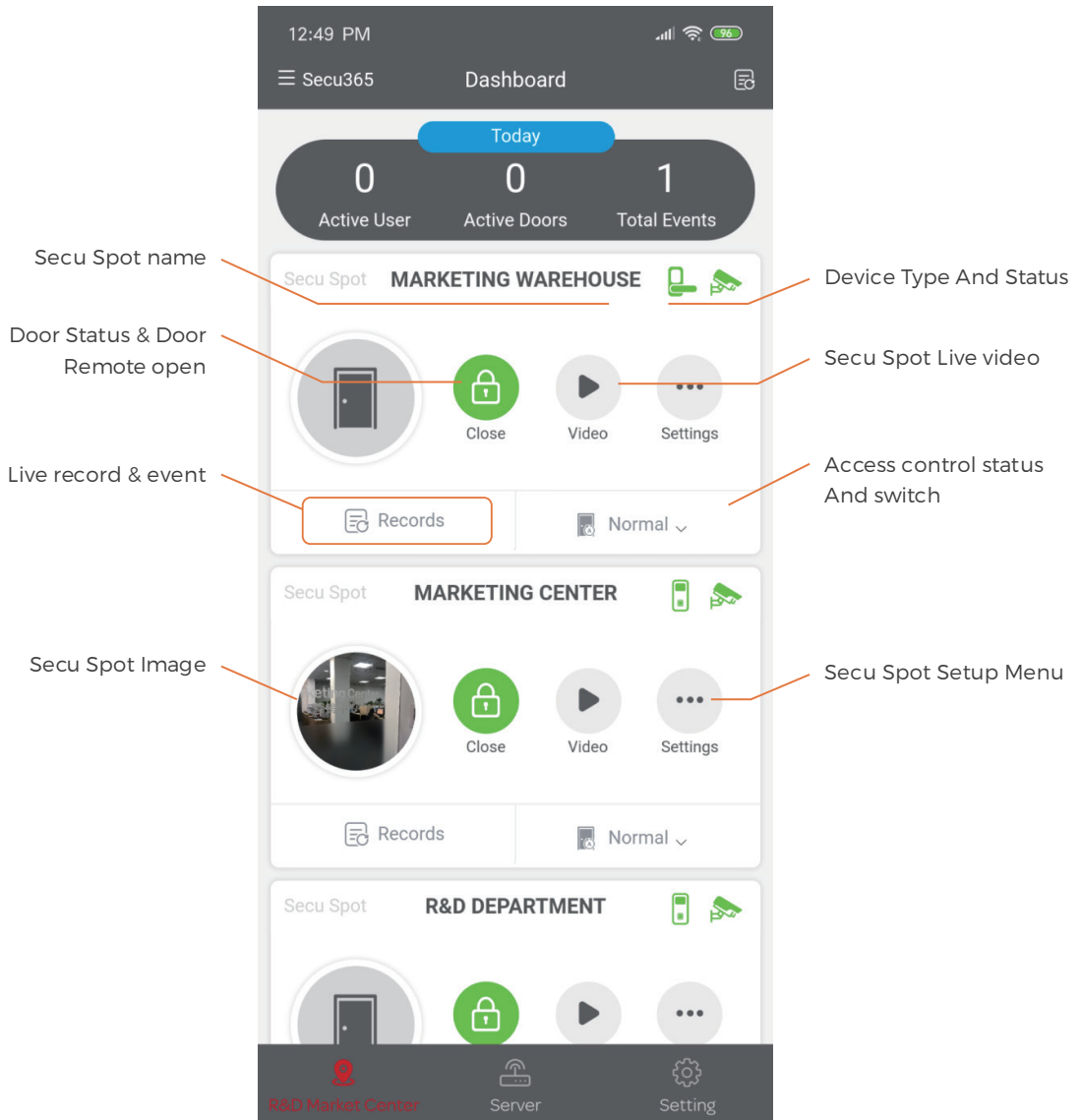

Name of Secu Spot: When adding Secu Spot, you can customize the name of Secu Spot. You can use Secu Spot photos as background pictures.

Models and status of equipment:

 Access Control Device  Smart Lock Device  Camera

 The green icon represents the device's online status.

 The red icon indicates that the device is offline.

Door Status and Remote open:

 Door opened  Door closed. Click  icon to remote open the door

Live Video

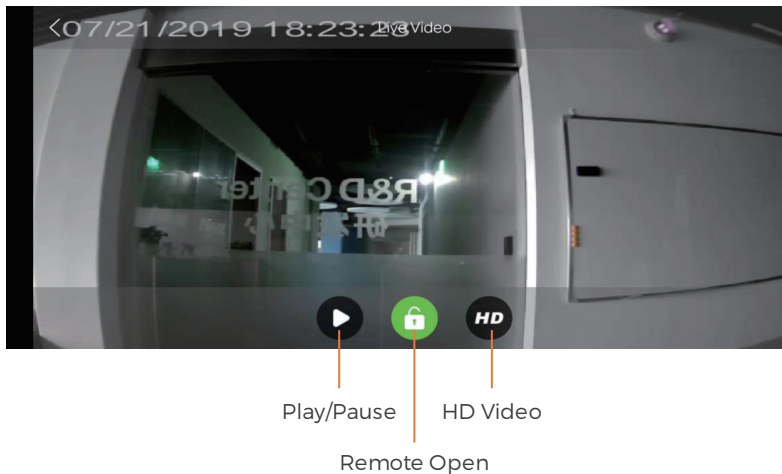

Real-time record: Click on the real-time record to view the user record of the day at the Secu Spot. You can click on the snapshot of the user picture and the short video of the user operation (12-15 seconds).

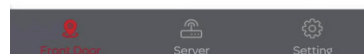
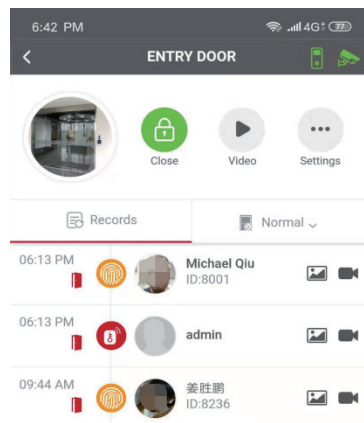

Door Status Switch: Normal/Keep Open /Keep close status.

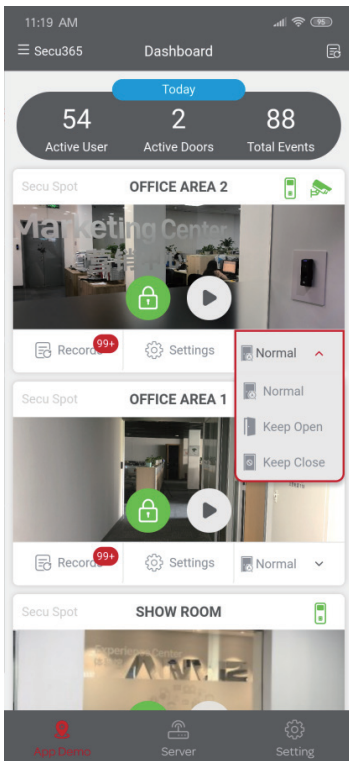

Secu Spot Setup: Click Setup Button to Secu Spot Setup page.

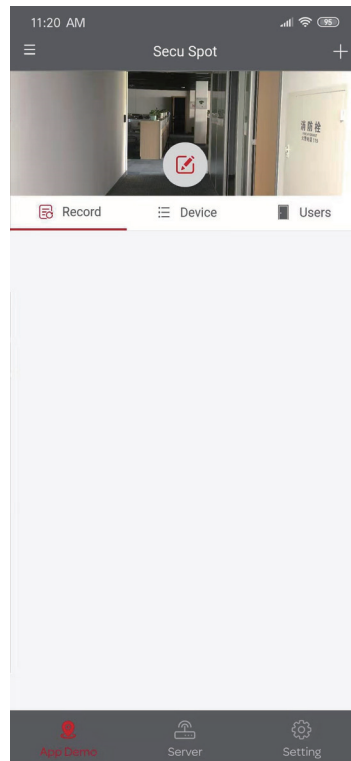

• 3.3.3 Add Smart Lock

Because the smart lock has no network communication function, the Wifi bridge is used to connect the smart lock via the Bluetooth and connect to the network via the Wifi.

Suggestions and Notes:

Please ensure a good Internet wireless network environment.

Please plug the Wifi bridge into the power outlet.

Smart Lock Installation (4XAA) Battery.

Please turn on the Bluetooth on mobile phone.

For a quick setup, keep the Wifi bridge, Smart Lock and Mobile Device within 10FT.

Under Secu Spot - Device, select Smart Lock and click "+"

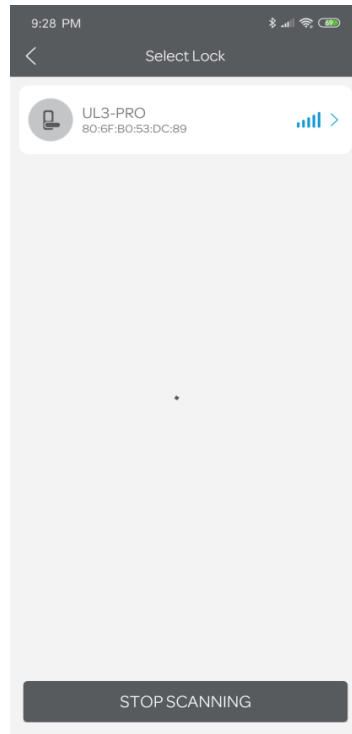
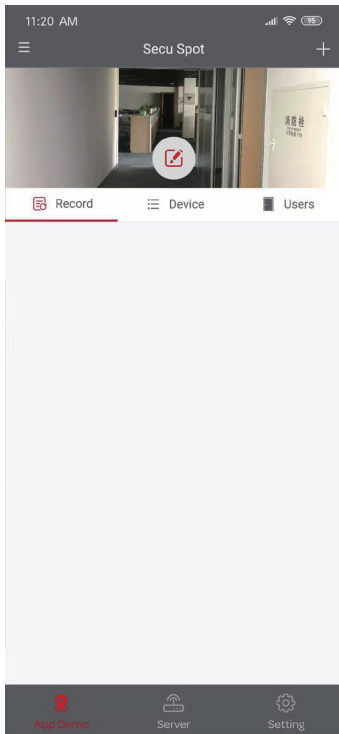

System will remind you to turn on Bluetooth on mobile phone. Through Bluetooth, Smart Lock is searched, selected. And automatic go to next step.

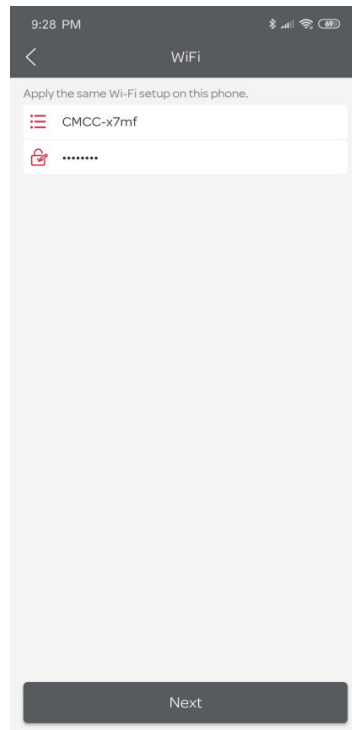
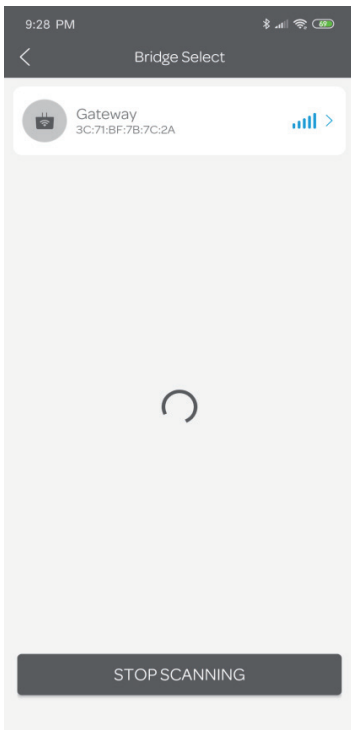

Search the Gate Way and choose next step。 Setup the Gate Way WiFi connection.

APP will input the connected WIFI SSID directly and input the password. Click next step and wait for the smart lock connection.

• 3.3.4 Add user

Choose add “User” in the APP menu.

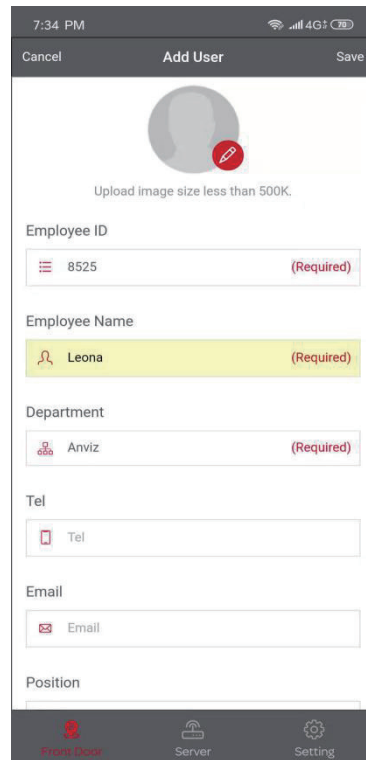

Click “+” on the up right hand corner, input the user info, click “Save”, back to “User” page。

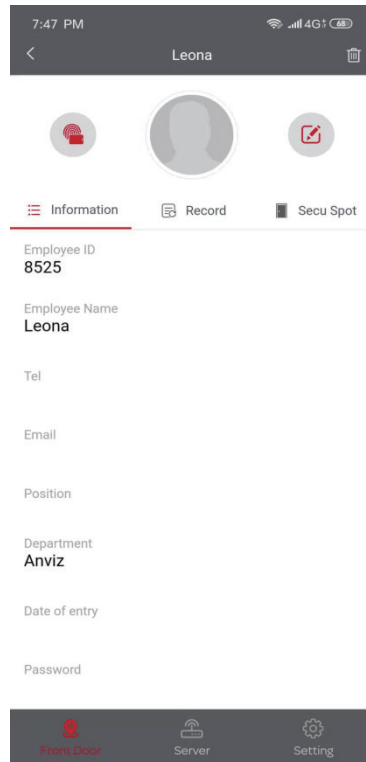

Select again to add more users, click  icon to enroll the user.

input (0~6 digit user id) and the card number, choose the device to enroll.

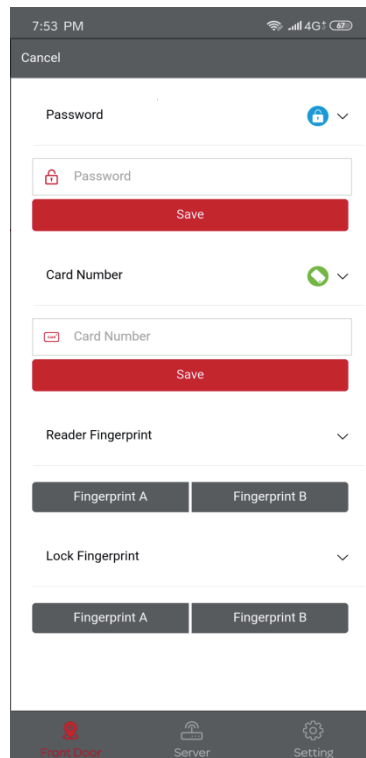

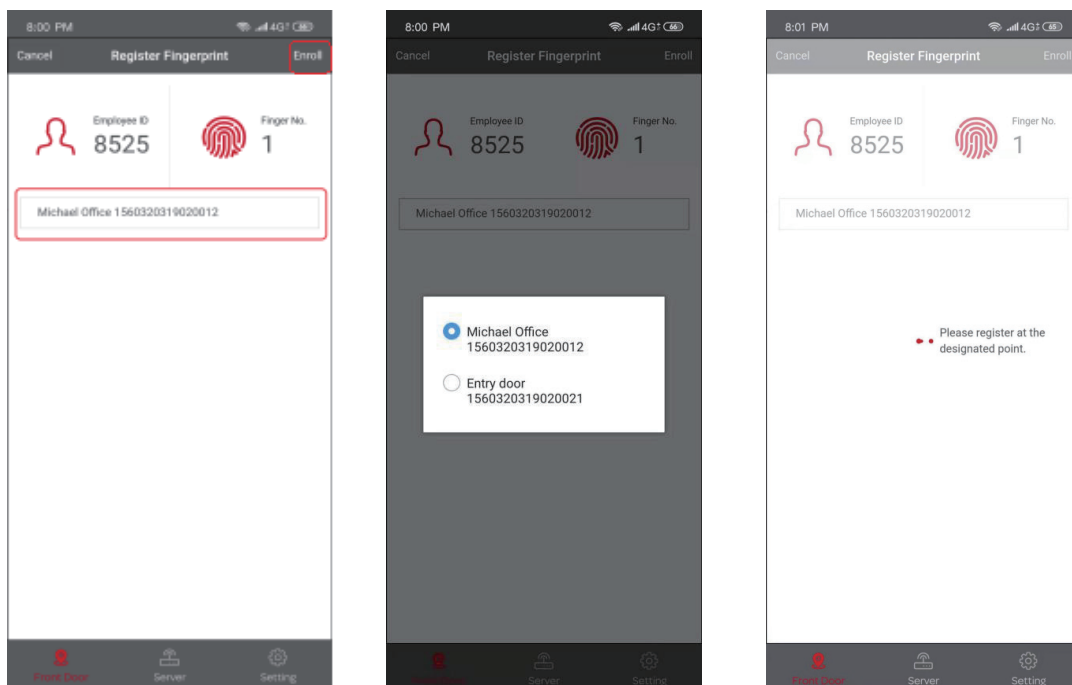

Click the device selection box, select the user's nearest fingerprint registration device, and click the “Enroll” button in the upper right hand corner to perform the fingerprint registration process.

Important:

Due to the different type of fingerprint authentication devices (fingerprint access control and smart lock), fingerprint registration is selected according to the actual fingerprint verification device type. Each user can only register 2 fingerprints.

Access control device fingerprint registration process:

- 1 The fingerprint device lights up on the access control device, and the blue LED indicator flashes;
- 2 Following the device voice prompt, press the same finger on the fingerprint sensor. You need to press it three times on the device until the device green LED indicator lights up to complete the fingerprint registration.

Smart lock fingerprint registration process:

- 1 Tap on the smart lock electronic panel and the LED displays "Register FP";
- 2 Following the display prompt of number 1 to 6, press the same finger on the fingerprint sensor 6 times to complete the fingerprint registration.

- 3.4 APP system setup
- 3.4.1 Server

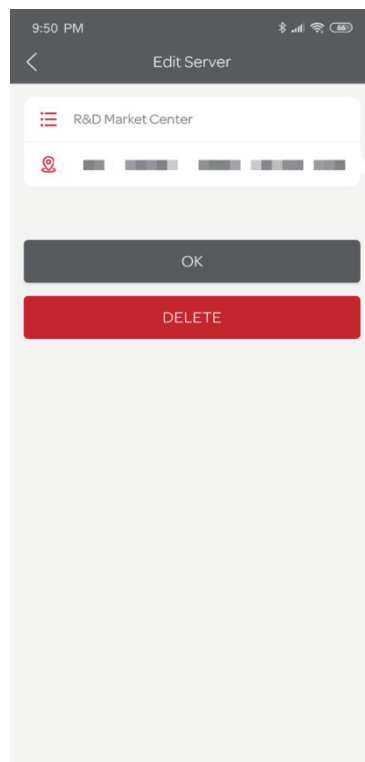
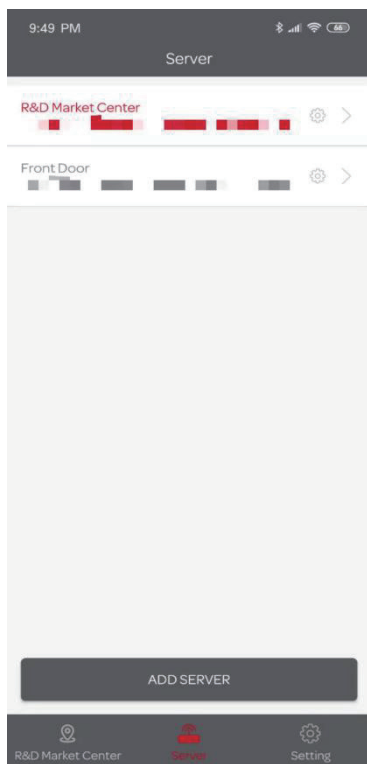

From the list all the Edge Server information and choose the one to setup the detailed information.

Click  icon to modify Edge Server name, click “DELETE” to delete Edge Server in App management.

• 3.4.2 APP Account Management

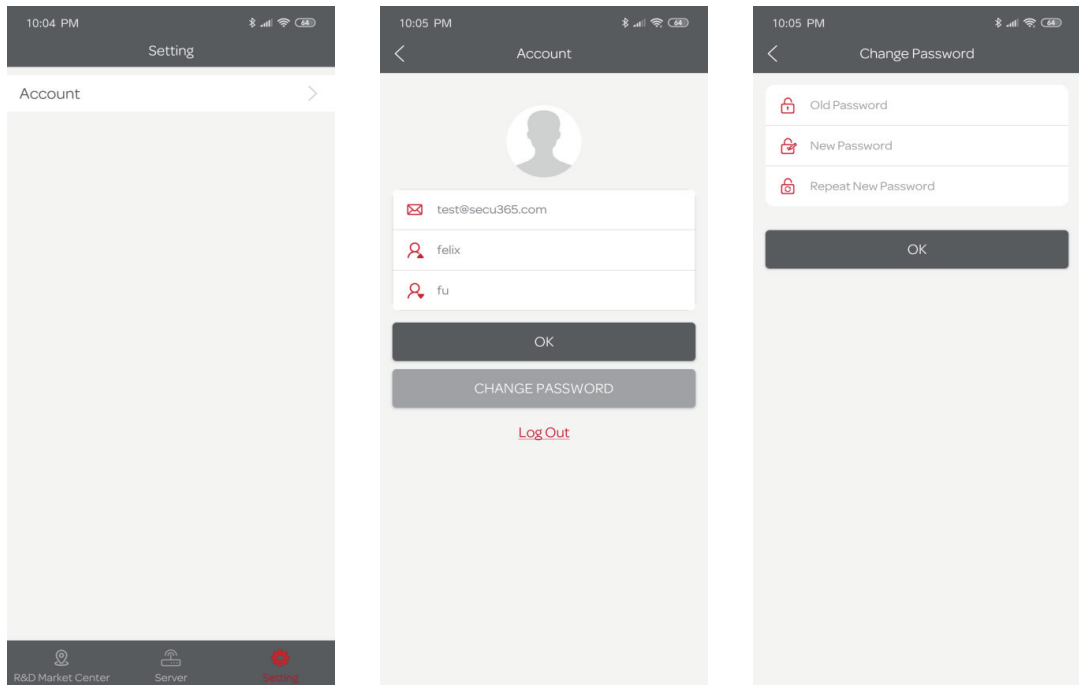

Click “Setting” to choose “Account” to manage APP and APP, you can name the account and edit the password.



Secu365

Inspiring Everyday

@2019 Anviz Global Inc. All right reserved

Due to the consistant improving of the product, this specifications and appearance can be modified without notice.

Fot the most up-to-date information, pls visitit www.secu365.com