



Nothing but **HEAVY DUTY.**

HAND TOOLS AND STORAGE FALL 2019



**ULTIMATE PRODUCTIVITY.
SUPERIOR PERFORMANCE.**

STUD™ TAPE MEASURES

INDUSTRY'S MOST DURABLE TAPE MEASURE

14' STANDOUT



Rip & Wear Resistant Blade

Model #	Description
48-22-9716	16ft STUD™ Tape Measure
48-22-9725	25ft STUD™ Tape Measure
48-22-9735	35ft STUD™ Tape Measure

Model #	Description
48-22-9717	5m/16ft STUD™ Tape Measure
48-22-9726	8m/26ft STUD™ Tape Measure
48-22-9725M	25ft STUD™ Magnetic Tape Measure

WIDE BLADE TAPE MEASURES

LONGEST STRAIGHTEST STANDOUT

14' STANDOUT

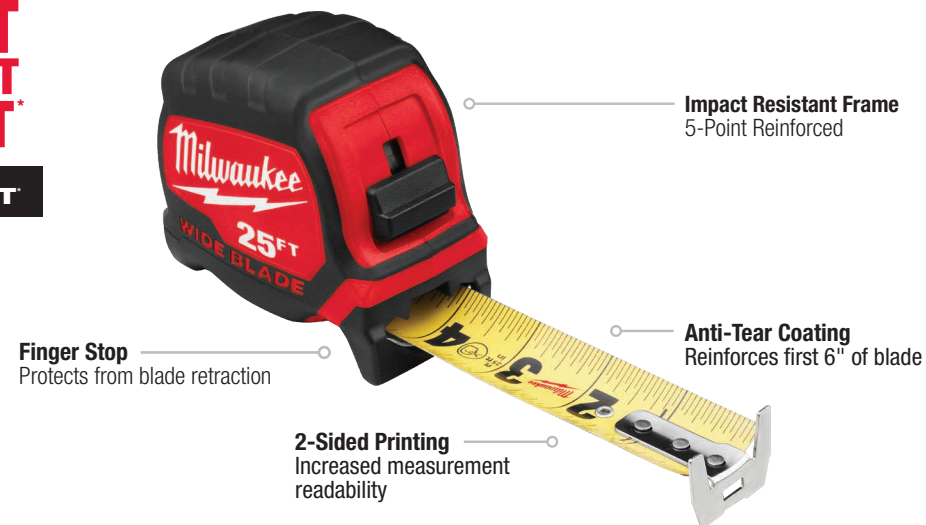

Long reach for efficient measuring

Model #	Description
48-22-0216	16ft Wide Blade Tape Measure
48-22-0225	25ft Wide Blade Tape Measure
48-22-0230	30ft Wide Blade Tape Measure
48-22-0235	35ft Wide Blade Tape Measure
48-22-0240	40ft Wide Blade Tape Measure

Model #	Description
48-22-0217	5m/16ft Wide Blade Tape Measure
48-22-0226	8m/26ft Wide Blade Tape Measure
48-22-0216M	16ft Wide Blade Magnetic Tape Measure
48-22-0225M	25ft Wide Blade Magnetic Tape Measure

*Based on maximum performance
**Functional After 80' Drop on Packed Soil

COMPACT WIDE BLADE TAPE MEASURES

12' STANDOUT

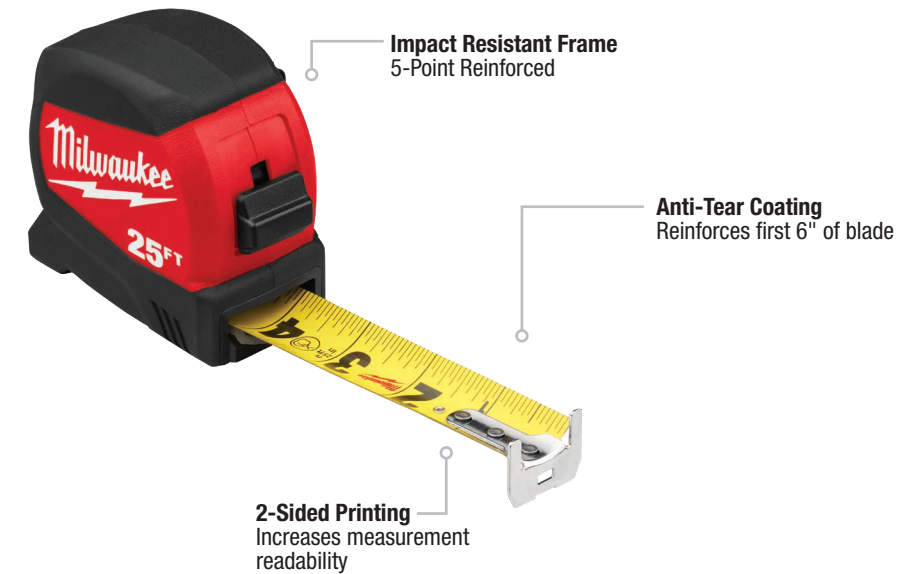

2-Sided Printing

Model #	Description
48-22-0416	16ft Compact Wide Blade Tape Measure
48-22-0425	25ft Compact Wide Blade Tape Measure
48-22-0430	30ft Compact Wide Blade Tape Measure
48-22-0417	5m/16ft Compact Wide Blade Tape Measure
48-22-0426	8m/26ft Compact Wide Blade Tape Measure

Model #	Description
48-22-0316	16ft Compact Wide Blade Magnetic Tape Measure
48-22-0325	25ft Compact Wide Blade Magnetic Tape Measure
48-22-0335	35ft Compact Wide Blade Magnetic Tape Measure
48-22-0317	5m/16ft Compact Wide Blade Magnetic Tape Measure
48-22-0326	8m/26ft Compact Wide Blade Magnetic Tape Measure

COMPACT TAPE MEASURES

9' STANDOUT



Nylon Blade Coating

Model #	Description
48-22-6612	12ft Compact Tape Measure
48-22-6616	16ft Compact Tape Measure
48-22-6625	25ft Compact Tape Measure
48-22-6630	30ft Compact Tape Measure
48-22-6613	3m/12ft Compact Tape Measure
48-22-6617	5m/16ft Compact Tape Measure
48-22-6626	8m/26ft Compact Tape Measure

Model #	Description
48-22-6816	16ft Compact Auto-Lock Tape Measure
48-22-6825	25ft Compact Auto-Lock Tape Measure
48-22-6817	5m/16ft Compact Auto-Lock Tape Measure
48-22-6826	8m/26ft Compact Auto-Lock Tape Measure
48-22-6625E	25ft Compact Tape Measure with Engineer Scale
48-22-5506	2m/6ft Keychain Tape Measure
48-22-6601	10ft/3m Keychain Tape Measure with LED

Also Available:



25ft Compact Tape Measure with Engineer Scale
48-22-6625E

REDSTICK™ COMPACT BOX LEVELS

COMPACT DURABILITY

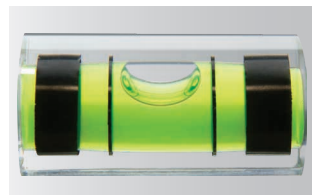

SHARPSITE™ Vial Technology

Model #	Description
MLCM24	24" REDSTICK™ Compact Box Level
MLCMM24	24" REDSTICK™ Magnetic Compact Box Level
MLCM48	48" REDSTICK™ Compact Box Level
MLCMM48	48" REDSTICK™ Magnetic Compact Box Level
MLCM72	72" REDSTICK™ Compact Box Level

Model #	Description
MLCMM72	72" REDSTICK™ Magnetic Compact Box Level
MLCMS48	24" / 48" REDSTICK™ Compact Box Level Set
MLCMSM48	24" / 48" REDSTICK™ Magnetic Compact Box Level Set

REDSTICK™ EXPANDABLE LEVELS

FRAME MORE. NO MAINTENANCE.



Reinforced Components & Durable Lock

Model #	Description
MLXPM78	48" – 78" REDSTICK™ Magnetic Expandable Level
MLXP712	6 1/2' – 12' REDSTICK™ Expandable Level



Also Available:
Expandable Level Storage Bag
MLXPSB

REDSTICK™ CONCRETE LEVELS

BUILT FOR CONCRETE



Screed

Smooth

Clean

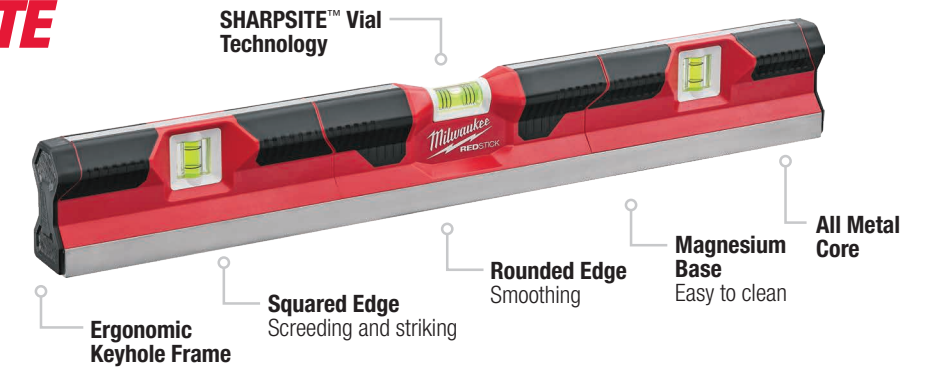

Model #	Description
MLCON24	24" REDSTICK™ Concrete Level
MLCON48	48" REDSTICK™ Concrete Level
MLCON72	72" REDSTICK™ Concrete Level

BILLET TORPEDO LEVELS

STRONGEST MAGNETS. EASIEST PITCH SET.



4 Amplified Rare-Earth Magnets

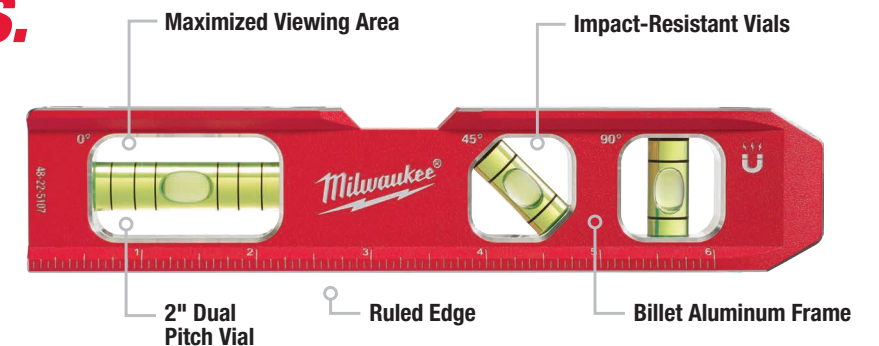

Model #	Description
48-22-5107	Billet Torpedo Level
48-22-5207	Metric Billet Torpedo Level

BLOCK TORPEDO LEVEL

STRONGEST MAGNETS. 360° ACCURACY.



Amplified Rare-Earth Magnets

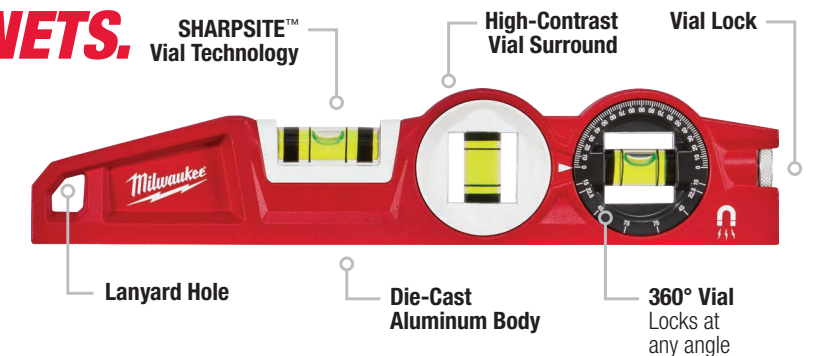

Model #	Description	Model #	Description
48-22-5210	Block Torpedo Level	48-22-5603	Pocket Level
48-22-5102	360° Pocket Level	48-22-5001	Pipe Lock Level

RAFTER SQUARES

**STRONGER FRAME.
MOST VERSATILE.**

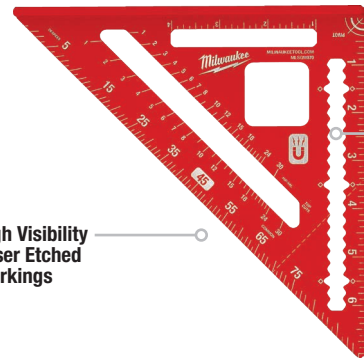

High Visibility Laser Etched Markings

Scribe Notches



1" Cutout Props Pipe

Model #	Description
MLSQM070	7" Magnetic Rafter Square
MLSQ170	180mm Rafter Square

TRIM SQUARE

**MOST COMPACT.
MOST VERSATILE.**



High Visibility Laser Etched Markings

Scribe Notches



Dual Reference Heel

Model #	Description
MLSQ040	4 1/2" Trim Square

FRAMING SQUARES

**STRONGER THAN STEEL.
MOST VERSATILE.**

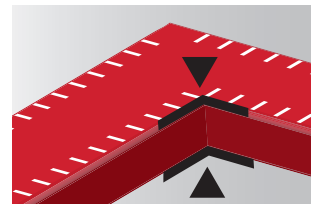

Thicker Frame

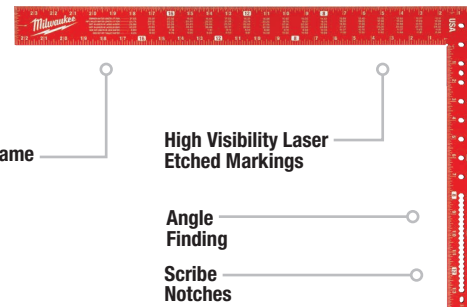

Reinforced Frame

High Visibility Laser Etched Markings

Angle Finding

Scribe Notches

Model #	Description
MLSQ024	16" x 24" Framing Square
MLSQ124	400mm x 600mm Framing Square

LASER DISTANCE METERS

EASIEST MEASUREMENTS



Simplified User Interface

2" Backlit Color Screen

Continuous Real-Time Measurements

2-Position Auto-Detecting Lever



Impact-Resistant Overmolding

Side-Shot Button
Allows for one-handed measurement in all situations

Also Available:



65ft Laser Distance Meter
48-22-9801

Model #	Description	Model #	Description
48-22-9801	65ft Laser Distance Meter	48-22-9803	330ft Laser Distance Meter
48-22-9802	150ft Laser Distance Meter		

FOLDING RULES

MOST DURABLE MARKINGS & BLADES

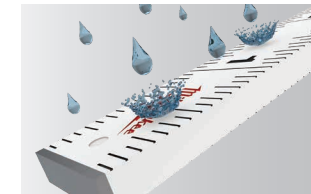

Water & Scratch Resistant Laminate

Quick Reference Bend Angles
22.5°, 30°, 45° & 60°

Heat-Stamped Markings
Won't wear

Corrosion-Free Embedded Joints
Locks at 0°, 90° & 180°



Model #	Description
48-22-3801	6-1/2ft Composite Folding Rule
48-22-3802	6-1/2ft Engineer's Composite Folding Rule

CHALK REELS

**LONGEST GEAR LIFE.
BEST PERFORMANCE.**



StripGuard™ Clutch & Planetary Gears



Bold Line

1.5mm High-Strength Braided Line

6X Faster Retraction



Fine Line

0.9mm High-Strength Braided Line

Aluminum Body
Fine line model only

Model #	Description	Model #	Description
48-22-3980	Bold Line Chalk Reel	48-22-3990	Fine Line Chalk Reel
48-22-3982	Bold Line Chalk Reel & Blue Chalk Refill	48-22-3992	Fine Line Chalk Reel & Blue Chalk Refill
48-22-3986	Bold Line Chalk Reel & Red Chalk Refill	48-22-3993	Chalk Reel Kit with Blue Chalk Refill
48-22-3989	Bold Replacement Line	48-22-3999	Fine Replacement Line

EXTRA BOLD LARGE CAPACITY CHALK REELS

**LONGEST GEAR LIFE.
BEST PERFORMANCE.**



Planetary Gears Prevent Stripping

24oz Chalk Capacity

4:1 Retraction Speed

Refillable Base



Easy Grip Metal Handle

Quick Turn Opening

Model #	Description	Model #	Description
48-22-3910	100ft Extra Bold Large Capacity Chalk Reel	48-22-3915	150ft Extra Bold Large Capacity Chalk Reel
48-22-3900	100ft Extra Bold Replacement Line	48-22-3905	150ft Extra Bold Replacement Line



INKZALL™ JOBSITE MARKERS

INKZALL™ JOBSITE MARKERS

**WRITES ON
DUST
WET
OILY
SURFACES**



Clog Resistant



Model #	Description
48-22-3150	12 Pc INKZALL™ Ultra Fine Point Black Jobsite Markers
48-22-3154	4 Pc INKZALL™ Ultra Fine Point Black Jobsite Markers
48-22-3104	4 Pc INKZALL™ Fine Point Black Jobsite Markers
48-22-3105	2 Pc INKZALL™ Fine Point Black Jobsite Markers
48-22-3107	8 Pc INKZALL™ Fine Point Color Jobsite Markers
48-22-3106	4 Pc INKZALL™ Fine Point Color Jobsite Markers
48-22-3101	INKZALL™ Stylus and Fine Point Black Jobsite Markers
48-22-3102	2 Pc INKZALL™ Medium Point Black Jobsite Markers
48-22-3103	INKZALL™ Chisel Tip Black Jobsite Markers
48-22-3109	4 Pc INKZALL™ Chisel Tip Color Jobsite Markers
48-22-3100	INKZALL™ Fine Point Black Jobsite Markers (Bulk 36 Pc)
48-22-3130	INKZALL™ Chisel Tip Black Jobsite Markers (Bulk 36 Pc)

Model #	Description
48-22-3170	INKZALL™ Fine Point Red Jobsite Markers (Bulk 36 Pc)
48-22-3180	INKZALL™ Fine Point Blue Jobsite Markers (Bulk 36 Pc)
48-22-3190	INKZALL™ Fine Point Green Jobsite Markers (Bulk 36 Pc)
48-22-3209	12 Pc INKZALL™ Fine Point Black Jobsite Markers
48-22-3250	3 Pc INKZALL™ Large Chisel Tip Black Jobsite Markers
48-22-3255	INKZALL™ Large Chisel Tip Black Jobsite Markers (Bulk 12 Pc)
48-22-3256	INKZALL™ Large Chisel Tip Red Jobsite Markers (Bulk 12 Pc)
48-22-3257	INKZALL™ Large Chisel Tip Blue Jobsite Markers (Bulk 12 Pc)
48-22-3260	INKZALL™ Extra Large Chisel Tip Black Jobsite Markers
48-22-3265	INKZALL™ Extra Large Chisel Tip Black Jobsite Markers (Bulk 12 Pc)
48-22-3266	INKZALL™ Extra Large Chisel Tip Red Jobsite Markers (Bulk 12 Pc)
48-22-3267	INKZALL™ Extra Large Chisel Tip Blue Jobsite Markers (Bulk 12 Pc)

INKZALL™ METALLIC MARKERS



Visible On Dark Surfaces



Model #	Description
48-22-3121	2 Pc INKZALL™ Fine Point Silver Metallic Marker
48-22-3122	2 Pc INKZALL™ Fine Point Gold Metallic Marker
48-22-3123	2 Pc INKZALL™ Fine Point Silver/Gold Metallic Marker



INKZALL™ PAINT MARKERS, PENS & HIGHLIGHTERS

INKZALL™ LIQUID PAINT MARKERS

**BLEED &
SMEAR
RESISTANT**

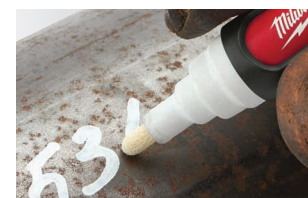

Marks on Surfaces up to 300°F

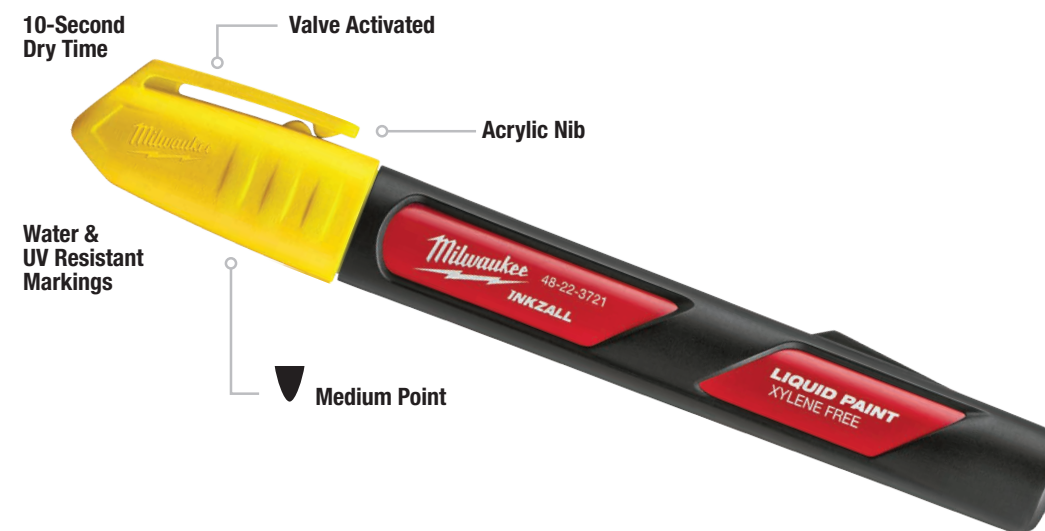

Model #	Description
48-22-3712	INKZALL™ Medium Point White Liquid Paint Marker
48-22-3722	INKZALL™ Medium Point Yellow Liquid Paint Marker
48-22-3711	INKZALL™ Medium Point White Liquid Paint Marker (Bulk 12 Pc)
48-22-3721	INKZALL™ Medium Point Yellow Liquid Paint Marker (Bulk 12 Pc)
48-22-3731	INKZALL™ Medium Point Black Liquid Paint Marker (Bulk 12 Pc)

Model #	Description
48-22-3741	INKZALL™ Medium Point Red Liquid Paint Marker (Bulk 12 Pc)
48-22-3751	INKZALL™ Medium Point Green Liquid Paint Marker (Bulk 12 Pc)
48-22-3761	INKZALL™ Medium Point Blue Liquid Paint Marker (Bulk 12 Pc)
48-22-3771	INKZALL™ Medium Point Orange Liquid Paint Marker (Bulk 12 Pc)

INKZALL™ JOBSITE PENS

**SHARP,
PRECISE
LINES**



Model #	Description
48-22-3160	12 Pc INKZALL™ Ultra Fine Point Black Jobsite Pen
48-22-3161	12 Pc INKZALL™ Ultra Fine Point Red Jobsite Pen
48-22-3162	12 Pc INKZALL™ Ultra Fine Point Blue Jobsite Pen
48-22-3164	4 Pc INKZALL™ Ultra Fine Point Black Jobsite Pen
48-22-3165	4 Pc INKZALL™ Ultra Fine Point Color Jobsite Pen

INKZALL™ JOBSITE HIGHLIGHTERS

**UP TO
4X LONGER LIFE**

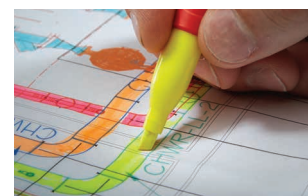

Model #	Description
48-22-3201	5 Pc INKZALL™ Chisel Tip Yellow Jobsite Highlighter
48-22-3206	5 Pc INKZALL™ Chisel Tip Colored Jobsite Highlighter

COMFORT GRIP STRAIGHT JAW PLIERS

**REAM
AND PUNCH™**



Ream

Punch



Model #	Description	Jaw Capacity	Reaming Capacity
48-22-6306	6" Comfort Grip Straight Jaw Pliers	1"	3/4"
48-22-6310	10" Comfort Grip Straight Jaw Pliers	2"	2"
48-22-6312	12" Comfort Grip Straight Jaw Pliers	2-1/4"	2-3/4"
48-22-6316	16" Comfort Grip Straight Jaw Pliers	4-1/4"	3"
48-22-6320	20" Comfort Grip Straight Jaw Pliers	5-1/2"	3-1/2"
48-22-6330	2 Pc 6" & 10" Comfort Grip Straight Jaw Pliers Set	1" & 2"	3/4" & 2"
48-22-6331	3 Pc Comfort Grip Pliers Set	2"	2"

STRAIGHT JAW PLIERS

**MAXIMUM GRIP.
FORGED STRENGTH.**



Reaming Head

Model #	Description	Jaw Capacity	Reaming Capacity
48-22-6510	10" Straight Jaw Pliers	2"	2"
48-22-6512	12" Straight Jaw Pliers	2-1/4"	2-3/4"

SMOOTH JAW PLIERS

**SMOOTH JAW
PROTECTS SURFACES**



Non-Marring Smooth Jaw for Finish Applications

Model #	Description	Jaw Capacity	Reaming Capacity
48-22-6550	10" Smooth Jaw Pliers	2"	2"
48-22-6552	12" Smooth Jaw Pliers	2-1/4"	2-3/4"

V-JAW PLIERS



Ream

Punch

Model #	Description	Jaw Capacity	Reaming Capacity
48-22-6208	8" Comfort Grip V-Jaw Pliers	1-1/2"	1-1/2"
48-22-6210	10" Comfort Grip V-Jaw Pliers	2"	2"
48-22-6212	12" Comfort Grip V-Jaw Pliers	2-3/4"	2-3/4"

LINEMAN'S PLIERS

**MAXIMUM LEVERAGE.
EASIER CUTS.***



Easily Cuts #2 ACSR
* When compared to other ACSR cutting lineman pliers

Model #	Description
48-22-6100	Comfort Grip High-Leverage Lineman's Pliers with Crimper
48-22-6500	High-Leverage Lineman's Pliers with Crimper
48-22-6502	High-Leverage Lineman's Pliers
48-22-6503	High-Leverage Lineman's Pliers with Thread Cleaner

ANGLED HEAD PLIERS

BETTER ACCESS



Angled Head

Model #	Description
48-22-6128	8" Comfort Grip Angled Head Diagonal Cutting Pliers
48-22-6528	8" Angled Head Diagonal Cutting Pliers

LONG NOSE PLIERS

LONG REACH



2" Gripping Nose



Also Available:
8" Long Nose Pliers
48-22-6501

Model #	Description
48-22-6101	8" Comfort Grip Long Nose Pliers
48-22-6501	8" Long Nose Pliers

DIAGONAL PLIERS

UP TO 2X MORE CUTS IRON-CARBIDE EDGE



Tapered Nose



Also Available:
8" Diagonal Cutting Pliers
48-22-6508

Model #	Description
48-22-6106	6" Comfort Grip Diagonal Cutting Pliers
48-22-6107	7" Comfort Grip Diagonal Cutting Pliers
48-22-6108	8" Comfort Grip Diagonal Cutting Pliers
48-22-6508	8" Diagonal Cutting Pliers

6 IN 1 COMBINATION PLIERS

6IN1

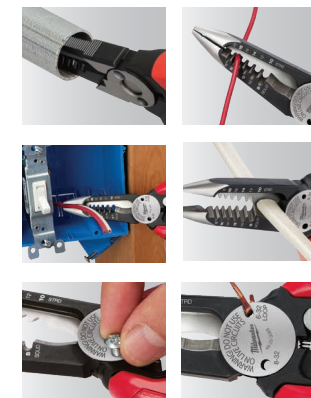
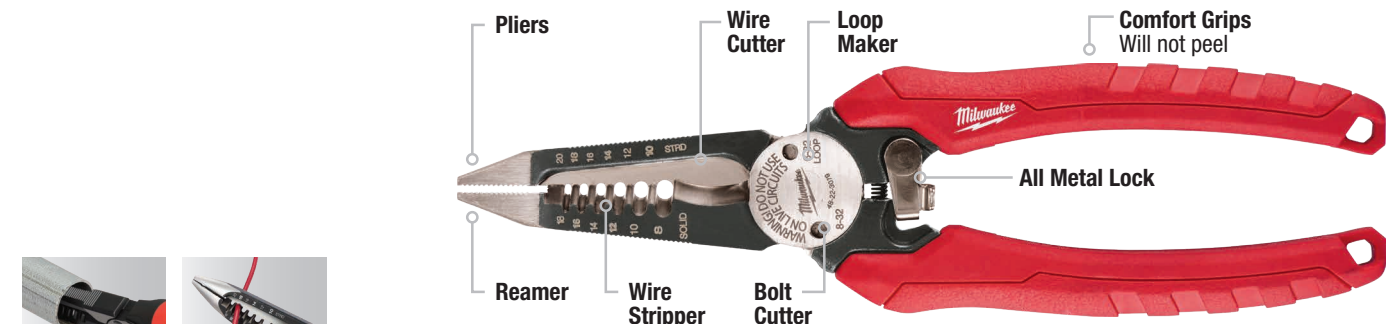

Model #	Description	Wire Stripper
48-22-3079	6in1 Comfort Grip Combination Pliers	8-18 AWG Solid, 10-20 AWG Stranded

MULTI-FUNCTION PLIERS

FAST, ONE-HANDED OPERATION

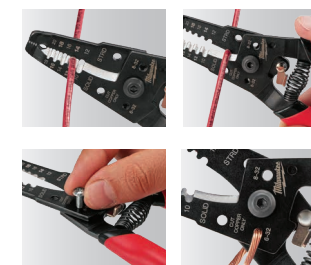
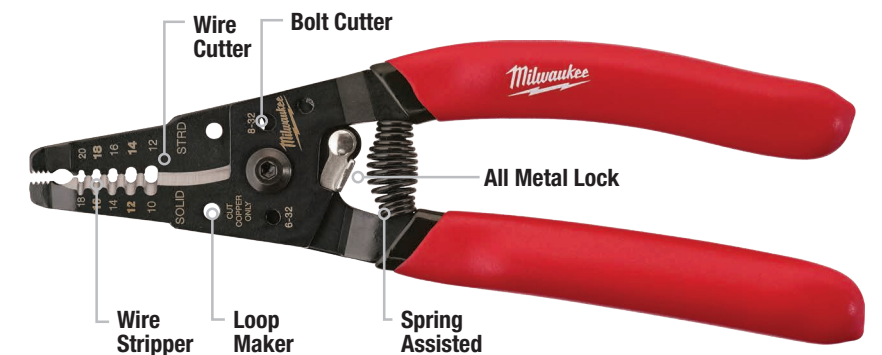

Model #	Description	Wire Stripper
48-22-6109	Wire Stripper	10-18 AWG Solid, 12-20 AWG Stranded
48-22-6579	Multi-Purpose Wire Stripper with Crimper	10-20 AWG Solid, 12-22 AWG Stranded

IRONWORKER'S PLIERS

UP TO **2X MORE CUTS**

IRON-CARBIDE EDGE



Comfort Grips
Will not peel



For Twisting & Cutting Rebar Ties

Model #	Description
48-22-6102	Ironworker's Pliers

CRIMPING PLIERS

UP TO **2X CRIMPING FORCE**



Reaming Head
Wire Cutter

Comfort Grips
Will not peel



Crimper for Insulated & Non-Insulated Terminals

Model #	Description
48-22-6103	Crimping Pliers

CABLE CUTTING PLIERS

CLEAN CUTS



Comfort Grips
Will not peel



Cuts up to 2/0 Cu, 4/0 Al

Model #	Description
48-22-6104	Cable Cutting Pliers

PVC / OIL FILTER PLIERS

3-1/2" JAW CAPACITY



Comfort Grips
Will not peel



Model #	Description
48-22-6321	PVC / Oil Filter Pliers

NIPPING PLIERS

CURVED HEAD PROTECTS SURFACES



Comfort Grips
Will not peel



Blades Will Not Mar Surfaces

Model #	Description
48-22-6407	7" Nipping Pliers

FENCING PLIERS

FORGED STRENGTH



Staple Gripper
Wire Cutter
Wire Crimper
Hammer

Comfort Grips
Will not peel



Wire Puller

Model #	Description
48-22-6410	Fencing Pliers

TORQUE LOCK™ FASTER SET-UP

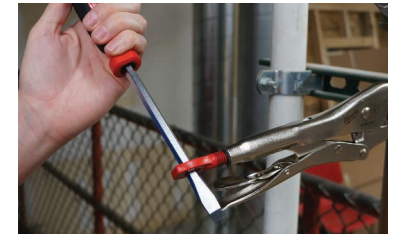

LOCKING PLIERS WITH MAX BITE™

MAX BITE™
3X GRIPPING FORCE



CHROME
Chrome plated rust protection



GRIPPED
Rubber overmold

Model #	Description
48-22-3607	7" MAX BITE™ Curved Jaw Locking Pliers
48-22-3610	10" MAX BITE™ Curved Jaw Locking Pliers
48-22-3702	2 Pc 7" & 10" Locking Pliers with MAX BITE™

Model #	Description
48-22-3710	10" Locking Pliers with Grip with MAX BITE™
48-22-3707	7" Locking Pliers with Grip with MAX BITE™

LOCKING PLIERS



CURVED JAW
Maximizes pressure points for any bolt, nut or locking tool application



STRAIGHT JAW
Maximizes contact points on jobsite work surfaces



LONG NOSE
Best for long reach applications

Model #	Description
48-22-3405	5" TORQUE LOCK™ Curved Jaw Locking Pliers with Grip
48-22-3407	7" TORQUE LOCK™ Curved Jaw Locking Pliers with Grip
48-22-3410	10" TORQUE LOCK™ Curved Jaw Locking Pliers with Grip
48-22-3406	6" TORQUE LOCK™ Long Nose Locking Pliers with Grip
48-22-3409	9" TORQUE LOCK™ Long Nose Locking Pliers with Grip
48-22-3807	7" TORQUE LOCK™ Straight Jaw Locking Pliers with Grip
48-22-3810	10" TORQUE LOCK™ Straight Jaw Locking Pliers with Grip
48-22-3402	2 Pc 7" & 10" TORQUE LOCK™ Curved Jaw Locking Pliers with Grip Set
48-22-3602	2 Pc. 10" Curved Jaw & 6" Long Nose TORQUE LOCK™ Locking Pliers Set
48-22-3423	4" TORQUE LOCK™ Curved Jaw Locking Pliers

Model #	Description
48-22-3422	5" TORQUE LOCK™ Curved Jaw Locking Pliers
48-22-3421	7" TORQUE LOCK™ Curved Jaw Locking Pliers
48-22-3420	10" TORQUE LOCK™ Curved Jaw Locking Pliers
48-22-3504	4" TORQUE LOCK™ Long Nose Locking Pliers
48-22-3506	6" TORQUE LOCK™ Long Nose Locking Pliers
48-22-3507	7" TORQUE LOCK™ Straight Jaw Locking Pliers
48-22-3509	9" TORQUE LOCK™ Long Nose Locking Pliers
48-22-3510	10" TORQUE LOCK™ Straight Jaw Locking Pliers
48-22-3541	12" TORQUE LOCK™ Large Jaw Locking Pliers

C-CLAMPS & SPECIALTY

STANDARD JAW C-CLAMP
Greater clamping versatility on a variety of shapes and surfaces



SWIVEL JAW C-CLAMP
Pads provide surface stabilization and protect work surfaces from damage



Model #	Description
48-22-3521	11" Swivel Jaw Locking C-Clamp
48-22-3522	6" Swivel Jaw Locking C-Clamp
48-22-3531	11" Locking C-Clamp
48-22-3532	6" Locking C-Clamp
48-22-3520	18" Swivel Jaw Locking C-Clamp
48-22-3529	18" Deep Reach Locking C-Clamp
48-22-3530	18" Locking C-Clamp

Model #	Description
48-22-3540	8" Locking Seamer
48-22-3542	9" Locking Chain Wrench
48-22-3543	9" Locking Welding Clamp
48-22-3523	9" Deep Reach Swivel Jaw Locking C-Clamp
48-22-3533	9" Deep Reach Locking C-Clamp
48-22-3631	11" Locking C-Clamp
48-22-3632	6" Locking C-Clamp

CHEATER ADAPTABLE PIPE WRENCH

3 LENGTH DESIGN

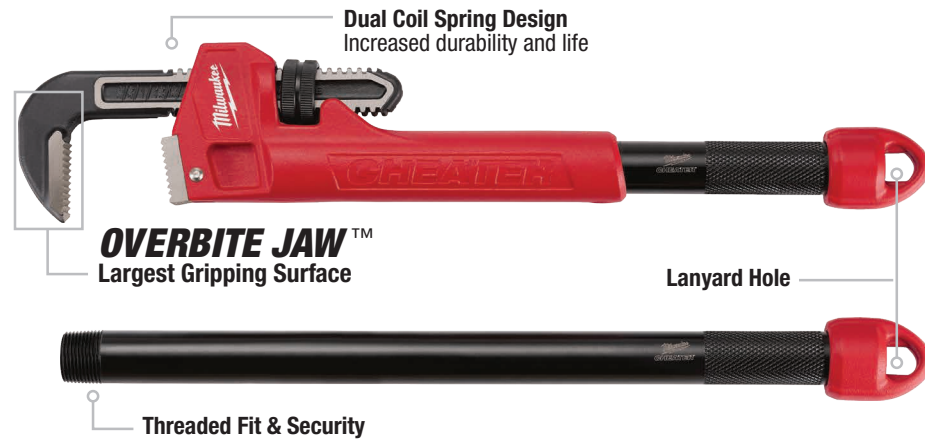

Model #	Description	Material	Max Jaw Capacity
48-22-7314	CHEATER Adaptable Pipe Wrench	Steel	2-1/2"

10L ALUMINUM PIPE WRENCH WITH POWERLENGTH™ HANDLE

BETTER ACCESS. MAXIMUM LEVERAGE.



Model #	Description	Material	Max Jaw Capacity
48-22-7313	10L Aluminum Pipe Wrench w/POWERLENGTH™ Handle	Aluminum	1-1/2"

STEEL & ALUMINUM PIPE WRENCHES

LARGEST GRIP SURFACE



Steel



Aluminum

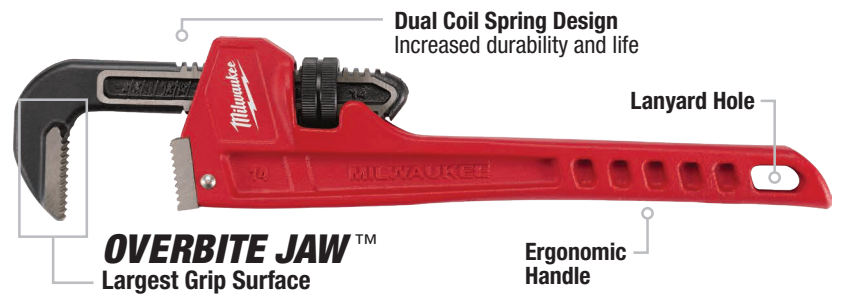

Model #	Description	Length	Material	Max Jaw Capacity	Model #	Description	Length	Material	Max Jaw Capacity
48-22-7106	6" Steel Pipe Wrench	6"	Steel	3/4"	48-22-7148	48" Steel Pipe Wrench	48"	Steel	6"
48-22-7108	8" Steel Pipe Wrench	8"	Steel	1"	48-22-7160	60" Steel Pipe Wrench	60"	Steel	8"
48-22-7110	10" Steel Pipe Wrench	10"	Steel	1-1/2"	48-22-7210	10" Aluminum Pipe Wrench	10"	Aluminum	1-1/2"
48-22-7112	12" Steel Pipe Wrench	12"	Steel	2"	48-22-7212	12" Aluminum Pipe Wrench	12"	Aluminum	2"
48-22-7114	14" Steel Pipe Wrench	14"	Steel	2"	48-22-7214	14" Aluminum Pipe Wrench	14"	Aluminum	2"
48-22-7118	18" Steel Pipe Wrench	18"	Steel	2-1/2"	48-22-7218	18" Aluminum Pipe Wrench	18"	Aluminum	2-1/2"
48-22-7124	24" Steel Pipe Wrench	24"	Steel	3"	48-22-7224	24" Aluminum Pipe Wrench	24"	Aluminum	3"
48-22-7136	36" Steel Pipe Wrench	36"	Steel	5"	48-22-7236	36" Aluminum Pipe Wrench	36"	Aluminum	5"
					48-22-7248	48" Aluminum Pipe Wrench	48"	Aluminum	6"

STEEL OFFSET HEX PIPE WRENCH

SMOOTH JAW WON'T MAR SURFACES

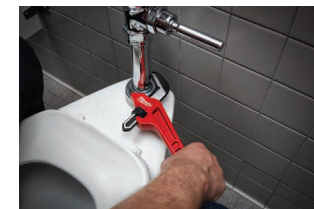

Protects Chrome Surfaces



Model #	Description	Material	Max Jaw Capacity
48-22-7171	Steel Offset Hex Pipe Wrench	Steel	2-5/8"

STEEL SMOOTH JAW PIPE WRENCH

SMOOTH JAW PROTECTS SURFACES



Protects Chrome Surfaces



Model #	Description	Material	Max Jaw Capacity
48-22-7186	12" Steel Smooth Jaw Pipe Wrench	Steel	2-5/8"

ALUMINUM OFFSET HEX PIPE WRENCHES

BETTER ACCESS



Offset Head



Model #	Description	Material	Max Jaw Capacity
48-22-7184	14" Aluminum Offset Pipe Wrench	Aluminum	2"
48-22-7185	18" Aluminum Offset Pipe Wrench	Aluminum	2"
48-22-7182	24" Aluminum Offset Pipe Wrench	Aluminum	3"

ADJUSTABLE WRENCHES

JAWS WON'T BACK OFF
Proprietary Screw

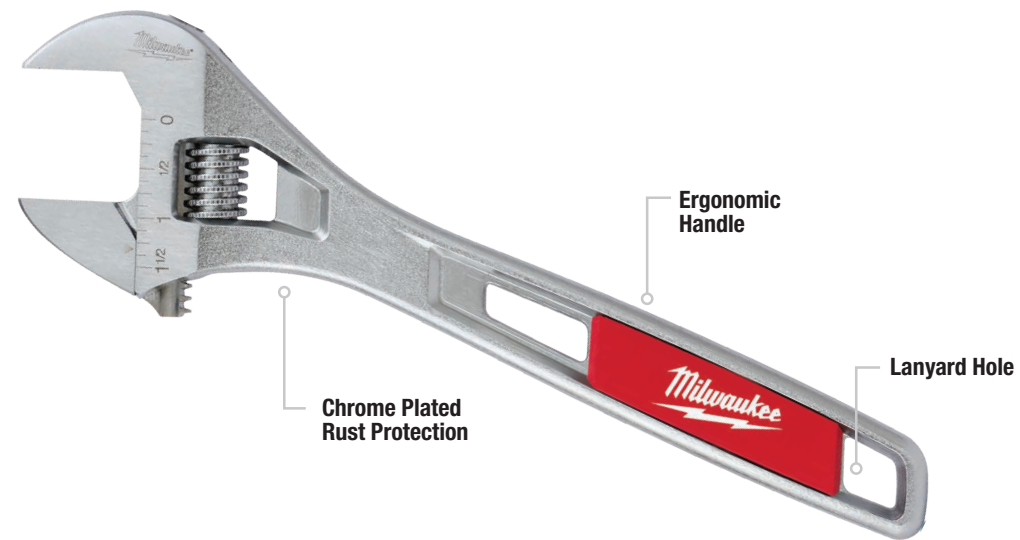
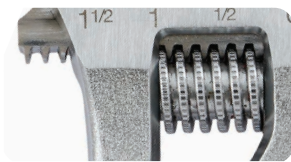

Perfectly Parallel Jaws

Model #	Description
48-22-7400	2 Pc 6" & 10" Adjustable Wrench Set
48-22-7406	6" Adjustable Wrench
48-22-7408	8" Adjustable Wrench
48-22-7410	10" Adjustable Wrench
48-22-7412	12" Adjustable Wrench
48-22-7415	15" Adjustable Wrench
48-22-7508	8" Wide Jaw Adjustable Wrench

BASIN WRENCHES

EASIEST SWAP-OUTS



Ratchet-Ready
Less jaw readjusting



Screwdriver-Ready
Up to 2x breakaway torque

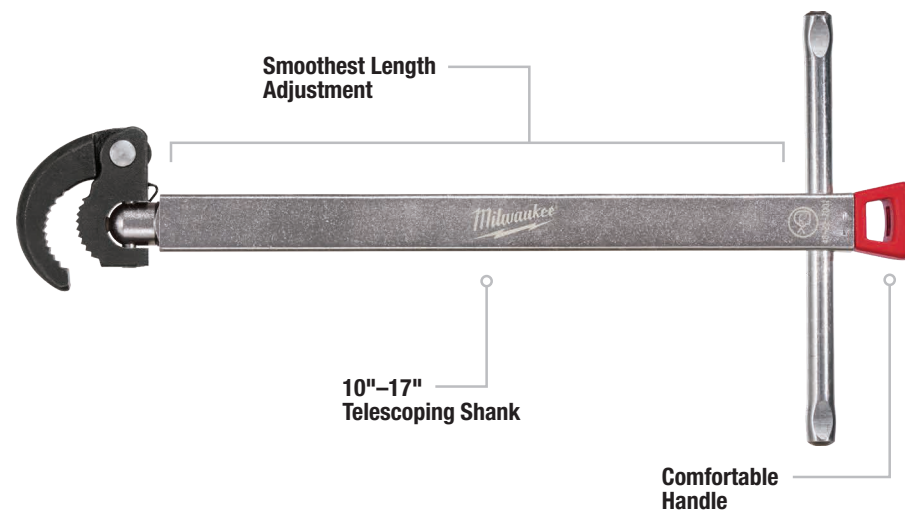

Model #	Description
48-22-7001	1-1/4" Basin Wrench
48-22-7002	2-1/2" Basin Wrench

CONTRACTOR RATCHET & SOCKET SETS

VERSATILE DESIGN. BETTER ACCESS.

SAE METRIC

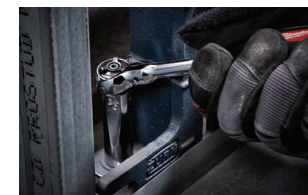

Pivoting Head

Model #	Description
48-22-9000	12 Pc 3/8" SAE Contractor Ratchet & Socket Set with FOUR FLAT™ Sides
48-22-9001	12 Pc 3/8" Metric Contractor Ratchet & Socket Set with FOUR FLAT™ Sides

MECHANICS RATCHET & SOCKET SETS

MOST VERSATILE SOCKETS. ANTI-ROLL, WRENCH-READY.

SAE METRIC

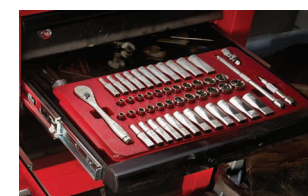

Removable Storage Trays

MET Part #	Description
48-22-9404	26 Pc 1/4" SAE Drive Ratchet & Sockets with FOUR FLAT™ Sides
48-22-9408	28 Pc 3/8" SAE Drive Ratchet & Sockets with FOUR FLAT™ Sides
48-22-9504	28 Pc 1/4" Metric Drive Ratchet & Sockets with FOUR FLAT™ Sides
48-22-9014	1/4" Drive Ratchet
48-22-9508	32 Pc 3/8" Metric Drive Ratchet & Sockets with FOUR FLAT™ Sides
48-22-9004	50 Pc Metric & SAE 1/4" Drive Ratchet & Sockets with FOUR FLAT™ Sides
48-22-9008	56 Pc Metric & SAE 3/8" Drive Ratchet & Sockets with FOUR FLAT™ Sides
48-22-9038	3/8" Drive Ratchet

RATCHETING COMBINATION WRENCHES

BETTER ACCESS. LONGEST LIFE.



Model #	Description	Included Sizes
48-22-9406	7 Pc SAE Ratcheting Combination Wrench Set	3/8", 7/16", 1/2", 9/16", 5/8", 11/16", 3/4"
48-22-9506	7 Pc Metric Ratcheting Combination Wrench Set	8mm, 10mm, 12mm, 13mm, 14mm, 15mm, 17mm
48-22-9416	15 Pc SAE Ratcheting Combination Wrench Set	1/4", 9/32", 5/16", 11/32", 3/8", 7/16", 1/2", 9/16", 5/8", 11/16", 3/4", 13/16", 7/8", 15/16", 1"
48-22-9516	15 Pc Metric Ratcheting Combination Wrench Set	8mm, 9mm, 10mm, 11mm, 12mm, 13mm, 14mm, 15mm, 16mm, 17mm, 18mm, 19mm, 20mm, 21mm, 22mm

COMBINATION WRENCHES

UP TO 25% MORE TORQUE

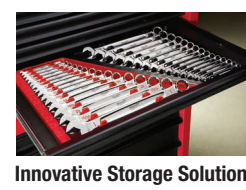

Model #	Description	Included Sizes
48-22-9407	7 Pc SAE Combination Wrench Set	3/8", 7/16", 1/2", 9/16", 5/8", 11/16", 3/4"
48-22-9507	7 Pc Metric Combination Wrench Set	8mm, 10mm, 12mm, 13mm, 14mm, 15mm, 17mm
48-22-9415	15 Pc SAE Combination Wrench Set	1/4", 9/32", 5/16", 11/32", 3/8", 7/16", 1/2", 9/16", 5/8", 11/16", 3/4", 13/16", 7/8", 15/16", 1"
48-22-9515	15 Pc Metric Combination Wrench Set	8mm, 9mm, 10mm, 11mm, 12mm, 13mm, 14mm, 15mm, 16mm, 17mm, 18mm, 19mm, 20mm, 21mm, 22mm

PRY BARS

UP TO 40% MORE PRYING STRENGTH

I-BEAM DESIGN

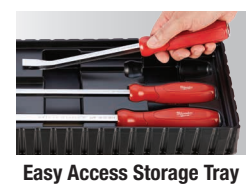
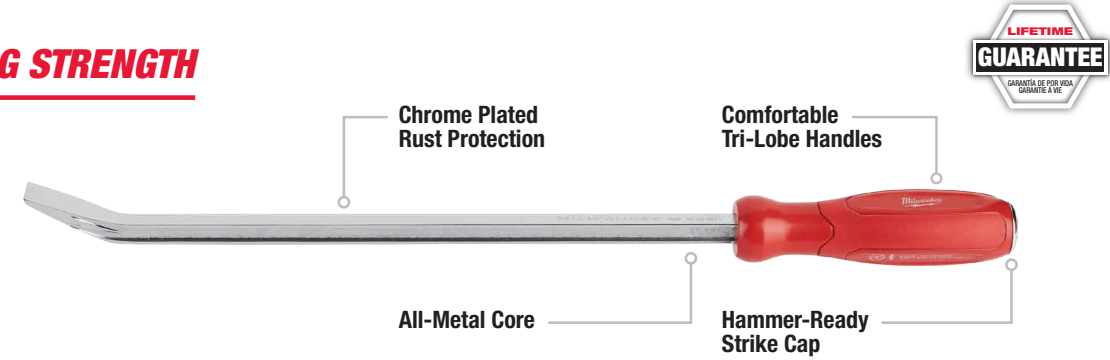

Model #	Description	Included Lengths
48-22-9214	4 Pc Pry Bar Set	8", 12", 18", 24"

HOOK AND PICK SET

UP TO 50% MORE DURABLE
ALL-METAL CORE

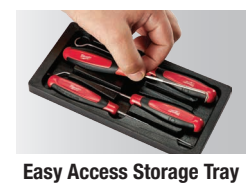

Model #	Description	Includes
48-22-9215	4 Pc Hook and Pick Set	Straight Pick, Offset Hook, Hook, 90° Hook

9 IN 1 MULTI-BIT / KEY DRIVERS

9in1

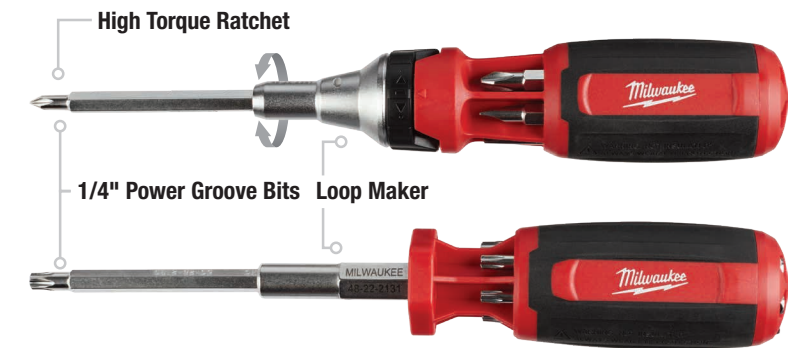

Model #	Description	Nut Drivers	Bit Types
48-22-2131	9in1 Multi-Bit Driver w/ ECX™	1/4"	P#1, P#2, SL 3/16", SL 1/4", SQ#2, ECX™#1, ECX™#2
48-22-2132	9in1 Square Multi-Bit Driver	1/4"	P#1, P#2, SL 3/16", SL 1/4", SQ#1, SQ#2, SQ#3
48-22-2331	9in1 Ratchet Multi-Bit Driver w/ ECX™	1/4"	P#1, P#2, SL 3/16", SL 1/4", SQ#2, ECX™#1, ECX™#2
48-22-2322	9in1 Ratchet Multi-Bit Driver w/ Square	1/4"	P#1, P#2, SL 3/16", SL 1/4", SQ#1, SQ#2, SQ#3
48-22-2133	9in1 TORX® Key Driver	1/4"	T8, T10, T15, T20, T25, T27, T30
48-22-2134	9in1 SAE Hex Key Driver	1/4"	7/64", 1/8", 9/64", 5/32", 3/16", 7/32", 1/4"
48-22-2136	9in1 Metric Hex Key Driver	1/4"	1.5mm, 2mm, 2.5mm, 3mm, 4mm, 5mm, 6mm
48-22-2110	4 Pc Replacement Bit Set		P#1, P#2, SL 3/16", SL 1/4", SQ #1, SQ#1, ECX™#1

8 IN 1 COMPACT MULTI-BIT DRIVERS

8in1



Model #	Description	Nut Drivers	Bit Types
48-22-2130	Compact 8in1 Multi-Bit Driver	1/4"	P#1, P#2, SL 3/16", SL 1/4", SQ#1, SQ#2, T15
48-22-2330	Compact 8in1 Ratchet Multi-Bit Driver	1/4"	P#1, P#2, SL 3/16", SL 1/4", SQ#1, SQ#2, T15

11 IN 1 MULTI-BIT DRIVERS

11in1

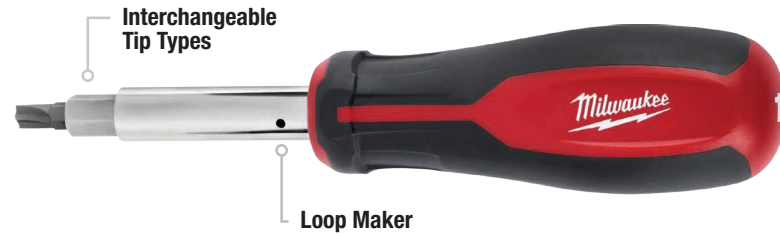

Comfortable Tri-Lobe Handle

Model #	Description	Nut Drivers	Bit Types
48-22-2760	11in1 Multi-Bit Driver w/ ECX™	1/4", 5/16", 3/8"	P#1, P#2, SL 3/16", SL 1/4", SQ#1, SQ#2, ECX™#1, ECX™#2
48-22-2761	11in1 Multi-Bit Driver w/ TORX®	1/4", 5/16", 3/8"	P#1, P#2, SL 3/16", SL 1/4", SQ#1, SQ#2, T10, T15

13 IN 1 CUSHION-GRIP SCREWDRIVERS

13in1

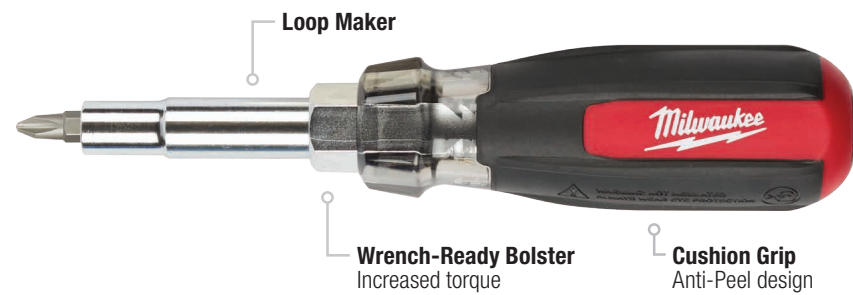

ECX™ Bit



Schrader® Valve Core Remover

Model #	Description	Nut Drivers	Bit Types
48-22-2880	13in1 Cushion-Grip Screwdriver with ECX™ Bit	1/4", 5/16", 3/8", 1/2"	P#1, P#2, SL 3/16", SL1/4", SQ#1, SQ#2, ECX™#1, ECX™#2
48-22-2881	13in1 Cushion-Grip Screwdriver with Schrader® Bit	1/4", 5/16", 3/8", 1/2"	P#1, P#2, SL 3/16", SL1/4", SQ#1, SQ#2, Std Schrader®, Large Schrader®

SCREWDRIVERS

HIGH-LEVERAGE HANDLE. MAGNETIC TIP.



Also Available:



Bottle Opener
48-22-2700



Comfortable Tri-Lobe Handle

Model #	Description	Bit Types
48-22-2702	2 Pc Demolition Screwdriver Set	P#2, SL 5/16"
48-22-2706	6 Pc Screwdriver Set	P#1, P#2, SL 3/16", SL 1/4", SL 5/16"
48-22-2708	8 Pc Screwdriver Set w/ ECX™	P#1, P#2, SL 3/16", SL 1/4", SL 5/16", ECX™#1, ECX™#2
48-22-2710	10 Pc Screwdriver Set	P#1, P#2, SL 3/16", SL 1/4", SL 5/16", SQ#1, SQ#2
48-22-2718	8 Pc Screwdriver Set w/ Square	P#1, P#2, SL 3/16", SL 1/4", SL 5/16", SQ#1, SQ#2
48-22-2700	Bottle Opener	

CUSHION-GRIP SCREWDRIVERS

MOST DURABLE HANDLE. PRECISION TIP.

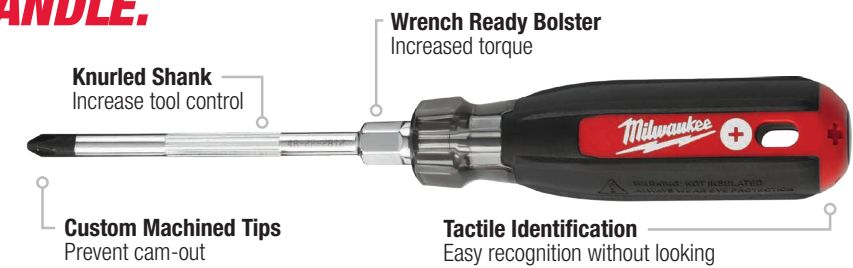

Anti-Peel Design Cushion Grips

Model #	Description	Model #	Description	Model #	Description
48-22-2811	#1 Phillips (3")	48-22-2821	1/4" Slotted (4")	48-22-2841	#1 ECX™ (4")
48-22-2812	#2 Phillips (4")	48-22-2822	5/16" Slotted (6")	48-22-2842	#2 ECX™ (4")
48-22-2813	#3 Phillips (6")	48-22-2824	3/8" Slotted (8")	48-22-2851	#1 Square (3")
48-22-2814	#2 Phillips (10")	48-22-2831	3/16" Cabinet (3")	48-22-2852	#2 Square (4")
48-22-2815	#2 Phillips (6")	48-22-2832	3/16" Cabinet (6")	48-22-2853	#3 Square (6")
	Cushion-Grip Demolition Screwdriver	48-22-2833	3/16" Cabinet (8")	48-22-2884	4 Pc Set
		48-22-2834	1/4" Cabinet (10")	48-22-2886	6 Pc Set

DEMO DRIVER

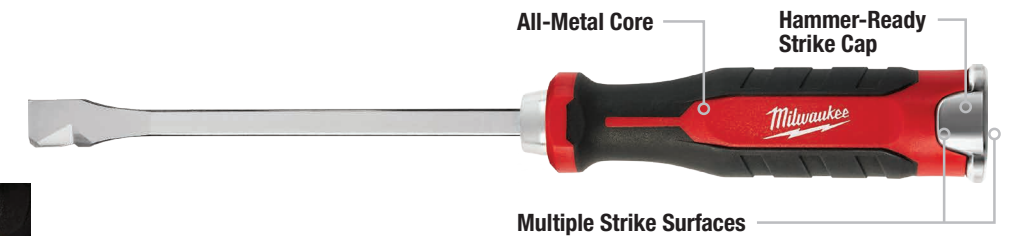

Aggressive Duct Piercing Tip

Model #	Description
48-22-2860	Demo Driver
48-22-2823	Slotted 5/16" 6" Cushion-Grip Demolition Screwdriver
48-22-2825	Slotted 3/8" 8" Cushion-Grip Demolition Screwdriver

1000V INSULATED SCREWDRIVERS



Dual Layer Insulation

Flame & Impact Resistant

1000V
IEC 60900:2012 | ASTM F1505-10 | NFPA 70E

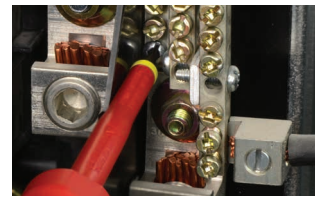

Slim Drive Shaft
Allows access in recessed applications

Model #	Description	Model #	Description	Model #	Description	Bit Types, Carrying Case
48-22-2211	#1 Phillips (3")	48-22-2232	3/16" Cabinet (6")	48-22-2202	3 Pc 1000V Insulated Screwdriver Set	P#2, SL 1/4", ECX™#1
48-22-2212	#2 Phillips (4")	48-22-2233	3/16" Cabinet (8")	48-22-2204	4 Pc 1000V Insulated Screwdriver Set w/ Case	P#1, P#2, SL 1/4", SL 3/8", Extra Capacity Roll Up Pouch
48-22-2213	#3 Phillips (6")	48-22-2241	#1 ECX™ (4")	48-22-2205	4 Pc 1000V Insulated Screwdriver Set w/ Case	SL 1/4", SL 3/8", SQ#1, SQ#2, Extra Capacity Roll Up Pouch
48-22-2221	1/4" Slotted (6")	48-22-2242	#2 ECX™ (4")	48-22-2210	10 Pc 1000V Insulated Screwdriver Set w/ Case	P#1, P#2, P#3, SL 1/4", SL 5/16", SL 3/8", SQ#1, SQ#2, SQ#3, ECX™#1, EVA Foam Fitted Case
48-22-2222	5/16" Slotted (7")	48-22-2251	#1 Square (3")	48-22-2203	3 Pc 1000V Insulated Screwdriver Set	#1 ECX™ (4"), #2 Phillips (4"), 1/4" Slotted (6")
48-22-2223	3/8" Slotted (8")	48-22-2252	#2 Square (4")			
48-22-2224	3/8" Slotted (10")	48-22-2253	#3 Square (6")			
48-22-2231	3/16" Cabinet (4")					

PRECISION SCREWDRIVERS

UP TO **4X STRONGER**

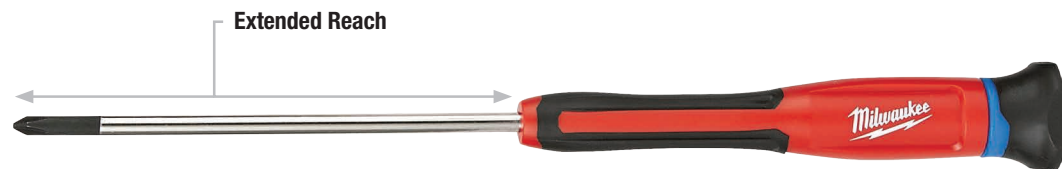

Extended Reach

360° Rotating & Impact Resistant Back Cap

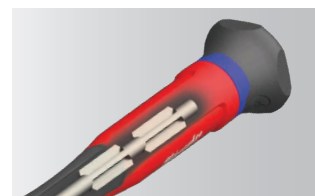

All-Metal Core

Model #	Description	Bit Types
48-22-2604	4 Pc Precision Screwdriver Set	P#1, SL 1/16", SL 3/32", SL 1/8"
48-22-2606	6 Pc Precision Screwdriver Set w/ Case	P#1, P#2, SL 1/16", SL 3/32", SL 1/8", SL 5/32"
48-22-2610	6 Pc TORX® Precision Screwdriver Set w/ Case	T6, T7, T8, T9, T10, T15

HOLLOWCORE™ MAGNETIC NUT DRIVERS

UNLIMITED DEPTH
FITS **4X MORE FASTENERS**

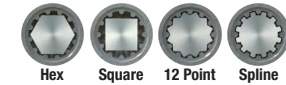

SAE METRIC

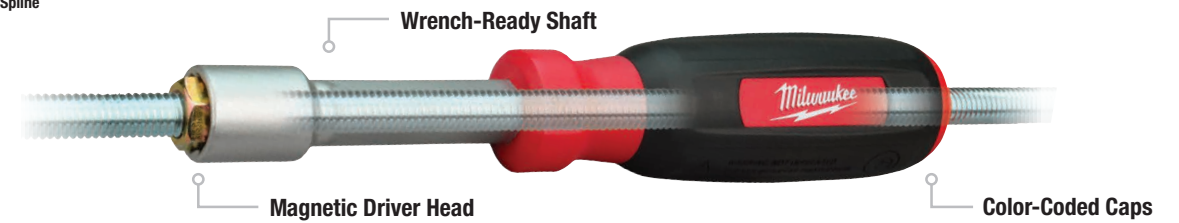

Wrench-Ready Shaft

Magnetic Driver Head

Color-Coded Caps

Model #	Description
48-22-2520	3/16" Magnetic Nut Driver
48-22-2521	1/4" HOLLOWCORE™ Magnetic Nut Driver
48-22-2522	5/16" HOLLOWCORE™ Magnetic Nut Driver
48-22-2523	11/32" HOLLOWCORE™ Magnetic Nut Driver
48-22-2524	3/8" HOLLOWCORE™ Magnetic Nut Driver

Model #	Description	Sizes
48-22-2502	2 Pc HOLLOWCORE™ Magnetic Nut Driver Set	1/4", 5/16"
48-22-2507	7 Pc HOLLOWCORE™ SAE Magnetic Nut Driver Set	1/4", 5/16", 11/32", 3/8", 7/16", 1/2", 9/16"
48-22-2517	7 Pc HOLLOWCORE™ Metric Magnetic Nut Driver Set	5mm, 5.5mm, 6mm, 7mm, 8mm, 10mm, 13mm

Model #	Description
48-22-2525	7/16" HOLLOWCORE™ Magnetic Nut Driver
48-22-2526	1/2" HOLLOWCORE™ Magnetic Nut Driver
48-22-2527	9/16" HOLLOWCORE™ Magnetic Nut Driver
48-22-2531	5mm HOLLOWCORE™ Magnetic Nut Driver
48-22-2532	5.5mm HOLLOWCORE™ Magnetic Nut Driver

Model #	Description
48-22-2533	6mm HOLLOWCORE™ Magnetic Nut Driver
48-22-2534	7mm HOLLOWCORE™ Magnetic Nut Driver
48-22-2535	8mm HOLLOWCORE™ Magnetic Nut Driver
48-22-2536	10mm HOLLOWCORE™ Magnetic Nut Driver
48-22-2537	13mm HOLLOWCORE™ Magnetic Nut Driver

HOLLOW SHAFT NUT DRIVERS

FITS **4X MORE FASTENERS**

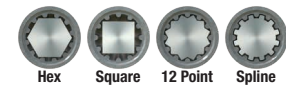

SAE METRIC

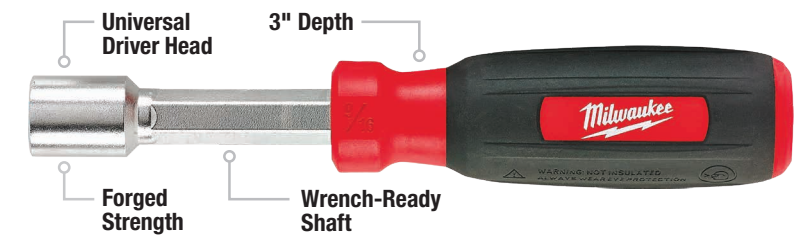

Universal Driver Head

3" Depth

Forged Strength

Wrench-Ready Shaft

Model #	Description	Sizes
48-22-2402	2 Pc SAE Hollow Shaft Nut Driver Set	1/4", 5/16"
48-22-2404	4 Pc SAE Hollow Shaft Nut Driver Set	1/4", 5/16", 7/16", 9/16"
48-22-2407	7 Pc SAE Hollow Shaft Nut Driver Set	1/4", 5/16", 11/32", 3/8", 7/16", 1/2", 9/16"
48-22-2417	7 Pc Metric Hollow Shaft Nut Driver Set	5mm, 5.5mm, 6mm, 7mm, 8mm, 10mm, 13mm

Model #	Description
48-22-2420	3/16" Hollow Shaft Nut Driver
48-22-2421	1/4" Hollow Shaft Nut Driver
48-22-2422	5/16" Hollow Shaft Nut Driver
48-22-2423	11/32" Hollow Shaft Nut Driver
48-22-2424	3/8" Hollow Shaft Nut Driver

Model #	Description
48-22-2425	7/16" Hollow Shaft Nut Driver
48-22-2426	1/2" Hollow Shaft Nut Driver
48-22-2427	9/16" Hollow Shaft Nut Driver
48-22-2431	5mm Hollow Shaft Nut Driver
48-22-2432	5.5mm Hollow Shaft Nut Driver

Model #	Description
48-22-2433	6mm Hollow Shaft Nut Driver
48-22-2434	7mm Hollow Shaft Nut Driver
48-22-2435	8mm Hollow Shaft Nut Driver
48-22-2436	10mm Hollow Shaft Nut Driver
48-22-2437	13mm Hollow Shaft Nut Driver

FRAMING HAMMERS

UP TO **10x VIBRATION REDUCTION**
SHOCKSHIELD™ GRIP

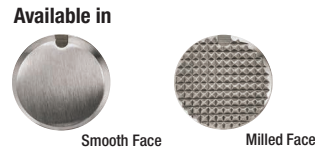

Magnetic Nail Set

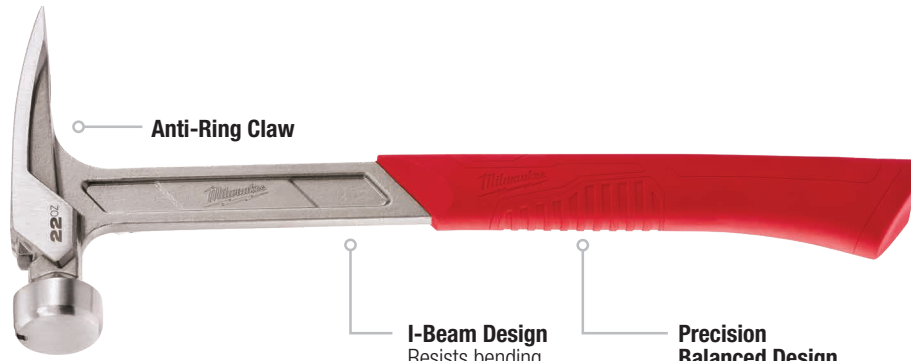

Model #	Description
48-22-9016	17oz Milled Face Hammer
48-22-9017	17oz Smooth Face Hammer
48-22-9022	22oz Milled Face Hammer

Model #	Description
48-22-9023	22oz Smooth Face Hammer
48-22-9080	20oz Curved Claw Hammer

POLY FIBERGLASS HAMMER

MOST DURABLE FIBERGLASS HANDLE

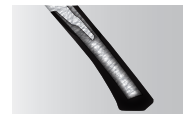

Reinforced Fiberglass Handle

Model #	Description
48-22-9316	19oz Smooth Face Poly Fiberglass Hammer

HICKORY HAMMER

BEST DRIVING PERFORMANCE



Magnetic Nail Set

Model #	Description
48-22-9419	19oz Hickory Hammer - Milled Face
48-22-9419	19oz Hickory Hammer - Smooth Face

HARDLINE™ POCKET KNIVES

EXTREME WEAR RESISTANCE™



Model #	Description
48-22-1994	HARDLINE™ 3" Smooth Blade Pocket Knife
48-22-1997	HARDLINE™ 2-1/2" Smooth Blade Pocket Knife

Model #	Description
48-22-1998	HARDLINE™ 3" Serrated Blade Pocket Knife
48-22-1999	HARDLINE™ 3-1/2" Smooth Blade Pocket Knife

HARDLINE™ FIXED BLADE KNIVES

ULTIMATE DURABILITY™
AUS-8 STEEL



Multi-Position Sheath



Model #	Description
48-22-1928	5" HARDLINE™ Fixed Blade Knife
48-22-1928B	5" HARDLINE™ Fixed Blade Knife

FASTBACK™ SPRING ASSISTED KNIVES

Spring Assisted



Ideal for Piercing & Tearing



Also Available:



FASTBACK™ Camo Spring Assisted Knife
48-22-1996

Model #	Description
48-22-1995	FASTBACK™ Spring Assisted Knife
48-22-1996	FASTBACK™ Camo Spring Assisted Knife

FASTBACK™ FLIP KNIVES

PRESS AND FLIP™



Ideal for Controlled Slicing



Model #	Description
48-22-1985	FASTBACK™ Hawkbill Flip Knife
48-22-1990	FASTBACK™ Flip Knife

LOCKBACK POCKET KNIFE

Lockback Strong Secure Hold

Model #	Description
48-22-1940	Lockback Pocket Knife

FASTBACK™ FLIP UTILITY KNIVES

PRESS AND FLIP™

Quick Change

Model #	Description
48-22-1903	FASTBACK™ Flip Utility Knife with Blade Storage
48-22-1901	FASTBACK™ Flip Utility Knife
48-22-1906	FASTBACK™ Compact Flip Utility Knife

LINEMAN'S HAWKBILL KNIVES

STAYS SHARPER LONGER

Universal Hot Stick Compatible

Also Available:
4" Fixed Blade Knife 48-22-1926

Model #	Description
48-22-1923	Lineman's Hawkbill Knife with STICKWORK™ 3in1 Ring
48-22-1924	Lineman's Blunt Tip Hawkbill Knife with STICKWORK™ 3in1 Ring

FASTBACK™ HAWKBILL FLIP KNIVES

PRESS AND FLIP™

Ideal for Piercing & Tearing

Model #	Description
48-22-1985	FASTBACK™ Hawkbill Flip Knife

FIXED BLADE KNIVES

STAYS SHARPER LONGER

Durable Sheath

Model #	Description
48-22-1925	Hawkbill Fixed Blade Knife

LINEMAN'S UNDERGROUND KNIFE

STAYS SHARPER LONGER

Blade Cover Storage

Model #	Description
48-22-1929	Lineman's Underground Knife
48-22-1926	4" Fixed Blade Knife

SIDE SLIDING UTILITY KNIFE

MAXIMUM DEPTH CONTROL

Ergonomic Handle

Model #	Description
48-22-1910	Side Sliding Utility Knife

SAFETY UTILITY KNIFE

SAFETY CUTTER

UP TO **5X LONGER LIFE**

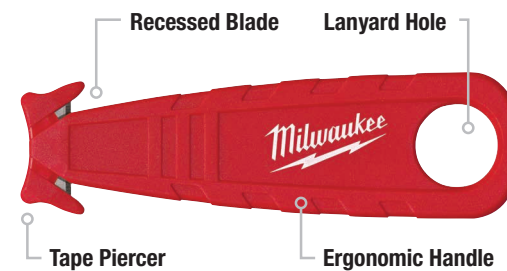

2 Blade Positions

Model #	Description
48-22-1915	Safety Utility Knife

Model #	Description
48-22-1916	Safety Cutter

PRECISION SNAP-OFF KNIFE

METAL LOCK
UP TO **10X LONGER LIFE**

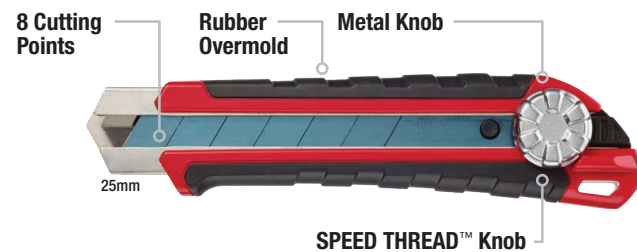

Model #	Description
48-22-1960	9mm (A) Precision Snap-Off Knife
48-22-1961	18mm (L) Precision Snap-Off Knife w/ Metal Lock

Model #	Description
48-22-1962	25mm (H) Precision Snap-Off Knife w/ Metal Lock

Description	3 Pc	10 Pc
9mm (A) Precision Snap-Off Replacement Blades	48-22-9309	48-22-9109
18mm (L) Precision Snap-Off Replacement Blades	48-22-9318	48-22-9118
25mm (H) Precision Snap-Off Replacement Blades	48-22-9325	48-22-9125

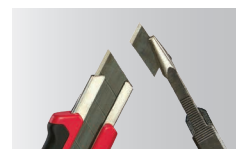

Blade Snap Off

GENERAL PURPOSE SNAP-OFF KNIFE

FASTER BLADE ADJUSTMENT

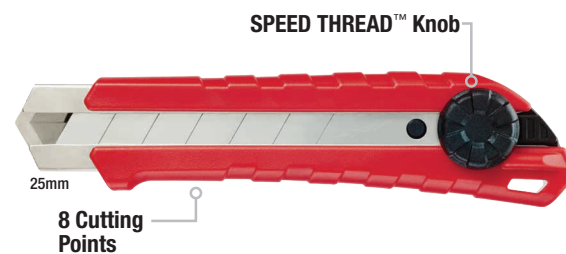

Model #	Description
48-22-1963	9mm (A) General Purpose Snap-Off Knife
48-22-1964	18mm (L) General Purpose Snap-Off Knife

Model #	Description
48-22-1965	25mm (H) General Purpose Snap-Off Knife

Description	3 Pc	10 Pc
9mm (A) General Purpose Snap-Off Replacement Blades	48-22-1309	48-22-1109
18mm (L) General Purpose Snap-Off Replacement Blades	48-22-1318	48-22-1118
25mm (H) General Purpose Snap-Off Replacement Blades	48-22-1325	48-22-1125



Blade Snap Off

GENERAL PURPOSE

LASTS **5X LONGER**



General Purpose



HOOK

UP TO **2X STRONGER**



Ideal for Roofing



DRYWALL

UP TO **2X SHARPER**



Ideal for Drywall



CARTON

LASTS **5X LONGER**



Ideal for Cartons



Description	5 Pc	15 Pc (Case Included)	50 Pc (Dispenser Included)	75 Pc (Dispenser Included)	100 Pc (Dispenser Included)
General Purpose Utility Blades	48-22-1905	-	48-22-1950	48-22-1975	48-22-1900
Hook Utility Blades	48-22-1932	-	48-22-1952	-	-
Drywall Utility Blades	48-22-1933	-	48-22-1953	-	-
Carton Utility Blades	48-22-1934	-	48-22-1954	-	-
15 Pc Assorted Utility Blade Set	-	48-22-1930 (10) General Purpose, (2) Hook, (3) Carton	-	-	-

INSULATION KNIVES

STAYS SHARPER LONGER

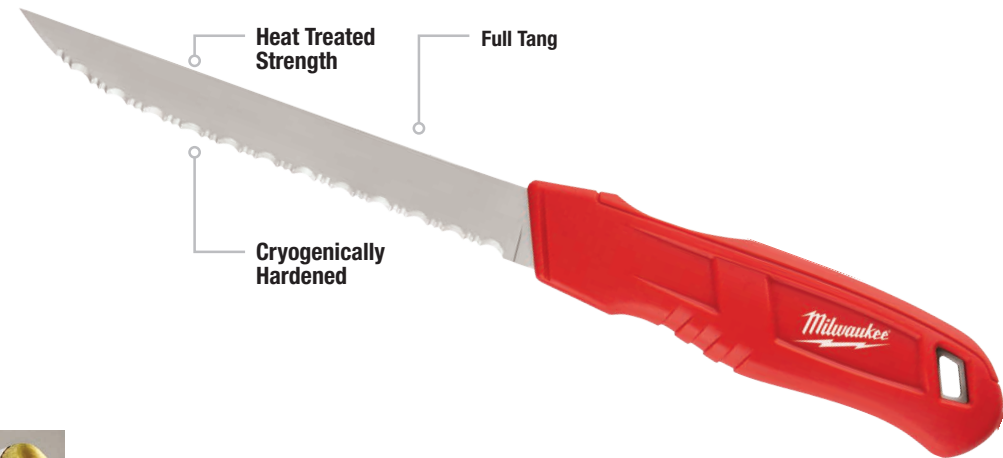

Rounded Handle
Smoothing Applications

Model #	Description
48-22-1921	Insulation Knife (Smooth)
48-22-1922	Insulation Knife (Serrated)

DUCT KNIFE

STAYS SHARPER LONGER

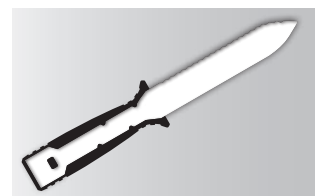
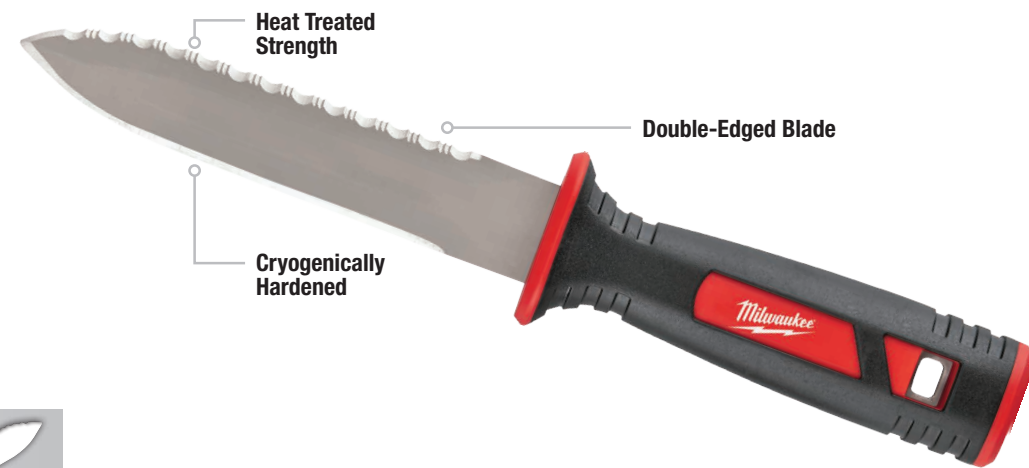

Full Tang

Model #	Description
48-22-1920	Duct Knife

AVIATION SNIPS

UP TO 10x MORE CUTS FORGED BLADES



Flush Bolt Design
Won't hang up on material

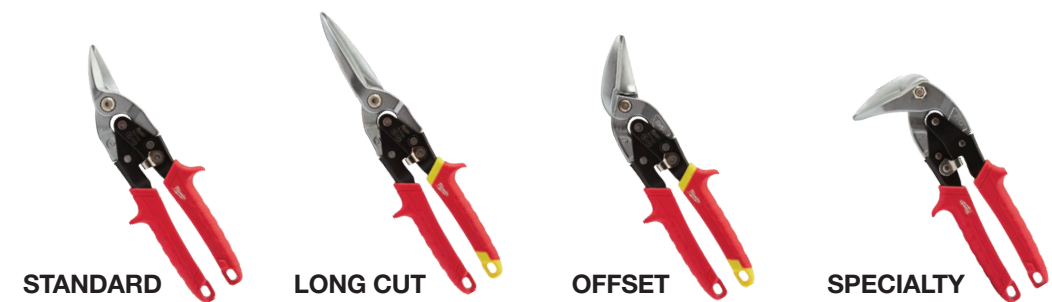

Model #	Description	Cold Rolled Steel	Stainless Steel
48-22-4530	Straight Cutting Standard Snips	18ga	22ga
48-22-4510	Left Cutting Standard Snips	18ga	22ga
48-22-4520	Right Cutting Standard Snips	18ga	22ga
48-22-4533	3 Pc Standard Snips Set	18ga	22ga
48-22-4532	Straight Cutting Offset Snips	18ga	22ga
48-22-4512	Left Cutting Offset Snips	18ga	22ga
48-22-4522	Right Cutting Offset Snips	18ga	22ga

Model #	Description	Cold Rolled Steel	Stainless Steel
48-22-4523	2 Pc Offset Snips Set	18ga	22ga
48-22-4537	Long Cut Straight Cutting Snips	20ga	22ga
48-22-4538	Long Cut Offset Snips	20ga	22ga
48-22-4500	Bulldog Snips	16ga	18ga
48-22-4511	Left Cutting Right Angle Snips	24ga	28ga
48-22-4521	Right Cutting Right Angle Snips	24ga	28ga

OFFSET COMPOUND TINNERS

TOUGH CUTS

2X FORCE, LESS EFFORT

BOLT LOCK



45° Offset Cut clearance

Model #	Description
48-22-4005	Offset Compound Tinner

CLASSIC TINNERS

BLADES WILL NOT LOOSEN

BOLT LOCK



40% Larger Handle Loops

Model #	Description
48-22-4003	10" Classic Tinner
48-22-4002	12" Classic Tinner
48-22-4001	16" Bulldog Tinner

DUCKBILL TINNER

BLADES WILL NOT LOOSEN

BOLT LOCK



40% Larger Handle Loops

Model #	Description
48-22-4004	10" Duckbill Tinner

LIGHTWEIGHT TINNER

STRAIGHTER, CLEANER CUTS



40% Larger Handle Loops

Model #	Description
48-22-4006	13" Lightweight Tinner
48-22-4007	Lightweight Tinner Replacement Blades

JOBSITE SCISSORS

ALL-METAL HANDLES

UP TO 10X LONGER LIFE



Index Finger Groove

Model #	Description
48-22-4040	Offset Jobsite Scissors (Serrated)

Model #	Description
48-22-4041	Straight Jobsite Scissors (Smooth)

SPEED SEAMER™

FASTER, MORE ACCURATE HVAC FOLDS



3/8" & 1" Markings More accurate folds

Model #	Description
48-22-6000	3" SPEED SEAMER™

CRIMPER

UP TO 2X LONGER LIFE



Symmetrical Handles Over-hand grip

Model #	Description
48-22-6001	5-Blade Crimper

ADAPTABLE BOLT CUTTERS W/ POWERMOVE™ EXTENDABLE ARMS

**MORE CUTS.
MAXIMUM VERSATILITY.**



POWERMOVE™
Extendable Arms

Model #	Description	Max Capacity	
		Soft/Medium Materials (up to 31 HRC)	Hard Materials (up to 48 HRC)
48-22-4114	14" Adaptable Bolt Cutter	5/16"	3/16"
48-22-4124	24" Adaptable Bolt Cutter	7/16"	5/16"

BOLT CUTTERS

**MORE CUTS.
LONGER LIFE.**

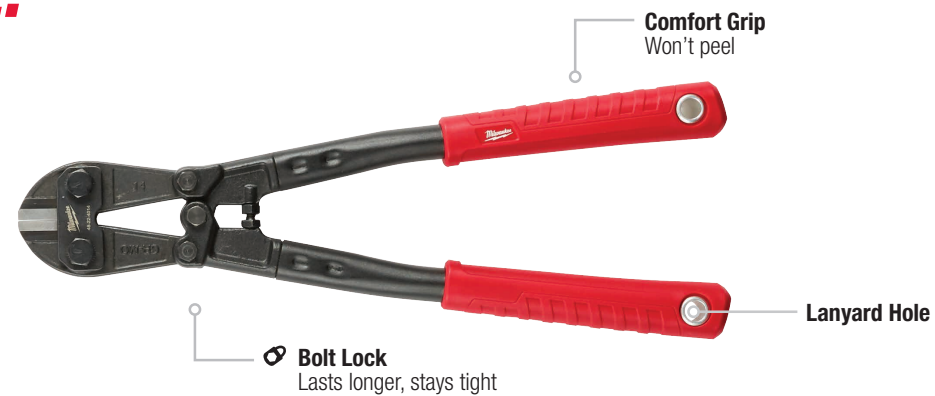

Forged Steel Blades &
Custom Heat Treated
Maximum durability

Model #	Description	Max Capacity	
		Soft/Medium Materials (up to 31 HRC)	Hard Materials (up to 48 HRC)
48-22-4014	14" Bolt Cutter	5/16"	3/16"
48-22-4024	24" Bolt Cutter	7/16"	5/16"

HIGH-TENSION HACKSAW

**MOST DURABLE.
HIGHEST TENSION.**

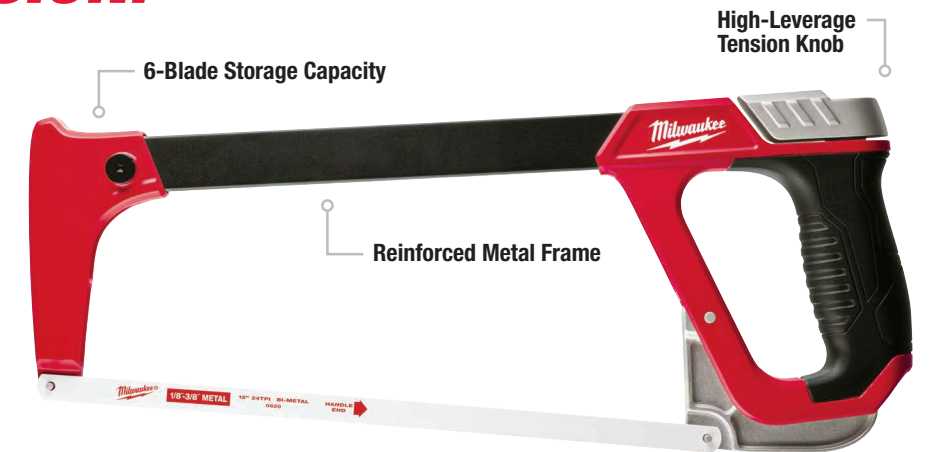

45° Angle Blade Position

Model #	Description
48-22-0050	10 Pc 12" High-Tension Hacksaw
48-43-0600	10 Pc 12" 14TPI Hacksaw Blade
48-43-0610	10 Pc 12" 18TPI Hacksaw Blade

Model #	Description
48-43-0620	10 Pc 12" 24TPI Hacksaw Blade
48-43-0630	10 Pc 12" 32TPI Hacksaw Blade

COMPACT HACKSAW

UP TO 10X FASTER BLADE CHANGE



Compact Design

Model #	Description
48-22-0012	Compact Hacksaw

RASPING JAB SAW

UP TO **2X FASTER PLUNGE CUTS**



Piercing Tip

Model #	Description
48-22-0304	Rasping Jab Saw

FOLDING JAB SAW

UP TO **10X FASTER BLADE CHANGE**



Folding Blade

Model #	Description
48-22-0305	Folding Jab Saw

PVC/ABS SAW

FAST CUTS THROUGH PVC



Metal Core

Model #	Description
48-22-0212	12" PVC/ABS Saw
48-22-0222	12" PVC/ABS Saw Replacement Blade
48-22-0223	18" PVC/ABS Saw
48-22-0220	18" PVC/ABS Saw Replacement Blade

TUBING CUTTER

INDESTRUCTIBLE FRAME



Replaceable Blades

Model #	Description
48-22-4202	Tubing Cutter
48-22-4203	Tubing Cutter Replacement Blade

RATCHETING PIPE CUTTERS

STRAIGHT, EASY CUTS



Comfortable Handle Design

Model #	Description	Model #	Description
48-22-4210	1-5/8" Ratcheting Pipe Cutter	48-22-4215	2-3/8" Ratcheting Pipe Cutter
48-22-4211	1-5/8" Ratcheting Pipe Cutter Replacement Blade	48-22-4216	2-3/8" Ratcheting Pipe Cutter Replacement Blade

REAMING PEN

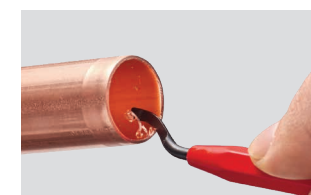

Copper



PVC



Model #	Description
48-22-4255	Reaming Pen

MINI COPPER TUBING CUTTERS

5X LONGER LIFE
REINFORCED ADJUSTMENT MECHANISM



Chrome Rollers Rust Protection

Model #	Description	Cut Capacity	Extra Blade
48-22-4250	1/2" Mini Copper Tubing Cutter	1/8"–5/8"	—
48-22-4258	3/4" Mini Copper Tubing Cutter	1/8"–7/8"	—
48-22-4251	1" Mini Copper Tubing Cutter	1/8"–1-1/8"	Yes
48-22-4256	2 Pc Replacement Cutter Wheels	—	—

CLOSE QUARTERS COPPER TUBING CUTTERS

MOST COMPACT.
LONGEST LIFE.



Additional Storage Blades and reaming pen



Chrome Rollers Rust Protection

Model #	Description
48-22-4260	1/2" Close Quarters Copper Tubing Cutter
48-22-4261	3/4" Close Quarters Copper Tubing Cutter
48-22-4262	1" Close Quarters Copper Tubing Cutter
48-22-4263	3 Pc Close Quarters Copper Tubing Cutter Set
48-22-4266	Replacement Copper Tubing Cutter Wheels

QUICK-ADJUST TUBING CUTTERS

STRAIGHTER,
CLEANER CUTS
4 CHROME ROLLERS



Adapt to Cut 3" PEX



Chrome Rollers Rust Protection

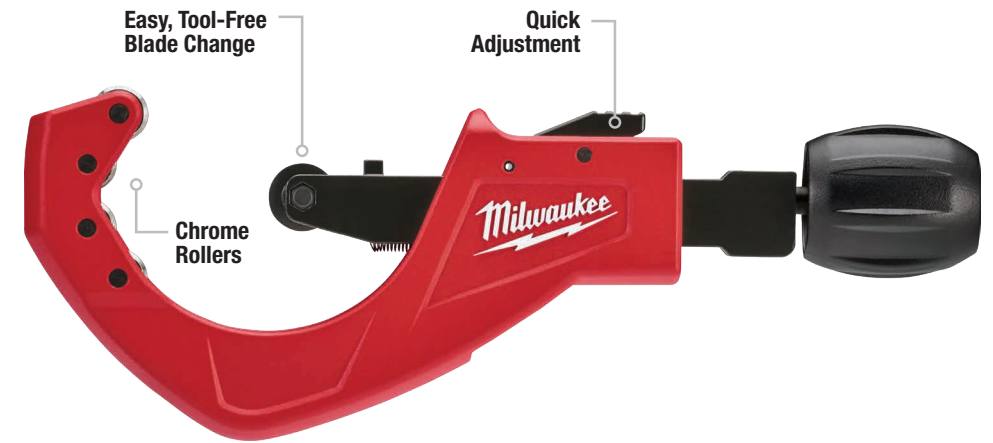

Model #	Description	Cut Capacity
48-22-4253	2-1/2" Quick-Adjust Copper Tubing Cutter	1/2"–2-5/8"
48-22-4254	3-1/2" Quick-Adjust Copper Tubing Cutter	1/2"–3-1/2"
48-22-4256	2 Pc Replacement Cutter Wheels	—
48-22-4206	Replacement PEX Cutter Wheel	—

CONSTANT SWING COPPER TUBING CUTTERS

STRAIGHTER,
CLEANER CUTS
4 CHROME ROLLERS



Built-In Reamer on 48-22-4252



Chrome Rollers Rust Protection



Model #	Description	Cut Capacity
48-22-4259	1" Constant Swing Copper Tubing Cutter	1/8"–1-1/8"
48-22-4252	1-1/2" Constant Swing Copper Tubing Cutter	1/8"–1-5/8"
48-22-4256	2 Pc Replacement Cutter Wheels	—
48-22-4257	3 Pc Replacement Reaming Blade	—

PUNCHDOWN TOOL

BEST ACCESS & VISIBILITY



Integrated LED Light

High / Low Impacting Function

Also Available:



Extended Reach Punchdown Blade
48-22-2166

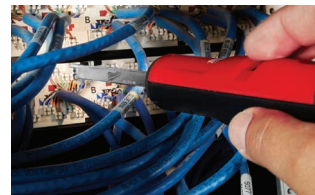

Extended Reach Punchdown Blade

Model #	Description	Blades Included
48-22-2165	Punchdown Tool with Extended Blade	66/110 Combination and Extended Reach 110
48-22-2166	Extended Punchdown Blade	Extended Reach 110
48-22-2167	Punchdown Blade	66/110 Combination

MINI FLUSH CUTTER

CONSISTENT, PRECISE CUTS



Light Weight



Spring Assisted

Model #	Description
48-22-6105	Mini Flush Cutter

RATCHETING MODULAR CRIMPER

CONSISTENT, ACCURATE CRIMPS



In-Line Head Design

Easy Access Jack Removal

Ratcheting Mechanism



Parallel Crimping Design

Model #	Description
48-22-3075	Ratcheting Modular Crimper

MULTI-PICK TOOL

4in1



Anti-Roll Grip

Storage Cap

Spudger

Wire Pick & Hook

1/8" Slotted

#0 Phillips



Model #	Description
48-22-2145	Multi-Pick Tool

ELECTRICIAN SNIPS

BLADES WON'T LOOSEN. BOLT LOCK



Forged Blade

All-Metal Handles

Optimized Finger Loop



Wire Gullet Prevents Walking

Model #	Description
48-22-4045	Electrician Snips

UTP STRIPPER

COMFORTABLE, ONE HAND OPERATION



Spring Assisted Stripping

Adjustable Blade Height



Optimized Finger Loop

Model #	Description
48-22-3065	UTP Stripper

CONDUIT BENDER

HIGH CONTRAST MARKINGS
BEST VISIBILITY



Reinforced Multi-Position Foot Pedal

Model #	Description
48-22-4080	1/2" Iron Conduit Bender
48-22-4081	3/4" Iron Conduit Bender
48-22-4082	1" Iron Conduit Bender
48-22-4070	1/2" Aluminum Conduit Bender
48-22-4071	3/4" Aluminum Conduit Bender

FISH STICKS

MOST DURABLE CONNECTIONS.
BRIGHTEST GLOW.



Reinforced Threaded Connection Points



MET Part #	Description	Kit Includes
48-22-4149	5ft Low Flex Fish Stick	(1) 5' Low Flex Fish Stick, and Bullet Nose
48-22-4150	15ft Low Flex Fish Stick Kit	(3) 5' Low Flex Fish Sticks, Storage Tube, Bullet Nose and Hook
48-22-4151	5ft Mid Flex Fish Stick	(1) 5' Mid Flex Fish Stick, and Bullet Nose
48-22-4152	15ft Mid Flex Fish Stick Kit	(3) 5' Mid Flex Fish Sticks, Storage Tube, Bullet Nose and Hook
48-22-4153	5ft High Flex Fish Stick	(1) 5' High Flex Fish Stick, and Bullet Nose
48-22-4154	15ft High Flex Fish Stick Kit	(3) 5' High Flex Fish Sticks, Storage Tube, Bullet Nose and Hook

MET Part #	Description	Kit Includes
48-22-4160	25ft Fish Stick Combo Kit	(4) 5' Low Flex, (1) 5' Mid Flex Fish Sticks, (1) Storage Tube, Bullet Nose and Hook
48-22-4155	30ft Fish Stick Combo Kit	(4) 5' Low Flex, (1) 5' Mid Flex, (1) 5' High Flex Fish Sticks, (1) Storage Case, Bullet Nose, Hook, and Whisk
48-22-4156	60ft Fish Stick Combo Kit	(7) 5' Low Flex, (3) 5' Mid Flex, (2) 5' High Flex Fish Sticks, (1) Storage Case, Bullet Nose, Hook, Whisk, Magnet & Chain and Lighted Tip
48-22-4157	3 PC. Fish Stick Accessory Kit	(1) Whisk, Bullet Nose, and Hook
48-22-4158	Fish Stick Lighted Tip Accessory	(1) Lighted Tip Accessory
48-22-4159	Fish Stick Magnetic Tip and Chain Accessory	(1) Magnetic Tip and (1) Chain Accessory

POLYESTER FISH TAPES

EASIEST FISHING.
MORE DURABLE TAPE.

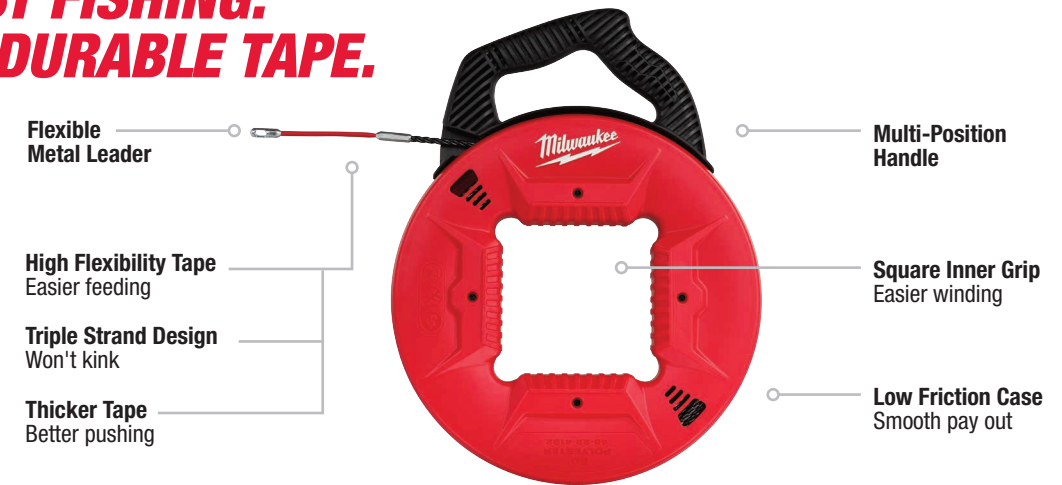

Also Available:



50ft Polyester Fish Tape with Nonconductive Tip
48-22-4162



High Flexibility Tape

Model #	Description
48-22-4192	50ft Polyester Fish Tape with Flexible Metal Leader
48-22-4195	100ft Polyester Fish Tape with Flexible Metal Leader
48-22-4197	200ft Polyester Fish Tape with Flexible Metal Leader
48-22-4162	50ft Polyester Fish Tape with Nonconductive Tip
48-22-4165	100ft Polyester Fish Tape with Nonconductive Tip
48-22-4167	200ft Polyester Fish Tape with Nonconductive Tip

STEEL FISH TAPES

SMOOTH PAYOUT.
EASIER FISHING.

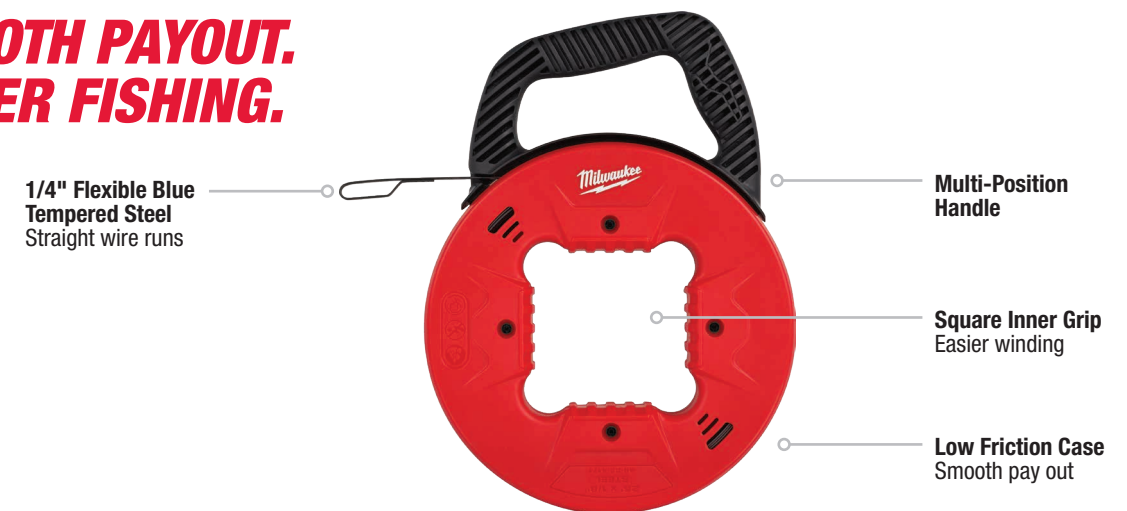

Laser Etched Markings

Model #	Description
48-22-4171	25ft 1/8" Steel Fish Tape
48-22-4172	50ft 1/8" Steel Fish Tape
48-22-4173	60ft 1/8" Steel Fish Tape
48-22-4176	120ft 1/8" Steel Fish Tape
48-22-4178	240ft 1/8" Steel Fish Tape
48-22-4181	25ft 1/4" Steel Fish Tape with Low Profile Tip
48-22-4185	100ft 1/4" Steel Fish Tape



PACKOUT™

MOST VERSATILE DURABLE MODULAR STORAGE SYSTEM



FULLY
CUSTOMIZE
YOUR STORAGE™



IMPACT
RESISTANT™



IP65
RATED
PROTECTION™



BUILD
YOUR SYSTEM



ROLLING TOOL BOX



250 LBS
CAPACITY™



IMPACT
RESISTANT
BODY™



9" ALL-
TERRAIN
WHEELS™

Modular Connectivity
with All PACKOUT™
Components

Metal Reinforced
Locking Point

IP65 Rated
Protection



Industrial-Grade
Extension Handle

Interior
Organization
Tray

Metal Reinforced
Corners

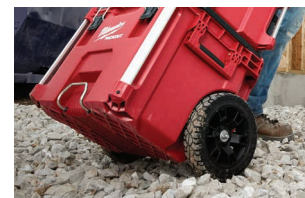

9" All-Terrain Wheels

Model #	Description	Weight Capacity
48-22-8426	PACKOUT™ Rolling Tool Box	250 lbs

TOOL BOXES



IMPACT
RESISTANT
BODY™



IP65
RATED
PROTECTION™



METAL-
REINFORCED
CORNERS™

Metal Reinforced
Locking Point

IP65 Rated
Protection



Also Available:



PACKOUT™ Tool Box
48-22-8424

Modular Connectivity
with All PACKOUT™
Components
Metal Reinforced
Corners



Interior Organizer Trays

Model #	Description	Weight Capacity
48-22-8424	PACKOUT™ Tool Box	75 lbs
48-22-8425	PACKOUT™ Large Tool Box	100 lbs

TOOL CASE WITH CUSTOMIZABLE INSERT



IMPACT
RESISTANT
BODY™



IP65
RATED
PROTECTION™



CUSTOMIZE
YOUR INSERT™

75lbs Weight
Capacity

Impact Resistant
Polymer Construction

Reinforced
Locking Point



IP65 Rated
Protection

Modular Connectivity
with All PACKOUT™
Components

Also Available:



PACKOUT™
Customizable
Foam Insert
48-22-8451



Customizable Foam Insert

Model #	Description	Weight Capacity
48-22-8450	PACKOUT™ Tool Case with Customizable Insert	75 lbs
48-22-8451	PACKOUT™ Customizable Foam Insert	



PACKOUT™ MODULAR STORAGE

CRATE



STACK OR HANG™



IMPACT RESISTANT BODY™



50 LBS CAPACITY™

50 lbs Weight Capacity

Stack or Hang

- Rear hanging points for vertical use
- Top attachment points for stacking



Modular Connectivity with All PACKOUT™ Components

Impact Resistant Polymer Construction



Stack or Hang

Model #	Description
48-22-8440	PACKOUT™ Crate

ORGANIZERS



IMPACT RESISTANT BODY™



IP65 RATED PROTECTION™



NO-TRAVEL BIN SEALS™

Removable & Mountable Bins

No-Travel Bin Seals

IP65 Rated Protection

Modular Connectivity with All PACKOUT™ Components

Impact Resistant Polymer Base

Also Available:



PACKOUT™ Compact Organizer
48-22-8435



Removable & Mountable Bins

Model #	Description
48-22-8430	PACKOUT™ Organizer
48-22-8435	PACKOUT™ Compact Organizer

LOW-PROFILE ORGANIZERS



IMPACT RESISTANT BODY™



IP65 RATED PROTECTION™



NO-TRAVEL BIN SEALS™

6 Removable Bin Dividers

5 Removable Bins

No-Travel Bin Seals

IP65 Rated Protection

Modular Connectivity with All PACKOUT™ Components

Impact Resistant Polymer Base
Low-Profile Design

Also Available:



PACKOUT™ Low-Profile Organizer
48-22-8431



Removable Bins

Model #	Description
48-22-8431	PACKOUT™ Low-Profile Organizer
48-22-8436	PACKOUT™ Low-Profile Compact Organizer



PACKOUT™ MODULAR STORAGE

TOTES



TEAR-RESISTANT MATERIAL™



IMPACT RESISTANT BASE™



ALL-METAL HARDWARE™

Durable Overmold Handle

All-Metal Hardware

Padded Removable Shoulder Strap

Tear-Resistant 1680D Ballistic Material

Modular Connectivity with All PACKOUT™ Components

Impact Resistant Polymer Base

Also Available:



PACKOUT™ 10" Tote
48-22-8310



PACKOUT™ 15" Tote
48-22-8315



Optimized Storage Capacity

Model #	Description	Tool Pockets
48-22-8310	PACKOUT™ 10" Tote	28
48-22-8315	PACKOUT™ 15" Tote	31
48-22-8320	PACKOUT™ 20" Tote	32

TOOL BAGS



TEAR-RESISTANT MATERIAL™



IMPACT RESISTANT BASE™



ALL-METAL HARDWARE™

Versatile Carry
Cushioned shoulder strap,
top handles, side handles

Also Available:



PACKOUT™ 15" Tool Bag
48-22-8321

Spacious Storage Compartment

Tear-Resistant 1680D Ballistic Material

Modular Connectivity with All PACKOUT™ Components

All-Metal Hardware

Impact Resistant Polymer Base



Spacious Storage Compartment

Model #	Description
48-22-8321	PACKOUT™ 15" Tool Bag
48-22-8322	PACKOUT™ 20" Tool Bag

COOLER



HOLDS ICE FOR 24 HRS™



ALL-METAL HARDWARE™



IMPACT RESISTANT BASE™

Food-Grade Leak Proof Liner

All-Metal Hardware

No Sweat Exterior

Tape Measure Clip with Bottle Opener

Tear-Resistant Ballistic Material

Impact Resistant Polymer Base

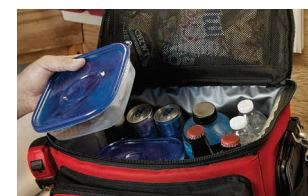

Holds Ice for 24 Hours

Model #	Description
48-22-8302	PACKOUT™ Cooler

PACKOUT™ BACKPACK

- TEAR-RESISTANT MATERIAL™**
- IMPACT RESISTANT BASE™**
- OPTIMIZED STORAGE CAPACITY™**



Optimized Storage Capacity

Model #	Description	Tool Pockets
48-22-8301	PACKOUT™ Backpack	48

PACKOUT™ TECH BAG

- TEAR-RESISTANT MATERIAL™**
- IMPACT RESISTANT BASE™**
- OPTIMIZED STORAGE CAPACITY™**



Optimized Storage Capacity

Model #	Description	Tool Pockets
48-22-8300	PACKOUT™ Tech Bag	58

MOUNTING PLATE

- WALL & FLOOR MOUNTING™**
- 50 LBS WALL MOUNTED CAPACITY™**
- METAL-REINFORCED MOUNTING POINTS™**

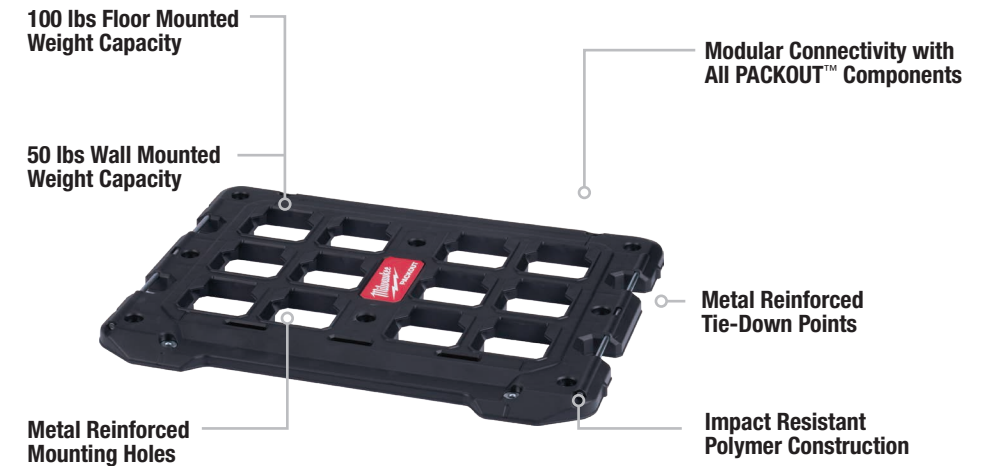

Wall & Floor Mounting

Model #	Description
48-22-8485	PACKOUT™ Mounting Plate

DOLLY

- 250 LBS CAPACITY™**
- QUICKSTOP LOADING LEVER™**
- SMOOTH ROLL WHEELS™**



QUICKSTOP™ Loading Lever

Model #	Description
48-22-8410	PACKOUT™ Dolly

JOBSITE TECH BAG

UP TO **5X MORE DURABLE**



Model #	Description
48-22-8210	Jobsite Tech Bag

HARDTOP™ ROLLING BAGS

MOST DURABLE. ULTIMATE VERSATILITY.

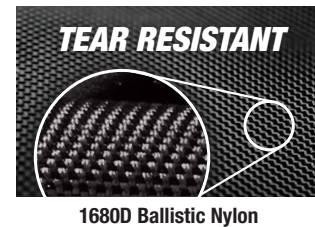

Model #	Description
48-22-8221	18" Rolling Bag
48-22-8220	24" HARDTOP™ Rolling Bag

JOBSITE COOLER

HOLDS ICE UP TO **24HRS**



Model #	Description
48-22-8250	Jobsite Cooler

LOW-PROFILE BACKPACK

DURABLE, LOW-PROFILE DESIGN



Model #	Description	Pockets
48-22-8202	Low-Profile Backpack	22

JOBSITE BACKPACK

UP TO **5X MORE DURABLE**



Impact-Resistant Base

Model #	Description	Pockets
48-22-8200	Jobsite Backpack	35

ULTIMATE JOBSITE BACKPACK

ULTIMATE DURABILITY, PROTECTION, & STORAGE



Impact-Resistant Base

Model #	Description	Pockets
48-22-8201	Ultimate Jobsite Backpack	48

PARACHUTE ORGANIZER BAG

FASTEST ACCESS, BEST CONSTRUCTION



Stand-Up & Stay-Open Design

Model #	Description
48-22-8170	Parachute Organizer Bag

BUCKET ORGANIZER WRAP

MOST VERSATILE BUCKET ORGANIZER



Exterior Zipper Pockets

Model #	Description
48-22-8175	Bucket Organizer Wrap

ZIPPER POUCHES

UP TO **2X MORE DURABLE**



Water Resistant Stand-Up Base

Model #	Description
48-22-8180	Zipper Pouch
48-22-8193	3 Pc Zipper Pouches
48-22-8183	3 Pc Multi-Size Zipper Pouches

JOBSITE ORGANIZER

**MOST VERSATILE
JOBSITE ORGANIZER**

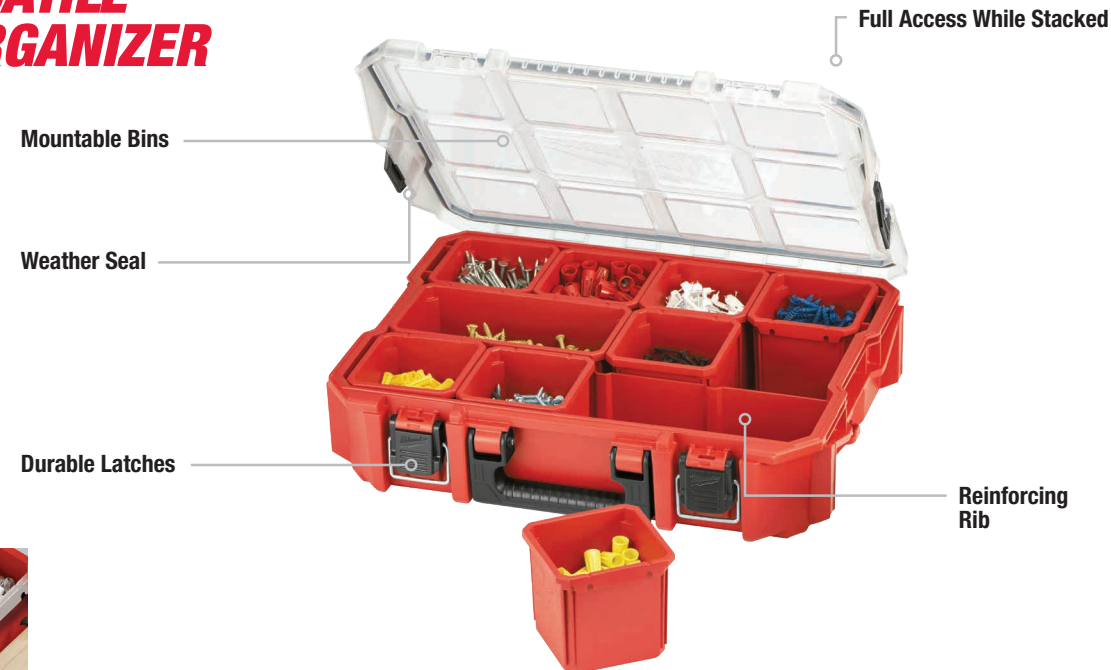

No-Travel Bin Seals

Model #	Description
48-22-8030	20" Jobsite Organizer

WORK BELTS & POUCHES

UP TO **5X LONGER LIFE**

Contractor's Work Belt with Suspension Rig
48-22-8120



Model #	Description
48-22-8100	Electrician's Work Belt with Quick-Adjust Belt
48-22-8110	Electrician's Work Belt
48-22-8111	Compact Electrician's Work Pouch
48-22-8120	Contractor's Work Belt with Suspension Rig
48-22-8121	Carpenter's Work Pouch
48-22-8122	3-Tier Material Work Pouch

Electrician's Work Belt
48-22-8110

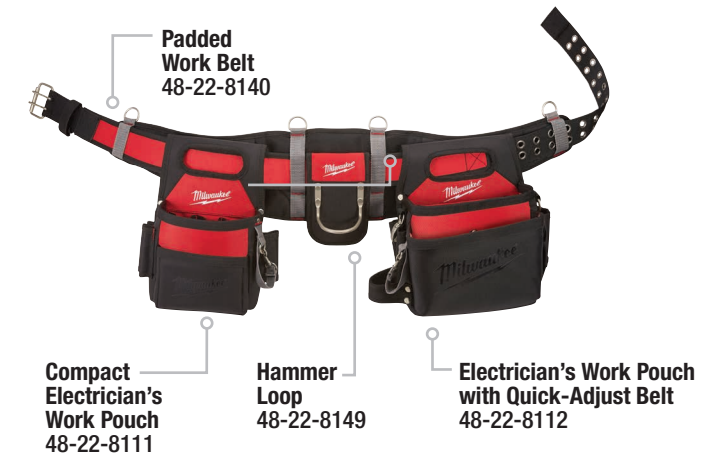

Model #	Description
48-22-8140	Padded Work Belt
48-22-8145	Padded Rig
48-22-8146	XL Padded Rig
48-22-8149	Hammer Loop
48-22-8112	Electrician's Work Pouch with Quick-Adjust Belt

COMPACT UTILITY POUCH

UP TO **5X LONGER LIFE**



Quick-Attach Belt Loop

Model #	Description
48-22-8118	Compact Utility Pouch

UTILITY POUCH



Quick-Attach Belt Loop

Model #	Description
48-22-8119	Utility Pouch

AERIAL TOOL APRON

**REDEFINED PERFORMANCE.
LASTING DURABILITY.**



Dedicated Flood Light

Model #	Description
48-22-8290	Aerial Tool Apron

UNDERGROUND OVAL BAG

UP TO 5X MORE DURABLE



Puncture Resistant Pockets

Model #	Description
48-22-8275	Underground Oval Bag

AERIAL OVAL BAG

UP TO 5X MORE DURABLE



Puncture Resistant Pockets

Model #	Description
48-22-8276	Aerial Oval Bag

CANVAS UTILITY BUCKET

**REINFORCED CANVAS.
LASTING DURABILITY.**



Double Layered Canvas Construction

Model #	Description
48-22-8270	Canvas Utility Bucket

DEMOLITION GLOVES WITH SMARTSWIPE™

UP TO **5X LONGER LIFE**



Touch Screen Compatible Knuckle

Model #	Description
48-22-8735	Demolition Gloves S
48-22-8731	Demolition Gloves M
48-22-8732	Demolition Gloves L

Model #	Description
48-22-8733	Demolition Gloves XL
48-22-8734	Demolition Gloves XXL

PERFORMANCE GLOVES WITH SMARTSWIPE™

**ULTIMATE DURABILITY.
ALL DAY COMFORT.**



Touch Screen Compatible Fingertips, Palm & Knuckle

Model #	Description
48-22-8725	Performance Gloves S
48-22-8721	Performance Gloves M
48-22-8722	Performance Gloves L
48-22-8723	Performance Gloves XL
48-22-8724	Performance Gloves XXL

Model #	Description
48-22-8745	Performance Fingerless Gloves S
48-22-8741	Performance Fingerless Gloves M
48-22-8742	Performance Fingerless Gloves L
48-22-8743	Performance Fingerless Gloves XL
48-22-8744	Performance Fingerless Gloves XXL

FREE-FLEX GLOVES WITH SMARTSWIPE™

**ULTIMATE DURABILITY.
ALL DAY COMFORT.**



Touch Screen Compatible Fingertips, Palm & Knuckle

Model #	Description
48-22-8715	Free-Flex Gloves S
48-22-8711	Free-Flex Gloves M
48-22-8712	Free-Flex Gloves L

Model #	Description
48-22-8713	Free-Flex Gloves XL
48-22-8714	Free-Flex Gloves XXL

CUT LEVEL 1 DIPPED GLOVES WITH SMARTSWIPE™

**ULTIMATE DURABILITY.
ALL DAY COMFORT.**

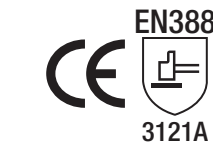

Size	1 Pair	12 Pair (Contractor Pack)
S	48-22-8900	48-22-8900B
M	48-22-8901	48-22-8901B
L	48-22-8902	48-22-8902B



Size	1 Pair	12 Pair (Contractor Pack)
XL	48-22-8903	48-22-8903B
XXL	48-22-8904	48-22-8904B

CUT LEVEL 3 DIPPED GLOVES WITH SMARTSWIPE™

**ULTIMATE DURABILITY.
ALL DAY COMFORT.**



Size	1 Pair	12 Pair (Contractor Pack)
S	48-22-8930	48-22-8930B
M	48-22-8931	48-22-8931B
L	48-22-8932	48-22-8932B



Size	1 Pair	12 Pair (Contractor Pack)
XL	48-22-8933	48-22-8933B
XXL	48-22-8934	48-22-8934B

CUT LEVEL 5 DIPPED GLOVES WITH SMARTSWIPE™

**ULTIMATE DURABILITY.
ALL DAY COMFORT.**



Size	1 Pair	12 Pair (Contractor Pack)
S	48-22-8950	48-22-8950B
M	48-22-8951	48-22-8951B
L	48-22-8952	48-22-8952B



Size	1 Pair	12 Pair (Contractor Pack)
XL	48-22-8953	48-22-8953B
XXL	48-22-8954	48-22-8954

CUT LEVEL 1 INSULATED WINTER GLOVES

**ULTIMATE WARMTH.
ALL DAY COMFORT.**

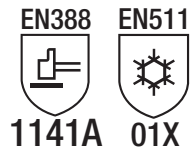

Size	1 Pair	12 Pair (Contractor Pack)
S	48-22-8910	48-22-8910B
M	48-22-8911	48-22-8911B
L	48-22-8912	48-22-8912B

Size	1 Pair	12 Pair (Contractor Pack)
XL	48-22-8913	48-22-8913B
XXL	48-22-8914	48-22-8914B

CUT LEVEL 3 INSULATED WINTER GLOVES

**ULTIMATE WARMTH.
ALL DAY COMFORT.**

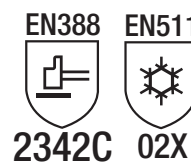

Size	1 Pair	12 Pair (Contractor Pack)
S	48-22-8920	48-22-8920B
M	48-22-8921	48-22-8921B
L	48-22-8922	48-22-8922B

Size	1 Pair	12 Pair (Contractor Pack)
XL	48-22-8923	48-22-8923B
XXL	48-22-8924	48-22-8924B

LOCKING TOOL LANYARDS

**BEST SHOCK
ABSORPTION**



Tether Tools When Working at Height

Double-Locking Carabiner

Part #	Weight Rating	Description
48-22-8810	10 lbs	Locking Tool Lanyard
48-22-8811	10 lbs	10 lbs Extended Reach Locking Tool Lanyard
48-22-8815	15 lbs	15 lbs Locking Tool Lanyard
48-22-8850	35 lbs	35 lbs Locking Tool Lanyard

QUICK-CONNECT LOCKING TOOL LANYARD SYSTEM

**BEST SHOCK
ABSORPTION**

**QUICK-CONNECT
LANYARD SYSTEM**

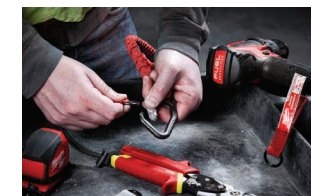

Quick Tool Change Out

Part #	Weight Rating	Description
48-22-8820	10 lbs	10 lbs Quick-Connect Locking Tool Lanyard
48-22-8822	5 lbs	3 Pc 5 lbs Quick-Connect Lanyard Accessory
48-22-8823	10 lbs	3 Pc 10 lbs Quick-Connect Lanyard Accessory

TAPE & D-RING WEB ATTACHMENTS

EASILY CONNECT



48-22-8860



48-22-8870



48-22-8871



48-22-8872



Part #	Weight Rating	Description
48-22-8860		12' Self-Adhering Tape
48-22-8870	2 lbs	5 Pc 2 lbs D-Ring Web Attachment
48-22-8871	5 lbs	5 Pc 5 lbs D-Ring Web Attachment
48-22-8872	35 lbs	D-Ring 35 lbs Web Attachment

SPLIT RINGS

EASILY CONNECT

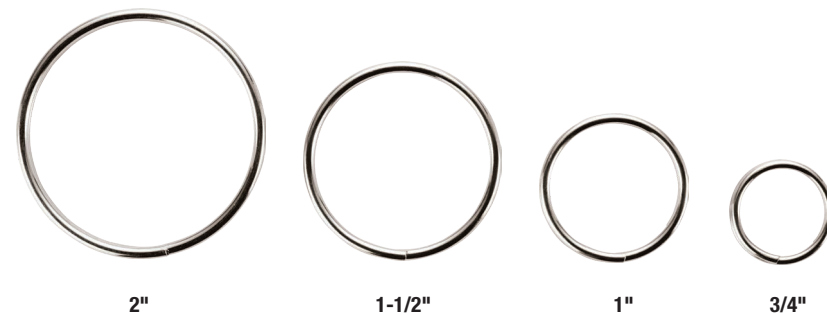

2"

1-1/2"

1"

3/4"

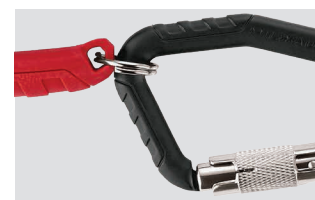

Part #	Weight Rating	Description
48-22-8880	2 lbs	5 Pc 2 lbs 3/4" Split Ring
48-22-8881	2 lbs	5 Pc 2 lbs 1" Split Ring
48-22-8882	2 lbs	5 Pc 2 lbs 1-1/2" Split Ring
48-22-8883	2 lbs	5 Pc 2 lbs 2" Split Ring

- 2 TAPE MEASURES
- 4 LONG TAPES & MEASURING WHEELS
- 5 REDSTICK™ LEVELS
- 7 REDSTICK™ CONCRETE LEVELS & TORPEDO LEVELS
- 8 SQUARES & LASER DISTANCE METERS
- 9 FOLDING RULERS & CHALK REELS
- 10 INKZALL™ JOBSITE MARKERS
- 11 INKZALL™ PAINT MARKERS, PENS & HIGHLIGHTERS
- 12 FASTENING PLIERS
- 13 FASTENING & CUTTING PLIERS
- 14 CUTTING PLIERS
- 15 COMBINATION & MULTI-FUNCTION PLIERS
- 16 APPLICATION SPECIFIC PLIERS
- 17 TORQUE LOCK™ PLIERS, C-CLAMPS & SPECIALTY
- 18 PIPE WRENCHES
- 20 ADJUSTABLE & BASIN WRENCHES
- 21 RATCHET & SOCKET SETS
- 22 COMBINATION WRENCHES & PRY BARS
- 23 HOOK AND PICK SET & MULTI-BIT DRIVERS
- 24 MULTI-BIT DRIVERS & SCREWDRIVERS
- 25 SCREWDRIVERS
- 27 NUT DRIVERS
- 28 HAMMERS & POCKET KNIVES
- 29 FIXED BLADE & POCKET KNIVES
- 30 POCKET KNIVES
- 31 UTILITY KNIVES
- 34 INSULATION & DUCT KNIVES
- 35 AVIATION SNIPS
- 36 TINNER SNIPS
- 37 SCISSORS, SEAMER & CRIMPER
- 38 BOLT CUTTERS
- 39 HACKSAWS
- 40 SAWS
- 41 TUBING/PIPE CUTTERS & REAMING PEN
- 42 COPPER TUBING CUTTERS
- 44 LOW VOLTAGE VDV
- 46 CONDUIT BENDERS
- 47 FISH TAPES
- 48 PACKOUT™ MODULAR STORAGE
- 54 BAGS
- 55 COOLERS & BACKPACKS
- 56 BACKPACKS
- 57 ORGANIZERS
- 59 WORK BELTS & POUCHES
- 60 POWER UTILITY STORAGE
- 62 WORK GLOVES
- 63 DIPPED GLOVES
- 64 INSULATED WINTER GLOVES
- 65 LANYARD ACCESSORIES



MILWAUKEE TOOL
13135 West Lisbon Road
Brookfield, WI 53005

milwaukeetool.com

