

CONNECTIONS

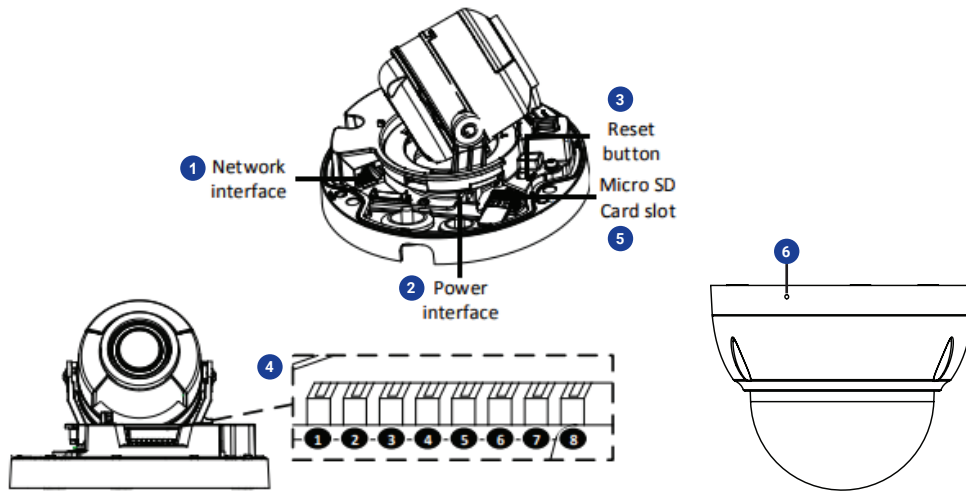

1	RJ-45	-	For network and PoE connections
2	Power (12vDC)	1	12vDC +
		2	GND -
		Power Connection	
3	Reset Button	-	To restore the camera to factory defaults: 1. Disconnect power for 30 seconds. 2. Reconnect power and wait 30 seconds. 3. Press and hold the reset button for 20 seconds.
4	Alarm & Audio I / O	1	Alarm Out -
		2	Alarm Out +
		Alarm connection	
		3	GND
		Ground connection	
		4	Alarm In
		Alarm connection	
5	GND		
Ground connection			
6	Audio In	Two-way audio transmission	
7	GND	Ground Connection	
8	Audio Out	Two-way audio transmission	
5	microSD Card Slot	-	Supports up to 512GB microSD card for Edge storage. Do not add or remove the microSD card when the camera is powered on.
6	Built-in microphone		

This quick start guide provides only basic information on the camera's settings and operation for initial installation. Please read the user manual for optimal camera configurations.

Find the latest product documentation and software.



Scan the QR code or go to openeye.net/downloads



QUICK START GUIDE

4MP Indoor IP Dome
OE-C3011D4-S

CONTENTS

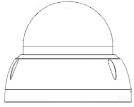

OE-C3011D4-S
Mini Dome Camera

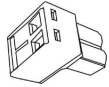

2-Pin Terminal
Power Block



Self-Tapping
Screws &
Plastic Anchors

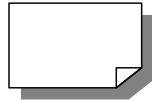

Quick Start
Guide

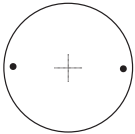

Mounting Template



Tapered RJ45 Sleeve

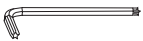

Security Torx Tool

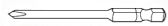

#2 Phillips Bit



2x - 21mm Cable
Grommet



2x - 28mm Cable
Grommet

Optional Free Paintable Dome Cover

This camera has an available paintable dome cover allowing it to be quickly converted to a black housing or the allow custom painting to match its installation environment. To reduce waste it is not included in every package but may be requested free of charge at time of purchase.

DEFAULT USERNAME AND PASSWORD

NOTE: OpenEye IP cameras ship without a default password.

The admin user password can be set using the following methods:

1. OpenEye recorders running Apex 2.6 or newer will automatically set a new unique password when added in setup, if a new password has not already been set.

Set the Default Camera Password

Use the QR code or link for instructions on defining a unique camera password:
https://answers.openeye.net/Install/Adding_Cameras_and_Camera_Settings/Default_Camera_Password



2. Connect to the camera directly through a Web Browser and follow the onscreen prompts.
3. Use the Network Camera Manager (NCM) Utility.

Username: `admin`

ASSIGNING AN IP ADDRESS

OpenEye IP cameras are set to DHCP by default. If a DHCP server is not detected after 4 minutes, the camera will default to IP address 192.168.51.2. If you are not using a DHCP server, NCM will allow you to batch configure a static IP address.

The IP address for the camera network on your Apex recorder is 192.168.51.1.

NOTE: To change this IP address please refer to your Apex recorder manual.

Selecting multiple cameras and entering IP address 192.168.51.2 will set an IP address on all selected cameras, starting at 192.168.51.2 and increase per camera.

1. Open the Network Camera Manager application.
2. Select applicable camera(s).
3. Input starting IP address, Subnet Mask, Gateway, DNS.
4. Apply changes.
5. Wait 60 seconds before refreshing NCM.

NOTE: The NCM software manual can be found at https://answers.openeye.net/Install/Adding_Cameras_and_Camera_Settings/Network_Camera_Manager

CONNECTING TO THE IP CAMERA

To access the camera setup menu, you need to open Network Camera Manager (NCM) utility. NCM is pre-installed on all OpenEye Recorders, and is also available for download on the OpenEye website for installation on your personal computer or laptop.

1. Open Network Camera Manager.
2. Locate your camera on the Network Camera Manager list.
3. To open the web browser, select the camera and click LOAD.

CABLING INSTRUCTIONS

1. Push the RJ45 connector into the tapered sleeve.
2. Cut the end off the center of the cable grommet and feed the network cable through the opening.
3. Remove the tapered sleeve.
4. Insert the RJ45 connector into the network port. Pull the cable downward to make sure the cable grommet protrudes to the direction opposite to the RJ45 connector.

