

OpenEye[®]

The Cloud Video Platform

4MP OUTDOOR IP TURRET

OE-C3012T4-S
USER MANUAL



OE- C3012T4-S 4MP Outdoor IP Turret Camera
User Manual

Manual Edition 37822AB – December 2022

©2022, OPENEYE
All Rights Reserved.

No part of this documentation may be reproduced in any means, electronic or mechanical, for any purpose, except as expressed in the Software License Agreement. OpenEye shall not be liable for technical or editorial errors or omissions contained herein. The information in this document is subject to change without notice.

The information in this publication is provided “as is” without warranty of any kind. The entire risk arising out of the use of this information remains with recipient. In no event shall OPENEYE be liable for any direct, consequential, incidental, special, punitive, or other damages whatsoever (including without limitation, damages for loss of business profits, business interruption or loss of business information), even if OPENEYE has been advised of the possibility of such damages and whether in an action or contract or tort, including negligence.

This documentation is copyrighted. All other rights are reserved to OPENEYE. OPENEYE, and OpenEye, are registered trademarks of OPENEYE in the United States and elsewhere; Windows, and Windows XP Embedded are registered trademarks of Microsoft Corporation. All other brand and product names are trademarks or registered trademarks of the respective owners.

OPENEYE
Liberty Lake, WA • U.S.A.

Important Safeguards

Read Instructions

Read all of the safety and operating instructions before using the product.

Retain Instructions

Save these instructions for future reference.

Attachments / Accessories

Do not use attachments or accessories unless recommended by the appliance manufacturer as they may cause hazards, damage product and void warranty.

Installation

Do not place or mount this product in or on an unstable or improperly supported location. Improperly installed product may fall, causing serious injury to a child or adult, and damage to the product. Use only with a mounting device recommended by the manufacturer or sold with the product. To insure proper mounting, follow the manufacturer's instructions and use only mounting accessories recommended by manufacturer.

Power source

This product should be operated only from the type of power source indicated on the marking label.

Precautions

Operating

Before using, make sure power supply and others are properly connected.

While operating, if any abnormal condition or malfunction is observed, stop using the camera immediately and then contact your local dealer.

Handling

Do not disassemble or tamper with parts inside the camera.

Do not drop or subject the camera to shock and vibration as this can damage camera.

Care must be taken when you clean the clear dome cover. Scratches and dust will ruin the image quality of your camera. Do not use strong or abrasive detergents when cleaning the camera body. Use a dry cloth to clean the camera when it is dirty. In case the dirt is hard to remove, use a mild detergent and wipe the camera gently.

Installation and Storage

Do not install the camera in areas of extreme temperatures in excess of the allowable range; install the camera in areas with temperatures within the camera's operating temperature, including the following: -22° ~ 140°F (-30° ~ 60°C)

Avoid installing in humid or dusty places. The relative humidity must be below 95%.

Avoid installing in places where radiation is present.

Avoid installing in places where there are strong magnetic fields and electric signals.

Avoid installing in places where the camera would be subject to strong vibrations.

Never face the camera toward the sun. Do not aim at bright objects. Whether the camera is in use or not, never aim it at the sun or other extremely bright objects. Otherwise the camera may be smeared and damaged.

Cleaning

If the video image becomes blurry or smudged in areas, it may be because the lens cover requires cleaning.

To clean the lens cover:

- Use hand soap or a non-abrasive detergent to wash off dirt or fingerprints.
- Use a microfiber cloth or non-abrasive fabric to dry the dome bubble.
 - **Important:** Failure to use the recommended cleaning materials may result in a damaged or scratched lens cover. A damaged lens cover may negatively impact image quality and cause unwanted IR light reflecting into the lens.

To clean the camera body:

- Use a dry or lightly dampened cloth to clean the camera body.
- Do not use strong or abrasive detergents.

Regulation

This device complies with Part 15 of the FCC Rules. Operation is subject to the following two conditions: (1) this device may not cause harmful interference, and (2) this device must accept any interference received, including interference that may cause undesired operation.

Compliance is evidenced by written declaration from our suppliers, assuring that any potential trace contamination levels of restricted substances are below the maximum level set by EU Directive 2002/95/EC, or are exempted due to their application.

Warning

DANGEROUS HIGH VOLTAGES ARE PRESENT INSIDE THE ENCLOSURE.
DO NOT OPEN THE CABINET.
REFER SERVICING TO QUALIFIED PERSONNEL ONLY.

Caution

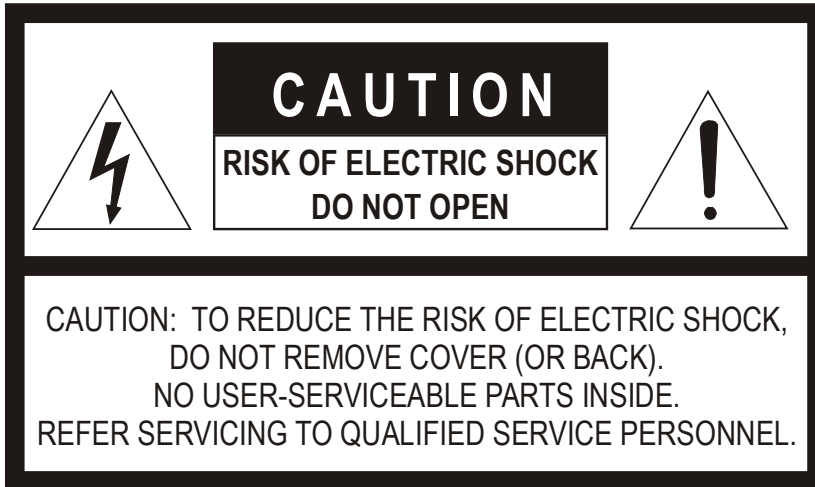

Table of Contents

Introduction	8
Overview	8
Product Features	8
Getting Started	9
Box Contents	9
Camera Overview	10
Camera Dimensions	10
Connections	10
Power Connection.....	11
NETWORK CAMERA MANAGER	12
Launching Network Camera Manager.....	12
Finding Network Devices.....	12
Username and Password	13
Live View	13
Setup & Configuration.....	15
Basic Camera Settings	15
Basic Information.....	15
Network Settings	16
Network	16
DNS	16
Port.....	17
DDNS.....	18
FTP.....	19
Email	22
Streaming Settings	23
Video	23
Stream URLs / RTSP	24
Snapshot.....	25
Audio.....	26
Region of Interest (ROI)	27
Media Stream	28
Picture Settings.....	29
Image	29
On-Screen Display	33
Privacy Mask	34
Analytics.....	35
Intrusion Detection.....	35
Line Crossing Detection.....	38
Event Settings	41
Alarms.....	41
Storage Settings	44
Storage	44
Snapshot Download.....	45
Recording Download.....	45
Security Settings	46

User	46
Network Security	47
Watermark	48
Maintenance	48
Time	48
Maintenance.....	49
Log	51

Introduction

OVERVIEW

The OE-C3012T4-S is a 4MP outdoor IP turret camera equipped with person, vehicle, and line crossing detection analytics. The 2.7~13.5mm varifocal, autofocus, motorized zoom lens, and true WDR functionality combine with real-time event notifications provide actionable, high-definition video. Adaptive IR technology prevents overexposure of objects close to the camera further enhancing the low light performance.

Smart Compression reduces network throughput and storage requirements without impacting video quality. Capable of operating in temperatures as low as -22°F, and as high as 140°F, with an IP67 weather rating, this camera is well-suited for harsh environments.

The OE-C3012T4 is ONVIF™ profile S/G/T compliant and fully compatible with the OpenEye Web Services (OWS) platform, allowing multiple users to concurrently view high quality images and perform remote setup using a Web browser.

PRODUCT FEATURES

- Person, Vehicle, Line Crossing Detection Analytics
- Low Maintenance
- NDAA Compliant
- Corridor Mode
- True WDR @ 4MP
- Adaptive IR – up to 131'
- 2.7 ~ 13.5mm VF, AF, Zoom Lens
- 4MP Resolution | Up to 30 FPS
- IK10 Impact Protection Rating
- IP67 Ingress Protection Rating
- Smart Compression
- Built-in microphone

Getting Started

BOX CONTENTS

Before proceeding, please confirm that the box contains the items listed here. Please contact your dealer for assistance if any item is missing or has defects.

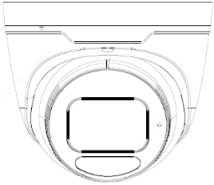
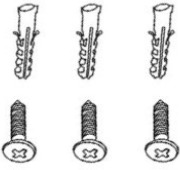
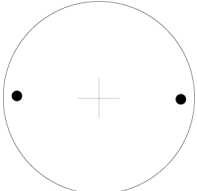
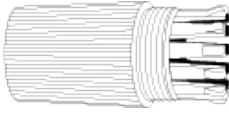
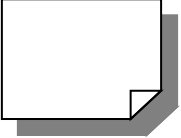
 <p>OE-C3012T4-S Turret Camera</p>	 <p>Self-tapping screws and Plastic Anchors x 3</p>
 <p>Mounting Template</p>	 <p>Waterproof Cable Connector</p>
 <p>Quick Start Guide</p>	

CAMERA OVERVIEW

CAMERA DIMENSIONS

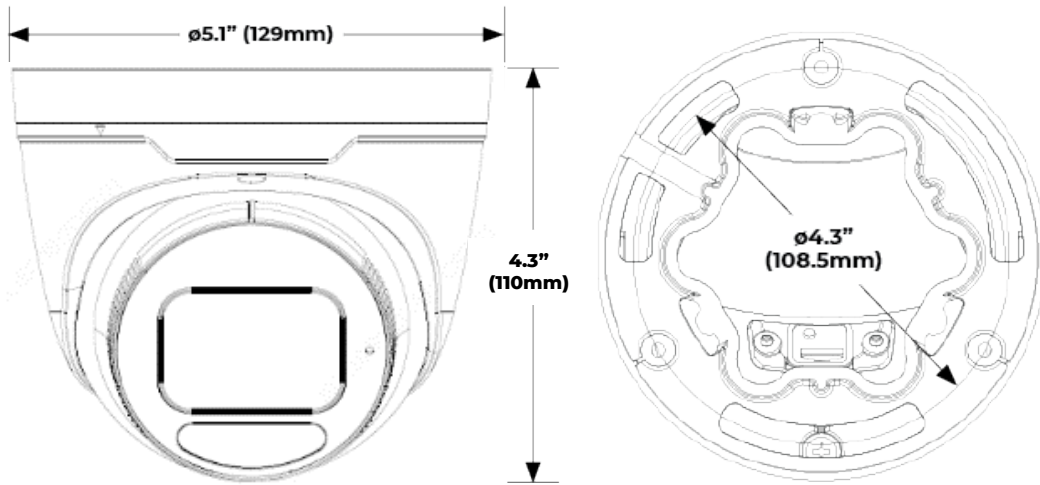

CONNECTIONS

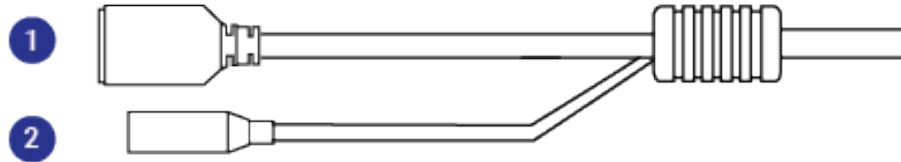

1	RJ45	For connector and PoE connections
2	Power (12vDC)	Power connection

POWER CONNECTION

For an adequate power connection, use a 12vDC adaptor. Alternatively, you can power the camera by PoE if a Power Sourcing Equipment (PSE) switch is available. Ensure that the camera's power cable is correctly and firmly connected.



Note OpenEye recommends against using more than one power source at a time. Do not use a PoE power source when providing the camera with 12vDC power.

If using Power over Ethernet (PoE), make sure Power Sourcing Equipment (PSE) is in use in the network.

NETWORK CAMERA MANAGER

OpenEye Network Camera Manager (NCM) is a software tool that allows you to quickly and easily connect and configure your OpenEye IP Cameras. This software allows you to apply the camera password, assign IP addresses, configure video settings, and update firmware on multiple cameras at once.

NCM is pre-installed on all OpenEye Recorders and is also available for download www.OpenEye.net for installation on your personal computer or laptop. Network Camera Manager is a Java application, this allows it to be installed on Windows and Linux operating systems.

LAUNCHING NETWORK CAMERA MANAGER

Apex Windows Platforms

Network Camera Manager can be found on the desktop.

Linux Platforms

In the Apex Settings menu, go to the **Cameras** page and click **Advanced**.

FINDING NETWORK DEVICES

Click **Refresh** to reload the Device List.

To narrow your search by **Camera Model** or **Network**, use the **Model Filter** and **Networks** dropdowns.

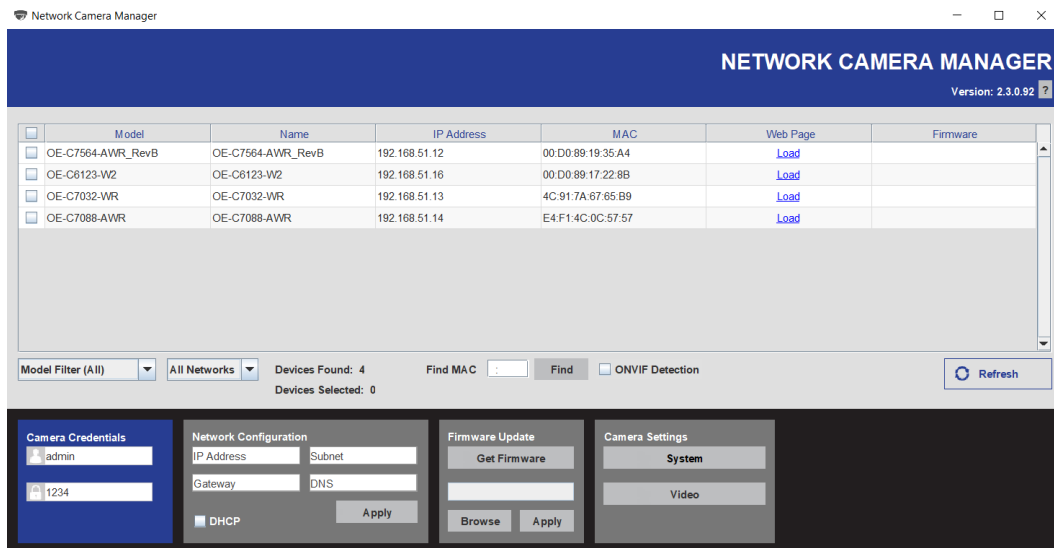

Model	Name	IP Address	MAC	Web Page	Firmware
OE-C7564-AWR_RevB	OE-C7564-AWR_RevB	192.168.51.12	00:D0:89:19:35:A4	Load	
OE-C6123-W2	OE-C6123-W2	192.168.51.16	00:D0:89:17:22:8B	Load	
OE-C7032-WR	OE-C7032-WR	192.168.51.13	4C:91:7A:67:65:B9	Load	
OE-C7088-AWR	OE-C7088-AWR	192.168.51.14	E4:F1:4C:0C:57:57	Load	

A Mac Address search is also available if you are looking for a specific device.

USERNAME AND PASSWORD

**OpenEye IP cameras ship without a default password.*

Username: **admin**

The **admin** user password can be set using the following methods:

1. OpenEye recorders running Apex 2.6 or newer will automatically set a new unique password when added in setup, if a new password has not already been set.

Note	You can set your Default Camera Password under the General Settings page within <i>Setup > System Settings > General Settings</i> . For instructions on defining your unique camera password, visit: https://www.openeye.net/support/faqs/default-camera-password
-------------	---

2. Connect to the camera directly through a Web Browser and follow the onscreen prompts.
3. Use the Network Camera Manager (NCM) Utility.

Note	The NCM Software Manual can be found at Network Camera Manager
-------------	--

Note	Refer to your Apex recorder manual or quick start guide for instruction on adding cameras.
-------------	--

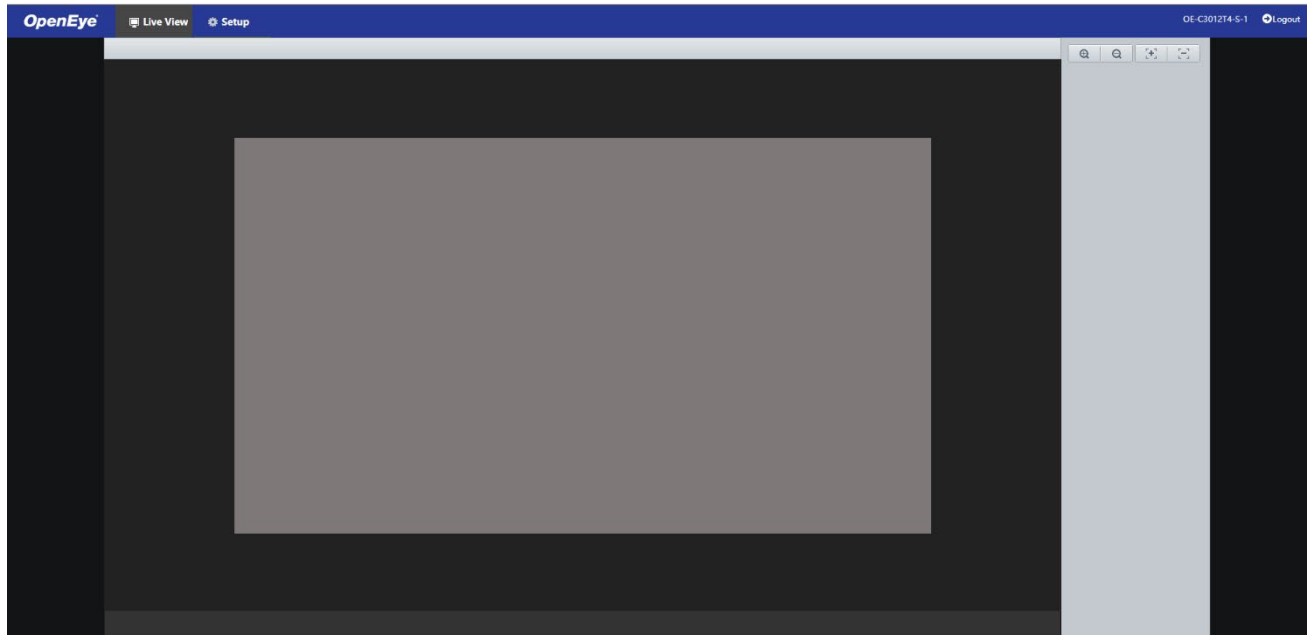

Live View



The camera displays a live view using the MJPEG stream for setup purposes.

Setup – Go to the Setup tab to access the camera menus

Logout – Log out the current user

Zoom In / Out   – Adjust camera zoom in or out

Focus +/-   – Adjust camera focus

SETUP & CONFIGURATION

BASIC CAMERA SETTINGS

Basic Information

The Basic Information tab displays the product model, firmware, network, and MAC address for the connected camera, along with the current camera Status.

Basic Camera Settings	Basic Info
Basic Info	Basic Info
Image	Model: OE-C3012T4-S-1
Video	IPv4 Network Info: 172.30.42.179/255.255.255.0/172.40.1
Network	MAC Address: 4c:91:7a:68:4:20
Time	
Network Settings	Version Info
Streaming Settings	Firmware Version: IPC-B6202.5.82.C05519.NB.22310
Picture Settings	Hardware Version: A
Analytics	Boot Version: V2.0
Event Settings	Serial No.: 210235TQYM321B0001
Storage Settings	
Security Settings	Status
Maintenance	System Time: 2022/3/30 11:48:27
	Operation Time: 0 Day(s) 22 Hour(s) 23 Minute(s)
	Intelligent Server 1: Offline
	Intelligent Server 2: Online
	<input type="button" value="Refresh"/>

The nested Image, Video, Network, and Time tabs are shortcuts to the more advanced menu options further down the Setup list. For more information about these tabs, see the appropriate sections later in the manual.

NETWORK SETTINGS

Network

The Network tab allows you to configure the connected camera network settings.

DHCP IP Address

The default static IP address of the camera is 192.168.51.2, and the default subnet mask is 255.255.255.0. DHCP is turned on by default.

If a DHCP server is used in the network, the IP address of your camera may be assigned dynamically.

The image displays two side-by-side screenshots of the Network Settings configuration page. Both screenshots show the 'Network' tab selected. The left screenshot shows the 'DHCP/Static IP' dropdown menu set to 'DHCP'. The right screenshot shows the 'DHCP/Static IP' dropdown menu set to 'Static', with the following values entered: IP Address: 192.168.51.3, Subnet Mask: 255.255.255.0, and Default Gateway: 192.168.51.1. Both screenshots also show the 'IPv6' section with 'IPv6 Mode' set to 'Manual', 'Prefix Length' set to 64, and 'Default Gateway' empty. The 'DNS' section shows 'Preferred DNS Server' as 8.8.8.8 and 'Alternate DNS Server' as 8.8.4.4. The 'MTU' is set to 1500, 'Port Type' is 'FE Port', and 'Operating Mode' is 'Auto-negotiation'. A 'Save' button is visible at the bottom of each form.

Static IP Address

To set up a new static IP address:

1. Select **Static** from the **DHCP/Static IP** dropdown option.
2. Enter the **IP Address**, **Subnet Mask**, and **Default Gateway**.

***Note** - Make sure that the IP address of the camera is unique in the network.

3. **Save**

IPv6 Address Configuration

1. Enter the **IPv6 Address**, set the **Prefix Length** and **Default Gateway**.

***Note** - Make sure that the IP address of the camera is unique in the network.

2. **Save**

DNS

Set your **Preferred DNS Server** and **Alternate DNS Server**.

Port

Port

HTTP Port

HTTPS Port

RTSP Port

Note: Modifying the RTSP port number will cause the device to restart.

Port Mapping On Off

Mapping Type

UPnP Mapping

Port Type	External Port	External IP Address	Status
HTTP Port	<input type="text" value="80"/>	0.0.0.0	Inactive
Server Port	<input type="text" value="81"/>	0.0.0.0	Inactive
RTSP Port	<input type="text" value="554"/>	0.0.0.0	Inactive
HTTPS Port	<input type="text" value="443"/>	0.0.0.0	Inactive

HTTP Port – Configure your relevant port number.



Note If the HTTP port number has been occupied already, a “Port conflicts” message will display. Ports 23, 81, 82, 85, 3260, and 49152 are occupied by default.

HTTPS Port – The default HTTPS Port is 443; setting range: 1024 ~65535.

RTSP Port – The default RTSP port is 554; setting range: 1024 ~65535.



Note No port number can be used in duplication on more than one item.

Port Mapping

To enable Port Mapping:

1. Toggle **On** for **Port Mapping**.
2. Use the **Mapping Type** dropdown menu to select a type.
3. Use the **UPnP Mapping** dropdown menu to select a type.
4. If selecting **Manual** in either dropdown, the external ports must be configured.



Note If the configured port is already occupied, then the Status will show as inactive and a new port must be selected.

5. **Save**

DDNS

DDNS

DDNS Service On Off

DDNS Type

Server Address

Domain Name

Username

Password

Confirm

1. **Enable** DDNS Service.
2. Select a **DDNS Type**.
3. Enter **Server Address**, **Domain Name**, **Username** and **Password**.
4. **Save**

FTP

Use FTP (**file transfer protocol**) to upload snapshots from network cameras to a specified server.

General

General | **Smart** | **Video**

Server Parameters

Server IP	<input type="text" value="0.0.0.0"/>	Upload Images	<input type="checkbox"/>
Port No.	<input type="text" value="21"/>	Overwrite Storage	<input type="checkbox"/>
Username	<input type="text"/>	Overwrite At(image)	<input type="text" value="1000"/>
Password	<input type="password"/>	<input type="button" value="Test"/>	

Snapshot Image

Save To

Root Directory

\ \ \ \ \ \

File Name

Separator

No.	Naming Element
1	<input type="text" value="None"/>
2	
3	
4	
5	
..	

Note:Overwrite will take place in the current directory.

To configure FTP:

1. Set the **Server IP** address and **Port No.** for the FTP server, **Username** and **Password** used to upload images to the FTP server, select **Upload Images**, **Overwrite Storage** and set **Overwrite At** (threshold for overwriting images).
2. Set the path for saving snapshots on the FTP server and the file name format.

Example: set path as Preset No.\\IP Address\\Date\\Hour(s), and set file name as Preset No.-PTZ Zoom-PTZ Latitude-PTZ Longitude.jpg.

3. **Save.**

Smart

Use Smart FTP (**file transfer protocol**) to upload snapshots captured in smart motion events.

Server Parameters

Server IP: 0.0.0.0 Direction ID: 1

Port No.: 21 Not Upload Pictures:

Username: Custom Naming Rules:

Password: Convert Path into UTF8 Format:

Snapshot Image

Save To

Root Directory: None \\ None \\ None \\ None

File Name

Separator: -

No.	Naming Element	Naming Rule
1	None	
2		
3		
4		
5		

Save

To configure Smart FTP:

1. Set the **Server IP** address and **Port No.** for the FTP server, **Username** and **Password** used to upload images to the FTP server.
2. Set **Direction ID**.
3. Check to enable the following:
 - a. **Not Upload Pictures**
 - b. **Custom Naming Rules**
 - c. **Convert Path into UTF8 Format**
4. Set the path for saving snapshots on the FTP server and the file name format.

Example: set path as Preset No.\\IP Address\\Date\\Hour(s), and set file name as Preset No.-PTZ Zoom-PTZ Latitude-PTZ Longitude.jpg.
5. **Save.**

Video

Use Smart FTP (**file transfer protocol**) to upload video from network cameras to a specified server.

The screenshot shows a configuration interface with three tabs: General, Smart, and Video. The Video tab is active. Under the 'Server Parameters' section, there are four input fields: 'Server IP' (0.0.0.0), 'Port No.' (21), 'Username' (empty), and 'Password' (masked with dots). To the right of these fields is a checkbox labeled 'Upload Video' which is currently unchecked. Below this is a 'Recording Path' section with a 'Save To' label and a 'Root Directory' label. The 'Root Directory' is represented by four dropdown menus, each currently set to 'Disable', separated by double backslashes. At the bottom of the form is a 'Save' button.

1. Set the **Server IP** address and **Port No.** for the FTP server, **Username** and **Password** used to upload images to the FTP server.
2. Check **Upload Video**.
3. Set the path for saving snapshots on the FTP server and the file name format.

Example: set path as Preset No.\\IP Address\\Date\\Hour(s), and set file name as Preset No.-PTZ Zoom-PTZ Latitude-PTZ Longitude.jpg.

4. **Save.**

Email

The camera can send an e-mail via Simple Mail Transfer Protocol (SMTP) when a variety of events occur. Two sets of SMTP accounts can be configured. Each set includes SMTP Server, Account Name, Password and E-mail Address settings. For SMTP server, contact your network service provider for more specific information.

E-mail

Sender

Name

Address

SMTP Server

SMTP Port

TLS/SSL On Off

Snapshot Interval(s) Attach Image

Server Authentication On Off

Username

Password

Recipient

Name1

Address1

Name2

Address2

Name3

Address3

Parameter	Description
TLS/SSL	When enabled, the e-mail will be encrypted using TLS (Transport Layer Security) or Secure Socket Layer (SSL) to protect privacy. First it tries to send through an SSL connection. If the SMTP server supports SSL, the e-mail will be sent through the SSL connection; otherwise, it tries to send using STARTTLS.
Attach Image	When enabled, the e-mail will contain 3 instant snapshots as attachment according to the Capture Interval.
Username/Password	Username and password of the registration email address. The password allows the following special characters \ / : * ? ' " < > % &

STREAMING SETTINGS

Video

The video settings menu configures the camera's video settings, including **Resolution**, **Frame Rate**, **Bit Rate**, and the **Image Quality**.

Resolution and Frame Rate Mode: 1920x1080@30

Main Stream

Video Compression: H.264
Resolution: 1920x1080
Frame Rate(fps): 15
Bit Rate(Kbps): 2048
Bitrate Type: VBR
Image Quality: Bit Rate / Quality
Smart Encoding: Basic Mode

Enable Sub Stream

Video Compression: H.264
Resolution: 640x360
Frame Rate(fps): 10
Bit Rate(Kbps): 512
Bitrate Type: VBR
Image Quality: Bit Rate / Quality
I Frame Interval: 10
GOP: IP
Smoothing: Clear / Smooth

Save

To configure camera streams:

Use the dropdown menus to configure the **Video Compression**, **Resolution**, **Frame Rate**, **Bitrate Type**, **Smart Encoding**, and **GOP**.

1. Check to **Enable Sub Stream** and configure if desired.
2. **Save**

Smart Encoding – Turn on Smart Encoding to enable H.264+ encoding to reduce bit rate. It is recommended not to set the frame rate below 10FPS when smart compression is enabled.

Resolution and Frame Rate – Use the dropdown menu to select the base resolution and frame rate for the main stream.



Note Higher frame rate will increase video smoothness but will increase file size and bandwidth usage. Lowering the frame rate will conserve file size and bandwidth usage at the expense of video smoothness.

Video Compression – H.264, H.265, and MJPEG are available for video compression.

Image Quality – If the Encoding Mode is set to VBR, you can adjust the quality level for images by moving the sliding bar. The Quality side of the bar improves video quality, and the Bit Rate side of the bar reduces Bit rate.

I-Frame Interval / GOP – The Group of Pictures setting allows you to modify the frame structure of the video stream. This setting changes the frequency of the I-frames that occur within the stream of P-frames. Increasing this number increases the number of P-frames between each I-frame, decreasing the file size of the stream, but increasing the risk of video decoding errors. It is recommended setting the GOP to be approximately twice the frame rate.

Smoothing – Configure the amount of video smoothing. Moving the sliding bar toward Smooth increases the level of smoothing but may affect image quality.



Note In a poor network environment, you can increase smoothing to get more fluid video.

Stream URLs / RTSP

It is possible to connect to OpenEye IP cameras using third party software like VLC media player.

To connect some types of software will need to know the stream URL. All OpenEye IP cameras can deliver two RTSP streams.

The RTSP stream URL format is as follows:

`rtsp://[USER]:[PASSWORD]@[IP ADDRESS]:[RTSP PORT]/media/video[STREAM]`

[USER] – This is the username to access your device

[PASSWORD] – This is the password to the user

[IP ADDRESS] – This is the IP address of your device

[RTSP PORT] – This is the RTSP port of your device; the default RTSP Port is 554

[STREAM] –

- Primary Stream: video1
- Sub-stream: video2

Example:

[USER]	<i>admin</i>
[PASSWORD]	<i>1\$S!9#6v\$\$\$1</i>
[IP ADDRESS]	<i>192.168.51.51</i>
[RTSP PORT]	<i>554</i>
[STREAM]	<i>1</i>

RTSP Stream URL - `rtsp://admin:1$S!9#6v$$$1@192.168.51.51:554/media/video1`

Snapshot

Snapshot

Resolution

Most Large(KB)

Scheduled Snapshot

Snapshot Interval

Number to Snapshot

Snapshot Mode Schedule Repeat

No.	Snapshot Time	+
1	14:20:00	-
2	14:21:00	-
3	14:22:00	-
		+
		+
		+

The Snapshot tab is used to configure the settings for timed or continual snapshots.

To configure Snapshots:

1. Use the dropdowns to select the desired **Resolution**, **Snapshot Interval**, and the **Number of Snapshots**.
2. If you desire Scheduled Snapshots, select **Schedule** Snapshot Mode, and designate snapshot times.
3. **Save**

Parameter	Description
Snapshot Interval	Interval between two snapshots. For example, with Snapshot Interval set to 1 and Number of Snapshot set to 2, the camera will take 2 snapshots (take one first and then take another after 1 second).
Number to Snapshot	Currently 1, 2, and 3 snapshots are allowed.
Snapshot Mode	<p>Schedule: You need to set a snapshot time, e.g., 19:12:00, which means the camera takes a snapshot at 19:12:00.</p> <p>Repeat: Allows you to set an interval (unit: sec). For example, according to the settings shown in the figure above, 60 seconds must elapse before the camera takes another two snapshots.</p>

Audio

The Audio tab allows you to configure the audio encoding settings for your camera.

Audio

Audio Input

Audio Input On Off

Access Mode

Input Volume 50

Audio Compression

Sampling Rate(KHz)

Noise Suppression On Off

Audio L Enable

Save

To configure Audio setup:

1. Configure the Audio settings as desired.
2. **Save**

Parameter	Description
Audio Input	No audio data will be encoded when Off is selected.
Access Mode	Line/Mic
Input Volume	Audio signal amplification for sampling. The greater the gain, the greater amplification.
Audio Compression	Two options: G.711U, G.711A. G.711U and G.711A support 8K sampling rate only.
Noise Suppression	Reduces background noise to improve clarity of voices. To enable noise suppression, select On .
Audio L	To enable audio input, select Enable .

Region of Interest (ROI)

When Region of Interest (ROI) is enabled, the system ensures the image quality for the ROI first if the bit rate is insufficient.

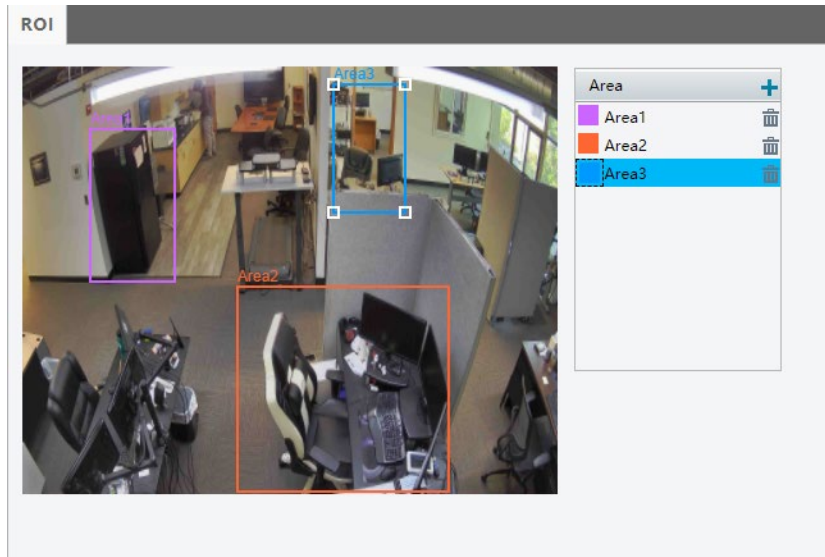

To enable ROI:

1. Click **+** on the Area box.
2. Arrange the ROI square as desired in the camera image. Click and drag to move the square and use the corner markers to expand the square. The interior of the ROI square will be considered the ROI.
3. Click **+** again to add additional ROIs.
4. Click the trash icon to delete a created ROI.

Changes will be saved automatically.

Media Stream

You can display the established media streams from a camera. You can also set the camera to transmit code streams by the UDP or TCP protocol to a specified IP address and port number.



Note Changes to the media stream will take effect after the camera has been restarted.

Media Stream

Stream Profile	Protocol	Destination IP	Destination ...	Persistent	Status	+
Sub Stream	TCP	172.30.42.100	49706	Disable	Streaming	🗑️
Main Stream	TCP	172.30.42.100	49705	Disable	Streaming	🗑️
Sub Stream	TCP	172.30.42.106	61609	Disable	Streaming	🗑️
Main Stream	TCP	172.30.42.106	61491	Disable	Streaming	🗑️

Main Stream

Multicast Address:

Port:

Sub Stream

Multicast Address:

Port:

To configure media streams:

1. Click the **+** on the right side of the title bar and the Add Media Stream page will appear.

Stream Profile	Protocol	Destination IP	Destination ...	Persistent	Status	+
----------------	----------	----------------	-----------------	------------	--------	---

2. Select a **Stream Type**, and then set the **IP Address** and **Port Number** of the unicast or multicast group for the decoding device that receives audio and video streams from the camera.

Add Media Stream

Stream Profile:

IP Address:

Port:

Protocol:

Persistent: Enable Disable

3. Toggle **Persistent** to **Enable** if you want the device to establish the media stream that you have just configured automatically upon each subsequent restart.
4. **Save**
5. Click the trashcan icon to **delete** a created media stream.

Stream Profile	Protocol	Destination IP	Destination ...	Persistent	Status	+
Sub Stream	TCP	172.30.42.100	49706	Disable	Streaming	🗑️

PICTURE SETTINGS

Image

The Image tab allows you to configure the setting for the camera image as seen in Live View. When adjusting your image settings, the changes will be saved automatically and will display in the camera image preview window.

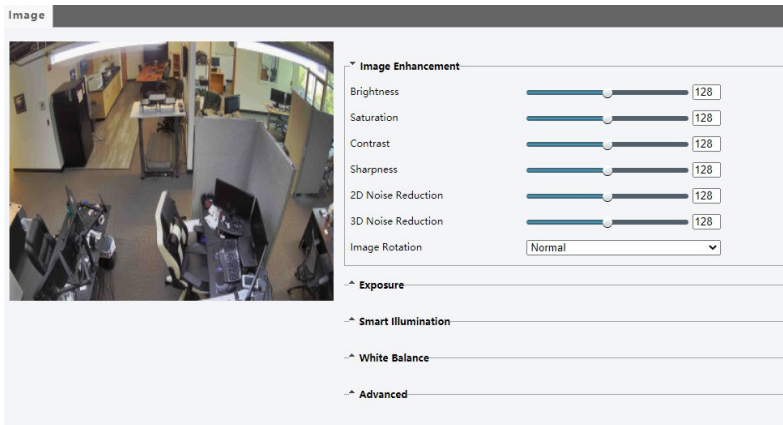

Image Enhancement

Use the sliding scales to adjust the Image settings or set a numeric value in the value box. The dropdown Image Rotation menu will rotate the camera image.



Exposure

By default, the Exposure Mode is set to Automatic. Other options include Custom, Indoor 50hz, Indoor 60hz, and Manual. Using Custom or Manual allows you to manually configure the shutter and gain control.

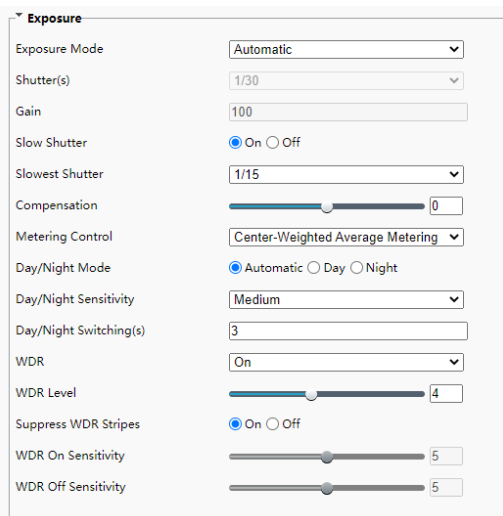

Parameter	Description
Exposure Mode	<ul style="list-style-type: none"> • Automatic: The camera automatically adjusts exposure according to the environment. • Custom: The user sets exposure as needed. • Indoor 50Hz: Reduce stripes by limiting shutter frequency. • Indoor 60Hz: Reduce stripes by limiting shutter frequency. • Manual: Finetune image quality by setting shutter, gain and iris manually. • Low Motion Blur: Control the minimum shutter to reduce motion blur in faces captured in motion.
Shutter (s)	<p>Shutter is used to control the light that comes into the lens. A fast shutter speed is ideal for scenes in quick motion. A slow shutter speed is ideal for scenes that change slowly.</p> <p>Note:</p> <ul style="list-style-type: none"> • You can set a shutter speed when Exposure Mode is set to Manual or Shutter Priority. • If Slow Shutter is set to Off, the reciprocal of the shutter speed must be greater than the frame rate.
Gain	<p>Control image signals so that the camera outputs standard video signals according to the light condition.</p> <p>Note: You can set this parameter only when Exposure Mode is set to Manual or Gain Priority.</p>
Slow Shutter	Improves image brightness in low light conditions.
Slowest Shutter	<p>Set the slowest shutter speed that the camera can use during exposure.</p> <p>Note: You can set this parameter only when Slow Shutter is set to On.</p>
Compensation	<p>Adjust the compensation value as required to achieve the desired effects.</p> <p>Note: You can set this parameter only when Exposure Mode is not set to Manual.</p>
Metering Control	<p>Set the way the camera measures the intensity of light.</p> <ul style="list-style-type: none"> • Center-Weighted Average Metering: Measure light mainly in the central part of images. • Evaluative Metering: Measure light in the customized area of images. • Face Metering: Adjust image quality in poor lighting conditions by controlling the brightness of captured face in Face scene. • Spot Metering: Adjust image quality in high contrast conditions to use a small, selected area as the light source <p>Note: You can set this parameter only when Exposure Mode is not set to Manual.</p>
Day/Night Mode	<p>Automatic: The camera outputs the optimum images according to the light condition. In this mode, the camera can switch between night mode and day mode automatically.</p> <p>Night: The camera provides high-quality black and white images using the existing light</p> <p>Day: The camera provides high-quality color images using the existing light.</p>
Day/Night Sensitivity	<p>Light threshold for switching between day mode and night mode. A higher sensitivity means that the camera is more sensitive to the change of light and becomes more easily to switch between day mode and night mode.</p> <p>Note: You can set this parameter only when Day/Night Mode is set to Automatic.</p>

Day/Night Switching(s)	Set the length of time before the camera switches between day mode and night mode after the conditions for switching are met. Note: You can set this parameter only when Day/Night Mode is set to Automatic .
WDR	Enable WDR to distinguish the bright and dark areas in the same image. Note: You can set this parameter only when Exposure Mode is neither Customize nor Manual and when Image Stabilizer is disabled.
WDR Level	After enabling the WDR function, you can improve the image by adjusting the WDR level. Note: Use level 7 or higher when there is a high contrast between the bright and dark areas of the scene. In the case of low contrast, it is recommended to disable WDR or use level 1-6.
Suppress WDR Stripes	When enabled, the camera can automatically adjust slow shutter frequency according to the frequency of light to minimize stripes that may appear in images.

Smart Illumination

Smart Illumination

Smart Illumination On Off

Lighting Type

Control Mode

Illumination Level

Parameter	Description
Lighting Type	<ul style="list-style-type: none"> • Infrared: The camera uses infrared light illumination.
Control Mode	<ul style="list-style-type: none"> • Global Mode: The camera adjusts IR illumination and exposure to achieve balanced image effects. Some areas might be overexposed if you select this option. This option is recommended if monitored range and image brightness are your first priority. • Overexposure Restrain: The camera adjusts IR illumination and exposure to avoid regional overexposure. Some areas might be dark if you select this option. This option is recommended if clarity of the central part of the image and overexposure control are your first priority. • Custom Level: This mode allows you to manually control the intensity of IR illumination.
Illumination Level	Set the intensity level of the IR light. The greater the value, the higher the intensity. 0 means that the IR light is turned off. Note: You can set this parameter only when Control Mode is set to Manual .

White Balance

White balance is the process of offsetting unnatural color cast in images under different color temperatures so as to output images that best suit human eyes.

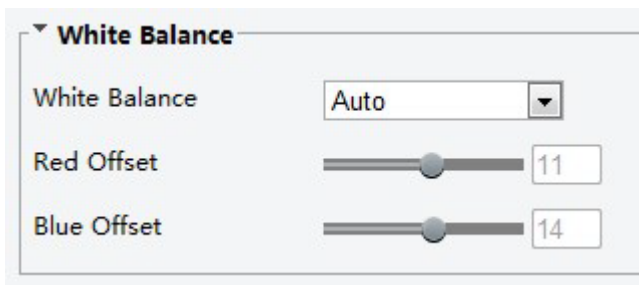

Parameter	Description
White Balance	<p>Adjust the red or blue offset of the image:</p> <p>Auto/Auto2: The camera adjusts the red and blue offset automatically according to the light condition (the color tends to be blue). If the images are still unnaturally red or blue in Auto mode, please try Auto2.</p> <p>Outdoor: Suitable for outdoor environment with a relatively greater color temperature range.</p> <p>Fine Tune: Allow you to adjust the red and blue offset manually.</p> <p>Sodium Lamp: The camera adjusts red and blue offset automatically according to the light condition (the color tends to be red).</p> <p>Locked: Lock the current color temperature without change.</p>
Red Offset	<p>Adjust the red offset manually.</p> <p>Note: You can set this parameter only when White Balance is set to Fine Tune.</p>
Blue Offset	<p>Adjust the blue offset manually.</p> <p>Note: You can set this parameter only when White Balance is set to Fine Tune.</p>

Advanced

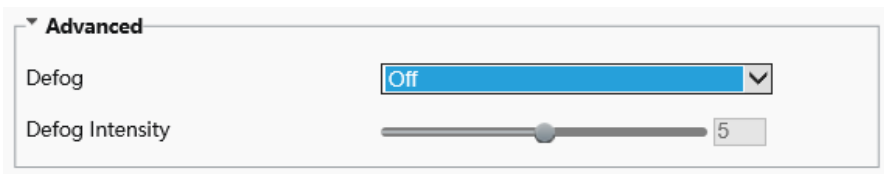

Defog – Adjust the clarity of images captured in fog or haze conditions.

- Use the Defog dropdown menu to turn Defog **On** or **Off**.
- Slide the **Defog Intensity** bar to the desired position (1 is the minimum intensity and 9 is the maximum intensity).



Note The Defog function is only available when WDR is disabled.

On-Screen Display

Up to 8 on-screen displays (OSD) can be configured for the camera image.

Live View



Enable	No.	Overlay OSD Content	X-Axis	Y-Axis
<input type="checkbox"/>	1		2	3
<input type="checkbox"/>	2		75	3
<input type="checkbox"/>	3		2	75
<input type="checkbox"/>	4		0	0
<input type="checkbox"/>	5		0	0
<input type="checkbox"/>	6		0	0
<input type="checkbox"/>	7		0	0
<input type="checkbox"/>	8		0	0

Display Style

Effect: Background

Font Size: Medium

Min. Margin: None

Date Format: MM/dd/yyyy dd=Day; dddd=Day of the week; M=Month; y=Year

Time Format: HH:mm:ss h/H=12/24 Hour; tt=A.M. or P.M.; mm=Minute; ss=Second

To add an on-screen display:

1. Select the position and content of the OSD.
 - a. **Position:** Click the desired box in the Live View area. After the cursor shape is changed, click and hold the button to move the box to the desired position. To set the position precisely, use the X and Y coordinates.
 - b. **Overlay OSD Content:** The drop-down list provides Time, Preset and Serial Info. You may also select Custom and enter the content you want.
2. After you have completed the settings, a message appears to indicate the successful settings.
3. To cancel OSD for an area, clear the OSD content in the Overlay OSD Content column.



Note To view the OSD in the web browser Live View, you must refresh the browser after setting the OSD for the changes to take effect.

Privacy Mask

Add a privacy mask to your camera image to hide desired areas from view.

Privacy Mask

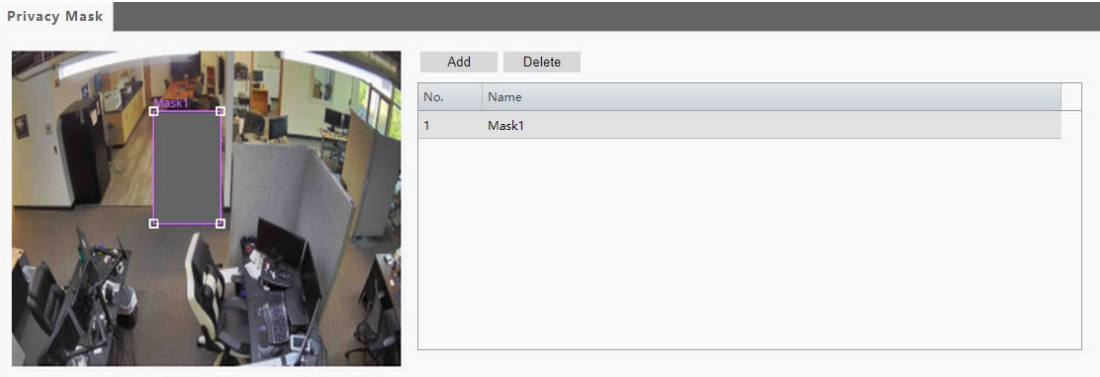

No.	Name
1	Mask1

To **add** a privacy mask:

1. Click **Add**.
2. Click and drag the newly generated **mask square** to the desired location on the camera image. Arrange and resize the mask as needed.

To **delete** a privacy mask:

1. Select the desired mask from the Privacy Mask list.
2. Click **Delete**.

Changes will be saved automatically.

ANALYTICS

Intrusion Detection

Rule Settings

Intrusion Detection

Intrusion Detection

Rule Settings | Trigger Actions | Plan

Detection Rule

- Rule1
- Rule2

Rule1

Time Threshold(s)

Sensitivity

Analytic Vehicle Detection Person Detection

Filter Type

Max. Size X

Min. Size X

Save

1. Check **Intrusion Detection** to enable.
2. In the **Detection Rule** area, click to add a new detection area. To delete a detection area, click .
3. Drag the borders of the box to set the intended position and range.
4. Set **Time Threshold** and **Sensitivity** for the camera to decide whether to report an intrusion detection alarm.
 - **Time Threshold:** The minimum length of time that the intruder stays in the detection area before an alarm will be reported.
 - **Sensitivity:** Sensitivity of detection. A greater value means higher detection sensitivity.



Note Setting sensitivity too high will increase the likelihood of false alerts.

5. Check either **Vehicle Detection** or **Person Detection**.
6. Choose the Vehicle Detection or Person Detection **Filter Type**.
7. Enable **Max. Size** or **Min. Size** to resize the filter detection box to a default size.
8. **Save**

Trigger Actions

1. Check the boxes to choose the actions that are triggered when a person or vehicle is detected.
2. **Save**

Intrusion Detection

Intrusion Detection

Rule Settings Trigger Actions Plan

Conventional	Alarm Output	Storage
<input type="checkbox"/> Send E-mail <input checked="" type="checkbox"/> Upload Image(Original)	<input type="checkbox"/> A → 1	<input type="checkbox"/> Record Video to SD card <input type="checkbox"/> Save Snapshot to SD card <input type="checkbox"/> Record Video to FTP Server

Save

Item	Description
Send Email	With Send E-mail selected, the camera will automatically send snapshots to the specified E-mail addresses when a person or vehicle is detected. Note: Make sure you have completed E-Mail Recipient configuration before using this function.
Upload Image (Original):	With Upload Image selected, the camera will automatically upload snapshots to the recorder when a person or vehicle is detected.
Alarm Output	This setting is the alarm output interface linked to motion detection alarm. Note: When an alarm is reported, the camera triggers alarm output to trigger actions by a third-party device.
Record Video to SD Card	With Record Video to SD Card selected, the camera will automatically record video to the SD Card when a person or vehicle is detected. Note: Make sure you have completed Storage configuration before using this function.
Save Snapshot to SD Card	With Record Snapshot to SD Card selected, the camera will automatically save an image to the SD Card when a person or vehicle is detected. Note: Make sure you have completed Storage configuration before using this function.
Record Video to FTP Server	With Record Video to FTP Server selected, the camera will automatically upload video to the specified FTP server when a person or vehicle is detected. Note: Make sure you have completed FTP configuration before using this function.

Plan

Enable Schedule

Armed Unarmed Edit

	0	1	2	3	4	5	6	7	8	9	10	11	12	13	14	15	16	17	18	19	20	21	22	23	24
Mon																									
Tue																									
Wed																									
Thu																									
Fri																									
Sat																									
Sun																									

Save

1. Click **Armed** or **Unarmed** and click the schedule to set when enabled Trigger Actions are effective.

Edit ✕

Mon Tue Wed Thu Fri Sat Sun

No.	Start Time	End Time
1	00:00:00 <input type="text"/>	04:00:00 <input type="text"/>
2	14:00:00 <input type="text"/>	23:59:59 <input type="text"/>
3	<input type="text"/>	<input type="text"/>
4	<input type="text"/>	<input type="text"/>

Copy To Select All

Mon Tue Wed Thu Fri Sat Sun

Copy

OK Cancel

2. Click **Edit**.
3. Set the start and end times during which Trigger Actions are effective. The time periods cannot overlap. The camera reports alarms during the specified period(s) only.
4. Select from Monday to Sunday and set up to four periods for each day or check the days and **Copy** to set the same schedule for multiple days.
5. Click **OK**.
6. **Save**

Line Crossing Detection

Rule Settings



Line Crossing Detection

Line Crossing Detection

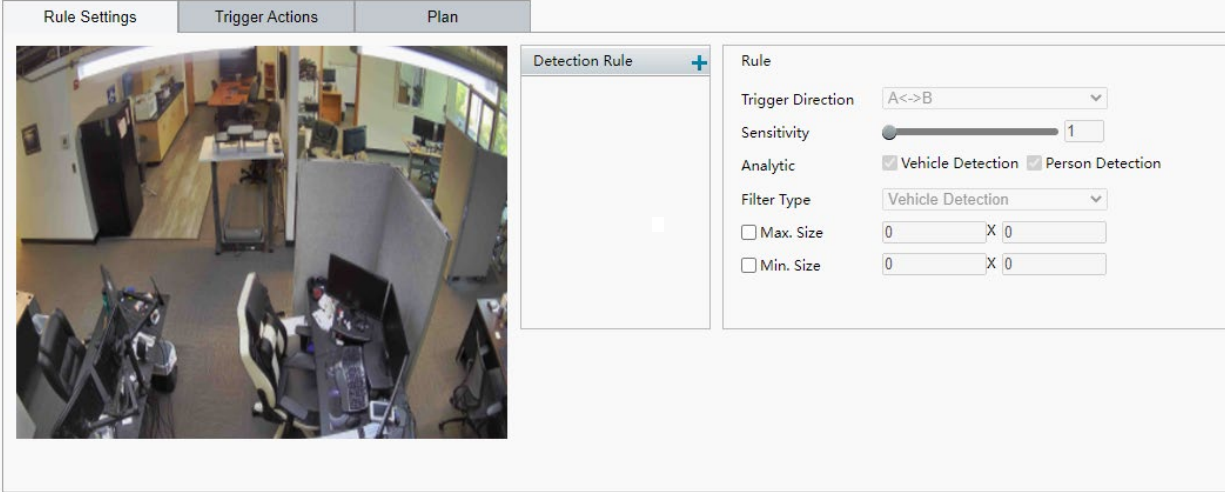
Rule Settings Trigger Actions Plan



Save

1. Check **Line Crossing Detection** to enable.
2. In the **Detection Rule** area, click  to add a new detection area. To delete a detection area, click .
3. Drag the line to set the intended position.
4. Drag the ends of the line to set the length and angle.
5. Set **Trigger Direction** and **Sensitivity** for the camera to decide from which direction to report an intrusion detection alarm.
 - **Trigger Direction:** Set from which direction a crossed line will trigger or if it will trigger when crossed from both directions.
 - **Sensitivity:** Sensitivity of detection. A greater value means higher detection sensitivity.



Note Setting sensitivity too high will increase the likelihood of false alerts.

6. Check either **Vehicle Detection** or **Person Detection**.
7. Choose the Vehicle Detection or Person Detection **Filter Type**.
8. Enable **Max. Size** or **Min. Size** to resize the filter detection box to a default size.
9. **Save**

Trigger Actions

1. Check the boxes to choose the actions that are triggered when a person or vehicle is detected.
2. **Save**

Line Crossing Detection

Line Crossing Detection

Rule Settings Trigger Actions Plan

Conventional	Alarm Output	Storage
<input type="checkbox"/> Send E-mail <input checked="" type="checkbox"/> Upload Image(Original)	<input type="checkbox"/> A → 1	<input type="checkbox"/> Record Video to SD card <input type="checkbox"/> Save Snapshot to SD card <input type="checkbox"/> Record Video to FTP Server

Save

Item	Description
Send Email	With Send E-mail selected, the camera will automatically send snapshots to the specified E-mail addresses when a person or vehicle is detected. Note: Make sure you have completed E-Mail Recipient configuration before using this function.
Upload Image (Original):	With Upload Image selected, the camera will automatically upload snapshots to the recorder when a person or vehicle is detected.
Alarm Output	This setting is the alarm output interface linked to motion detection alarm. Note: When an alarm is reported, the camera triggers alarm output to trigger actions by a third-party device.
Record Video to SD Card	With Record Video to SD Card selected, the camera will automatically record video to the SD Card when a person or vehicle is detected. Note: Make sure you have completed Storage configuration before using this function.
Save Snapshot to SD Card	With Record Snapshot to SD Card selected, the camera will automatically save an image to the SD Card when a person or vehicle is detected. Note: Make sure you have completed Storage configuration before using this function.
Record Video to FTP Server	With Record Video to FTP Server selected, the camera will automatically upload video to the specified FTP server when a person or vehicle is detected. Note: Make sure you have completed FTP configuration before using this function.

Plan

Enable Schedule

Armed Unarmed Edit

	0	1	2	3	4	5	6	7	8	9	10	11	12	13	14	15	16	17	18	19	20	21	22	23	24
Mon																									
Tue																									
Wed																									
Thu																									
Fri																									
Sat																									
Sun																									

Save

1. Click **Armed** or **Unarmed** and click the schedule to set when enabled Trigger Actions are effective.

Edit ✕

Mon Tue Wed Thu Fri Sat Sun

No.	Start Time	End Time
1	00:00:00 <input type="text"/>	04:00:00 <input type="text"/>
2	14:00:00 <input type="text"/>	23:59:59 <input type="text"/>
3	<input type="text"/>	<input type="text"/>
4	<input type="text"/>	<input type="text"/>

Copy To Select All

Mon Tue Wed Thu Fri Sat Sun Copy

OK Cancel

2. Click **Edit**.
3. Set the start and end times during which Trigger Actions are effective. The time periods cannot overlap. The camera reports alarms during the specified period(s) only.
4. Select from Monday to Sunday and set up to four periods for each day or check the days and **Copy** to set the same schedule for multiple days.
5. Click **OK**.
6. **Save**

EVENT SETTINGS

Alarms

Motion Detection

Motion detection is used to detect motion in a specified area during a period of time. The use of motion detection requires setting a snapshot area, detection sensitivity, object size, and history. When these requirements are met, the motion detection alarm will activate.

The screenshot shows the 'Motion Detection' configuration window. It includes a 'Detection Mode' dropdown set to 'Area', a camera image with a 'Snapshot Area' box, sliders for 'Sensitivity' and 'Object Size', and 'Alarm Parameters' for 'Suppress Alarm(s)' (15) and 'Clear Alarm(s)' (5). A 'Save' button is located at the bottom left.

To configure Motion Detection:

1. Click **+** in **Snapshot Area** and drag the **detection box** to the desired location on the camera image and use the corner markers to adjust the size of the detection box as desired.
2. Use the **Sensitivity** and **Object Size** slider bars to adjust the motion detection parameters as desired.

Sensitivity – This determines how many pixels have to change in order for the alarm to consider motion to have occurred.

Object Size – This determines the area within the camera image that the motion must exceed in order for the alarm to consider motion to have occurred.

Alarm Parameters

Suppress Alarm – After an alarm is triggered, the same alarm will not be reported again within the designated time.

Clear Alarm – After the alarm is triggered:

- a) If the same alarm is not triggered within the set time, the alarm will be cleared and the same alarm can be reported again.
- b) If the same alarm is triggered within the set time, the alarm will not be cleared until the suppress alarm time expires. Then the same alarm can be reported again.

Click **Save** and then select the **Trigger Actions** to occur once the motion detection alarm has been triggered.

Trigger Actions

Motion Detection

Rule Settings Trigger Actions Plan

Conventional	Storage
<input type="checkbox"/> Upload to FTP <input type="checkbox"/> Send E-mail	<input type="checkbox"/> Record Video to SD card <input type="checkbox"/> Save Snapshot to SD card <input type="checkbox"/> Record Video to FTP Server

Save

Item	Description
Upload to FTP	With Upload to FTP selected, the camera will automatically upload snapshots to the specified FTP server when a person or vehicle is detected. Note: Make sure you have completed FTP configuration before using this function.
Send Email	With Send E-mail selected, the camera will automatically send snapshots to the specified E-mail addresses when a person or vehicle is detected. Note: Make sure you have completed E-Mail Recipient configuration before using this function.
Record Video to SD Card	With Record Video to SD Card selected, the camera will automatically record video to the SD Card when a person or vehicle is detected. Note: Make sure you have completed Storage configuration before using this function.
Save Snapshot to SD Card	With Record Snapshot to SD Card selected, the camera will automatically save an image to the SD Card when a person or vehicle is detected. Note: Make sure you have completed Storage configuration before using this function.
Record Video to FTP Server	With Record Video to FTP Server selected, the camera will automatically upload video to the specified FTP server when a person or vehicle is detected. Note: Make sure you have completed FTP configuration before using this function.

Plan

Enable Schedule

Armed Unarmed Edit

	0	1	2	3	4	5	6	7	8	9	10	11	12	13	14	15	16	17	18	19	20	21	22	23	24
Mon																									
Tue																									
Wed																									
Thu																									
Fri																									
Sat																									
Sun																									

Save

1. Click **Armed** or **Unarmed** and click the schedule to set when enabled Trigger Actions are effective.

Edit ✕

Mon Tue Wed Thu Fri Sat Sun

No.	Start Time	End Time
1	00:00:00 <input type="text"/>	04:00:00 <input type="text"/>
2	14:00:00 <input type="text"/>	23:59:59 <input type="text"/>
3	<input type="text"/>	<input type="text"/>
4	<input type="text"/>	<input type="text"/>

Copy To Select All
 Mon Tue Wed Thu Fri Sat Sun Copy

OK Cancel

2. Click **Edit**.
3. Set the start and end times during which Trigger Actions are effective. The time periods cannot overlap. The camera reports alarms during the specified period(s) only.
4. Select from Monday to Sunday and set up to four periods for each day or check the days and **Copy** to set the same schedule for multiple days.
5. Click **OK**.
6. **Save**

STORAGE SETTINGS

Storage

OpenEye IP cameras include an integrated microSD™ card (Memory Card) slot that can be used to record video or images. The card slot is compatible with a microSD™ card up to 512GB.

Storage Medium: Memory Card [Format] [Enable]

Storage Medium Status: No card

Total Capacity 0 GB, Free Space 0 GB.

Allocate Capacity

Video(GB): 0 (The remaining capacity is used for image storage.)

Common Snapshot(GB): 0

Video Storage Info

Storage Policy: Manual Storage Planned Storage Off

Stream: Main Stream

When Storage Full: Overwrite Stop

Post-Record(s): 10

Save

- Note** Formatting the microSD card causes the camera to restart
- Note** Camera date and time must be synced with system or server to insure accurate recording timestamps

Format

To format the memory card, check **Enable** and to confirm the operation. The system will restart when the format is completed.

Allocate Capacity

Video (MB) – Enter the amount of storage space to be allocated only to video recordings.

Common Snapshot (MB) – This is the remaining storage after video recordings which will be used to store snapshot images.

Video Storage Info

Storage Policy

Manual Storage – records video to the SD card continuously.

Planned Storage – camera records video to the memory card during the specified periods. (shown below)

Off – No recorded video will be saved to the SD card.

Stream – Choose which stream is saved.

When Storage Full

Overwrite – When the SD card is full, new data will begin overwriting oldest data.

Stop – When the SD card is full, video recording will stop writing to the SD card.

Post-Record(s) – For alarm-triggered recording; this is the length of time (seconds) that recording continues after the end of the alarm. Enter an integer range of [30–1800].

Save

Snapshot Download

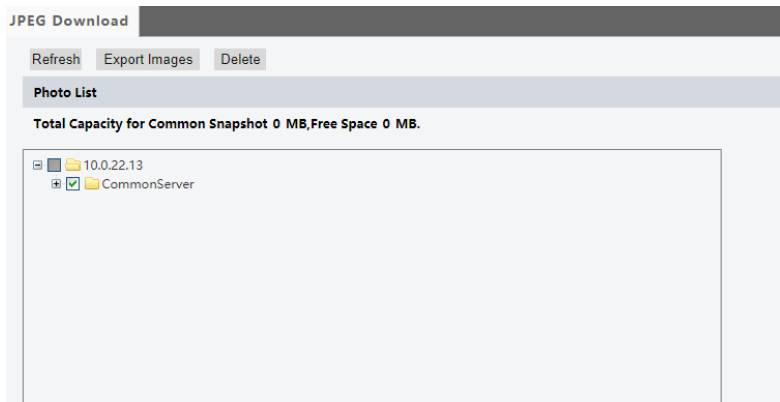

Use Export Images to download snapshots taken by the camera. Refresh the list to update Photo List or Delete to delete images from the selected folder.

Recording Download

Recording download page allows you to search a selected date range for video and snapshots recorded to the microSD card.

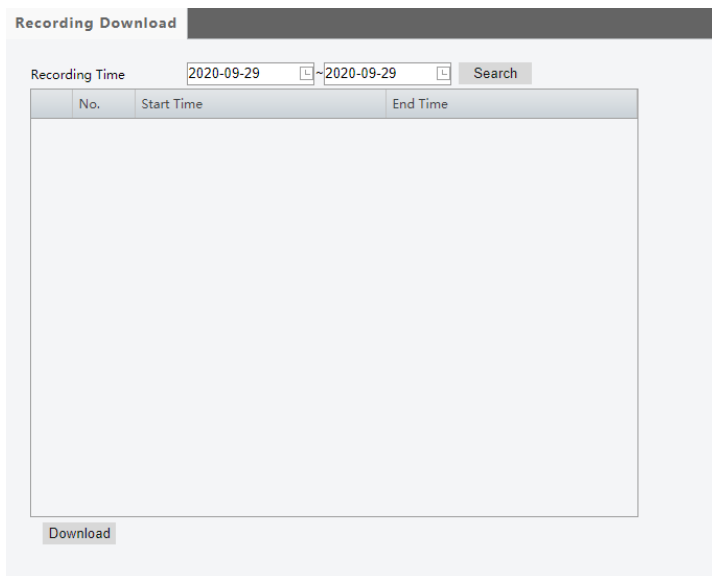

1. Search for video within a specified period. The results will be shown in a list below.
2. Select your video and click **Download**.

SECURITY SETTINGS

User

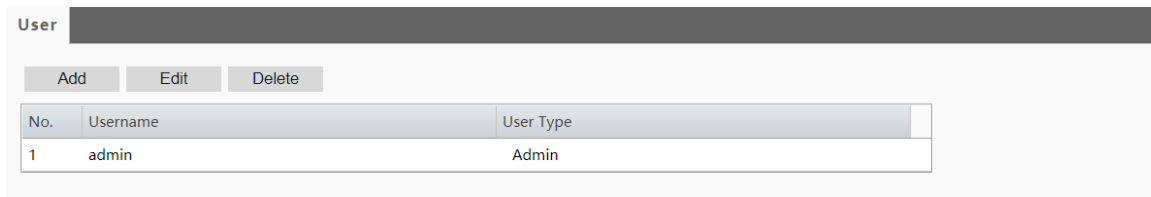

The screenshot shows a user management interface. At the top, there is a header labeled "User" with a dark background. Below the header, there are three buttons: "Add", "Edit", and "Delete". Below the buttons is a table with the following data:

No.	Username	User Type
1	admin	Admin

There are two types of users:

Administrator – referred to as “admin” in this manual. The default name of the administrator is **admin**, which cannot be modified. Admin has full permission and can manage all users and devices. Only one admin user is allowed.

Common User – referred to as “user” in this manual. User only has permission to play live and recorded video.

Up to 20 common users are allowed.

Add

Username and passwords are limited to 32 characters with no spaces permitted. There is a maximum of twenty user accounts.

1. Type the new **Username** and **User Type**.
2. Type a **Password**, and then confirm the password.
3. **Save**

Edit

1. Select the **Username** on the **User list**.
2. Click **Edit**.
3. Modify the password in the resulting window.
4. **Save**

Delete

1. Select the **Username** on the **User list**.
2. Click **Delete** to remove the user.
3. Click **OK** in the confirmation window.

Network Security

HTTPS

You can use the Network Security tab to set a secure channel for data transmission.

The screenshot shows the 'HTTPS' configuration page. At the top, there is a 'HTTPS' tab. Below it, the 'HTTPS' section has a radio button for 'On' (unselected) and 'Off' (selected). The 'Current Certificate' field shows a path: '/CN=192.168.0.1/C=NO/L=NoBrand/ST...'. There are 'Delete' and 'Export' buttons. The 'Certified To' and 'Certified By' fields also show the same path. The 'Valid Period(day)' is '20220206~20230207'. There is an 'Export Certificate' button and a 'Save' button. The 'RTSP Authentication' dropdown is set to 'Digest MD5'. The 'HTTP Authentication' dropdown is also set to 'Digest MD5'. There is a 'Save' button. The 'IP Address Filtering' section has a radio button for 'On' (unselected) and 'Off' (selected). The 'Filtering Mode' dropdown is set to 'Allowlist'. Below this is a table with columns 'No.' and 'IP Address', and a '+' button to add entries. There is a 'Save' button at the bottom.

To configure Network Security:

1. Enable HTTPS by selecting **On**.
2. **Save**

Export Certificate

Click **Export** to download a .crt file of your security certificate.

RTSP and HTTP Authentication

Use the **Authentication** dropdown menus to select the appropriate mode, and then click **Save**.

IP Address Filtering

IP Address filtering allows you to forbid access from specified IP addresses to your camera.

1. Select **On**.
2. Select a **Filtering Mode**, and then click the **+** symbol to add the desired IP addresses to the list.
3. **Save**



Note If the Filtering Mode is set to **Whitelist**, only the specified IP addresses are allowed to access the camera. If the Filtering Mode is set to **Deny Access**, the specified IP addresses are denied access. Up to 32 IP addresses can be added to the list.

Watermark

Use the Video Watermark to encrypt the camera image and protect the video from being deleted or modified.

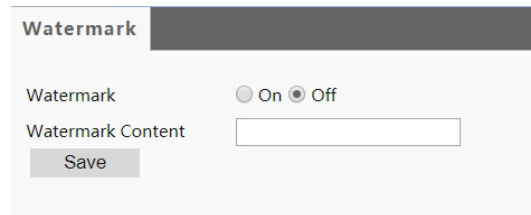

Watermark On Off

Watermark Content

Save

1. Select **On** to enable watermark, and input **Watermark Content**.
2. **Save**

MAINTENANCE

Time

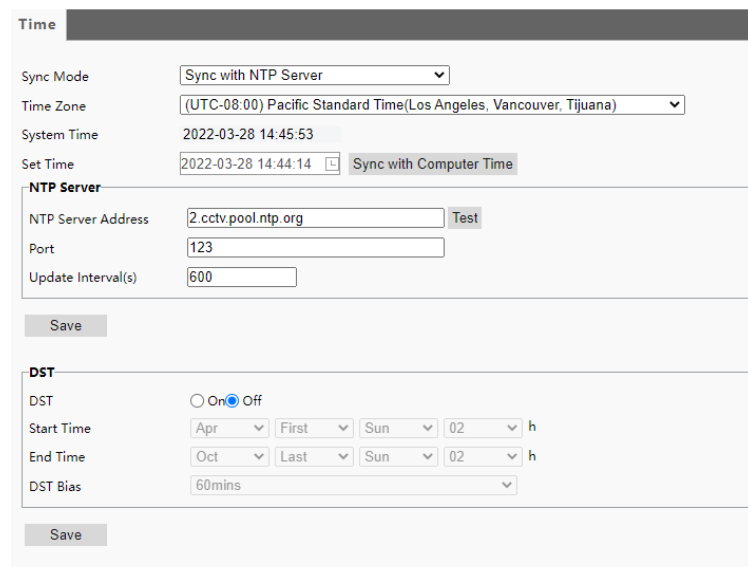

Time

Sync Mode

Time Zone

System Time 2022-03-28 14:45:53

Set Time

NTP Server

NTP Server Address

Port

Update Interval(s)

Save

DST

DST On Off

Start Time h

End Time h

DST Bias

Save

By default, the time setting **Sync Mode** will be set to **Sync with NTP Server**.

Manually Setting or Synchronizing the System Time

1. Select a **Sync Mode**.
2. Set the correct **Time Zone** and **System Time**. You may also click **Sync with Computer Time** to synchronize the time settings of your camera with that of your PC.
3. **Save**

Synchronizing with the NTP Server

1. Set **Sync Mode** to **Sync with NTP Server**, and then set the **NTP Server Address**, **Port** and **Update Interval(s)**.
2. Click **Save**. The camera will periodically synchronize time with the NTP server.

Setting the DST

1. Select **On** for **DST**, set the **Start Time**, **End Time**, and **DST Bias**.
2. **Save**

Maintenance

The screenshot shows a web interface for camera maintenance. It is divided into four main sections: **Software Upgrade**, **Config Management**, **Diagnosis Info**, and **Device Restart**.
- **Software Upgrade**: Includes a 'Local Upgrade' section with a text input field, a 'Browse...' button, and an 'Upgrade' button.
- **Config Management**: Includes a 'Default' button, a checkbox for 'Restore all settings to defaults without keeping current network and user settings.', an 'Importing' section with a text input field, a 'Browse...' button, and an 'Import' button. Below this is an 'Exporting' section with an 'Export' button.
- **Diagnosis Info**: Includes an 'Export Diagnosis Info' button and a checked checkbox for 'Collect Image Debugging Info'.
- **Device Restart**: Includes a 'Restart' button and the text 'Restart device'.

Software Upgrade

To update your camera software, click **Browse**, select the software file, click **Open**, and then click **Upgrade**.



Note The software file must be a .zip file.

Device Restart

This will restart your camera.

Config Management

1. To import configurations that you have backed up, click **Browse**, select the configuration file, and then click **Import**.
2. To export current system configurations, click **Export**.
3. To restore default configurations, click **Default** and then confirm the operation. The device will restart and restore the default configurations. Clicking **Default** with the check box selected will default all camera and camera network settings.

Diagnosis Info

Diagnostic Information includes logs and system configuration. You can export diagnostic information to your PC.



Note Diagnostic information is exported to the local folder as a compressed file. You will need to decompress the file, and then open the file using a text editor.

Network Diagnosis

Configure a diagnostic capture of the camera network to export.



Select NIC: NIC1 (172.30.42.217) ▼

IP Filter: All Specify Filter

Port Filter: All Specify Filter

Custom Rules

Start Capture

1. Select a NIC from the dropdown.
2. Select **All** for all IP Addresses and Ports, **Specify** to enter a specific **Address** or **Port**, or **Filter** to exclude specific IP Addresses and Ports.
3. Check **Custom Rules** to enter additional rules to the diagnosis.
4. **Start Capture**



Note All custom rules must comply with the pcap filter syntax.

Examples:

tcp Capture TCP packets. Other transport layer protocol filter such as UDP, ICMP are also supported.

host 192.168.1.13 Capture packets whose IP is 192.168.1.13.

dst host 192.168.1.13 Capture packets whose destination IP is 192.168.1.13.

src host 192.168.1.13 Capture packets whose source IP is 192.168.1.13.

port 80 Capture packets whose port is 80.

dst port 80 Capture packets whose destination port is 80.

src port 80 Capture packets whose source port is 80.

You can add "not" before an expression to capture all the packets that do not meet the condition. You can also connect expressions with "and" and "or". Example: tcp and dst host 192.168.1.13 and not src port 80 Capture TCP packets whose destination IP is 192.168.1.13 and whose source port is not 80.

Log

The camera's log displays a searchable list of changes made to the system.

Log

Time ~

Main Type

Operation

No.	Type	Date	Time	Username	IP	Description	Result
1	Video & Audio	2021-12-16	13:32:01	admin	172.26.200.252	Configure OSD	Succeeded.
2	Login	2021-12-16	10:03:48	admin	172.26.200.252	Login	Succeeded.

Total 2 . << /1 >>

1. Set a **Time** range.
2. Narrow search by selecting a **Main Type**.
3. Click **Query**.
4. **Export** to download the result.

www.openeye.net
1-888-542-1103

© 2022 OpenEye

All rights reserved. No part of this publication may be reproduced by any means without written permission from OpenEye. The information in this publication is believed to be accurate in all respects. However, OpenEye cannot assume responsibility for any consequences resulting from the use thereof. The information contained herein is subject to change without notice. Revisions or new editions to this publication may be issued to incorporate such changes.