

Network Fixed Dome Cameras

Quick Guide

Safety and Compliance Information

Installation and removal of the unit and its accessories must be carried out by qualified personnel. You must read all of the Safety Instructions supplied with your equipment before installation and operation.

Installation

- This device is a class A product and may cause radio interference. Take measures if necessary.
- Be careful not to blur, scratch, damage the dome cover or leave fingerprints on it because this could decrease image quality. Keep the protective film on the dome cover until installation is complete.
- Make sure the camera operates in an environment where the temperature and humidity meet requirements. Keep the camera from excessive pressure, vibration, moisture, dust, and intensive electromagnetic radiation.
- Use a power adapter or a PoE device that meets requirements. Otherwise, the device may be damaged.
- Make sure the length of the power cable between the power adapter and the camera is not too long, otherwise the voltage of the camera is lowered, causing the camera to work abnormally. If it is required to lengthen the power cable, lengthen the cable between the power adapter and the mains.
- Do not hold the tail cable by hand for weight bearing. Otherwise, the cable connector of the camera could be loosened.
- When connecting to an external interface, use an existing connection terminal, and ensure that the cable terminal (latch or clamp) is in good condition and properly fastened. Ensure that the cable is not tense during mounting, with a proper margin reserved to avoid poor port contact or loosening caused by shock or shake.
- The connectors of the tail cable must not be exposed. The bar cavity, waterproof box, corrugated pipe and PVC pipe must be fully sealed to protect the connectors from water. The waterproof

components for the RJ45 plug must be used properly to protect the network cable from water.

- Make sure the wall or ceiling is strong enough to support the weight of the camera. If dust falls during mounting, take off the dome cover and keep it away from dust. Install the dome cover after the base is installed.
- Purchase a bracket if you need to increase the field of view. Contact your local dealer for details.
- Contact professionals for maintenance information. Do not attempt to dismantle the device by yourself. We shall not assume any responsibility for problems caused by unauthorized repair or maintenance.

Maintenance

- If there is dust on the lens or the transparent dome cover, remove the dust gently using an oil-free brush or a rubber dust blowing ball.
- If there is grease on the lens, remove the grease using lens cleaning cloth gently and then clean the lens in a circular spiral from the center outward using lens cleaning cloth dipped with small amount of cleaning solution. If the grease still cannot be removed, use oil-free cloth or lens cleaning paper and clean the lens gently until it is removed.
- If there is grease or a dust stain on the transparent dome cover, clean the cover gently from the center outward using lens cleaning cloth. If the grease or the stain still cannot be removed, use lens cleaning cloth dipped with detergent and clean the dome cover gently until it is removed.
- Do not use organic solvents, such as benzene or ethanol when cleaning the transparent dome cover.
- Make sure the lens cleaning cloth is clean itself.



- Never look at the transmit laser while the power is on. Never look directly at the fiber ports and the fiber cable ends when they are powered on.
- Use of controls or adjustments to the performance or procedures other than those specified herein may result in hazardous laser emissions.

Regulatory Compliance

FCC statements

This device complies with Part 15 of the FCC Rules. Operation is subject to the following two conditions: (1) this device may not cause harmful interference, and (2) this device must accept any interference received, including interference that may cause undesired operation.

Caution: The user is cautioned that changes or modifications not expressly approved by the party responsible for compliance could void the user's authority to operate the equipment.

Note: This equipment has been tested and found to comply with the limits for a Class A digital device, pursuant to part 15 of the FCC Rules. These limits are designed to provide reasonable protection against harmful interference when the equipment is operated in a commercial environment. This equipment generates, uses, and can radiate radio frequency energy and, if not installed and used in accordance with the instruction manual, may cause harmful interference to radio communications. Operation of this equipment in a residential area is likely to cause harmful interference in which case the user will be required to correct the interference at his own expense.

LVD/EMC Directive



This product complies with the European Low Voltage Directive 2014/35/EU and EMC Directive 2014/30/EU.

WEEE Directive–2012/19/EU



The product this manual refers to is covered by the Waste Electrical & Electronic Equipment (WEEE) Directive and must be disposed of in a responsible manner.

Battery Directive-2013/56/EC



Battery in the product complies with the European Battery Directive 2013/56/EC. For proper recycling, return the battery to your supplier or to a designated collection point.

Default IP, Username and Password

- Default IP address: **192.168.1.13**
- Default username: **admin**



The default password is used for your first login. To ensure account security, please change the password after your first login. You are recommended to set a strong password (no less than eight characters).

Appearance

Dimensions

The following takes the infrared camera as an example. For the actual appearance, see the product.

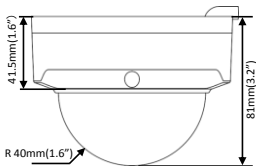
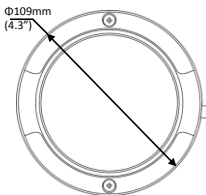

Cable Connection

All the cables are tagged to indicate their functions. This section takes full tail cable as an example. You can connect cables by referring to the following figure.



For specifications, see the latest product datasheets.

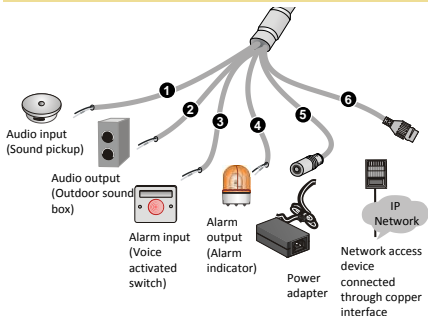

Mount Your Camera

The following takes the infrared camera as an example. For the actual appearance, see the product.

Ceiling Mount

1. Locate the positions of the holes.

Paste installation positioning stickers on the ceiling and lead the cables through the hole on the wall.



Explosion-proof model



Plastic model

2. Drill holes on the wall.

Use a $\varnothing 6-6.5$ mm drill bit to drill 30 mm-depth guide holes according to the positions marked by stickers.

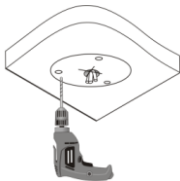
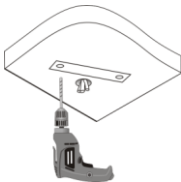

3. Mount the plastic rivets of self-tapping screws.

Knock the plastic rivets into the guide holes and ensure that they are tightened up.

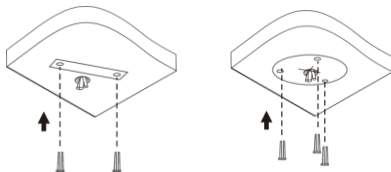

4. Mount the camera.

Connect all cables of the ceiling and the camera, lead self-tapping screws through the guide holes in the camera base, and fix the camera on the ceiling by using a screwdriver.

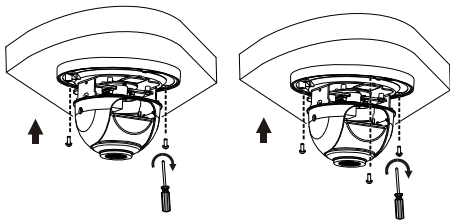

5. Adjust the monitoring direction of the lens (tighten screws after vertically adjusting the lens).

The lens can horizontally turn by rotating the lens base, as shown by ❶ in the following figure. After loosening the fastening screws, you can vertically turn the lens, as shown by ❷ in the following figure.

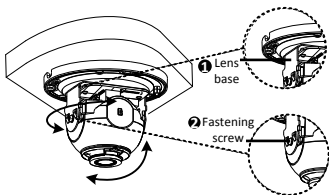

6. Attach the lining and lock it into the buckle on the base.

The following shows the installation instructions of cameras 2-Axis and 3-Axis. The linings are different. Please see the actual products for the differences.

2-Axis:

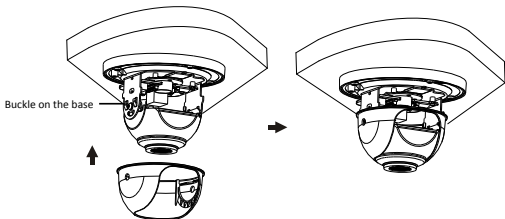

3-Axis:

For 3-Axis, after adjusting the lens horizontally and vertically (see step 5), you can also rotate the lens clockwise or counterclockwise to get the desired monitoring direction. Please stop rotating the camera when the lens is blocked, otherwise the camera lens might be damaged.

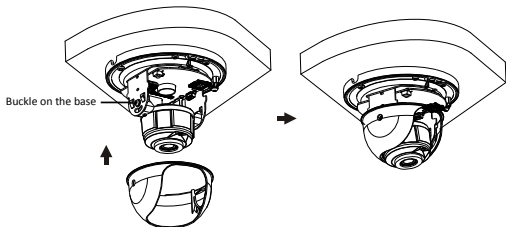

You can also insert the Micro SD card directly as shown in the figure below. Do not hot plug the Micro SD card after it is inserted. Otherwise the camera or the Micro SD card might be damaged.

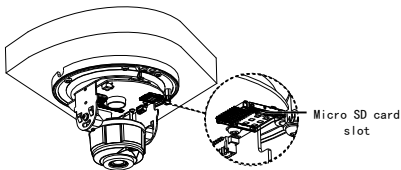

7. Mount the transparent dome housing.

- a. Align the screw holes in the base, and tighten the two cross-recessed pan-head screws on the edge of the transparent dome housing to fix it, as shown by ❶ in the following figure.
- b. Align the grooves (non-tail cable grooves) of the transparent dome housing to the buckle of the base, and push up the dome housing to fix it, as shown by ❷ in the following figure.

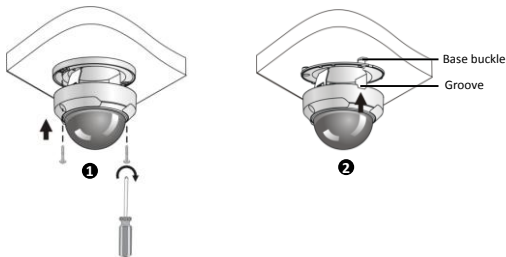

- The preceding installation process is concealed installation, during which holes are drilled in the ceiling and tail cable is led out from the top of the camera. Cables are connected and frapped at the ceiling side to prevent messy cables from affecting camera mounting. If open installation is adopted, tail cable is led out from one side of the camera

and can be routed from the side groove of the camera.

- After mounting the dome housing, check that the two cross-recessed pan-head screws on the edge of the dome housing are tightened up to ensure that the camera is properly sealed. For details, see *Mount the transparent dome housing*.

Waterproof Components for an RJ45 Plug

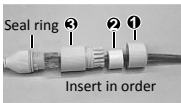

Attach the seal ring to the Ethernet interface. Mount the waterproof components in order. Then insert the cable into the Ethernet interface and screw the waterproof bolt in.



You can crimp the inner wires of the cable with the RJ45 plug first and then cover the waterproof components. You may also cover the waterproof components first.



- Avoid short circuit when insulating the cables.
- Use self adhesive waterproof tapes that will stick together with the twisted cables.
- Tighten waterproof tapes when wrapping the

cables and make sure the cable connections are fully covered.

- You are recommended to put the waterproof cables in a waterproof junction box which needs to be purchased separately.

Access Your Camera

Before you begin, check that:

- Your camera is operating properly and connected to the network.
- The PC you are using is installed with Internet Explorer 7.0 or later.

Follow these steps to access your camera through the Web:

1. Open your browser, input the IP address of your camera in the address bar and then press **Enter** to open the login page.
2. Enter the username and password and then click **Login**.



- Install the ActiveX at your first login. When the installation of the ActiveX is completed, open your IE to log in.
- For your first login with Windows 7, if the system does not prompt you to install ActiveX, follow these steps to turn off UAC: click the **Start** button, and then click **Control Panel**. In the search box, type **uac**, and then click **Change User Account Control Settings**. Move the slider to the **Never**

Notify position, and then click **OK**. After UAC is turned off, log in again.

- If the installation failed, open **Internet Option** in IE before login. Click the **Security** tab, click **Trusted sites**, and then click **Sites** to add the website. If you use Windows 7, you need to save the setup.exe to your PC first, and then right-click the file, select **Run as administrator**, and then install it according to instructions.