

AIPHONE®

GT SYSTEM

Multi Building System

INSTALLATION MANUAL

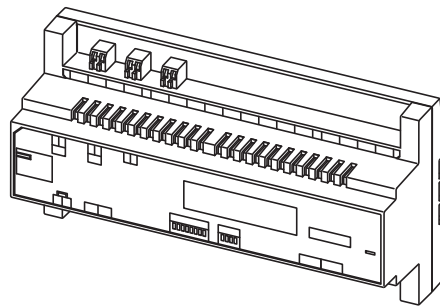

This manual explains how to install the multi-building control unit **GT-MCX**. Refer to the installation manual for the **GT SYSTEM/Standard & Expanded System** for installing the other GT system products.

The following manuals (in multi languages) of the GT system are also available from our website <https://www.aiphone.net/>.

* The site can be accessed directly by reading the QR code on the right.

- Operation manual
- Installation manual
- Setting manual
- Quick start installation guide
- Aiphone GT Setup Tool for Windows

[QR code]



Thank you for selecting Aiphone for your communication needs. Please read this manual carefully before installation, and keep this in a safe place for future reference.

The illustrations used in this manual may differ from the actual items.

PRECAUTIONS

 Prohibited

 Do not dismantle unit

 Keep unit away from water

 Be sure to follow the instruction

WARNING

(Negligence could result in death or serious injury.)

- ⊘ 1. Do not dismantle or alter the unit. Fire or electric shock could result.
- ⊘ 2. Do not connect any power source other than specified to terminals +, - nor install two power supplies in parallel to single input. Fire or damage to the unit could result.
- ⊘ 3. Do not connect any terminal on the unit to AC power line. Fire or electric shock could result.
- ❗ 4. For power supply, use Aiphone power supply model or model specified for use with system. If non-specified product is used, fire or malfunction could result.
- ⊘ 5. Voltage is applied to parts within the equipment. Do not touch any parts that are not associated with the installation, wiring, or connection. Electric shock could result.
- ❗ 6. If any abnormality (i.e., smoke, unusual smell or unusual noise) is sensed from the unit, or the unit falls or gets broken, unplug the unit or turn off the breaker immediately. Fire or electric shock could result.

CAUTION

(Negligence could result in injury to people or damage to property.)

- ⊘ 1. Do not install or make any wire terminations while power supply is plugged in. It can cause electrical shock or damage to the unit.
- ❗ 2. Before turning on power, make sure wires are not crossed or shorted. Fire or electric shock could result.
- ❗ 3. When mounting the unit on wall, install the unit in a convenient location, but not where it could be jarred or bumped. Injury could result.
- ⊘ 4. Do not install the unit in locations subject to frequent vibration or impact. It may fall or tip over, resulting in damage to the unit or personal injury.
- ❗ 5. Be sure to perform a call test or check the chime volume with the handset on the hook. If you operate the hook switch with the handset on your ear, a sudden call etc. may cause damage to your ear.
- ⊘ 6. Do not place your ear close to the speaker during use as it could cause hearing damage.

Precautions for mounting

1. Observe the following restrictions for mounting entrance stations.
 - Do not mount the entrance station so that it faces obliquely upward. The rain water may go inside and it may damage the unit.
 - Do not block the bottom of entrance station by caulking.
2. Do not install the unit in any of the following locations. Fire, electric shock, or unit trouble could result.
 - Places under direct sunlight.
 - Places near heating equipment or a boiler that varies in temperature.
 - Places where dust, oil, chemicals or hydrogen sulfide are present.
 - Places where moisture and humidity extremes are present, such as bathrooms, cellars, greenhouses, etc.
 - Places where the temperature is quite low, such as inside a refrigerated area or in front of an air conditioner.
 - Places with steam or smoke (near heating or cooking surfaces).
 - Places subject to sulfur, such as hot springs.
 - Places near the shore or exposed to the direct sea breeze.
3. Do not install this unit in any of the following locations where lighting or the ambient environment could impact the display on the video monitor due to the characteristics of the door station's camera.
 - Locations where is bright as the sky is shown widely behind the caller
 - There is a white wall behind the caller
 - Locations subject to direct sunlight or strong lighting
4. When using a fluorescent light that shines around the camera in the 50Hz area, the screen colors may variously change as color rolling or flickering. Please block off the light or use the inverter fluorescent lamp.
5. For running cables, separate them for audio/video and door release and keep them more than 10cm (3-15/16") away from each other.
6. When using an existing wiring, depending on the type of wiring, it may not operate the system. Please check and change it in advance.
7. Do not use the impact driver for mounting. Damage to the unit could result.

General Precautions

1. Keep the intercom wires more than 30cm (12") away from AC 100-240V wiring. AC induced noise and malfunction could result.
2. When installing and using the system, please consider the privacy and portrait rights of users and visitors. Aiphone shall not be held responsible for violation or privacy or other statutory rights. (The protection of privacy and statutory rights is the responsibility of the customer.)
3. Install the units, which will not be operated, in an area that will be accessible for future inspections, repairs, and maintenance.
4. Be sure to install an entrance station vertically. If it is installed horizontally, rainwater may get into the unit causing a malfunction.
5. For maintenance or after-sales service, make sure to provide the setting data to the customer.
6. Do not put an obstacle such as a foliage plant where monitoring is done by a human body detection sensor.

Notices

- Do not install the unit close to an electrical appliance or water heater using a dimmer or inverter, a remote controller of floor heating, etc. Failure to do so may generate a noise causing a malfunction of the unit.
- In areas where broadcasting station antennas are close by, intercom system may be affected by radio frequency interference.
- When warm indoor air flows into the unit, dew condensation may be caused by a temperature difference between indoors and outdoors. It is recommended to cover openings on the unit such as cable incoming holes to avoid condensation.
- Using a mobile phone or professional-use radio equipment such as walkie-talkie close to the system may cause a malfunction.

Table of Contents

PRECAUTIONS	2
1 SYSTEM CONFIGURATIONS	
1-1 Application examples.....	4
1-2 Multi building consisting of standard systems.....	5
1-3 Multi building consisting of expanded systems.....	6
1-4 Wiring distance	8
2 COMPONENTS	9
3 MOUNTING	
3-1 Cables.....	10
3-2 Mounting the multi-building control unit GT-MCX.....	11
4 WIRING	
4-1 Multi building consisting of standard systems.....	12
4-2 Multi building consisting of expanded systems.....	16
5 SWITCH SETTINGS	20
6 CHECK FOR INSTALLATION	22
6-1 Finding a proper "grounding point" for power supply.....	22
6-2 Checking "ground fault" with tester.....	23
REGULATIONS	Back cover
WARRANTY	Back cover

1 SYSTEM CONFIGURATIONS

The GT system can be configured over an IP network so multiple buildings can be connected and controlled centrally as a large-scale system. There can be a maximum of 5,000 residential/tenant stations in the system.

A multi building system consists of tenant and main sections, and a section consists of a standard or expanded system. All sections can be configured via IP network connection.

Tenant section: Tenant section consists of residential/tenant stations. One multi building control unit, GT-MCX, is needed per section. Up to 24 tenant sections can be set up in the same system. One tenant section can support up to 500 residential/tenant stations.

Main section: Main section consists of main entrance stations and main guard stations. One multi building control unit, GT-MCX is needed per section. Up to 8 main sections can be set up in the same system.

* A main section cannot include residential/tenant stations.

* A modular type entrance station cannot be included in a main section.

Not available in main section



1-1 Application examples

Example 1 : Multiple buildings

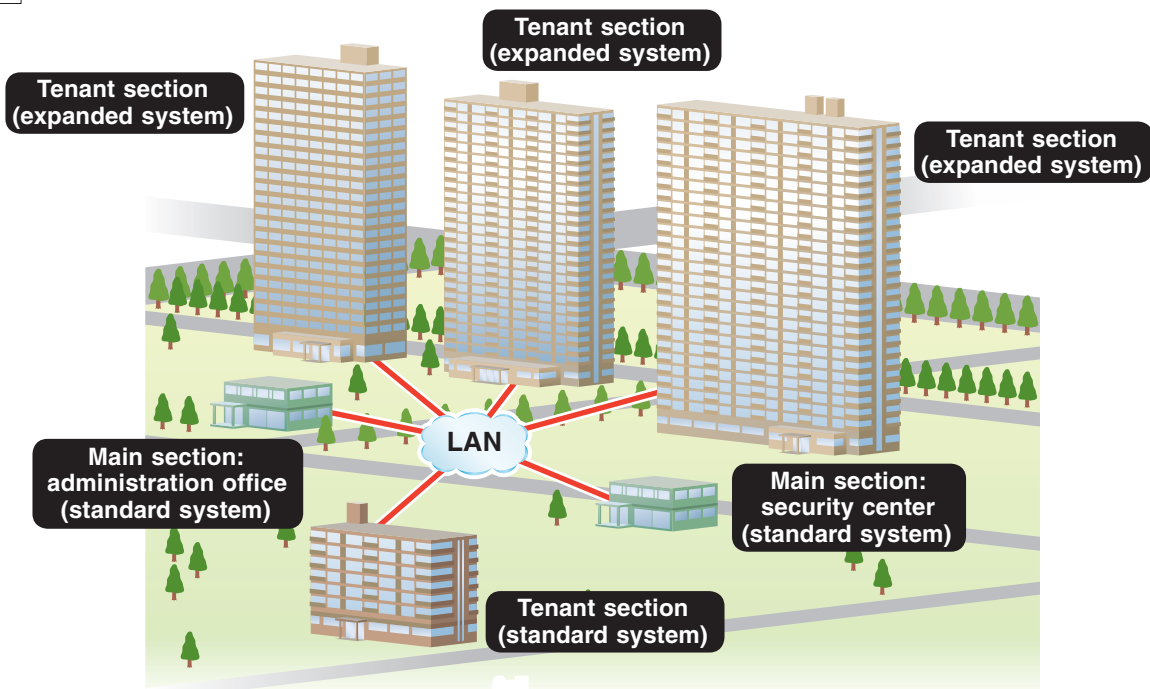

Example 2 : Large-scale single building

A multi building system can be applied to a large-scale single tenant building that includes more than 500 residential/tenant stations.

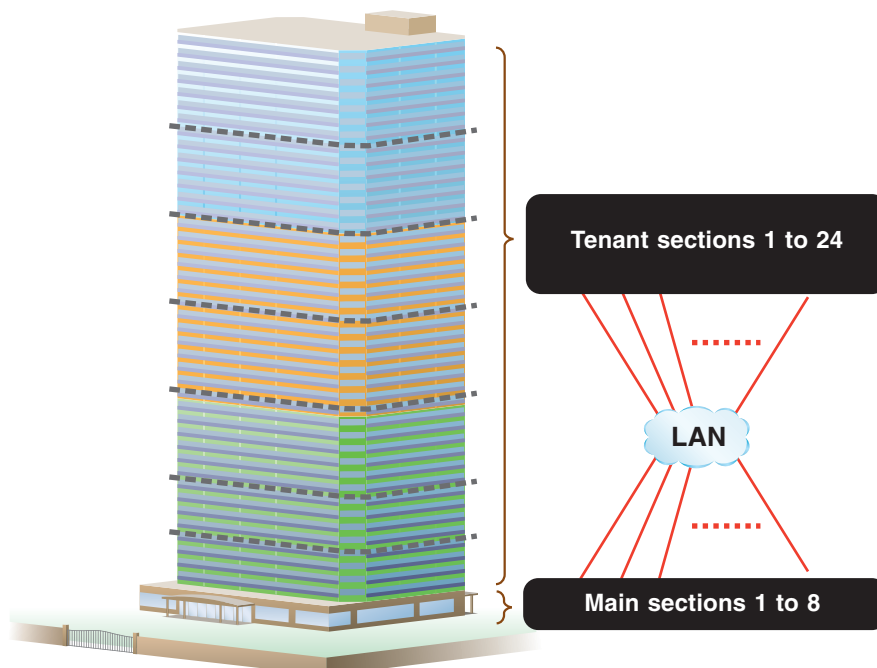

1-2 Multi building consisting of standard systems

The following is a multi building system configuration example that consists of standard systems as tenant and main sections. Refer to the installation manual **GT SYSTEM/Standard & Expanded System** for details about the standard system configuration.

*Refer to section 4 "WIRING" for details about wiring and connection.

Tenant section (standard system)

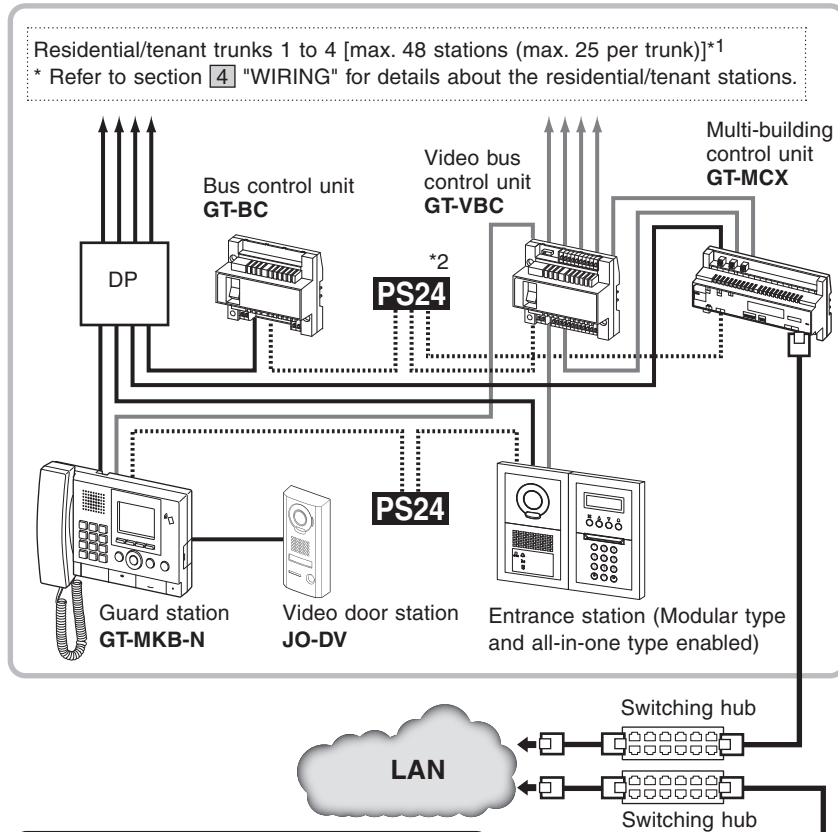

Main section (standard system)

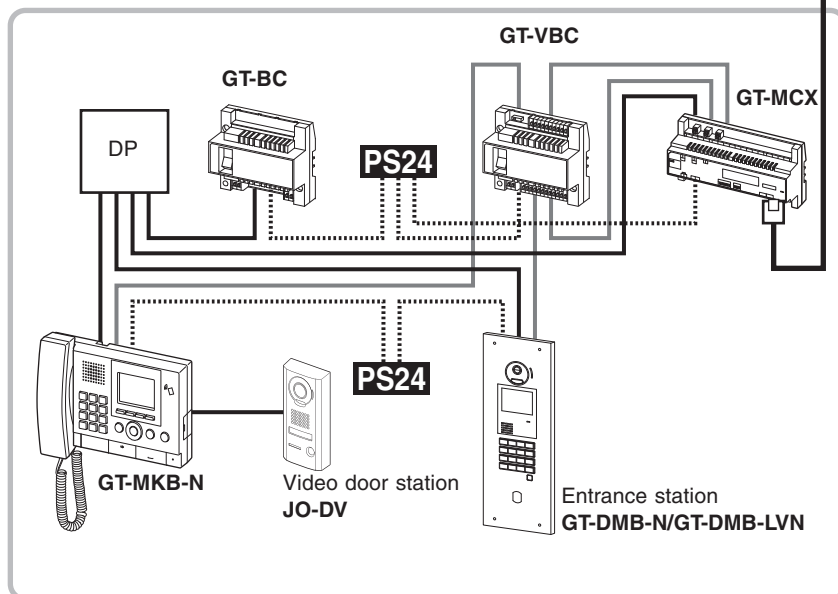

PS24 Power supply

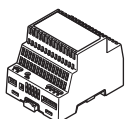

PS-2420DM



PS-2420
 PS-2420S
 PS-2420UL
 PS-2420BF

- : Audio signal line
- : Video signal line
- : Power supply line

☐—☐ : CAT5e/6 cable (100BASE-TX)

DP: Distribution Point
 (Not provided by Aiphone except for Europe and North America.)

*1: Refer to Standard & Expanded System Manual about residential/tenant station configurations.

*2: Make sure that a power supply is shared between GT-BC and GT-VBC.

Tenant section (standard system)

Capacity: Max. 24 sections

Device	Capacity (per section)
Entrance station	Max. 4 (max. 3 per trunk from the DP) *3 *4
Guard station (GT-MKB-N)	Max. 1
Residential/tenant station	Max. 48 (max. 25 per trunk from the DP) *5
Residential/tenant stations in the same residence/tenant	Max. 4 *6
4-way video junction unit (GT-4Z)	Max. 6 per trunk
Bus control unit (GT-BC)	1 required
Video bus control unit (GT-VBC [STD])	Max. 1
Sub residential/tenant station (GT-2H-L, GT-2H)	Max. 3 (connectable to the residential/tenant station GT-2C only)
Multi-building control unit (GT-MCX)	1 required

*3: If GT-DB-V, GT-DB-VN or an external door release button is connected to an entrance station that includes GT-SW, a maximum of 3 entrance stations can be connected to the system.

*4: Up to 3 entrance stations can be connected per audio signal line from the DP. If GT-DB-V or GT-DB-VN is used in an entrance station, the maximum number of entrance stations is 2.

*5: The maximum is 100 stations with GT-1D only. (GT-1D: Max. 50 stations per trunk)

*6: Max. 4 under the following conditions only:

- GT-1A or GT-1D × Max. 4
- GT-1C7(-L) × 1 + GT-1A or GT-1D × Max. 3
- GT-1M3(-L) × 1 + GT-1A or GT-1D × Max. 3
- GT-1M3(-L) × 2 + GT-1A or GT-1D × Max. 2
- GT-2C(-L) × Max. 4
- GT-1C7W(-L) × Max. 4 (Register a wireless LAN router to only one GT-1C7W(-L) in the same residence/tenant.)

Main section (standard system)

Capacity: Max. 8 sections

Device	Capacity (per section)
Entrance station (GT-DMB-N or GT-DMB-LVN) *7	Max. 4 (max. 3 per trunk from the DP) *3 *4
Guard station (GT-MKB-N)	Max. 1
Bus control unit (GT-BC)	1 required
Video bus control unit (GT-VBC [STD])	Max. 1
Multi-building control unit (GT-MCX)	1 required

*7: Only all-in-one type entrance stations can be used in a main section.

Modular type entrance stations cannot be used.

1-3 Multi building consisting of expanded systems

The following is a multi building system configuration example that consists of expanded systems as tenant and main sections. Refer to the installation manual **GT SYSTEM/Standard & Expanded System** for details about the expanded system configuration.

* Refer to section 4 "WIRING" for details about wiring and connection.

*1: Refer to Standard & Expanded System Manual about residential/tenant station configurations.

*2: Make sure that a power supply is shared between GT-BC and GT-VBC (STD). Also, a power supply must not be shared between trunk lines (including sub and common trunk lines).

*3: Make sure that a power supply is shared between GT-BCXB-N and GT-VBC.

Tenant section (expanded system)

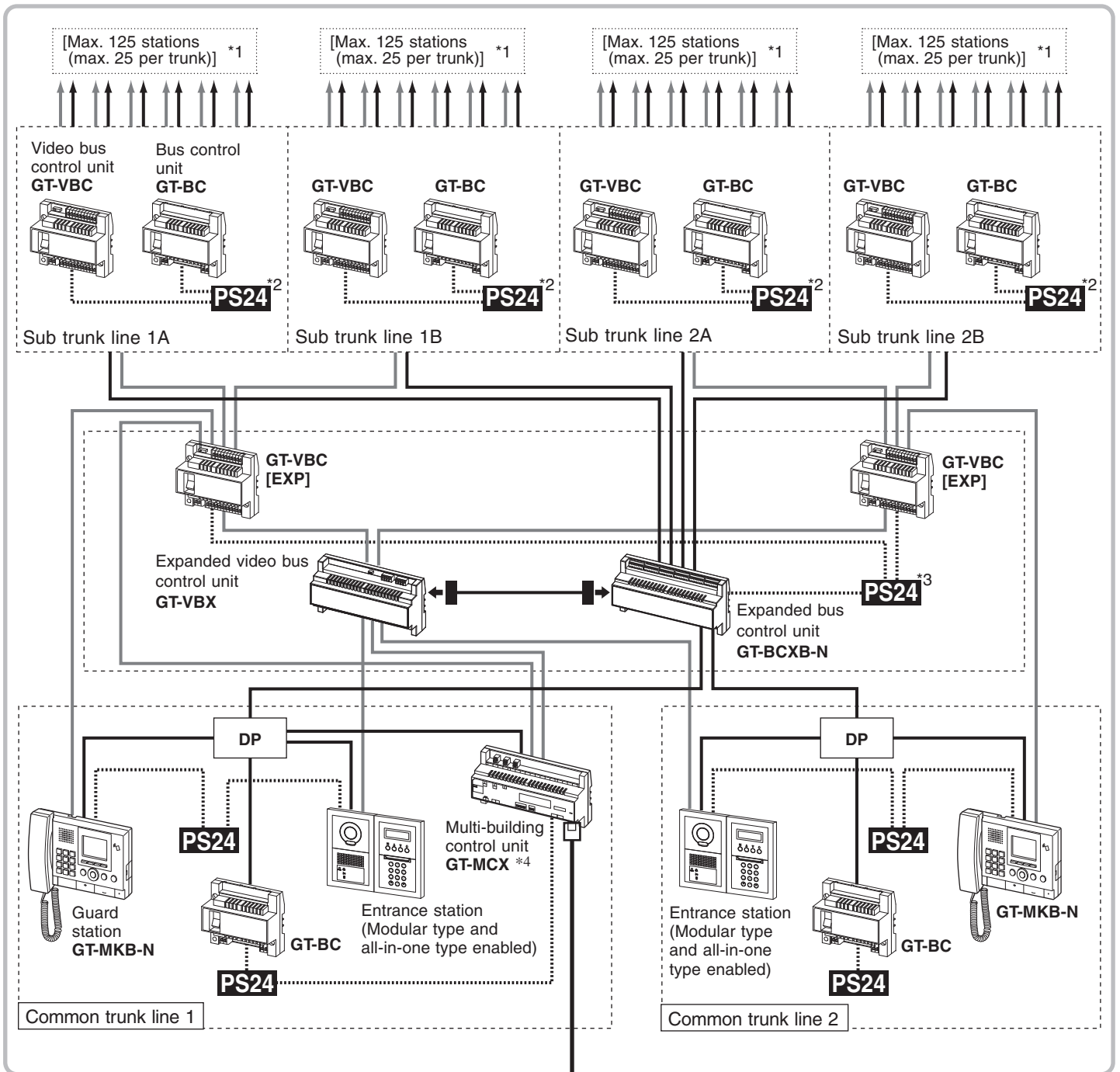

*4: The multi-building control unit GT-MCX must be connected to common trunk line 1.

Tenant section (expanded system)

Capacity: Max. 24 sections

Device	Capacity (per section)
Entrance station	Max. 15 (Common trunk line 1: max. 7, Common trunk line 2: max. 8)
Residential/tenant station	Max. 500 *5
Residential/tenant stations per sub trunk line	Max. 125 (max. 25 per trunk) *6
Guard station (GT-MKB-N)	Max. 3 (Common trunk line 1: max. 1, Common trunk line 2: max. 2)
Residential/tenant stations in the same residence	(Same as standard system)
Bus control units per common trunk line (GT-BC)	1 required
Bus control units per sub trunk line (GT-BC)	1 required
Sub residential/tenant station (GT-2H-L, GT-2H)	(Same as standard system)

*5: This includes guard stations connected to the entrance stations by the Hand-shaking link setting.

*6: Max. 50 per trunk when using GT-1D only for residential/tenant stations.

Main section (expanded system)

Capacity: Max. 8 sections

Device	Capacity (per section)
Entrance station (GT-DMB-N or GT-DMB-LVN) *7	Max. 15 (Common trunk line 1: max. 7, Common trunk line 2: max. 8)
Guard station (GT-MKB-N)	Max. 3 (Common trunk line 1: max. 1, Common trunk line 2: max. 2)
Bus control units per common trunk line (GT-BC)	1 required

*7: Only all-in-one type entrance stations can be used in a main section. Modular type entrance stations cannot be used.

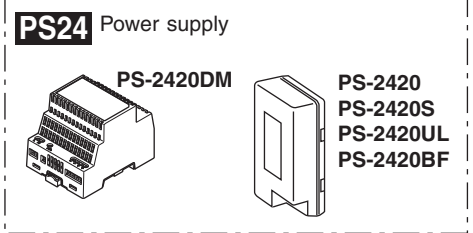

Main section (expanded system)

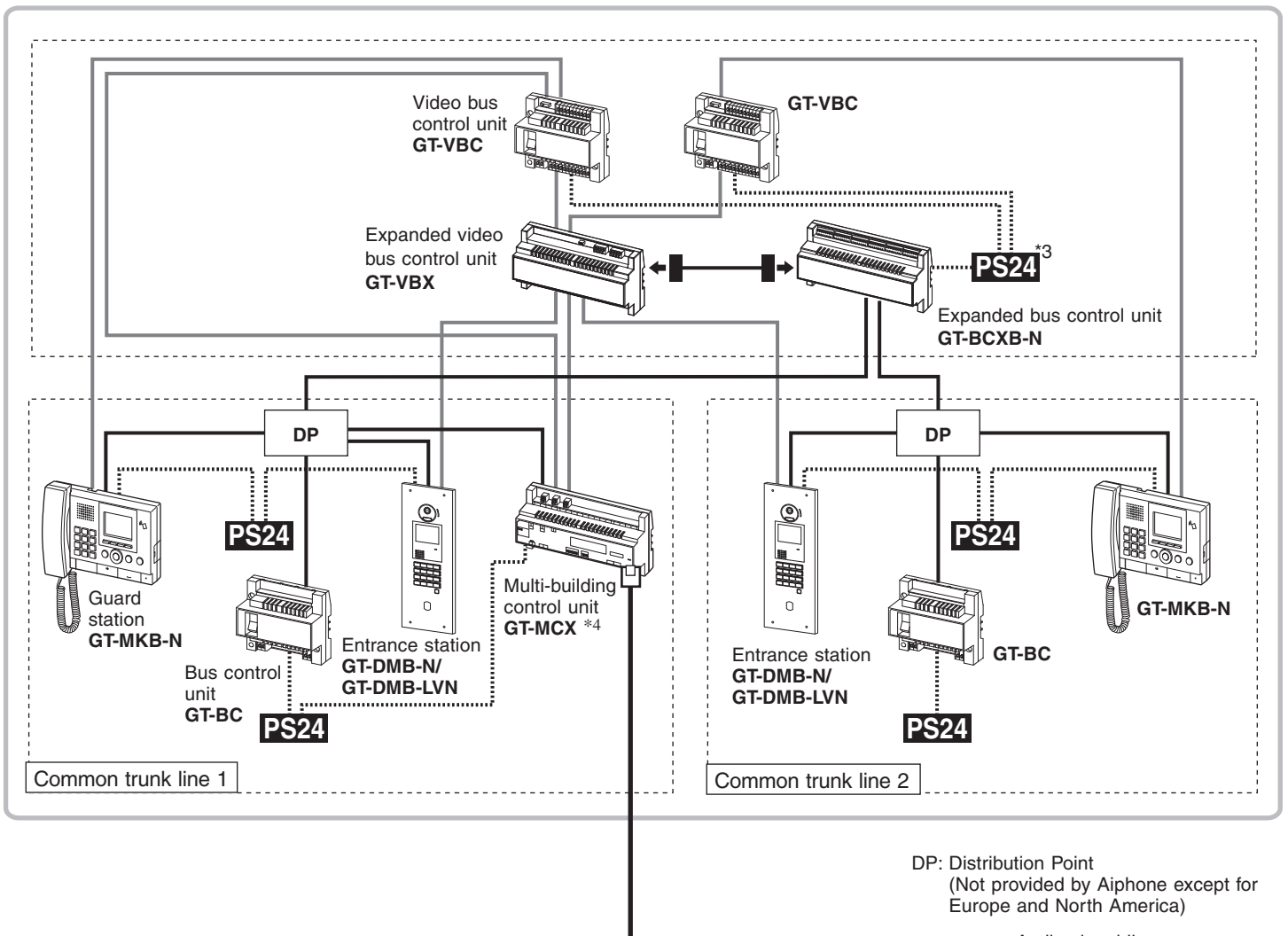

DP: Distribution Point
(Not provided by Aiphone except for Europe and North America)

- : Audio signal line
- : Video signal line
- : Power supply line
- : CAT5e/6 cable (100BASE-TX)

1-4 Wiring distance

The following diagrams show the wiring distances between the multi-building control unit **GT-MCX** and main section devices only. Refer to the installation manual **GT SYSTEM/Standard & Expanded System** for wiring distances between residential/tenant stations.

Standard system

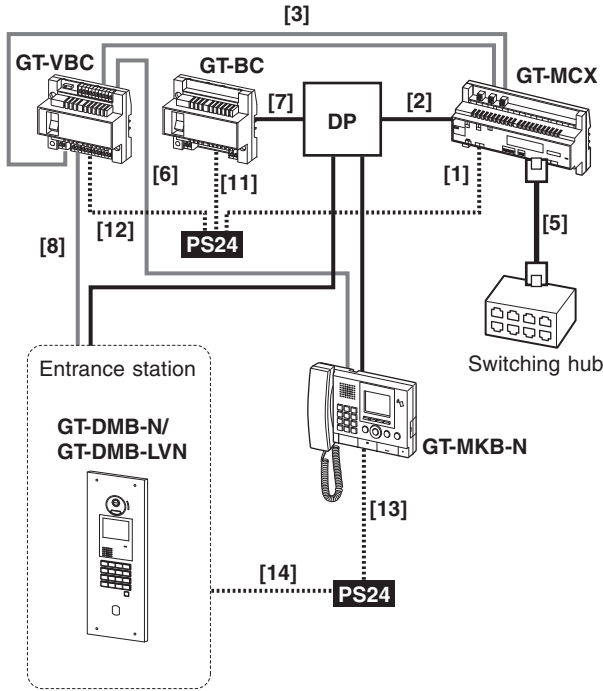

Expanded system

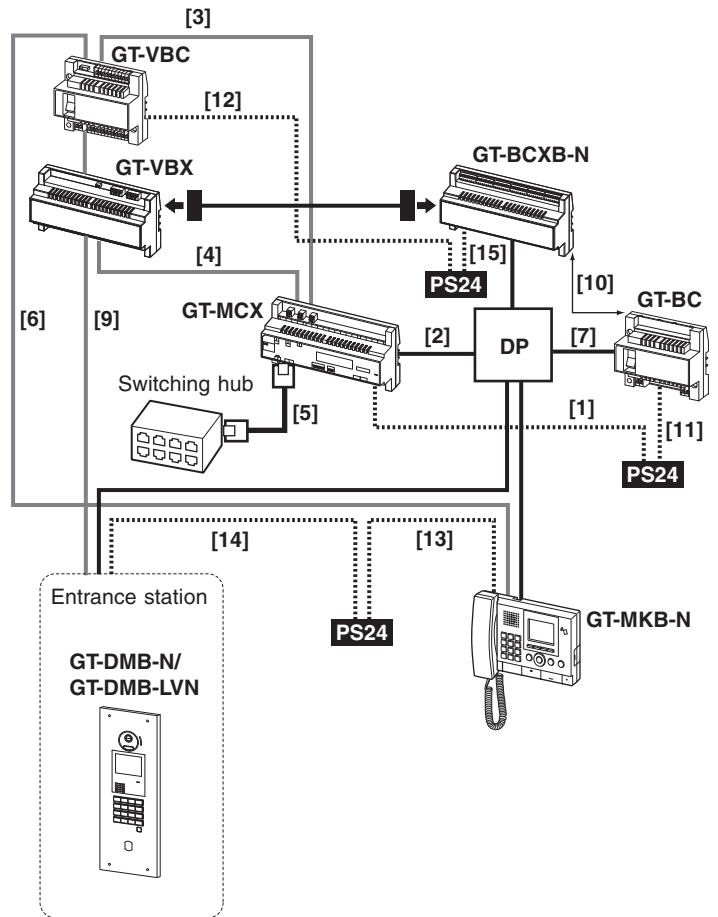

Wiring distance		Wire diameter	0.65 mm (22 AWG)	0.8 mm (20 AWG)	1.0 mm (18 AWG)
[1]	GT-MCX - power supply		3 m (10')	5 m (16')	5 m (16')
[2]	GT-MCX - DP *1		50 m (165')	50 m (165')	50 m (165')
[3]	GT-MCX - GT-VBC		50 m (165')	50 m (165')	50 m (165')
[4]	GT-MCX - GT-VBX		50 m (165')	50 m (165')	50 m (165')
[5]	GT-MCX - switching hub	CAT5e/6 cable 100 m (330') *2			
[6]	GT-VBC - farthest GT-MKB-N		100 m (330')	150 m (490')	150 m (490')
[7]	GT-BC - DP *1		3 m (10')	5 m (16')	5 m (16')
[8]	Entrance station - GT-VBC		150 m (490')	300 m (980')	300 m (980')
[9]	Entrance station - GT-VBX		150 m (490')	300 m (980')	300 m (980')
[10]	GT-BCXB-N - GT-BC		150m (490')	300 m (980')	300 m (980')
[11]	GT-BC - power supply *3		3 m (10')	5 m (16')	5 m (16')
[12]	GT-VBC - power supply *3		3 m (10')	5 m (16')	5 m (16')
[13]	GT-MKB-N - power supply *3		100 m (330')	150 m (490')	150 m (490')
[14]	Entrance station - power supply *3		150 m (490')	300 m (980')	300 m (980')
[15]	GT-BCXB-N - power supply *3		3 m (10')	5 m (16')	5 m (16')
Audio only main section audio [R1, R2] total wiring distance per common line (maximum 2 "common" trunk lines)			1650 m (5400')	2500 m (8200')	2500 m (8200')

*1: DP = Distribution Point (Not provided by Aiphone except for Europe and North America.)

*2:  Do not route a CAT5e/6 cable outdoors from a multi-building control unit directly. When routing a CAT5e/6 cable outdoors from a switching hub, use a model that supports outdoor wiring.

*3: When powering two or more devices with one power supply, separate the cables near the power supply.

2 COMPONENTS

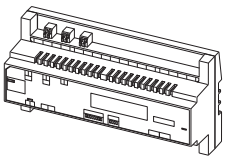

Multi-building control unit
GT-MCX

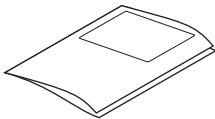

English, French installation manual (this manual)

* A mounting bracket is attached to the product.

* GT-MCX includes the Chinese RoHS paper.

3 MOUNTING

3-1 Cables

- Use PE (polyethylene)-insulated PVC jacket cable.
Parallel or jacketed 2-conductor, mid-capacitance non-shielded cable is recommended.
- Never use individual conductors, twisted pair cable or coaxial cable.

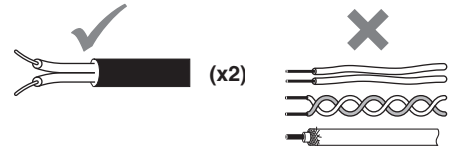

To connect low voltage wires, either crimp them with a crimp sleeve or solder them, and then insulate by covering with insulating tape.

[Crimping with a crimp sleeve]

1. Line up solid and stranded conductors, and crimp them.

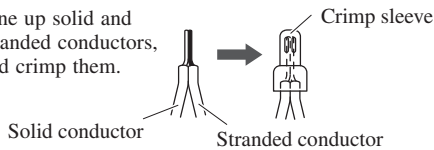

2. Overlap more than half of the width and twist them at least twice.

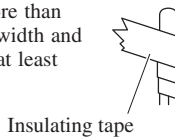

[Soldering]

1. Twist the stranded conductor around the solid conductor at least three times.

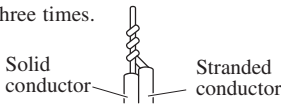

2. Bend the tip and solder it. Make sure no lead wire sticks out.

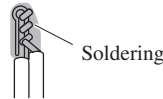

3. Overlap more than half of the width and twist them at least twice.



! Keep the number of connections as low as possible when wiring.

After connecting wires, make sure to check for breaking or insufficient connection. Especially when connecting a wire in the middle of wiring, either crimp it with a crimp sleeve or solder it, and then insulate it by covering with an insulating tape.

Just twisting wires may cause poor connection, or the surface of the wires may get oxidized to cause a loose connection, leading to malfunctioning or failure.



Soldering
Crimping with a crimp sleeve

NOTES:

- If the lead wire with a connector is short, extend it using an interconnecting cable.
- Connectors have polarity, so pay attention and connect properly. If connected incorrectly, the device won't work.

Notes on CAT5e/6 cables (for Ethernet LAN connection)

- Do not bend the cables to an extent where the radius is less than 25 mm (1"). Communication failure could result.

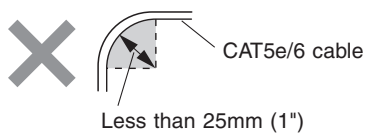
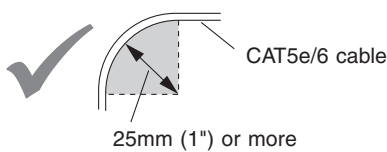

- Do not remove the CAT5e/6 cable jacket more than necessary.

- Arrange the color code of the RJ45 connections in accordance with EIA/TIA-568A or 568B.

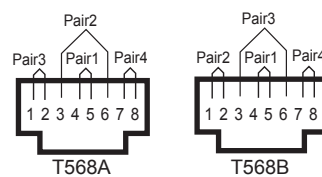

- Be sure to check the condition of cable connections with a LAN checker before connecting with a LAN cable.
- An RJ45 connector with a cover cannot be connected to the port for CAT5e/6. Use a cable without a cover.

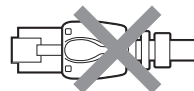

- Do not pull or put excess strain on CAT5e/6 cables.
- Use a straight-through cable for connecting units.

⚠ Do not route a CAT5e/6 cable outdoors from a multi-building control unit directly. When routing a CAT5e/6 cable outdoors from a switching hub, etc., use a model that supports outdoor wiring.

3-2 Mounting the multi building control unit GT-MCX

- 1 Mount the unit on the included DIN rail. Click the unit into place.
- 2 When removing the unit, pull the lock release lever down.

⚠ The GT-MCX cannot be mounted directly to a wall surface.

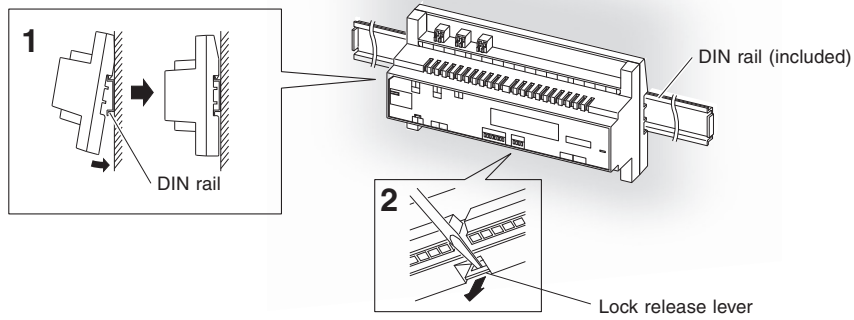

4 WIRING

4-1 Multi building consisting of standard systems

The following is a connection diagram example of a multi building system consisting of standard systems as tenant and main sections.

* The wiring methods differ depending on the equipment used. Refer to the installation manual **GT SYSTEM/Standard & Expanded System** sections 4-2 to 4-4 for the detailed wiring diagrams of entrance stations, guard stations, and residential/tenant stations.

⚠ Each pair of wires should be in a separately jacketed cable (audio, video, and power wiring).

⚠ To prevent shorts, unused cables should be insulated.

Tenant section (standard system)

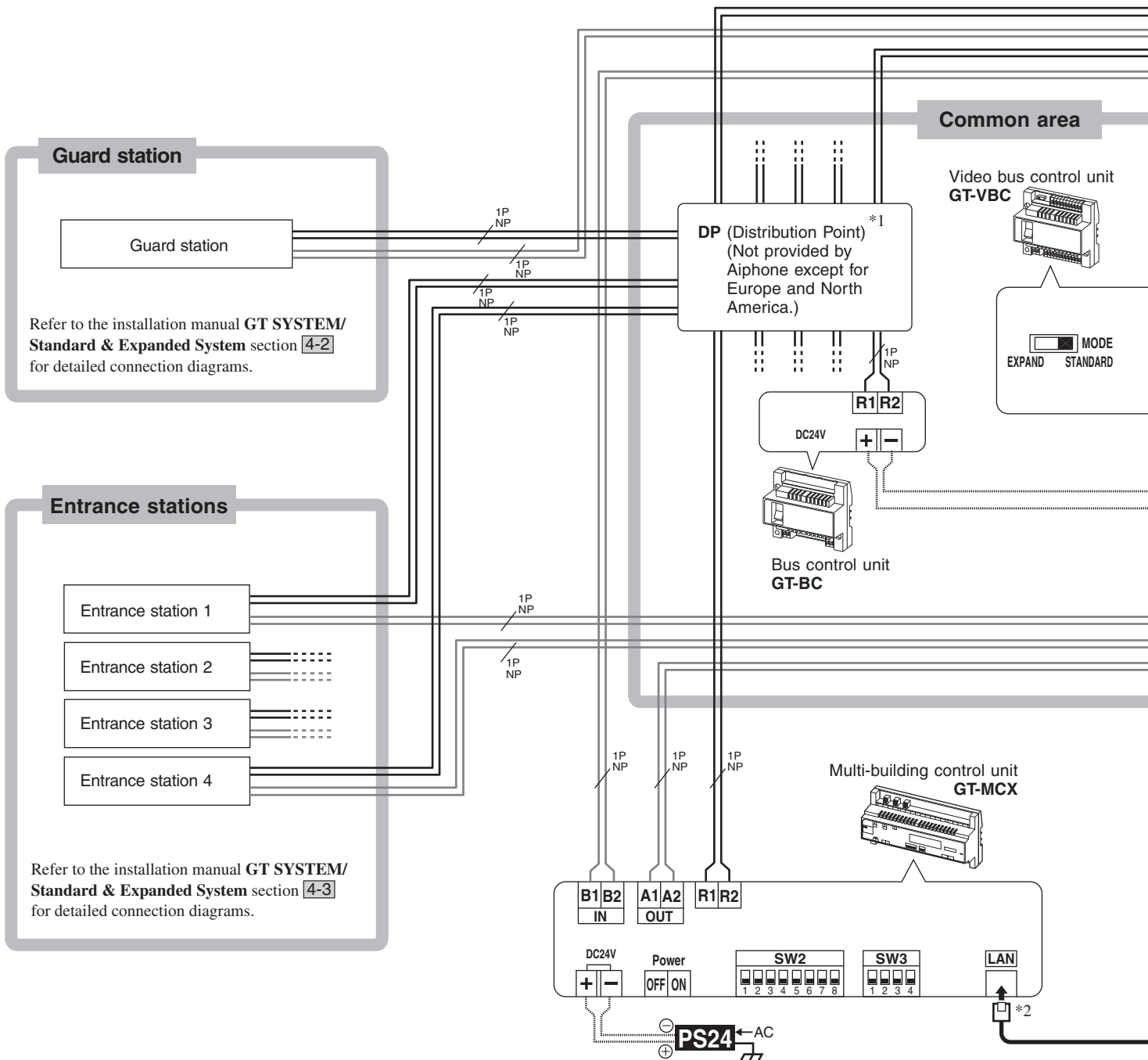

NOTES:

- Do not use the unused terminals and ports for other purposes.
- In order to prevent miswiring, label both ends of each cable with the unit and terminal names to which they are to be connected.
- For connecting other manufacturers' products, refer to the instruction manuals for those products.

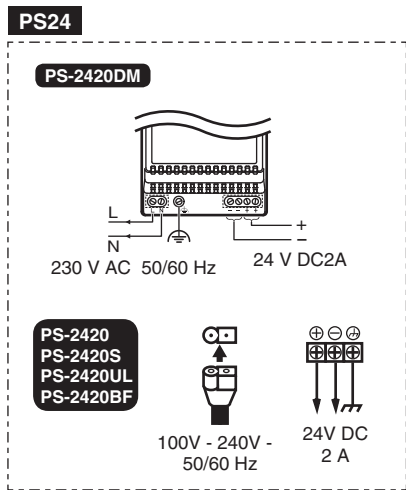
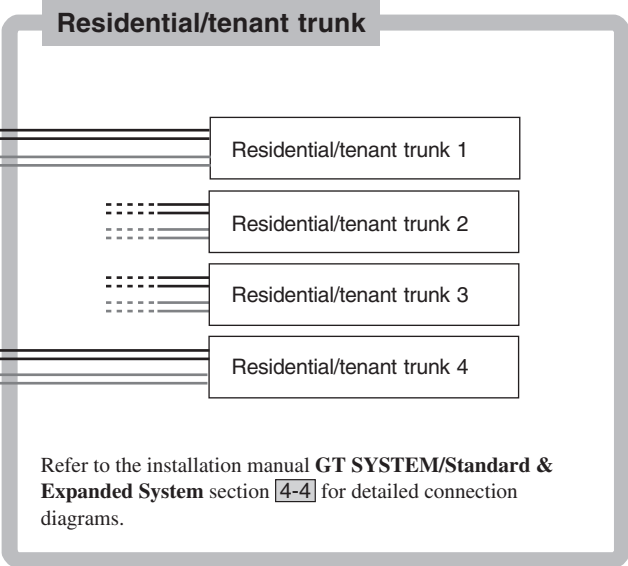
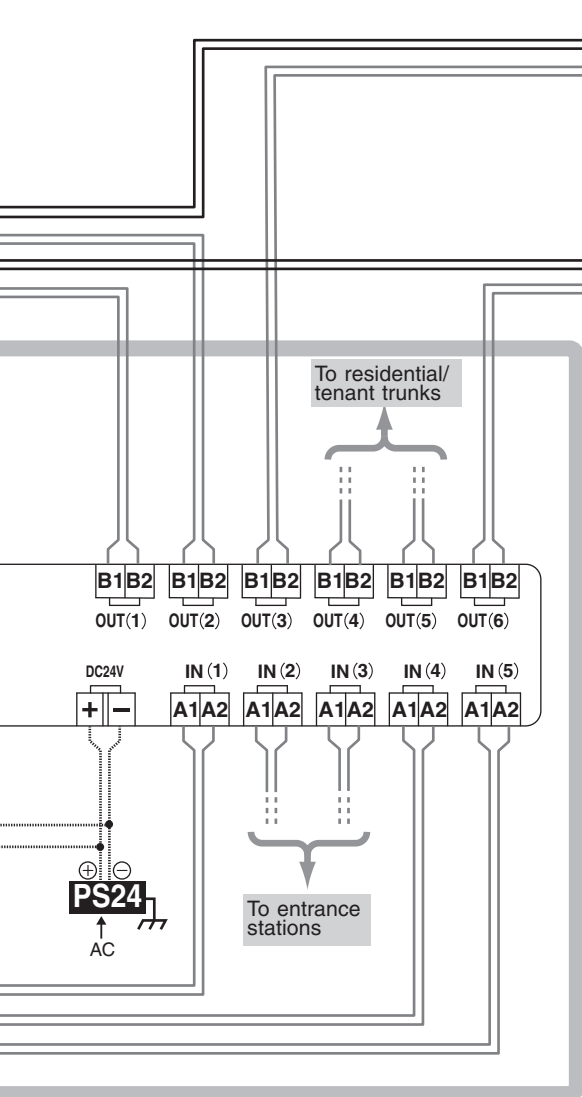

NP: Non-polarized

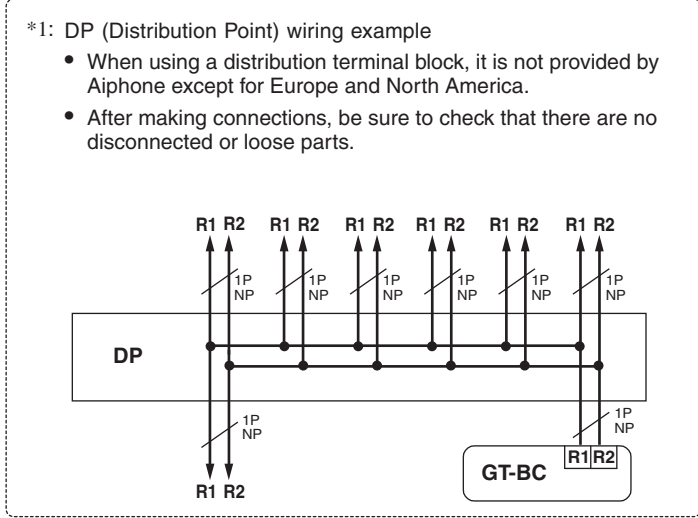

*1: DP (Distribution Point) wiring example

- When using a distribution terminal block, it is not provided by Aiphone except for Europe and North America.
- After making connections, be sure to check that there are no disconnected or loose parts.

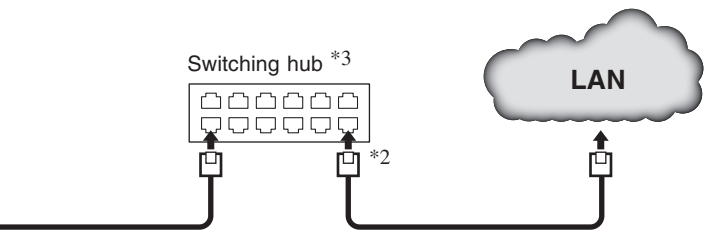

*3: Switching hub requirement (third party product)

- Packet delivery: Multicast
- Transmission rate: 100 Mbps or more

Main section (standard system)

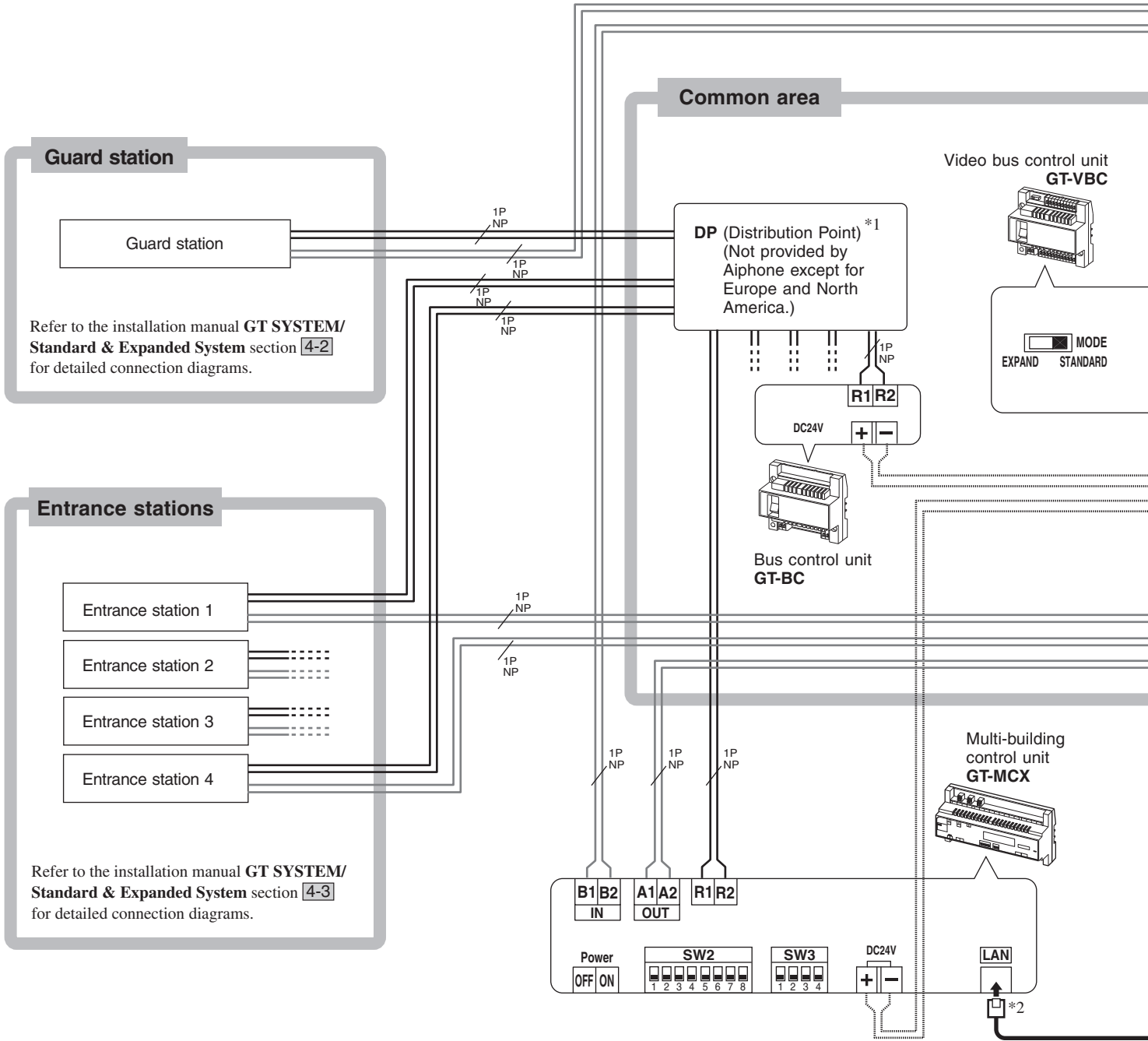

*2: NOTE: Do not route a CAT5e/6 cable outdoors from a multi-building control unit directly. When routing a CAT5e/6 cable outdoors from a switching hub, use a model that supports outdoor wiring.

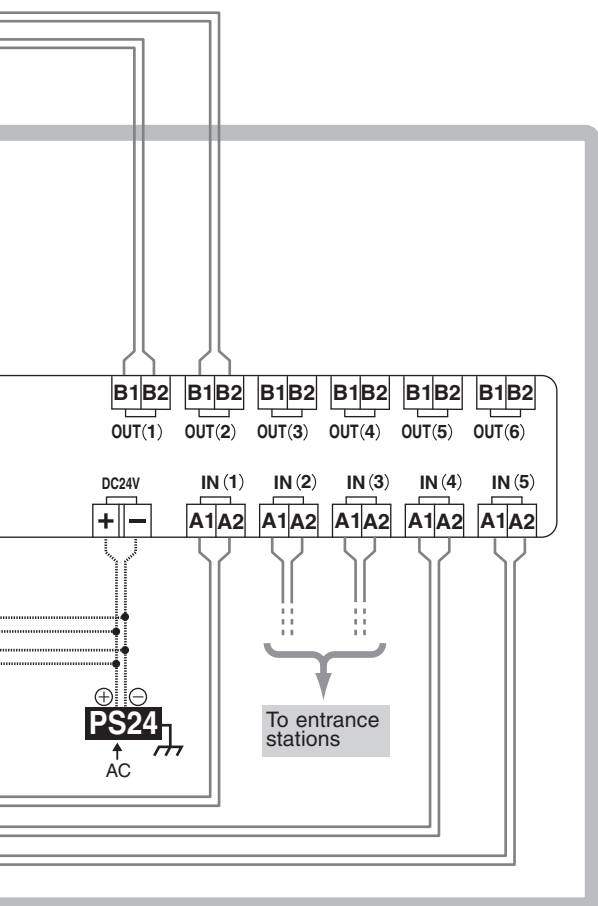

PS24

PS-2420DM

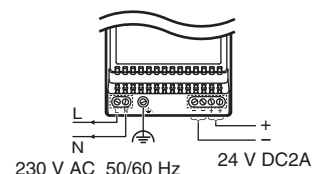

- PS-2420
- PS-2420S
- PS-2420UL
- PS-2420BF

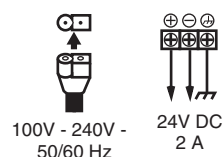

- : Audio signal line
- : Video signal line
- ⋯ : Power supply line
- : CAT5e/6 cable (100BASE-TX)

NP: Non-polarized

*1: DP (Distribution Point) wiring example

- When using a distribution terminal block, it is not provided by Aiphone except for Europe and North America.
- After making connections, be sure to check that there are no disconnected or loose parts.

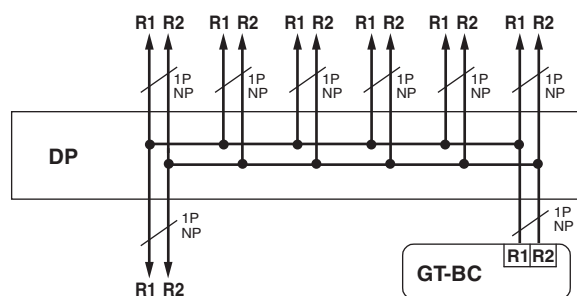

*3: Switching hub requirement (third party product)

- Packet delivery: Multicast
- Transmission rate: 100 Mbps or more

4-2 Multi building consisting of expanded systems

Tenant section (expanded system)

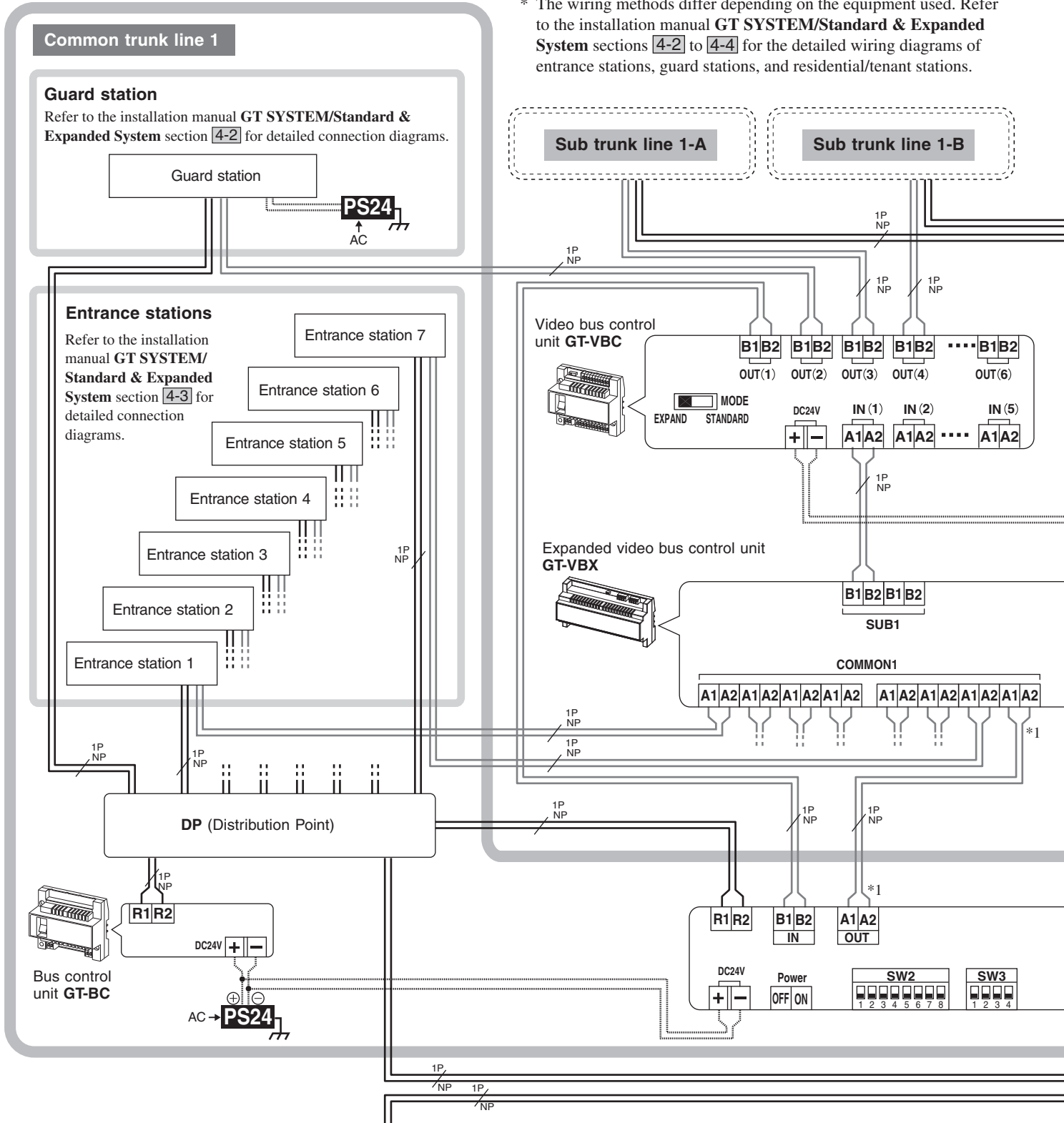

The following is a connection diagram example of a multi building system consisting of expanded systems as tenant and main sections.
 * The wiring methods differ depending on the equipment used. Refer to the installation manual **GT SYSTEM/Standard & Expanded System** sections 4-2 to 4-4 for the detailed wiring diagrams of entrance stations, guard stations, and residential/tenant stations.

Common trunk line 2

* Make connections in the same method as common trunk line 1. However, do not connect the GT-MCX to common trunk line 2.

To GT-VBX

To GT-VBC

*1: **NOTE**
 The GT-MCX must be connected to the common trunk line 1.

*3: Switching hub requirement (third party product)
 • Packet delivery: Multicast
 • Transmission rate: 100 Mbps or more

⚠ Each pair of wires should be in a separately jacketed cable (audio, video, and power wiring).

⚠ To prevent shorts, unused cables should be insulated.

NOTES:

- Do not use the unused terminals and ports for other purposes.
- In order to prevent miswiring, label both ends of each cable with the unit and terminal names to which they are to be connected.
- For connecting other manufacturers' products, refer to the instruction manuals for those products.

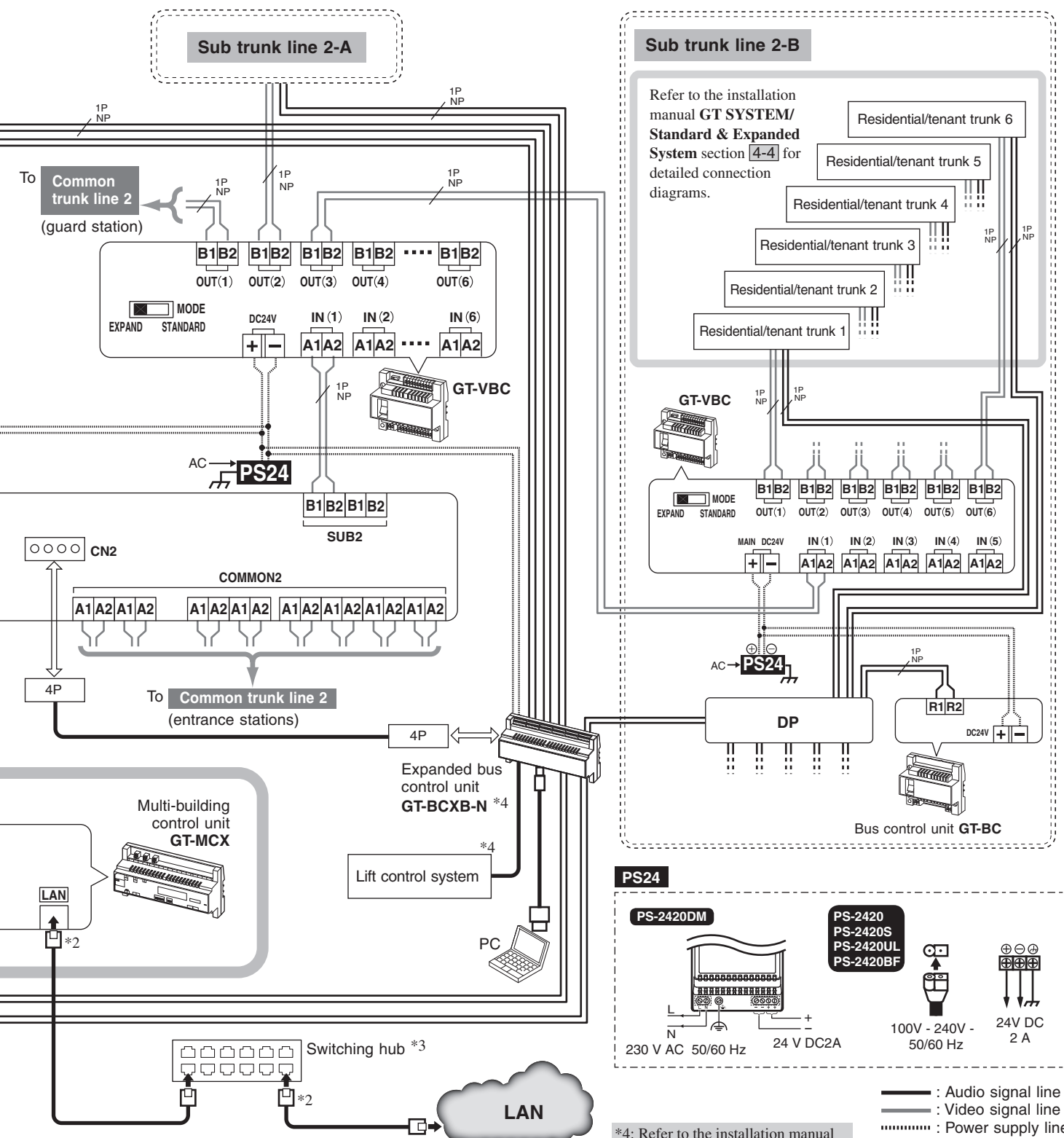

*2: NOTE: Do not route a CAT5e/6 cable outdoors from a multi-building control unit directly. When routing a CAT5e/6 cable outdoors from a switching hub, use a model that supports outdoor wiring.

*4: Refer to the installation manual GT SYSTEM/Standard & Expanded System sections [4-5] to [4-6] for details about the lift control system.

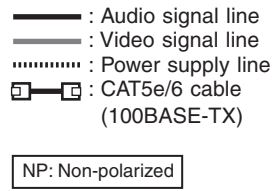

Main section (expanded system)

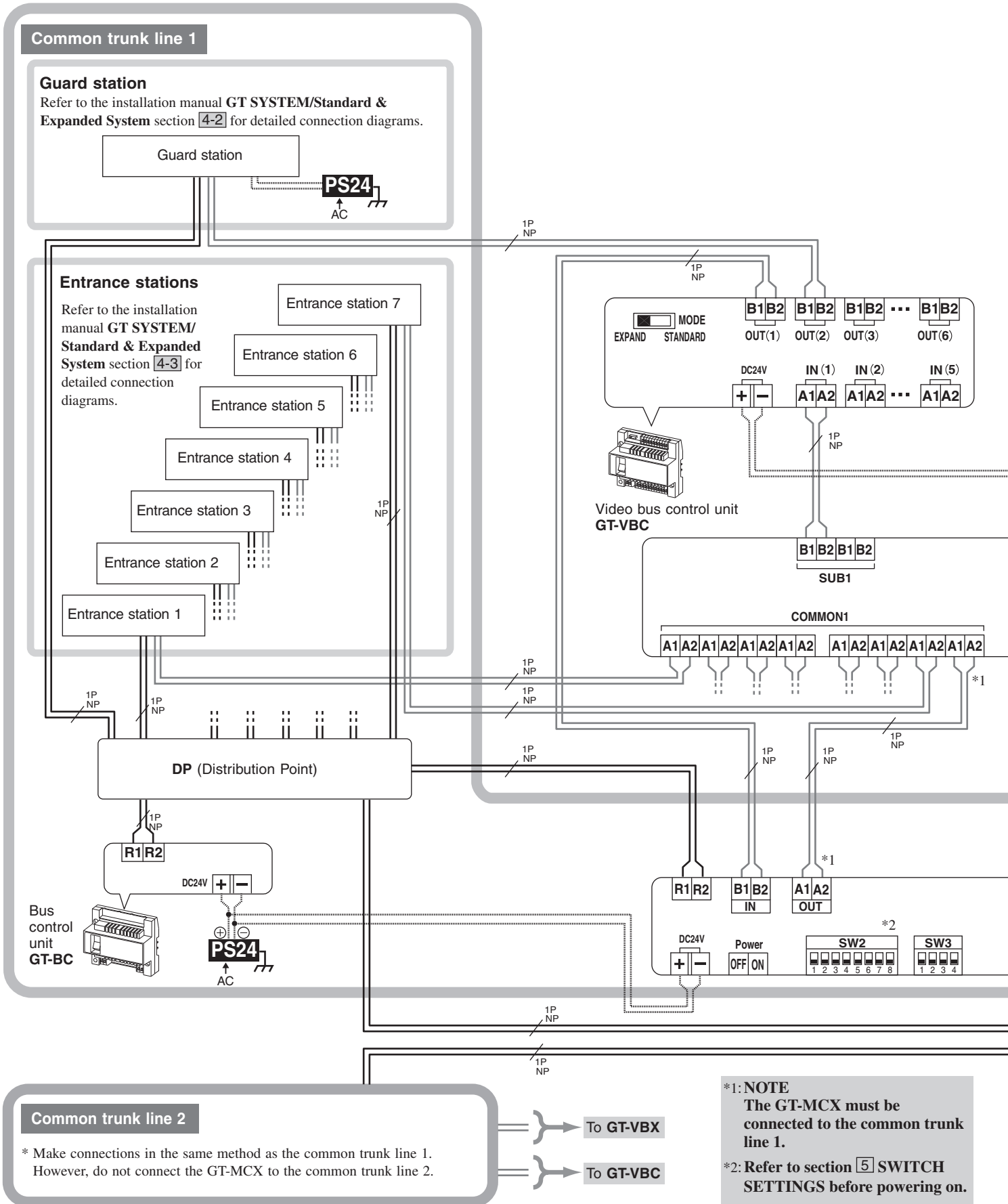

PS24

PS-2420DM

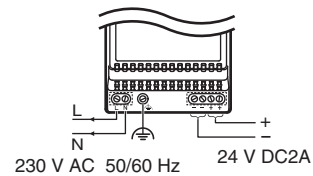

**PS-2420
PS-2420S
PS-2420UL
PS-2420BF**

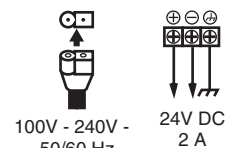

- : Audio signal line
- : Video signal line
- : Power supply line
- : CAT5e/6 cable (100BASE-TX)

NP: Non-polarized

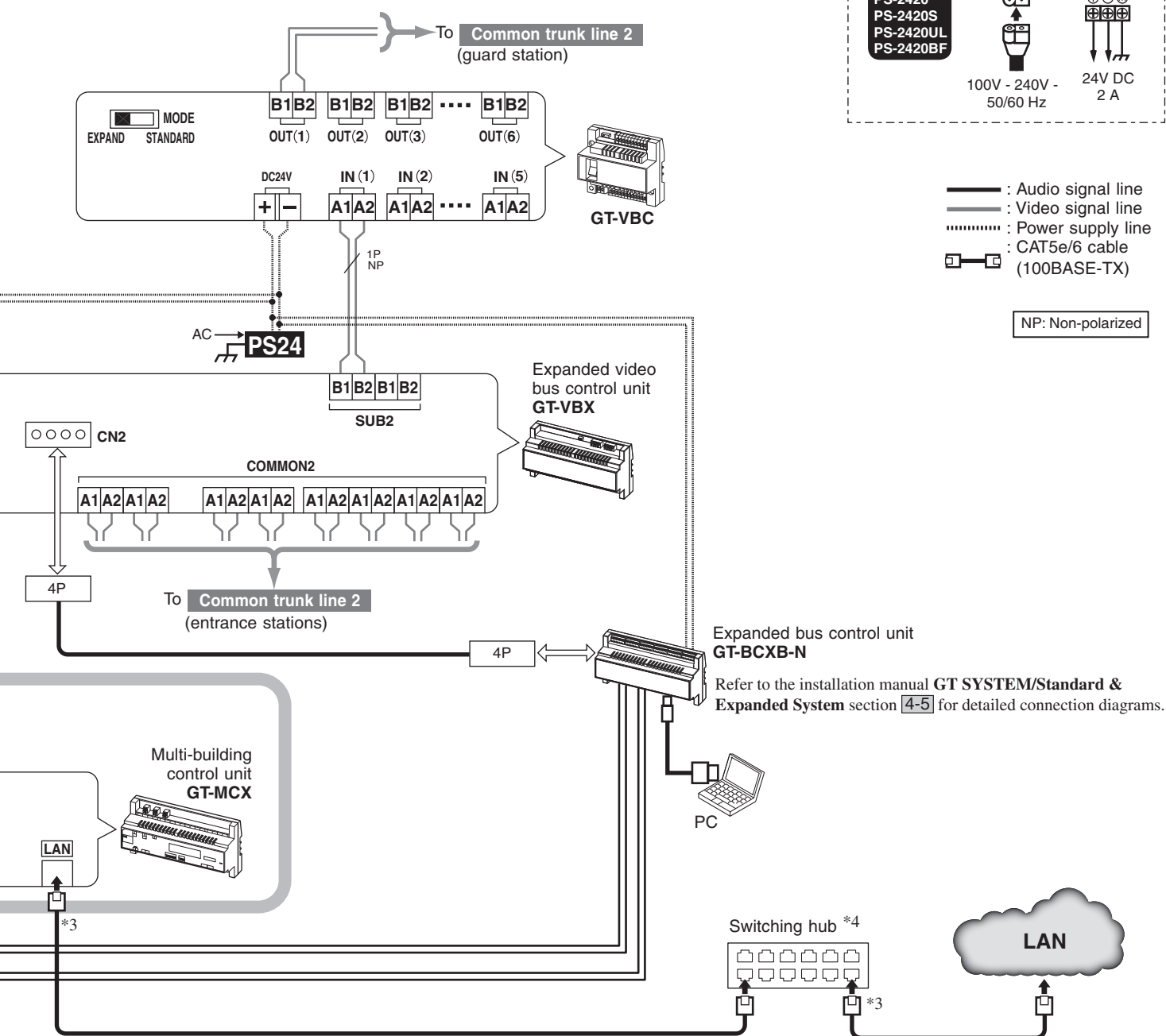

*3: Do not route a CAT5e/6 cable outdoors from a multi-building control unit directly. When routing a CAT5e/6 cable outdoors from a switching hub, use a model that supports outdoor wiring.

*4: Switching hub requirement (third party product)

- Packet delivery: Multicast
- Transmission rate: 100 Mbps or more

5 SWITCH SETTINGS

The multi building control unit, GT-MCX, needs to be initially set up via the DIP switches before powering on. The IP address will be assigned based on the section ID setting. (192.168.1.50 + Section ID)

Configuration will then need to be completed using the GT Setup Tool on a PC.

* Refer to the **GT SYSTEM Multi Building System** Setting manual for details about configuring the system settings.

* It is recommended to discuss the installation and setting method with the person responsible for installation in advance.

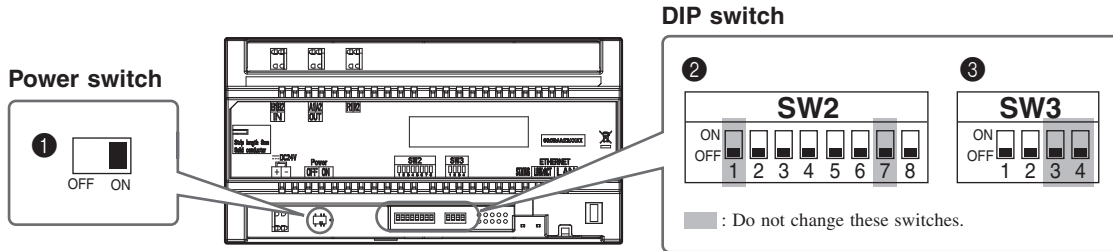

① Power switch

Set the switch to ON when using this unit.

② SW2

No.	Function	Default
2 to 6	Sets the local section ID. See "Section ID setting" below for details.	OFF/OFF/OFF OFF/OFF/OFF (ID 1)
8	Resets the passcode for the installer or administrator when this unit is initialized by setting this switch to ON.	OFF

③ SW3

No.	Function	Default
1	Sets whether DHCP is active or not. ON: DHCP is inactive. An IP address decided by the PC Link Setting method will be assigned to the unit. (Default IP address - 192.168.1.50) The IP address is set as follows. 192.168.1.α (α = 50 + Section ID) [Example] Section ID = 11 IP Address = 192.168.1.61 * For detailed explanation of IP setting, please refer to GT SYSTEM Multi building system Setting manual. OFF: DHCP is active. An IP address will be assigned automatically.	OFF
2	Initialization of the settings. * The set date is not initialized. Follow the procedure below.	OFF

How to initialize GT-MCX (③ SW3 - "2")

Procedure:

1 Turn the power switch OFF for the unit to be initialized.

2 Set the DIP switch "2" in SW3 to ON position.

3 Turn the power switch ON.

The status LED of the unit will flash for approximately 30 seconds; wait until the LED stops flashing.

* In the case date & time has not been set, the LED will continue to flash in approximately 6 second intervals after 30 seconds have passed.

4 The unit has now been initialized. Set the DIP switch "2" in SW3 to OFF position.

5 Turn the power switch ON.

This step completes the initialization procedure.

NOTE :

ID1 is unavailable for the entrance station and the guard station. (ID1 of each station is used for GT-MCX in a multi building system.)

Audio module (GT-DB, GT-DB-V, GT-DB-VN)

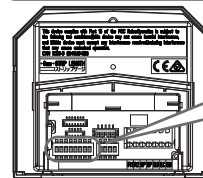

Entrance station (GT-DMB-LVN, GT-DMB-N)

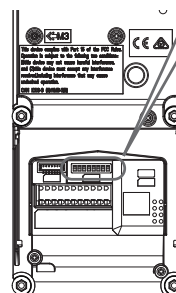

Guard station (GT-MKB-N)

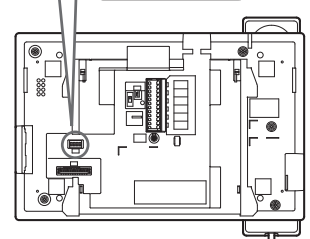

Section ID setting

Set the section ID (1 to 32) for this unit by the combination of the switch 2 to 6 settings, as shown below.

* Refer to **1 SYSTEM CONFIGURATIONS** for details about "section".

NOTE : Make sure not to repeat the same ID.

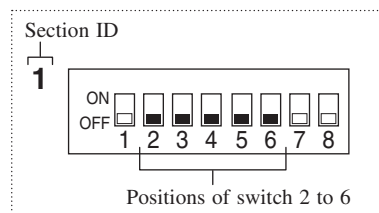

ID1 to ID24: Tenant sections

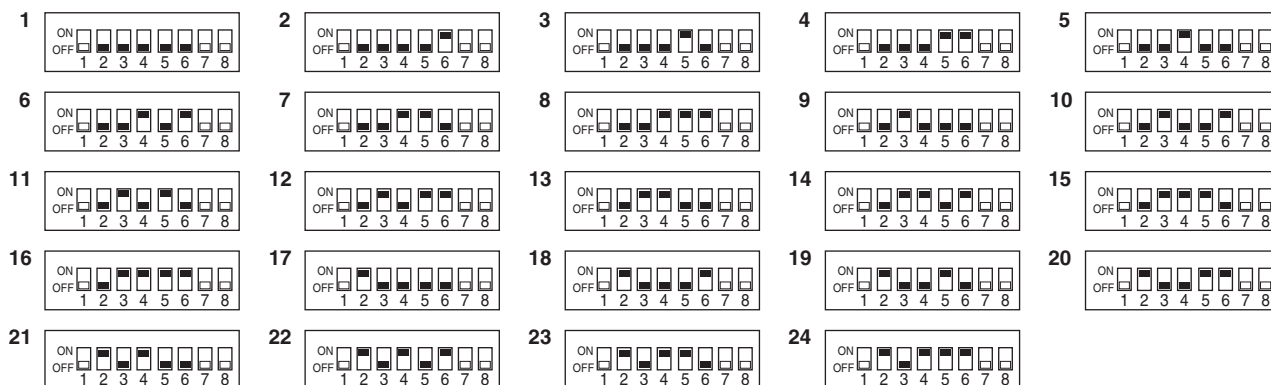

ID25 to ID32: Main sections

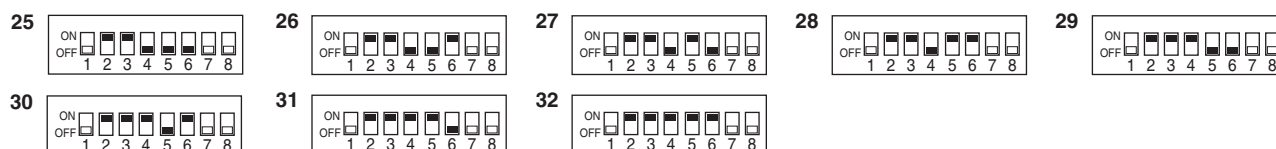

Please use the following table to note section information.

Tenant section

ID	Section information	ID	Section information
1		13	
2		14	
3		15	
4		16	
5		17	
6		18	
7		19	
8		20	
9		21	
10		22	
11		23	
12		24	

Main section

ID	Section information	ID	Section information
25		29	
26		30	
27		31	
28		32	

6 CHECK FOR INSTALLATION

When checking operation after system installation shows a malfunction in spite of no error in equipment terminal connections, check for the following "grounding point" and "ground fault" in wiring.

Tools required: Analog tester

NOTES:

- A digital tester cannot make a precise reading.
- A megohmmeter cannot be used.

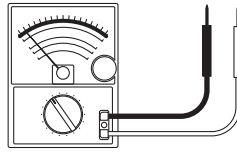

6-1 Finding a proper "grounding point" for power supply

- 1 Set the tester for 250V AC or more.
- 2 Find the "hot" side of the AC outlet to be connected with a power plug.
 - 2-1. Put one tester rod to the point that seems to be a grounding point.
 - 2-2. Touch the other tester rod contact to one of the AC outlet slots to find the side where the tester needle swings.

The side where the tester needle swings is the "hot" side.

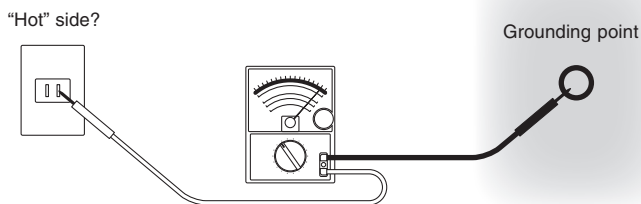

- 3 Find the proper grounding point.

- 3-1. With one tester rod put on the "hot" side, put the other to the point that seems to be a grounding point.
 - * If the needle swings to the power supply value for your country, it will be considered a proper grounding point.
 - If the needle does not reach the power supply value, it will not be considered a proper point.
- 3-2. Find the grounding point by repeating this step until the needle points to the proper value.

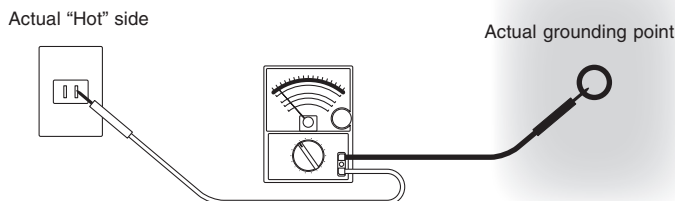

- 4 Connect the power supply ground terminal [⏏] with the grounding point found in step 3.

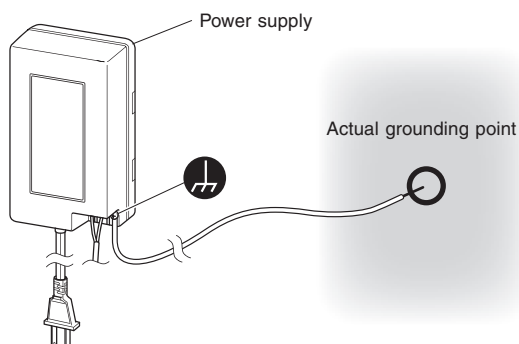

6-2 Checking "ground fault" with tester

What is "ground fault"?

"Ground fault" means the state where internal copper wire is touching a metal part (ground) in the building because the coating on the wiring of the intercom system is peeled off. This may cause the equipment to malfunction. Being in the ground fault state, the whole system will be damaged seriously by a "power surge."

Inspection conditions:

Important

- Check that the power supply is grounded properly as described in [6-1](#).
- Before starting inspection, make sure all control units (GT-BC, GT-VBC, GT-BCXB, GT-VBX, GT-MCX), entrance station, and guard station are turned on. (Only when the equipment is installed)

Inspection procedure:

- 1 Set the tester for around 50V DC.
- 2 Put one tester rod to the power supply ground terminal [17]. If the power supply is not nearby, find a grounding point referring to [6-1](#).
- 3 With one tester rod put on the power supply ground terminal, put the other to the following terminals to be inspected.

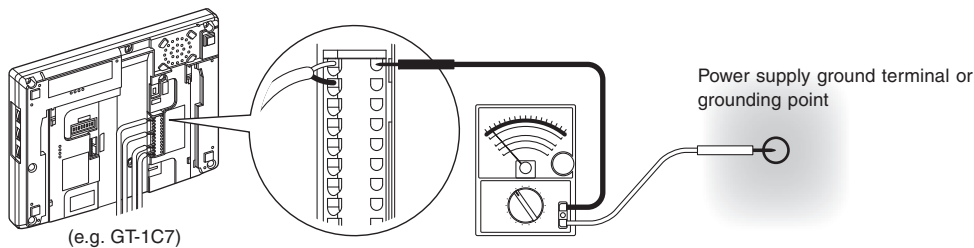

Product name	Terminal to be inspected
GT-BC	All [R1] and [R2]
GT-BCXB-N	All [R1] and [R2]
GT-VBC	All [A1], [A2], [B1] and [B2]
GT-VBX	All [A1], [A2], [B1] and [B2]
GT-MCX	[R1], [R2], [A1], [A2], [B1], [B2]
GT-VB	[A1], [A2]
GT-DB(-V, -VN)	[R1], [R2]
GT-DMB(-V, -LVN)	[R1], [R2], [A1], [A2]
GT-MKB-N	[R1], [R2], [A1], [A2], [B1], [B2]

Product name	Terminal to be inspected
GT-1C7W(-L) GT-2C(-L) GT-1C7(-L) GT-1M3(-L)	All [R1], [R2], [B1] and [B2]
GT-1A, GT-1D	All [R1] and [R2]
GT-4Z	All [R1], [R2], [B1] and [B2]
GT-1Z	All [B1] and [B2]
GTW-LC	[R1], [R2]
JO-DV	[A1], [A2]
DP (Distribution Point)	(Each line)

- 4 If the tester needle does not swing in step 3, it will be judged "no ground fault."

* If the tester needle swings, there is a ground fault in wiring between the power supply and the inspected point.
(The same is true in the case where the needle swings reversely.)

Solution:

Divide the wiring into sections or trunk lines, identify the ground fault point, and remove the cause.

REGULATIONS

FCC

This equipment has been tested and found to comply with the limits for a Class B digital device, pursuant to part 15 of the FCC Rules. These limits are designed to provide reasonable protection against harmful interference in a residential installation. This equipment generates, uses and can radiate radio frequency energy and, if not installed and used in accordance with the instructions, may cause harmful interference to radio communications. However, there is no guarantee that interference will not occur in a particular installation. If this equipment does cause harmful interference to radio or television reception, which can be determined by turning the equipment off and on, the user is encouraged to try to correct the interference by one or more of the following measures:

- Reorient or relocate the receiving antenna.
- Increase the separation between the equipment and receiver.
- Connect the equipment into an outlet on a circuit different from that to which the receiver is connected.
- Consult the dealer or an experienced radio/TV technician for help.

Changes or modifications to this equipment not expressly approved by the party responsible for compliance could void the user's authority to operate the equipment.

This device complies with Part 15 of the FCC rules. Operation is subject to the following two conditions: (1) this device may not cause harmful interference, and (2) this device must accept any interference received, including interference that may cause undesired operation. Privacy of communications may not be ensured when using this telephone.

To ensure safety of users, the FCC has established criteria for the amount of radio frequency energy that can be safely absorbed by a user or bystander according to the intended usage of the product. This product has been tested and found to comply with the FCC criteria. To comply with FCC RF exposure requirements, the device must be installed and operated 20 cm (8 inches) or more between the product and all person's body.

Keep a distance of more than 10 cm (3-15/16") from person's body while speaking. If you use the device within 10 cm (3-15/16"), please use within 1 minute.

INDUSTRY CANADA

CAN ICES-3 (B)/NMB-3(B)

WEEE

The object area of  is the EU.

WARRANTY

Aiphone warrants its products to be free from defects of material and workmanship under normal use and service for a period of 2 years after delivery to the ultimate user and will repair free of charge or replace at no charge, should it become defective upon which examination shall disclose to be defective and under warranty. Aiphone reserves unto itself the sole right to make the final decision whether there is a defect in materials and/or workmanship; and whether or not the product is within the warranty. This warranty shall not apply to any Aiphone product which has been subject to misuse, neglect, accident, power surge, or to use in violation of instructions furnished, nor extended to units which have been repaired or altered outside of the factory. This warranty does not cover batteries or damage caused by batteries used in connection with the unit. This warranty covers bench repairs only, and any repairs must be made at the shop or place designated in writing by Aiphone. This warranty is limited to the standard specifications listed in the operation manual. This warranty does not cover any supplementary function of a third party product that is added by users or suppliers. Please note that any damage or other issues caused by failure of function or interconnection with Aiphone products is also not covered by this warranty. Aiphone will not be responsible for any costs incurred involving on site service calls. Aiphone will not provide compensation for any loss or damage incurred by the breakdown or malfunction of its products during use, or for any consequent inconvenience or losses that may result.

 **AIPHONE**
Providing Peace of Mind
<https://www.aiphone.net/>

Issue Date: Dec. 2020

FK2351 (B) P1220 RZ 63189

AIPHONE CO., LTD., NAGOYA, JAPAN