

## Part names

### JO-1MDW

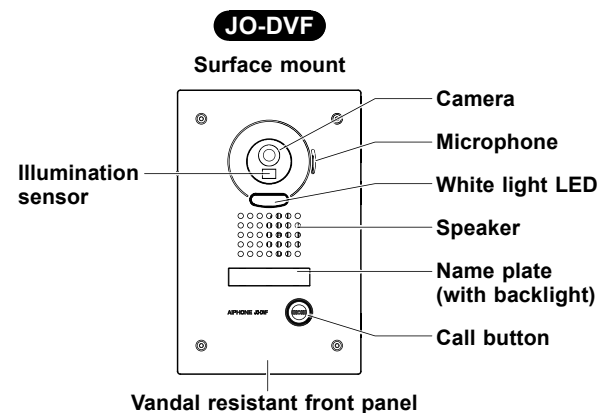
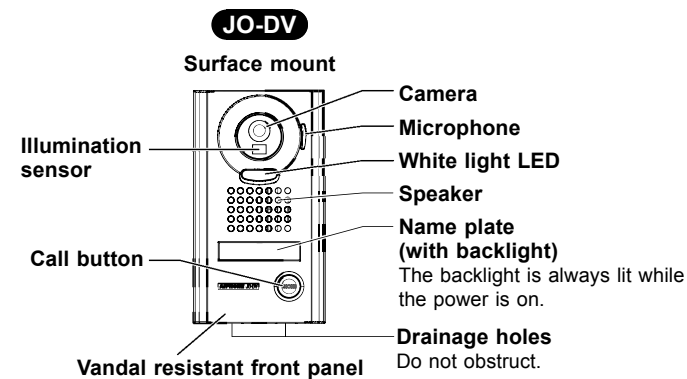
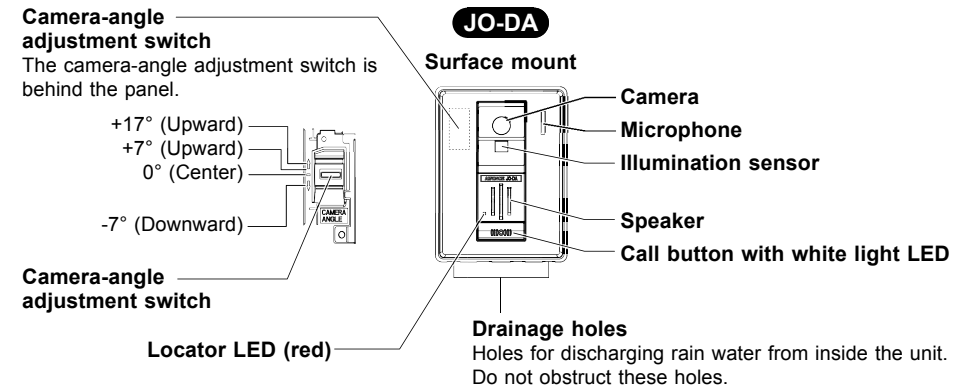
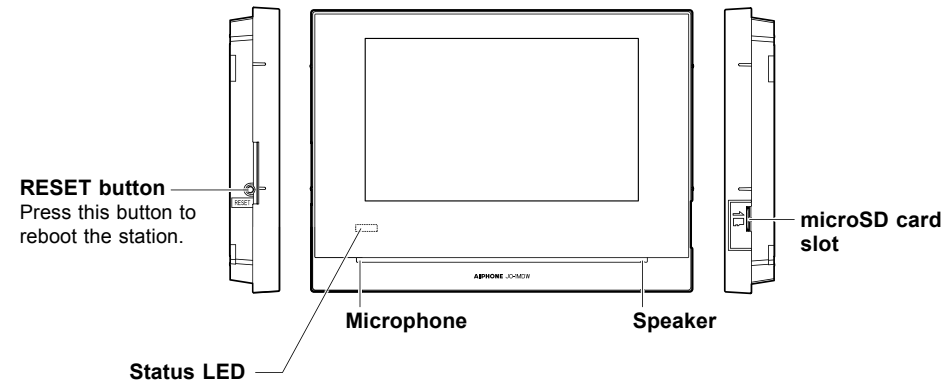

## Package contents

	JO-1MDW	JOS-1AW	JOS-1VW	JOS-1FW
<b>JO-1MDW</b>	✓	✓	✓	✓
<b>JO-DA</b>		✓		
<b>JO-DV</b>			✓	
<b>JO-DVF</b>				✓
 PS-1820, PS-1820S, PS-1820UL, PS-1820BF  PS-1820DM or Power supply		✓	✓	✓
 Installation manual	✓	✓	✓	✓
 Information sheet				
 Special screwdriver			✓	
 Special screwdriver (Hexagonal wrench)				✓
 Transparent name plate × 2			✓	✓

### NOTES:

- Mounting and wood mounting screws not included.
- microSDHC card is not included. Please purchase separately.
- For details on the power supply, see the installation manual of the power supply separately.

## Precautions

### ⚠ Warning Negligence could result in death or serious injury.

1. Do not dismantle or alter the unit. Fire or electric shock could result.
2. Do not use power supply with a voltage other than specified. Fire or electric shock could result.
3. Do not open the case. High voltage is present internally. Electric shock could result.
4. Do not install two power supplies in parallel to single input. Fire or damage to the unit could result.
5. Do not connect any terminal on the unit to AC power line. Fire or electric shock could result.
6. For power supply, use Aiphone power supply model specified for use with system. If non-specified product is used, fire or malfunction could result.

### ⚠ Caution Negligence could result in injury to people or damage to property.

1. Do not install or make any wire terminations while power supply is plugged in. It can cause electrical shock or damage to the unit.
2. Before turning on power, make sure wires are not crossed or shorted. Fire or electric shock could result.
3. Install the device in a position where it will not easily be brushed against by somebody's shoulder, etc. Failure to do so could result in injury.
4. Do not place your ear close to the speaker during use. It could cause hearing damage.

## Precautions for mounting

1. Installing the device in the following locations could cause malfunction:
  - \* Locations exposed to direct sunlight
  - \* Locations that get hot  
Close to a heater, boiler, etc.
  - \* Locations where there is risk of exposure to liquid, dust, oil, or chemicals
  - \* Locations with high humidity  
Bathroom, basement, greenhouse, etc.
  - \* Locations with low temperature  
Inside a cold storage warehouse, the front of a cooler, etc.
  - \* Locations directly exposed to steam or oil smoke  
Next to heating devices or a cooking space, etc.
  - \* Sulphurous environments such as a hot spring area
  - \* Locations close to the sea or directly exposed to sea breeze
2. In 50Hz regions, if a strong fluorescent light shines directly into the camera, it may cause the image to flicker. Either shield the camera from the light or use an inverter fluorescent light.
3. For running cables, separate them for audio/video and door release and keep them more than 10cm (3-15/16") away from each other.
4. When using an existing wiring, depending on the type of wiring, it may not operate the system. In case of that, change wiring is required.
5. Do not use the impact driver for mounting. Damage to the unit could result.
6. Avoid installing the master monitor station in concave space of a wall to prevent disconnection of communication.

## General Precautions

1. Install low-voltage lines at least 30cm (11") away from high-voltage lines (AC100V-240V), especially inverter air conditioner wiring. Failure to do so may result in interference or malfunction.
2. When installing or using the device, give consideration to the privacy rights of subjects, as it is the responsibility of the system owner to post signs or warnings in accordance with local ordinances.

## Notices

1. Please note that images and illustrations depicted in this manual may differ from the actual ones.
2. Using a mobile phone or professional-use radio equipment such as walkie-talkie close to the system may cause a malfunction.
3. In areas where broadcasting station antennas are close by, the intercom system may be affected by radio frequency interference.
4. Do not install the unit close to an electrical appliance or water heater using a dimmer or inverter, a remote controller of floor heating, etc. Failure to do so may generate a noise causing a malfunction of the unit.
5. When warm indoor air flows into the unit, dew condensation may be caused by a temperature difference between indoors and outdoors. It is recommended to cover openings on the unit such as cable incoming holes to avoid condensation.
6. In areas where microwave is close by, the intercom system may be affected by radio frequency interference.

# Installation

## Cable

- Use PE (polyethylene)-insulated PVC jacket cable. Parallel or jacketed 2-conductor, mid-capacitance non-shielded cable is recommended.
- Never use individual conductors, twisted pair cable or coaxial cable.



To connect low voltage wires, either crimp them with a crimp sleeve or solder them, and then insulate by covering with insulating tape.

### [Crimping with a crimp sleeve]

- Line up solid and stranded conductors, and crimp them.
- Overlap more than half of the width and twist them at least twice.

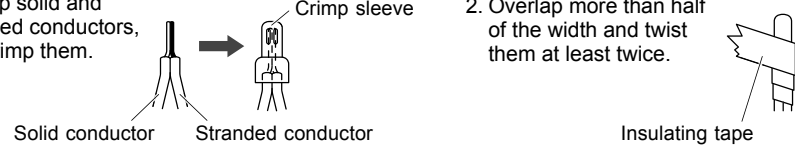

### [Soldering]

- Twist the stranded conductor around the solid conductor at least three times.
- Bend the tip and solder it. Make sure no lead wire sticks out.
- Overlap more than half of the width and twist them at least twice.

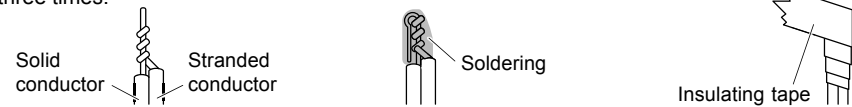

**Keep the number of connections as low as possible when wiring.**

After connecting wires, always check for breaking or insufficient connection. Especially when connecting a wire in the middle of wiring, either crimp it with a crimp sleeve or solder it, and then insulate it by covering with insulating tape.

Just twisting wires may cause poor connection, or the surface of the wires may get oxidized and cause a loose connection, leading to malfunctioning or failure.



### NOTES:

- If the lead wire with a connector is short, extend it by using an interconnecting cable.
- Connectors have polarity, so pay attention and connect properly. If connected incorrectly, the device won't work.

## When using existing cables

Check for short circuit and disconnection before installation.

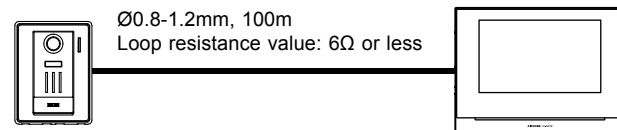

### Disconnection check (6Ω or less)

Connect the ends of one side and make a measure at the other side with a tester.

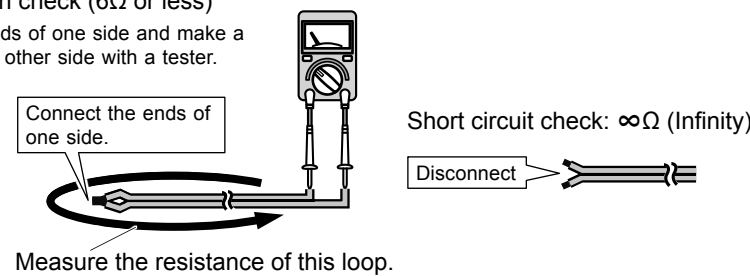

## Wiring method, wiring distance

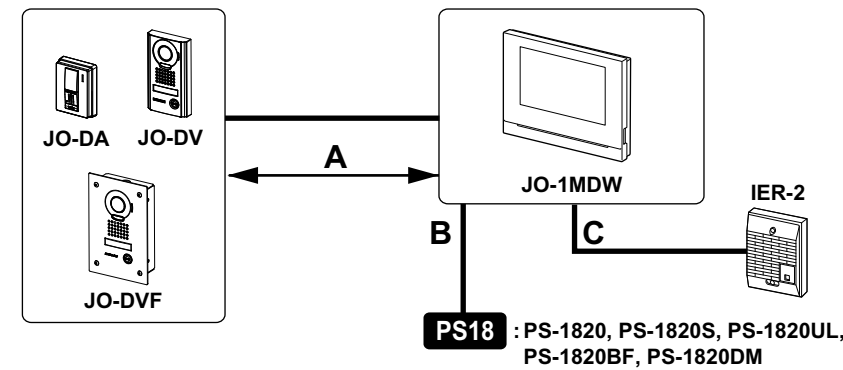

	∅ 0.65 mm	22 AWG	∅ 0.8-1.2 mm	20-16 AWG
A	50 m	165'	100 m	330'
B	5 m	16'	10 m	33'
C	50 m	165'	150 m	490'

## Mounting locations

### JO-DA, JO-DV, JO-DVF

Do not install the door station in any of the following locations where lighting or the ambient environment could impact the camera of the unit.

- Where lights will be shining directly into the camera at night time.
- Where the sky fills much of the background.
- Where the background of the subject is white.
- Where sunlight or other strong light sources will shine directly into the camera.

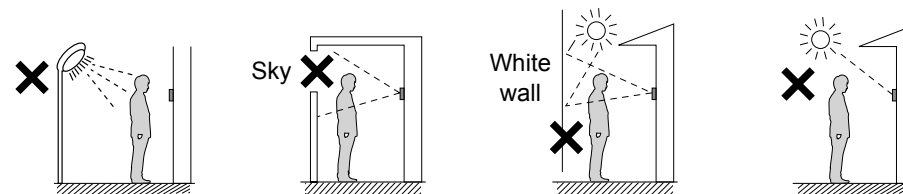

### JO-1MDW

- Do not install the master monitor station at a location exposed to direct sunlight.
- Avoid installing the master monitor station in a concave space of a wall to prevent audio distortion.
- Make sure to leave at least the specified spaces on all sides to prevent malfunction and audio distortion.

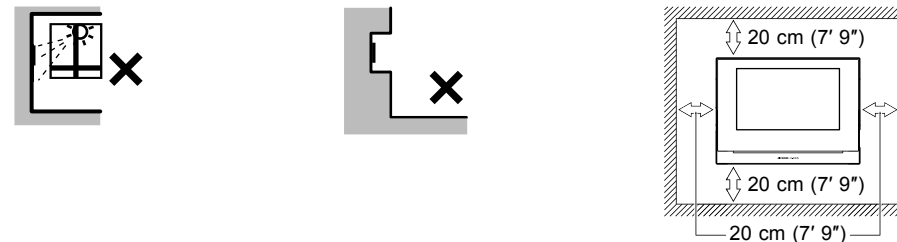

- Do not embed the master monitor station inside a wall.
- The reset button is on the left side and the microSDHC card slot is on the right side of the master monitor station. Be sure to install the station at a location where all buttons can be reached by hand.
- Install the master monitor station more than 3 meters apart from all wireless equipment.

## Mounting positions and image view area

### JO-DA, JO-DV, JO-DVF

#### Horizontal

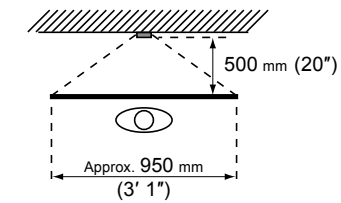

#### Vertical

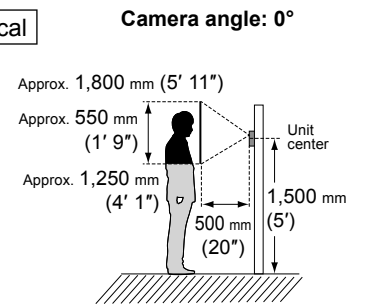

### JO-DA only

Refer to the diagrams below when the camera angle is changed with the adjustment switch.

#### Camera angle: 7°

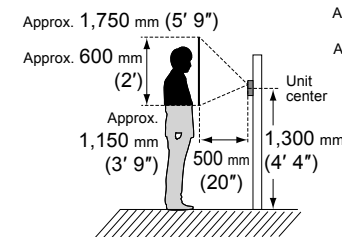

#### Camera angle: 17°

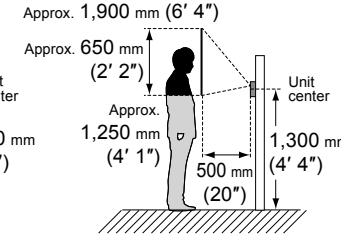

#### Camera angle: -7°

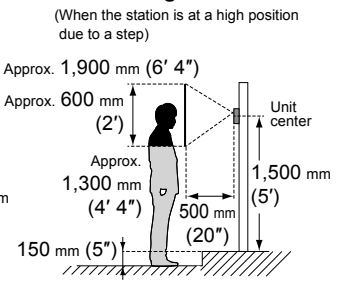

## Wi-Fi installation requirements

The master monitor station incorporates wireless LAN antennas. The Wi-Fi signal may not reach the master monitor station depending on the installation environment such as wall materials or the number of walls. Make sure the master monitor station receives a Wi-Fi signal successfully before installing the master monitor station. If the Wi-Fi signal does not reach the master station, change the installation location of the router or the master station.

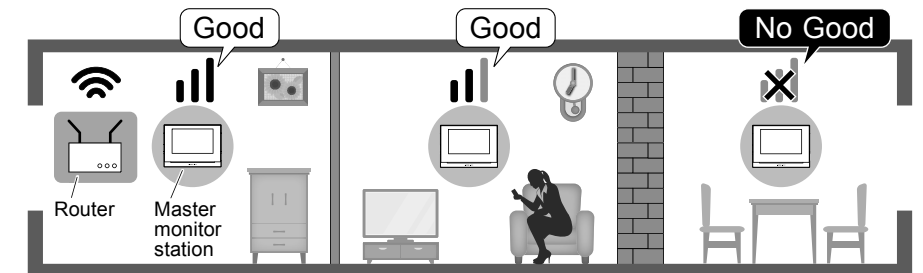

- Partition masonry walls
- Wood walls
- Plasterboard walls

- Reinforced concrete walls
- Load-bearing walls
- Stone walls
- Metal walls

## Mounting

### JO-1MDW

#### <Back wiring>

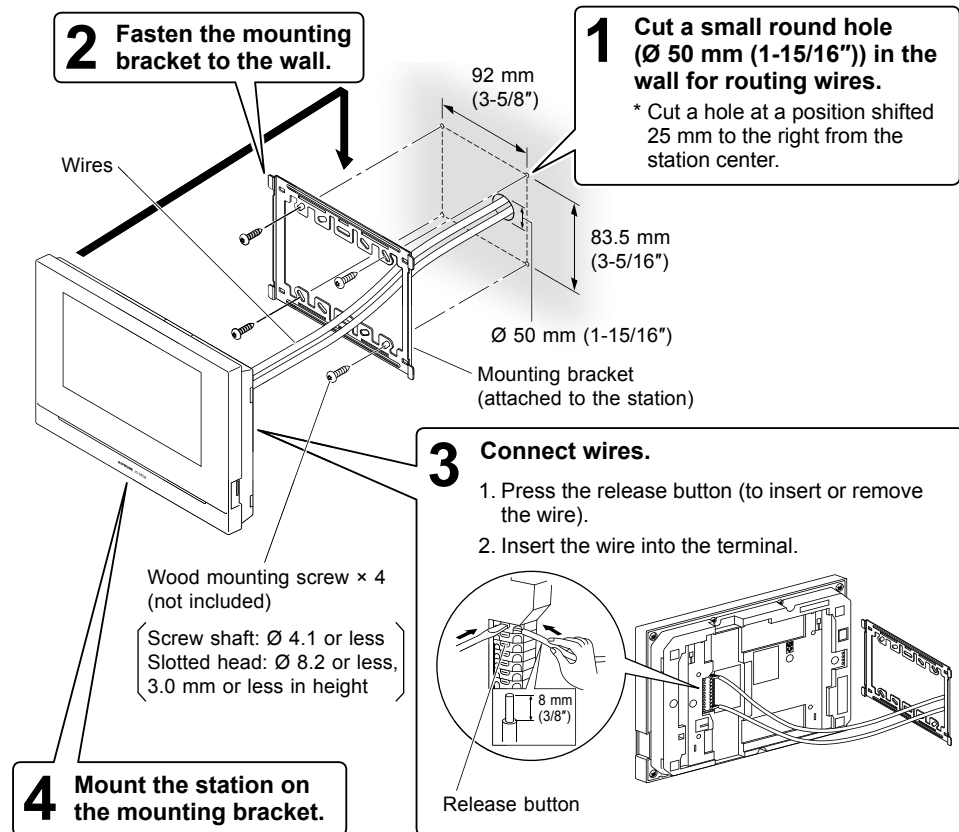

**NOTE:**  
 When using a gang box, select a 3-gang box.

#### <Surface wiring>

The wires can be routed to the top or bottom of the station.  
 Cut the cable inlet to allow passage of the wiring into the station from the top or bottom of the station.  
 If there is a large amount of wiring, strip away the jacket of the wire up to the cable inlet.

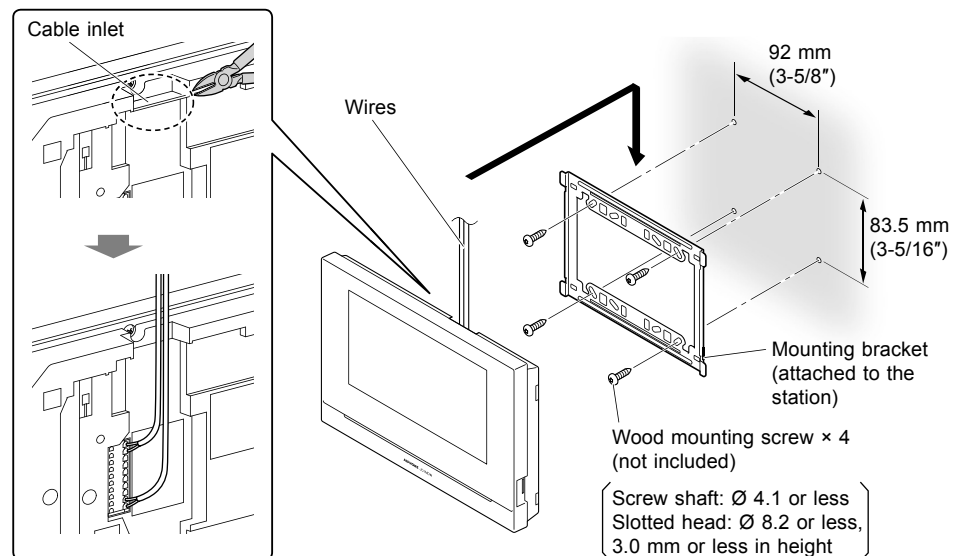

When wood mounting screws cannot be used for plasterboard walls, concrete walls and so on, use commercially-available board anchors or concrete plugs.

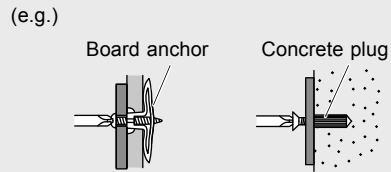

Use cable molding for the power wire and weak electric wires. A bare wire part between the station and cable molding should be 80 mm or less.

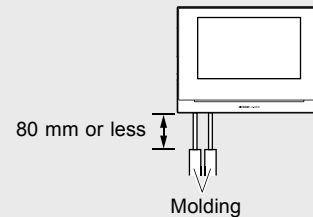

### JO-DA

#### <Back wiring>

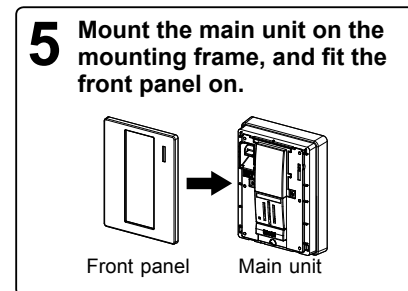
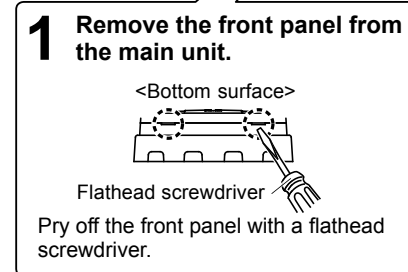
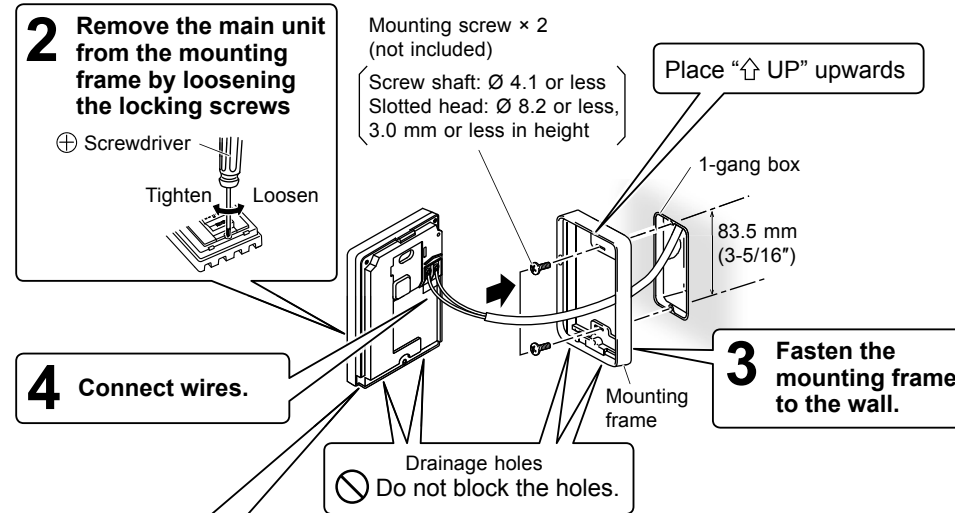

#### <Surface wiring>

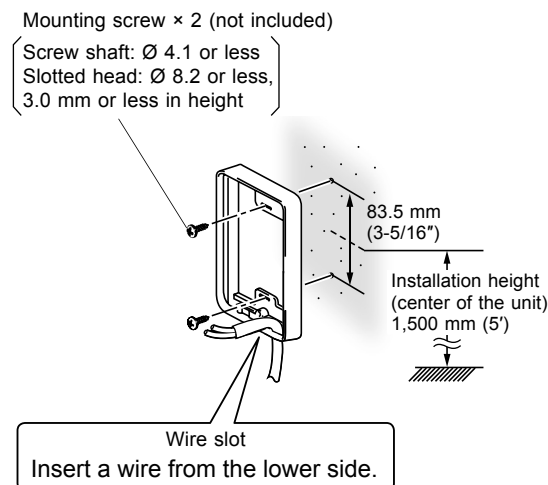

### JO-DV

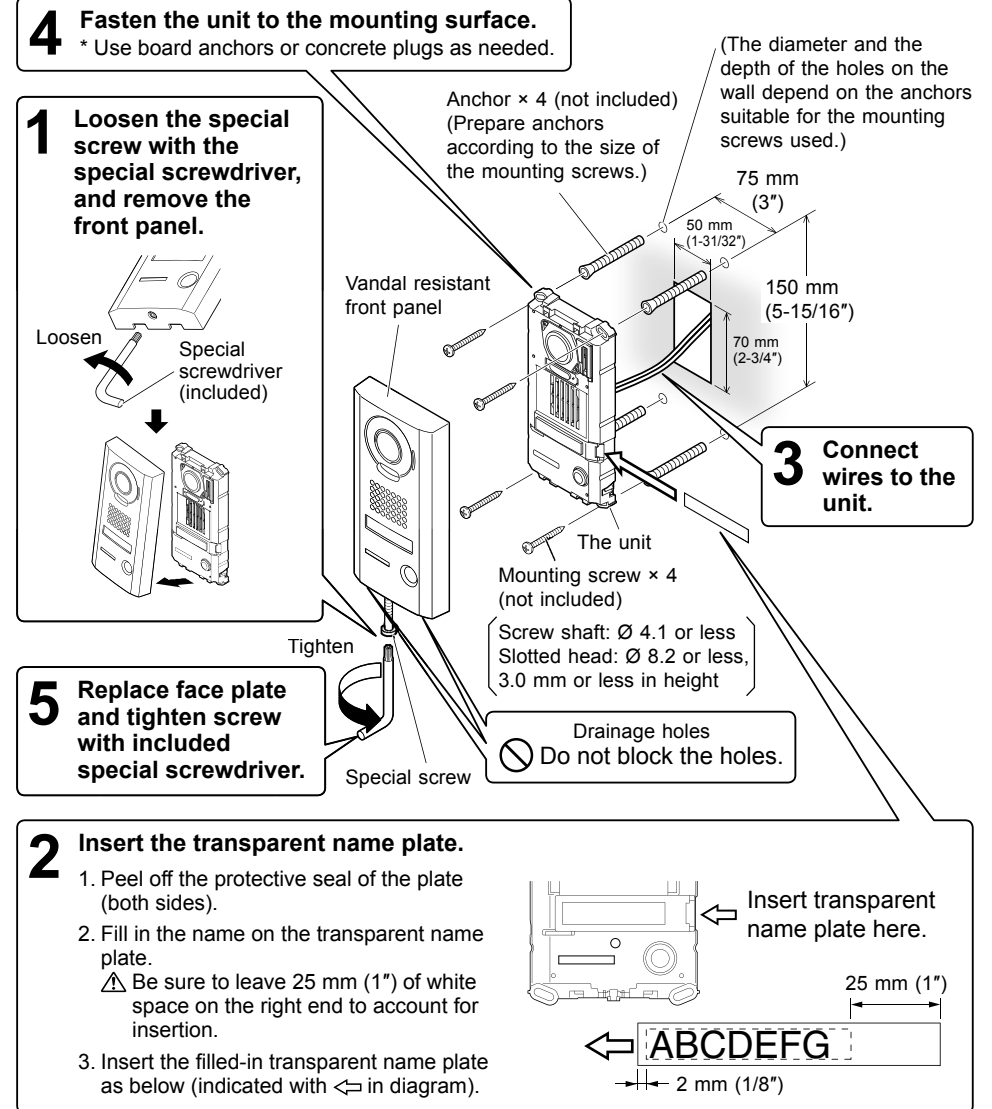

### JO-DVF

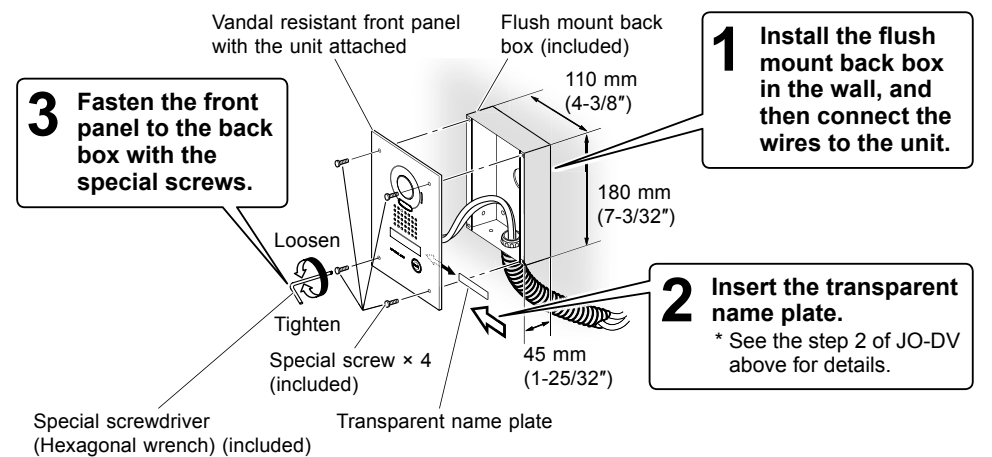

## Wiring

Insert wires securely into each terminal as shown below.

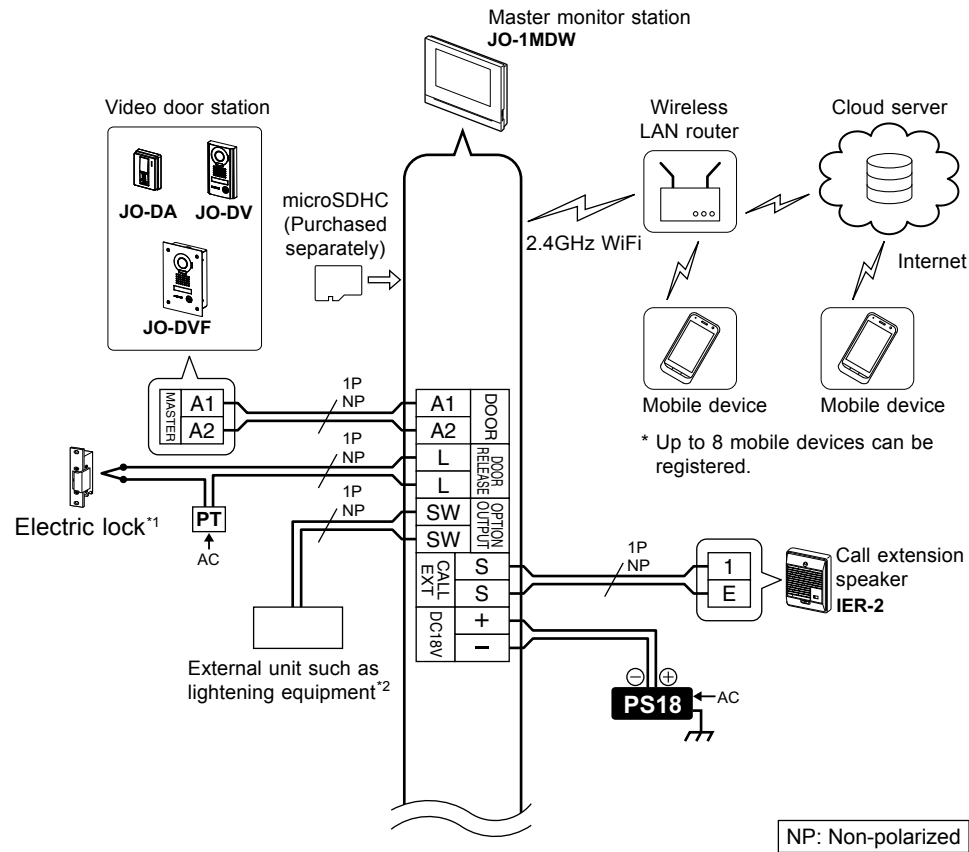

NP: Non-polarized

**PS18** : Power supply

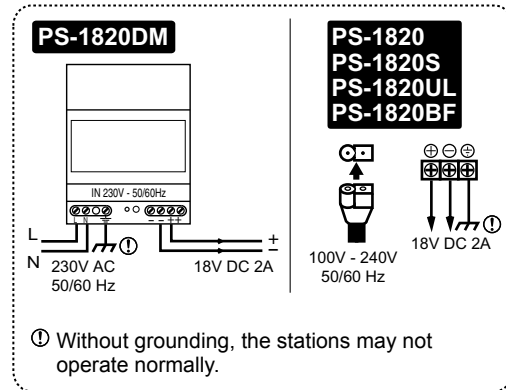

\*1: An EL-12S (AC 12 V, 0.125 A, DC 12 V, 0.2 A) or equivalent part and a separate AC transformer (or power supply) are required. Door release contact: AC/DC 24 V, 1 A (Minimum contact: 100 mV DC, 0.1 mA) (N/O dry closure contact L, L).  
\* Run separate cables for audio/video and door release.

\*2: AC/DC 24V, 1A N/O dry closure contact (Minimum contact: 100mV DC, 0.1mA)

## Technical precautions

### Cleaning:

- Clean all units with a soft cloth and gentle cleaner. Do not spray cleaner directly on unit. Do not use an abrasive cleaner or cloth.
- Video door stations are weather resistant.

### Wiring:

- If a short is detected between A1 and A2 of the door station, the unit stops functioning and the Status LED flashes rapidly until the short is removed. Check the wires.
- If noise is heard from the master monitor station, the wiring is disconnected between the video door station and the master monitor station.

### Trouble:

- If the station does not respond, reboot the station by pressing the RESET button.

## Regulations

### FCC

This device complies with part 15 of the FCC Rules. Operation is subject to the following two conditions: (1) This device may not cause harmful interference, and (2) this device must accept any interference received, including interference that may cause undesired operation.

**NOTE:** This equipment has been tested and found to comply with the limits for a Class B digital device, pursuant to part 15 of the FCC Rules. These limits are designed to provide reasonable protection against harmful interference in a residential installation. This equipment generates, uses and can radiate radio frequency energy and, if not installed and used in accordance with the instructions, may cause harmful interference to radio communications. However, there is no guarantee that interference will not occur in a particular installation. If this equipment does cause harmful interference to radio or television reception, which can be determined by turning the equipment off and on, the user is encouraged to try to correct the interference by one or more of the following measures:

- Reorient or relocate the receiving antenna.
- Increase the separation between the equipment and receiver.
- Connect the equipment into an outlet on a circuit different from that to which the receiver is connected.
- Consult the dealer or an experienced radio/TV technician for help.

### INDUSTRY CANADA

CAN ICES-3 (B)/NMB-3(B)

### WEEE

The object area of  is the EU.

## Warranty

Aiphone warrants its products to be free from defects of material and workmanship under normal use and service for a period of 2 years after delivery to the ultimate user and will repair free of charge or replace at no charge, should it become defective upon which examination shall disclose to be defective and under warranty. Aiphone reserves unto itself the sole right to make the final decision whether there is a defect in materials and/or workmanship; and whether or not the product is within the warranty. This warranty shall not apply to any Aiphone product which has been subject to misuse, neglect, accident, power surge, or to use in violation of instructions furnished, nor extended to units which have been repaired or altered outside of the factory. This warranty does not cover batteries or damage caused by batteries used in connection with the unit. This warranty covers bench repairs only, and any repairs must be made at the shop or place designated in writing by Aiphone. This warranty is limited to the standard specifications listed in the operation manual. This warranty does not cover any supplementary function of a third party product that is added by users or suppliers. Please note that any damage or other issues caused by failure of function or interconnection with Aiphone products is also not covered by this warranty. Aiphone will not be responsible for any costs incurred involving on site service calls. Aiphone will not provide compensation for any loss or damage incurred by the breakdown or malfunction of its products during use, or for any consequent inconvenience or losses that may result.

 **AIPHONE**®  
Providing Peace of Mind  
<https://www.aiphone.net/>