

BOSCH

Invented for life

LTC 9210/01, LTC 9215/00 (S), LTC 9219/01, and LTC 9223/01 Indoor/ Outdoor Mounts



- ▶ **Feed-through Design for Cable Management**
- ▶ **Maximum Load: 9 kg (20 lb)**
- ▶ **360° Rotation, 180° Tilt**
- ▶ **Versatile Design**
- ▶ **Adjustable Mount Heads**
- ▶ **Lightweight**
- ▶ **Corrosion-resistant Finish**

The LTC 9210/01, LTC 9215/00, LTC 9215/00S, LTC 9219/01 and the LTC 9223/01 feed-through mounts are indoor/outdoor mounting units designed for fixed camera, or camera housing installations with up to a 9 kg (20 lb) rated load. These models are made of lightweight aluminum and feature welded construction, providing an extremely rigid camera mount. In addition, the versatile swivel head rotates 360° and tilts 180° for maximum flexibility. The tubular feed-through design provides cable management from mounting head to mounting surface.

These mounts are compatible with the UHI Indoor Housing series and the UHO Outdoor Housing series. The LTC 9215/00S, has been designed specifically for the LTC 9480 Series housings, while the larger LTC 9215/00 and LTC 9219/01 can be used with the LTC 9480, HSG 9483, and the LTC 9488 Series camera housings. All mounts come fully assembled.

Installation/Configuration Notes

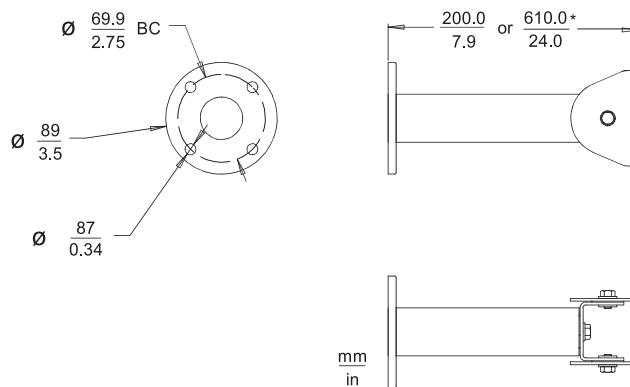

LTC 9210/01 and LTC 9223/01 Column Mount

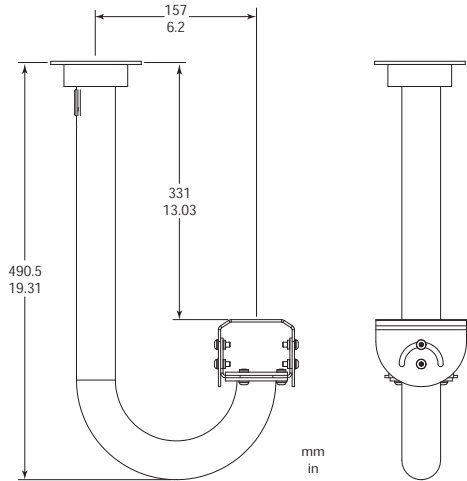

LTC 9219/01 Feed-through J-Mount

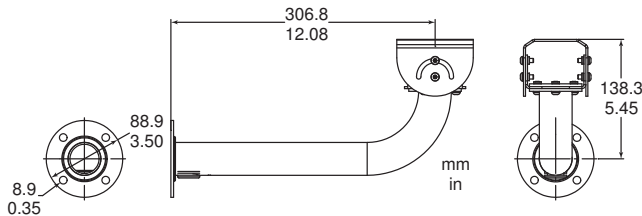
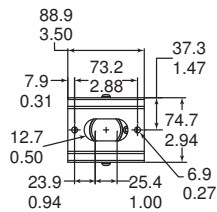

LTC 9215/00 Wall Bracket

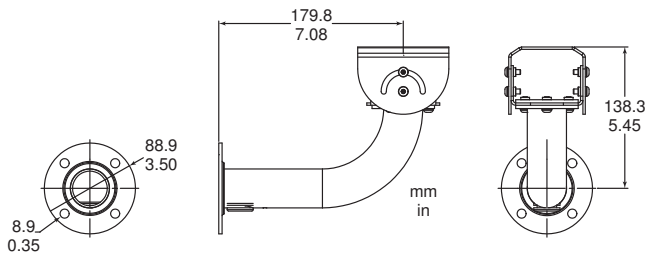
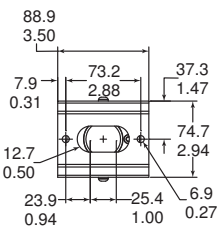

LTC 9215/00S Short Wall Bracket

Technical Specifications

LTC 9210/01 20 mm (8 in) Indoor/Outdoor

Column Mount	
Maximum Load	9 kg (20 lb)
Mounting Head	Adjustable 360° pan, 180° tilt
Finish	Light gray
Approx. Weight	0.3 kg (0.6 lb)

LTC 9215/00 30 mm (12 in) Indoor/Outdoor

Feed-through Wall Mount	
Maximum Load	9 kg (20 lb)
Mounting Head	Adjustable 360° pan, 180° tilt
Finish	Light gray
Approx. Weight	0.4 kg (0.9 lb)
Accessory for LTC 9215/00	LTC 9213/01 Pole Mount Adapter

LTC 9215/00S 18 cm (7 in) Indoor/Outdoor

Feed-through Wall Mount	
For use with LTC 9480 Series housings.	
Maximum Load	9 kg (20 lb)
Mounting Head	Adjustable 360° pan, 180° tilt
Finish	Light gray
Approx. Weight	0.3 kg (0.7 lb)
Accessory for LTC 9215/00S	LTC 9213/01 Pole Mount Adapter

LTC 9219/01 40 cm (15 in) Indoor/Outdoor

Feed-through Ceiling J-Mount	
Maximum Load	9 kg (20 lb)
Mounting Head	Adjustable 360° pan, 180° tilt
Finish	Light gray
Approx. Weight	0.55 kg (1.2 lb)

LTC 9223/01 610 mm (24 in) Indoor/Outdoor

Column Mount	
Maximum Load	9 kg (20 lb)
Mounting Head	Adjustable 360° pan, 180° tilt
Finish	Light gray
Approx. Weight	0.544 kg (1.2 lb)

Warning Mounts must be mounted as shown.

Ordering Information

LTC 9210/01 Column Mount for 8-inch, 9 kg (20 lb) max load, light gray finish	LTC 9210/01
LTC 9215/00 Wall Bracket for 12-inch, 9 kg (20 lb) max load, for LTC 9380 and LTC 948x series housings, feed-through version, light gray finish	LTC 9215/00
LTC 9215/00S Short Wall Bracket for 7-inch, 9 kg (20 lb) max load, for LTC 938x and LTC 948x series housings, feed-through version, light gray finish	LTC 9215/00S
LTC 9219/01 Feed-through J-Mount for 15-inch, 9 kg (20 lb) max load, for LTC 938x and LTC 948x series housings, light gray finish	LTC 9219/01
LTC 9223/01 Column Mount for 24-inch, 9 kg (20 lb) max load, light gray finish	LTC 9223/01

Americas:

Bosch Security Systems, Inc.
130 Perinton Parkway
Fairport, New York, 14450, USA
Phone: +1 800 289 0096
Fax: +1 585 223 9180
security.sales@us.bosch.com
www.boschsecurity.us

Europe, Middle East, Africa:

Bosch Security Systems B.V.
P.O. Box 80002
5600 JB Eindhoven, The Netherlands
Phone: +31 40 2577 284
Fax: +31 40 2577 330
emea.securitysystems@bosch.com
www.boschsecurity.com

Asia-Pacific:

Robert Bosch (SEA) Pte Ltd, Security Systems
11 Bishan Street 21
Singapore 573943
Phone: +65 6571 2600
Fax: +65 6571 2698
apr.securitysystems@bosch.com
www.boschsecurity.com

Represented by