



**BOSCH**

# **AUTODOME inteox 7000i**

**en**

User Manual



## Table of contents

<b>1</b>	<b>Introduction</b>	<b>6</b>
<b>1.1</b>	Systems requirements	<b>6</b>
<b>1.2</b>	Establishing the connection	<b>6</b>
<b>1.3</b>	Configuration with Project Assistant app	<b>6</b>
<b>1.4</b>	Password protection in camera	<b>7</b>
<b>2</b>	<b>System overview</b>	<b>8</b>
<b>2.1</b>	Live page	<b>8</b>
<b>2.2</b>	Playback	<b>9</b>
<b>2.3</b>	Configuration	<b>9</b>
<b>2.4</b>	Dashboard	<b>9</b>
<b>3</b>	<b>General</b>	<b>10</b>
<b>3.1</b>	Identification	<b>10</b>
<b>3.2</b>	User Management	<b>10</b>
<b>3.3</b>	Date/Time	<b>11</b>
<b>3.4</b>	Display Stamping	<b>12</b>
<b>3.5</b>	GB/T 28181	<b>15</b>
<b>4</b>	<b>Web Interface</b>	<b>16</b>
<b>4.1</b>	Appearance	<b>16</b>
<b>4.2</b>	'Live' functions	<b>17</b>
<b>5</b>	<b>Connectivity</b>	<b>19</b>
<b>5.1</b>	Cloud Services	<b>19</b>
<b>5.2</b>	Accounts	<b>19</b>
<b>5.3</b>	Accounts	<b>20</b>
<b>5.4</b>	DynDNS	<b>20</b>
<b>5.4.1</b>	Enable DynDNS	<b>20</b>
<b>5.4.2</b>	Provider	<b>20</b>
<b>5.4.3</b>	Host name	<b>20</b>
<b>5.4.4</b>	User name	<b>21</b>
<b>5.4.5</b>	Password	<b>21</b>
<b>5.4.6</b>	Force registration now	<b>21</b>
<b>5.4.7</b>	Status	<b>21</b>
<b>5.5</b>	DynDNS	<b>21</b>
<b>6</b>	<b>User Apps</b>	<b>22</b>
<b>6.1</b>	App Management	<b>22</b>
<b>7</b>	<b>Camera</b>	<b>23</b>
<b>7.1</b>	Installer Menu	<b>23</b>
<b>7.1.1</b>	Positioning	<b>24</b>
<b>7.2</b>	Scene Mode	<b>27</b>
<b>7.2.1</b>	Color	<b>28</b>
<b>7.2.2</b>	Picture Settings	<b>29</b>
<b>7.2.3</b>	Enhance	<b>31</b>
<b>7.2.4</b>	Scene Mode Scheduler	<b>32</b>
<b>7.3</b>	Encoder Profile	<b>32</b>
<b>7.4</b>	Encoder Streams	<b>35</b>
<b>7.5</b>	Encoder Statistics	<b>37</b>
<b>7.6</b>	Lens Settings	<b>37</b>
<b>7.7</b>	PTZ Settings	<b>38</b>
<b>7.8</b>	Pre-positions and Tours	<b>40</b>

7.9	Pre-position settings	41
7.10	Sectors	42
7.11	Miscellaneous	42
7.12	Audio	42
7.13	Pixel Counter	42
<b>8</b>	<b>Recording</b>	<b>43</b>
8.1	Introduction to recording	43
8.2	Storage Management	43
8.2.1	Device manager	43
8.2.2	Recording media	43
8.2.3	Activating and configuring storage media	44
8.2.4	Formatting storage media	44
8.2.5	Deactivating storage media	44
8.3	Recording Profiles	44
8.4	Maximum Retention Time	46
8.5	Recording Scheduler	46
8.6	Recording Status	47
8.7	Recording Statistics	47
8.8	Image Posting	47
<b>9</b>	<b>Alarm</b>	<b>49</b>
9.1	Alarm Connections	49
9.2	Video Content Analysis (VCA)	50
9.3	Audio Alarm	52
9.4	Alarm E-Mail	53
9.5	Alarm Inputs	54
9.6	Alarm Outputs	55
9.7	Alarm Task Editor	55
9.8	Alarm Rules	55
<b>10</b>	<b>Network</b>	<b>58</b>
10.1	Network Services	58
10.2	Network Access	58
10.3	Advanced	60
10.4	Network Management	61
10.4.1	UPnP	61
10.4.2	Quality of Service	61
10.5	Network Management	61
10.6	Multicast	62
10.7	CloudWatch	62
10.8	IPv4 Filter	63
<b>11</b>	<b>Service</b>	<b>64</b>
11.1	Maintenance	64
11.2	Licenses	65
11.3	Certificates	65
11.4	Logging	65
11.5	Diagnostics	65
11.6	System Overview	65
<b>12</b>	<b>Security and Safety Things</b>	<b>66</b>
12.1	Applications	66
12.1.1	Overview	66

---

<b>12.1.2</b>	Camera platform info	<b>66</b>
<b>12.1.3</b>	Crash reporting	<b>66</b>
<b>12.2</b>	Bosch camera interface	<b>66</b>
<b>12.3</b>	Legal	<b>66</b>
<b>13</b>	<b>Operation via the browser</b>	<b>67</b>
<b>13.1</b>	Live page	<b>67</b>
<b>13.1.1</b>	Pre-positions	<b>67</b>
<b>13.1.2</b>	AUX Control	<b>67</b>
<b>13.1.3</b>	Special Functions	<b>67</b>
<b>13.1.4</b>	Recording status	<b>67</b>
<b>13.1.5</b>	Recording live video	<b>68</b>
<b>13.1.6</b>	Audio communication	<b>68</b>
<b>13.1.7</b>	Storage, CPU and network status	<b>68</b>
<b>13.1.8</b>	Status icons	<b>69</b>
<b>13.2</b>	Playback	<b>70</b>
<b>13.2.1</b>	Selecting the recording stream	<b>70</b>
<b>13.2.2</b>	Searching for recorded video	<b>70</b>
<b>13.2.3</b>	Exporting recorded video	<b>70</b>
<b>13.2.4</b>	Track list	<b>70</b>
<b>13.2.5</b>	Controlling playback	<b>70</b>
<b>13.3</b>	Dashboard	<b>71</b>
<b>14</b>	<b>Recommended Use of Your Camera</b>	<b>72</b>
<b>15</b>	<b>Troubleshooting</b>	<b>74</b>
<b>15.1</b>	Physical reset button	<b>75</b>
<b>16</b>	<b>Status Codes</b>	<b>77</b>
<b>17</b>	<b>AUX Commands</b>	<b>78</b>
<b>18</b>	<b>Support</b>	<b>80</b>

---

# 1 Introduction

## 1.1 Systems requirements

- Computer with Intel Skylake processor or better
- Intel HD530 graphic card with performance that matches or is better than the resolution of the camera
- Windows 7 (or newer) operating system
- Network access
- Web browser:
  - Internet Explorer version 11 (or newer)
  - Mozilla Firefox
- Application software, for example, Video Security Client, Bosch Video Client, BVMS, or Project Assistant app.
- DirectX 11
- MPEG-ActiveX 6.34 (or newer) [required to see, in your browser, live images from the camera]
- Configuration Manager 7.0 (or newer)

## 1.2 Establishing the connection

The unit must have a valid IP address to operate on your network and a compatible subnet mask.

By default, DHCP is pre-set at the factory to **On plus Link-Local** so a DHCP server assigns an IP address or, if no DHCP server is available, a link-local address (auto-IP) is assigned within the range 169.254.1.0 to 169.254.254.255.

You can use IP Helper or Configuration Manager to find the IP address. Download the software from <http://downloadstore.boschsecurity.com>.

1. Start the Web browser.
2. Enter the IP address of the unit as the URL.
3. During initial installation, confirm any security questions that appear.

**Note:**

If you cannot connect, the unit may have reached its maximum number of connections.

Depending on the device and network configuration, each unit can have up to 50 web browser connections, or up to 100 connections via Bosch Video Client or BVMS.

## 1.3 Configuration with Project Assistant app

You can also use the Project Assistant app to complete the initial configuration of the camera. In order to use this device with the Project Assistant app by Bosch, you must download the app from the Bosch Download Store, from Google Play, or from the Apple Store.

You can access the app in several ways:

- Scan the QR code from the QIG.
- From [www.boschsecurity.com](http://www.boschsecurity.com), select Support > Apps and Tools > Online Apps - Video > Bosch Project Assistant app. Select the appropriate operating system, and then click the appropriate button to download and install the app.
- From Google Play Store ([play.google.com](http://play.google.com)), search for Bosch Project Assistant. Select the app from the list. Click the Install button.
- From Apple Store ([itunes.apple.com](http://itunes.apple.com)), search for Bosch Project Assistant. Select the app from the list. Click the appropriate button to download and install the app.

## 1.4 Password protection in camera

The device is password-protected. The first time that any user accesses the device, the device will prompt the user to set a password at the service level.

The camera requires a strong password. Follow the prompts in the dialog box, which specifies what is required. The system measures the strength of the password that you enter.

When you use Configuration Manager to access your device for the first time, you must set the initial password of the device in Configuration Manager. The Users section (General > Unit Access > Users) displays the message, "Before you can use this device you have to secure it with an initial password."

**Note:** After you set the initial password, a "lock" icon appears next to the device name in the **Devices** list in Configuration Manager.

You can also launch the device webpage directly. In the device webpage, an initial password page appears, displaying input fields and a password strength gauge.

Enter the user name ("**service**") and a password in the appropriate fields. Refer to the section **User Management** for more information.

After a service-level password is set for the device, the device displays a dialog box that prompts users to enter the user name ("**service**") and the service-level password every time that they access the device.







1. Fill in the fields **User name** and **Password**.
2. Click **OK**. If the password is correct, the desired page appears.

## 2 System overview

When a connection is established, the **Live** page shows.

The page shows the live video from the camera.



The application bar near the top of the page, below the name of the product or of the product family, displays the following icons:

Icon	Description	Function
	<b>Live</b>	View the live video stream.
	<b>Playback</b>	Play back recorded sequences. This link is only visible if a storage medium has been configured for recording. (With VRM recording, this option is not active.)
	<b>Configuration</b>	Configure the device.
	<b>Dashboard</b>	See detailed system information.
	<b>Links</b>	Navigate to the Bosch download store.
	<b>Logout</b>	Log out of the device.
	<b>Help on this page?</b>	Get context-sensitive help for the page that you are seeing.



### 2.1 Live page

The **Live** page is used to display the live video stream and control the unit.

Below the live video is a field with the date and time. Below the date / time field is a row of icons related to the video feed.

Icon	Description	Function
	Full-screen video	See the selected stream in full-screen mode; press <b>Esc</b> on the keyboard to return to the normal viewing window.
	Save snapshots	Save individual images from the displayed live video stream in JPEG format on the computer's hard drive. The storage location depends on the configuration of the camera.
	Start recording	Save video sequences from the displayed live video stream on the computer's hard drive. The sequences are recorded at the resolution specified in the encoder configuration. The storage location depends on the configuration of the camera.



Icon	Description	Function
	Start Video Security App	Start the app and use It to view live images, to configure and to operate the device from any location.
	Show latest event	Open the Playback page to see the last recorded important events.

## 2.2 Playback

The **Playback** page is used for playing back recorded sequences.

## 2.3 Configuration

The **Configuration** page is used to configure the unit and the application interface.

### Making Changes

Each configuration screen shows the current settings. You can change the settings by entering new values or by selecting a predefined value from a list field.

Not every page has a **Set** button. Changes to pages without a **Set** button are set immediately. If a page does show a **Set** button, you must click the **Set** button for a change to take effect.



### Notice!

Save each change with the associated **Set** button.

Clicking the **Set** button saves the settings only in the current field. Changes in any other fields are ignored.

Some changes only take effect after the unit is rebooted. In this case, the **Set** button changes to **Set and Reboot**.

1. Make the desired changes.
2. Click the **Set and Reboot** button. The camera reboots and the changed settings are activated.

All settings are backed up in camera memory so they are not lost even if the power fails. The exception is the time settings, which are lost after 1 hour without power if no central time server is selected.

## 2.4 Dashboard

The **Dashboard** page is used to display detailed information about the device.

The **Dashboard** is only visible in the application bar if the **Show 'Dashboard'** option is enabled by a service-level user in the **Configuration** -> **Web Interface** -> **Appearance** page.

## 3 General

### 3.1 Identification

#### Device name

Enter a unique, unambiguous name for the device (for example, the installation location of the device). This name should be easy to identify in a list of devices in your system. The device name is used for the remote identification of a unit, such as in the event of an alarm.

Do not use any special characters, for example **&**, in the name. Special characters are not supported by the system's internal management.

#### Device ID

Enter a unique identifier for the device. This ID is additional identification for the device.

#### Video name

Enter a name for the video (for example, HDR ON).

#### Host name

Enter a host name.

#### Initiator extension

Add text to an initiator name to make identification easier in large iSCSI systems. This text is added to the initiator name, separated from it by a full stop. (You can see the initiator name in the System Overview page.)

### 3.2 User Management

The section **Allowed authentication modes** provides information about the authentication modes set in the camera. A checkmark appears in the checkbox to the left of the mode if the mode is set. If the mode is not set, the phrase, "No certificate installed" appears to the right of the mode name.

#### Password

This field indicates if a password is set for the camera.

#### Certificate

A check mark in this check box indicates that at least one certificate is loaded onto the camera. If no certificates are loaded, then "No certificate installed" appears to the right of the text.

The Escript certificate is a root certificate for Bosch Security Systems that proves that the device meets the following criteria:

- It originates from a Bosch factory that is a secure environment.
- It has not been tampered with.

Escript is a Bosch company and Certificate Authority (CA).

#### Active directory server (ADFS)

A check mark in this check box indicates that the camera uses an active directory server. If the camera does not use ADFS, then "No certificate installed" appears to the right of the text.

#### Password management

A password prevents unauthorized access to the device. You can use different authorization levels to limit access.

Proper password protection is only guaranteed when all higher authorization levels are also protected with a password. Therefore, you must always start from the highest authorization level when assigning passwords.

You can define and change a password for each authorization level if you are logged into the "service" user account.

The device has three authorization levels: service, user, and live.

- service is the highest authorization level. Entering the correct password gives access to all the functions and allows all configuration settings to be changed.
- user is the middle authorization level. At this level you can operate the device, play back recordings, and also control camera, for example, but you cannot change the configuration.
- live is the lowest authorization level. At this level you can only view the live video image and switch between the different live image displays.

A fourth user group, **VCA configuration**, has the privilege to configure VCA only.

Note: Configuration and use of this user group is available only in Configuration Manager (7.20 or later).

#### To edit a password

To edit a password, click the pencil icon to the right of the column **Type** for the appropriate **User name**.

#### To create a new user

To create a new user, click **Add**.

In the box **User**, fill in the fields. For Group, select the appropriate authorization level. For **Type**, select either **Password** (for a new password) or **Certificate** (for a certificate that the new user is authorized to use).

**Note:** Use a maximum of 19 characters. Do not use special characters.

#### Confirm password

In each case, enter the new password a second time to eliminate typing mistakes.



#### Notice!

A new password is only saved when you click the **Set** button. You should therefore click the **Set** button immediately after entering and confirming a password.

## 3.3

### Date/Time

#### Date format

Select the required date format from the dropdown menu.

#### Device date/Device time



#### Notice!

Make sure that recording is stopped before synchronizing to the PC.

If there are multiple devices operating in your system or network, it is important to synchronize their internal clocks. For example, it is only possible to identify and correctly evaluate simultaneous recordings when all units are operating on the same time.

1. Enter the current date. Since the unit time is controlled by the internal clock, there is no need to enter the day of the week - it is added automatically.
2. Enter the current time or click the **Sync to PC** button to copy your computer's system time to the camera.

**Note:** It is important that the date/time is correct for recording. An incorrect date/time setting could prevent correct recording.

#### Device time zone

Select the time zone in which the system is located.

### Daylight saving time

The internal clock can switch automatically between normal and daylight saving time (DST). The unit already contains the data for DST switch-overs for many years in advance. If the date, time and zone have been set up correctly, a DST table is automatically created. If you decide to create alternative daylight saving time dates by editing the table, note that values occur in linked pairs (DST start and end dates).

First, check the time zone setting. If it is not correct, select the appropriate time zone and click **Set**.

1. Click **Details** to edit the DST table.
2. Select the region or the city which is closest to the system's location from the list box below the table.
3. Click **Generate** to fill the table with the preset values from the unit.
4. Click one of the entries in the table to make changes. The entry is highlighted.
5. Click **Delete** to remove the entry from the table.
6. Choose other values from the list boxes under the table, to change the selected entry. Changes are immediate.
7. If there are empty lines at the bottom of the table, for example after deletions, add new data by marking the row and selecting values from the list boxes.
8. When finished, click **OK** to save and activate the table.

### Time server address

The camera can receive the time signal from time server using various time server protocols, and then use it to set the internal clock. The unit polls the time signal automatically once every minute.

Enter the IP address of a time server here.

You can choose to have the DHCP server give a time server date by selecting the **Overwrite by DHCP** option.

### Time server type

Select the protocol that is supported by the selected time server.

- Select **Time protocol** if the server uses the protocol RFC 868.
- The **SNTP protocol** supports a high level of accuracy and is required for special applications and subsequent function extensions.
- Select **TLS protocol** if the server uses the RFC 5246 protocol.
- Select **Off** to disable the time server.

Click **Set** to apply the changes.

## 3.4 Display Stamping

Various overlays or “stamps” in the video image provide important supplementary information. These overlays can be enabled individually and are arranged on the image in a clear manner.

### Camera name stamping

This field sets the position of the camera name overlay. It can be displayed at the **Top**, at the **Bottom** or at a position of your choice that you can then specify using the **Custom** option. Or it can be set to **Off** for no overlay information.

1. Select the desired option from the list.
2. If you select the **Custom** option, additional fields are displayed where you can specify the exact position (**Position (XY)**).
3. In the **Position (XY)** fields, enter the values for the desired position.

Optionally, tick the **Underlay with full-width bar** box to place a full-width background-bar beneath the time stamp.

### Logo

To place a logo on the image, select and upload an uncompressed .bmp file with a maximum size of 128x128 pixels and 256 colors to the camera. Its position on the image can then be selected.

### Logo position

Select the position for the logo on the OSD: **To the left of the name, To the right of the name, or Logo only.**

Select **Off** (the default value) to disable logo positioning.

### Time stamping

This field sets the position of the time overlay. It can be displayed at the **Top**, at the **Bottom** or at a position of your choice that you can then specify using the **Custom** option. Or it can be set to **Off** for no overlay information.

1. Select the desired option from the list.
2. If you select the **Custom** option, additional fields are displayed where you can specify the exact position (**Position (XY)**).
3. In the **Position (XY)** fields, enter the values for the desired position.

### Display milliseconds

If necessary, you can also display milliseconds. This information can be useful for recorded video images; however, it does increase the processor's computing time. Select **Off** if you do not need to display milliseconds.

### Live video indicator

Select **On** to display the **Live video indicator**, an icon that pulses on the OSD to show that the video stream is live.

Select **Off** to hide the **Live video indicator**.

### Alarm mode stamping

Select **On** to display a text message overlay in the image in the event of an alarm. It can be displayed at a position of your choice that you can then specify using the **Custom** option. Or it can be set to **Off** for no overlay information.

1. Select the desired option from the list.
2. If you select the **Custom** option, additional fields are displayed where you can specify the exact position (**Position (XY)**).
3. In the **Position (XY)** fields, enter the values for the desired position.

### Alarm message

Enter the message to be displayed in the image in the event of an alarm. The maximum text length is 31 characters.

### Title OSD

OSD titles can be displayed at a position of your choice.

Select **On** to display sector or pre-position title overlays continuously in the image.

Select **Momentary** to display sector or pre-position title overlays for a few seconds.

1. Select the desired option from the list.
2. Specify the exact position (**Position (XY)**).
3. In the **Position (XY)** fields, enter the values for the desired position.

Select **Off** to deactivate the display of overlay information.

### Camera OSD

Select **On** to momentarily display camera response information, such as Digital Zoom, Iris open/close, and Focus near/far overlays in the image. Select **Off** to display no information.

1. Select the desired option from the list.

2. Specify the exact position (**Position (XY)**).
3. In the **Position (XY)** fields, enter the values for the desired position.

#### **Title region**

Select **On** to set or to edit the position of the title region on the OSD.

The fields **Position (XY)** and **(0...255)** appear.

1. In the field **Position (XY)**, specify the exact position. (The default is 10.)
2. In the field **(0...255)**, enter the position range. (The default is 176).

Select **Off** to hide the region from view.

#### **Telemetry region**

Select **On** to set or to edit the position of the telemetry information (azimuth and elevation (pan/tilt position)) and the zoom factor on the OSD. Refer to the section "PTZ Settings, page 38" to set the pan and tilt limits.

The fields **Position (XY)** and **(0...255)** appear.

1. In the field **Position (XY)**, specify the exact position. (The default is 10.)
2. In the field **(0...255)**, enter the position range. (The default is 176).

Select **Off** to hide the region from view.

#### **Feedback region**

Select **On** to set or to edit the position of system feedback messages (including message for camera settings such as focus, iris, and zoom level) on the OSD. Refer to the section "Lens Settings" to configure these settings.

The fields **Position (XY)** and **(0...255)** appear.

1. In the field **Position (XY)**, specify the exact position. (The default is 10.)
2. In the field **(0...255)**, enter the position range. (The default is 176).

Select **Off** to hide the region from view.

#### **Transparent background**

Check this box to make transparent the stamp background on the image.

#### **Text color**

Select the color for the alarm message to be displayed in.

#### **Background color**

Select the background color for the alarm message to be displayed in.

If you have enabled the **Transparent background** option, the background color is not displayed in the OSD.

#### **Stamping size**

Select the desired font size of the overlays on the OSD: **Normal** or **Large**.

#### **Video authentication**

Select from the **Video authentication** drop-down box a method for verifying the integrity of the video.

If you select **Watermarking**, all images are marked with an icon. The icon indicates if the sequence (live or saved) has been manipulated.

If you want to add a digital signature to the transmitted video images to ensure their integrity, select one of the cryptographic algorithms for this signature.

#### **Signature interval [s]**

For certain **Video authentication** modes, enter the interval (in seconds) between insertions of the digital signature.

## 3.5 GB/T 28181

This page allows you to set the parameters for conformance to the GB/T 28181 national standard “Security and protection video monitoring network system for information transport, switch and control”. This standard is specifically for China.

### **Enable**

Select this checkbox to enable the system to use the other parameters on this page in accordance with the GB/T 28181 national standard.

### **H.264 elementary stream**

Select this checkbox to select or to enable the H.264 elementary stream.

### **Registration timeout**

Enter a value (in milliseconds) for the registration timeout. The default is 3600.

### **Heartbeat timeout**

Enter the value (in seconds) for the heartbeat timeout. The default is 15.

### **Server ID**

Enter the ID of the server.

### **Server IP address**

Enter the server IP address.

### **Server port**

Enter the number of the server port. The default is 0.

### **Device ID**

Enter the ID of the device.

### **Device port**

Enter the number of the device port. The default is 5060.

### **Password**

Enter the appropriate password.

### **Alarm device ID**

Enter the ID of the alarm device.

## 4 Web Interface

### 4.1 Appearance

You can adapt the appearance of the web interface and change the website language to meet your requirements.

You can use GIF or JPEG images to replace the company and device logos. The image can be stored on a web server.

Make sure that a connection to the web server is always available to display the image. The image files are not stored on the device.

To use the original graphics, delete the entries in the **Company logo** and **Device logo** fields.

#### Website language

Select the language for the user interface.

The default language is English. After selecting a different language, click the **Set** button. The page refreshes automatically. The GUI now displays field names and options as well as OSD messages in the selected language.

#### Company logo

To replace the company's logo in the top-right part of the window, enter the path to a suitable image in this field. The image file must be stored on a web server.

#### Device logo

To replace the device name in the top-left part of the window, enter the path to a suitable image in this field. The image file must be stored on a web server.



#### Notice!

If you want to use the original image again, delete the entries in the fields **Company logo** and **Device logo**.

#### Show VCA metadata

When video content analysis (VCA) is activated, additional information is displayed in the live video stream. With the MOTION+ analysis type, for example, the sensor fields in which motion is recorded are marked with yellow rectangles.

Using Essential Video Analytics or Intelligent Video Analytics, the outlines of detected objects are displayed in following colors:

- Red: Objects that generate an alarm event under the current settings appear on the camera image inside a red outline.
- Orange: An object that has triggered one alarm event but does not generate another appears inside an orange outline (example: object has crossed a line). During forensic search, an object that triggers an alarm event has an orange outline from the beginning.
- Yellow: Objects that are detected as moving but do not generate an alarm event under the current settings appear inside a yellow outline.

#### Show VCA trajectories

The trajectories (motion lines of objects) from the video content analysis are displayed in the live video image if a corresponding analysis type is activated. The trajectory is shown as a green line following the object base point.

#### Show overlay icons

Select this check box to show overlay icons on the live video image.

#### Show VCA items

Shows alarm fields, lines and routes configured for the video analytics in the following colors:



- Green: Fields, lines and routes used in a task are displayed in green. They can be edited but not deleted.
- Red: Fields, lines and routes currently in alarm mode are displayed in red.

**Show 'Dashboard'**

Select this checkbox to enable the **Dashboard** in the application bar.

**Secure cookies**

Select this checkbox to secure the cookies sent through the camera.

**Notice!**

If cookies are secured, authentication forwarding to MPEG ActiveX and the Video Security App is prohibited.

**Latency mode**

Select the required latency mode:

- **Low delay:** Default mode. Provides marginal buffering to display fluent video under normal network conditions.
- **Smooth video:** Allows the buffer to automatically adjust to cover network jitter, inducing higher latency.
- **No buffering:** Shows video as it is received by the decoder with minimum latency. Allows the video to jerk if there is network jitter.

**Video buffer**

The value shown is calculated from the **Latency mode** setting. It cannot be changed.

**JPEG resolution**

Select the size of the JPEG image on the **Live** page. Options are **Small**, **Medium**, **Large**, 720p, 1080p, and **Resource based**.

**JPEG interval**

You can specify the interval at which the individual images should be generated for the M-JPEG image on the **Live** page.

**JPEG quality**

You can specify the quality at which the JPEG images appear on the **Live** page.

## 4.2

### 'Live' functions

On this page you can adapt the functions on the **LIVE** page to your requirements. You can choose from a variety of different options for displaying information and controls.

1. Check the box for the items that are to be made available on the **LIVE** page. The selected items are indicated by a check mark.
2. Check whether the required functions are available on the **LIVE** page.

**Transmit audio**

You can only select this option if audio transmission is actually switched on (see Audio). The audio signals are sent in a separate data stream parallel to the video data, and so increase the network load. The audio data are encoded according to G.711 and require an additional bandwidth of approx. 80 kbps per connection in each direction.

**Auto logout time [min]**

Set a time frame (in minutes) for the automatic logout. Default value is 0 (no automatic logout).

**Show alarm inputs**

Select this checkbox if you want the alarm inputs to appear in the **Digital I/O** section of the **Live** page.

**Show alarm outputs**

Select this checkbox if you want the alarm outputs to appear in the **Digital I/O** section of the **Live** page.

**I-frames only stream**

Here you can specify whether the **LIVE** page displays a viewing tab for an I-frame only stream.

**Show 'Pre-positions'**

Here you can specify whether the section **Pre-positions** of the **Live** page displays a drop-down box with the list of scenes set in the section **Camera > Pre-positions and Tours** of the **Configuration** page.

**Show 'AUX Control'**

Here you can specify whether the **Live** page displays the section **Show 'AUX Control'**.

Here you can specify whether the **Live** page displays the section **Special Functions**.

**Path for JPEG and video files**

Enter the path for the storage location of individual images and video sequences saved from the **Live** page.

**Video file format**

Select a file format for the live page display. The MP4 format does not include metadata.

## 5 Connectivity

### 5.1 Cloud Services

#### Bosch Remote Portal

##### Operation

The operation mode determines how the camera communicates with the Bosch Remote Portal.

- Select **On** to poll the server constantly.
- Select **Off** to block polling.

##### Connectivity state

This field identifies any cloud-based services with which the camera communicates.

- If you have registered the device on a cloud-based service such as Bosch Remote Portal, then this field identifies this fact (“**Connected**”).

**Note:** The button ( ) to connect to the device with that service is active.

- If you have not registered the device, then the message, “**Not available. When 'Operation' is set to 'Auto', 'Automatic IP assignment (DHCP)' must be active to connect to the Bosch Remote Portal**” appears.

**Note:** The button ( ) to connect to the device with that service is not active.

### 5.2 Accounts

Four separate accounts can be defined for posting and recording export.

#### Type

Select FTP, Dropbox, Amazon S3, or Amazon Kinesis for the account type.

#### Account name

Enter an account name to be shown as the target name.

#### Access key ID and Secret access key

Enter the correct access key ID and secret access key information.

Access keys consist of two parts: an access key ID (for example, AKIAIOSFODNN7EXAMPLE) and a secret access key (for example, wJalrXUtnFEMI/K7MDENG/bPxrFiCYEXAMPLEKEY).

Like a user name and password, you must use both the access key ID and secret access key together to authenticate your requests. Manage your access keys as securely as you do your user name and password.

#### For account type Amazon Kinesis:

##### Region

Enter the region that the camera resides in.

##### Stream name

Enter the stream name assigned to the camera.

#### For account type Amazon S3:

##### Bucket name

Enter a bucket name.

Buckets are one of the Amazon S3 resources for which you can allow or deny permissions.

##### Region

Enter the region that the camera resides in.

##### S3 storage URL

Enter the URL path for the Amazon Simple Storage Service (Amazon S3).

**Camera ID**

Enter a unique identifier for the camera as an additional means of identification.

**Fragment duration [s]**

Enter the duration, in seconds, for each fragment.

Click **Set** to apply the changes.

## 5.3

### Accounts

Four separate accounts can be defined for posting and recording export.

**Type**

Select either FTP or Dropbox for the account type.

Before using a Dropbox account ensure that the time settings of the device have been correctly synchronized.

**Account name**

Enter an account name to be shown as the target name.

Note: The fields that appear next depend on the option that you select in the field **Type**.

**IP address**

Enter the IP address of the server on which you wish to save the JPEG images.

**Login**

Enter the login ID for the server.

**Password**

Enter the password that gives you access to the server. To verify the password, click the Check button to the right.

**Path**

Enter the exact path on which you wish to post the images on the server. To browse for the correct path, click the Browse button to the right.

**Maximum bit rate**

Enter the maximum bit rate for the JPEG images (in kbps).

**Encryption**

Tick the box to use a secure FTP over TLS connection.

## 5.4

### DynDNS

#### 5.4.1

**Enable DynDNS**

A dynamic Domain Name Service (DNS) allows you to select the unit via the Internet using a host name, without having to know the current IP address of the unit. You can enable this service here. To do this, you must have an account with one of the dynamic DNS providers and you must register the required host name for the unit on that site.

**Note:**

For information about the service, registration process and available host names refer to the provider.

#### 5.4.2

**Provider**

Select your dynamic DNS Provider from the drop-down list.

#### 5.4.3

**Host name**

Enter the host name registered for the unit.

**5.4.4 User name**  
Enter the user name you registered.

**5.4.5 Password**  
Enter the password you registered.

**5.4.6 Force registration now**  
Force the registration by transferring the IP address to the DynDNS server. Entries that change frequently are not provided in the Domain Name System. It is a good idea to force the registration when setting up the device for the first time. Only use this function when necessary and no more than once a day, to avoid the possibility of being blocked by the service provider. To transfer the IP address of the device, click the **Register** button.

**5.4.7 Status**  
The status of the DynDNS function is displayed here for information purposes; these settings cannot be changed.

## 5.5 DynDNS

### Enable DynDNS

A dynamic Domain Name Service (DNS) allows you to select the unit via the Internet using a host name, without having to know the current IP address of the unit. You can enable this service here. To do this, you must have an account with one of the dynamic DNS providers and you must register the required host name for the unit on that site.

#### Note:

For information about the service, registration process and available host names refer to the provider.

#### Provider

Select your dynamic DNS Provider from the drop-down list.

#### Host name

Enter the host name registered for the unit.

#### User name

Enter the user name you registered.

#### Password

Enter the password you registered.

#### Force registration now

Force the registration by transferring the IP address to the DynDNS server. Entries that change frequently are not provided in the Domain Name System. It is a good idea to force the registration when setting up the device for the first time. Only use this function when necessary and no more than once a day, to avoid the possibility of being blocked by the service provider. To transfer the IP address of the device, click the **Register** button.

#### Status

The status of the DynDNS function is displayed here for information purposes; these settings cannot be changed.

Click **Set** to apply the changes.

---

## **6 User Apps**

### **6.1 App Management**

You can install a maximum of 16 user apps.

Select the appropriate app number and then select the name from the drop-down list.

## 7

## Camera

### 7.1

### Installer Menu

#### Sensor mode

The sensor mode specifies the base resolution and frame rates for the image quality settings. Fast moving scenes use more frame rates (50 fps or 60 fps) for better image quality than slow moving scenes. Adjust this setting as necessary.

This higher resolution (HD 1080p) gives maximum detail in these scenes, but can result in motion artifacts for fast-moving objects because of the lower frame rates.

Some types of light can show flickering in the image when the frame rate is not synchronized with the mains power frequency. To avoid this, the sensor mode frame rate should be in line with the power frequency:

- 50Hz: 25 or 50 fps
- 60Hz: 30 or 60 fps

Select **On** to output a mirror image of the camera picture.

**Note:** Privacy masks are not supported in mirror image mode.

#### Coding standard

Select the encoding mode:

- H.264
- H.265
- **H.265 (no B-frames)**

**H.265 (no B-frames)** is a restrictive mode for the encoder where it only supports I and P frames. This decreases calculation power so that there can be a higher frame rate (for example, 30 fps for a camera that might be restricted to 25 fps).

#### Orientation

Reverses the image 180° (ideal when mounting upside down). Set the orientation to Normal (default) or Inverted.



#### Caution!

The camera disables the Privacy Mask function if the orientation is set to Inverted.

#### System controller settings

Click the Default button to restore all camera settings to their original defaults.

#### Reboot device

Click the **Reboot** button to reboot the camera. There is a ten (10) second pause before the dome starts its homing phase. During the homing phase, the camera pans left and right and tilts up and down. It also adjusts the lens focus. The entire homing phase lasts approximately 40 seconds.

#### Reboot device

Click **Restore** to restore the factory defaults of the device.

**Note:** Clicking this button also clears the service-level password. Operators must reset the password before doing anything else.

#### Factory defaults

Click **Defaults** to restore the factory defaults for the camera. A confirmation screen appears. Allow several seconds for the camera to optimize the picture after a reset.

Click **Confirm** in each dialog box that opens to complete a factory reset of the device.

This action deletes all third-party apps and resets all settings to defaults (including network settings).

**Caution!**

Do not remove power to the unit during a factory default or a firmware update. Wait at least two minutes for the default process to complete. If the unit appears to be "frozen" after two minutes, then reboot the unit. Refer to Troubleshooting for more details.

**7.1.1****Positioning**

The **Positioning** feature describes the location of the camera and the perspective in the camera's field of view.

Perspective information is essential to Video Analytics, as it enables the system to compensate for the illusory smallness of distant objects.

Only through use of perspective information is it possible to distinguish objects such as persons, bicycles, cars and trucks, and accurately compute their real size and speeds as they move through 3D space.

However, to calculate perspective information accurately, the camera must be directed at a single, flat horizontal plane. Multiple and inclined planes, hills, stairs can falsify perspective information and produce incorrect object information such as size and speed.

**Mounting position**

The mounting position describes the perspective information that is also often called calibration.

In general, the mounting position is determined by the parameters of the camera such as height, roll angle, tilt angle, and focal length.

The height of the camera must always be entered manually. Whenever possible, roll angle and tilt angle are provided by the camera itself. The focal length is provided, if the camera has a built-in lens.

Select the appropriate mounting position of the camera. Options that appear depend on the type of camera.

**Height [m]**

The height describes the vertical distance from the camera to the ground plane of the captured image. Typically the elevation of the mounted camera above the ground.

Enter the height in meters of the position of the camera.

**Sketch**

The **Sketch** functionality offers an additional, half-automatic calibration method. This calibration method allows you to describe the perspective in the camera's field of view by drawing vertical lines, ground lines, and ground angles in the camera image and entering the correct size and angle. Use the **Sketch** functionality if the result of the automatic calibration is not sufficient.

You can also combine this manual calibration with the values for roll angle, tilt angle, height and focal length calculated by the camera or entered manually.

Click to improve the automatic calibration. The **Sketch-based calibration** window is displayed.

**VCA Profile**

Select the appropriate profile.

**Global**

Select the **Global** check box to use the global, overall calibration for all AUTODOME and MIC cameras.

Alternatively, clear the **Global** check box to obtain a local calibration and overwrite the global calibration for the selected profile. To do this, select the VCA profile before.





### Notice!

The **Sketch** functionality is only available for configured and assigned pre-positions. For AUTODOME and MIC cameras, configure the pre-positions of the camera and assign the pre-positions to one of the available 16 VCA profiles before calibration with **Sketch**. Applications are pre-positions of cameras directed towards different ground planes, an optimized calibration for inclined ground planes or large focal lengths. A local pre-position calibration does not change the global calibration. It is also possible to calibrate pre-positions without entering a global calibration.

### Calculate

Select the **Calculate** check box to obtain the roll angle, tilt angle, height and focal length from the sketched calibration elements - vertical lines, ground lines and angles - you have placed in the camera.

Clear the **Calculate** check box to enter a value manually or to refresh to the values provided by the camera itself.

### Tilt angle [°] / Roll angle [°]

Enter the angle manually, or click the refresh icon to obtain values that are provided by any sensors that the camera may have. As an alternative, select the **Calculate** check box to get values based on the calibration elements that are marked on the image.

### Height [m]



Enter the height manually, or click the refresh icon to obtain values that are provided by any sensors that the camera may have. As an alternative, select the **Calculate** check box to obtain values based on the calibration elements that are marked on the image.

### Focal length [mm]

Enter the focal length manually, or click the refresh icon to obtain values that are provided by any sensors that the camera may have. As an alternative, select the **Calculate** check box to obtain values based on the calibration elements that are marked on the image.

### Calibrating cameras using the Sketch-based calibration window

To determine non-automatically set values:

1. Enter the value for tilt angle, roll angle, height and focal length if the value is known, for example, by measuring the height of the camera above the ground, or reading the focal length from the lens.
2. For each value that is still unknown, select the **Calculate** check box, then place a calibration element on the camera image. Use these calibration elements to trace individual outlines of the displayed environment in the camera image and define the position and size of these lines and angles.
  - Click  to place a vertical line across the image. A vertical line corresponds to a line that is perpendicular to the ground plane, such as a door frame, edge of a building or a lamp post.
  - Click  to place a line across the ground in the image. A line on ground corresponds to a line that is on the ground plane, such as a road marking.
  - Click  to place an angle on the ground in the image. The angle on ground represents an angle lying on the horizontal ground plane, such as the corner of a carpet or parking bay markings.
3. Adjust the calibration elements to the situation:

- Enter the real size of a line or angle. To do this, select the line or angle, then enter the size in the corresponding box.  
**Example:** You have placed a line on ground across the lower side of an automobile. You know that the automobile is 4 m long. Enter 4 m as the length of the line.
- Adjust the position or length of a line or angle. To do this, drag the line or angle or move the end points to the desired position in the camera image.
- Remove a line or angle. To do this, select the line or angle, then click the trash can icon.

**Note:**

**Blue** lines indicate calibration elements added by you.

**White** lines represent the element as it should be positioned on the camera image based on the current calibration results or the determined calibration data.

**Horizon**

If the values correspond, areas on the camera image have a colored background.

**blue:** This area corresponds to the sky. The bottom line of the blue area represents the horizon. Objects that are detected in the blue area cannot be filtered correctly by size or speed.

If the camera is installed at a relatively low height in a building, for example, this display is not required, because the entire area covered by the camera is below the horizon.

**Notice!**

If the distance to the camera (geolocation) is not relevant, it is enough to determine height and focal length in relation to each other. This allows a simple calibration by marking 2-3 persons - each with a vertical line - and setting their size. 1,80 m (71 in.) for all is sufficient. Use at least one person in the front and one person in the background of the image for best results.

**Coordinate system**

The **Coordinate system** feature describes the position of the camera in a local **Cartesian** or the global **WGS 84** coordinate system. The camera and the objects tracked by the video analytics are displayed on a map.

Select the coordinate system and enter the appropriate values in the additional input fields that appear depending on the coordinate system selected.

**Cartesian**

The Cartesian coordinate system describes each point in the space by a combination of the position on three orthogonal axes X, Y and Z. A right-handed coordinate system is used, where X and Y span the ground plane and Z describes the elevation of the ground plane.

**X [m]**

The location of the camera on the ground on the X-axis.

**Y [m]**

The location of the camera on the ground on the Y-axis.

**Z [m]**

The elevation of the ground plane. To determine the elevation of the camera, add the **Z [m]** value and the **Height [m]** value of the camera.

**WGS 84**

The WGS 84 coordinate system is a spherical coordinate system description of the world and used in many standards including GPS.

**Latitude**

Latitude is the north-south position of the camera in the spherical coordinate system WGS 84.

**Longitude**

Longitude is the east-west position of the camera in the spherical coordinate system WGS 84.

**Ground level [m]**

The elevation of the ground above sea level. To determine the elevation of the camera, add the **Ground level [m]** value and the **Height [m]** value of the camera.

**Azimuth [°]**

The orientation of the camera in a counter-clockwise angle starting with 0° in the east (WGS 84) or on the X-axis (**Cartesian**). If the camera is directed towards the north (WGS 84) or the Y-axis (Cartesian), the azimuth is 90°.

## 7.2

### Scene Mode

A scene mode is a collection of image parameters that are set in the camera when that particular mode is selected (installer menu settings are excluded). Several pre-defined modes are available for typical scenarios. After a mode has been selected, additional changes can be made through the user interface.

Customize the mode, if necessary, for the specific requirements of the site by selecting different values for the fields below.

**Current mode**

Select the mode you wish to use from the drop-down menu.

**– Standard**

This mode is optimized for most standard scenes both indoor and outdoor.

**– Sensitivity boost**

This mode provides maximum sensitivity in low light scenes by using longer exposure times, resulting in bright images even in extreme low light.

**– Fast movement**

This mode is used for monitoring fast moving objects like cars in traffic scenes. Motion artifacts are minimized and the image is optimized for a sharp and detailed picture in color and monochrome.

**– Vibrant**

This mode provides a more vivid image with increased contrast, sharpness, and saturation.

**– Color Only (Traffic)**

In this mode, the camera does not switch to monochrome mode at low light levels. The mode is optimized to minimize motion artifacts and to capture the color of vehicles/pedestrians and traffic lights, even at night, for scenarios such as city surveillance and traffic monitoring.

**– Indoor**

This mode is ideal for indoor applications where lighting is constant and does not change.

Auto white balance will be mainly focused on low color temperature 3200K.

**– Custom mode #1**

If necessary, select a custom mode.

**– Custom mode #2**

If necessary, select a second custom mode.

**Mode ID**

The name of the selected mode is displayed.

**Copy mode to**

Select the mode from the drop-down menu to which you wish to copy the active mode.

**Note:** To restore the default setting of all scene modes, you must click the SC setting.

**Restore mode defaults**

Click **Restore Mode Defaults** to restore the factory default modes. Confirm you decision.

**7.2.1**

**Color**

**Brightness (0...255)**

Adjust the brightness with the slider from 0 to 255.

**Contrast (0...255)**

Adjust the contrast with the slider from 0 to 255.

**Saturation (0...255)**

Adjust the color saturation with the slider from 0 to 255.

- **Basic auto** mode allows the camera to continually adjust for optimal color reproduction using an average reflectance method. This is useful for indoor light sources and for colored LED light illumination.
- **Standard auto** mode allows the camera to continually adjust for optimal color reproduction in an environment with natural light sources.
- **Dominant color auto** mode takes into account any dominant color in the image (for example, the green of a football pitch or of a gaming table) and uses this information to obtain a well balanced color reproduction.
- In **Manual RGB** mode, the Red, Green, and Blue gain can be set manually to a desired position.

Click **Hold** to put ATW on hold and save the current color settings. The mode changes to manual.

The table below identifies the options available in the field **White balance** and the additional fields that appear depending on the options selected.

Option in field "White balance"	Additional Input field	Additional fields for configuration	NOTES
<b>Basic auto</b>	<b>RGB-weighted white balance</b>	<b>R-weight G-weight B-weight</b>	The 3 "-weight" fields appear only when the option in the field " <b>RGB-weighted white balance</b> " is <b>On</b> .
<b>Standard auto</b>	<b>RGB-weighted white balance</b>	<b>R-weight G-weight B-weight</b>	
<b>Sodium lamp auto</b>	<b>RGB-weighted white balance</b>	<b>R-weight G-weight B-weight</b>	
<b>Dominant color auto</b>	<b>RGB-weighted white balance</b>	<b>R-weight G-weight B-weight</b>	
<b>Manual</b>		<b>R-gain G-gain B-gain</b>	

### RGB-weighted white balance

In an auto mode, **RGB-weighted white balance** can be switched On or Off. When On, additional fine tuning of the automatic color reproduction can be made with the R, G and B weight sliders.

#### R-weight

When White balance is in an auto mode, and **RGB-weight white balance** is On, this field appears. Adjust the slide for red-gain weight (from -5-0 to +50, with 0 as the default). Reducing red introduces more cyan.

#### G-weight

When White balance is in an auto mode, and **RGB-weight white balance** is On, this field appears. Adjust the slide for green-gain weight (from -5-0 to +50, with 0 as the default). Reducing green introduces more magenta.

#### B-weight

When White balance is in an auto mode, and **RGB-weight white balance** is On, this field appears. Adjust the slide for blue-gain weight (from -5-0 to +50, with 0 as the default). Reducing blue introduces more yellow.

#### R-gain

In **Manual RGB** white balance mode, adjust the red gain slider to offset the factory white point alignment (reducing red introduces more cyan).

#### G-gain

In **Manual RGB** white balance mode, adjust the green gain slider to offset the factory white point alignment (reducing green introduces more magenta).

#### B-gain

In **Manual RGB** white balance mode, adjust the blue gain slider to offset the factory white point alignment (reducing blue introduces more yellow).

## 7.2.2

### Picture Settings

#### Color

##### White Balance

Adjusts the color settings to maintain the quality of the white areas of the image.

- **ATW**: allows the camera to adjust color reproduction continuously.
- **Indoor**: white balance tracking for indoor use.
- **Outdoor**: white balance tracking for outdoor use.
- **AWB hold**: places the ATW on hold and saves the color settings.
- **Extended ATW** (default): allows the camera to adjust constantly for optimal color reproduction.
- **Manual**: Red and Blue gain can be set manually to a desired position.

##### Red Gain

The red gain adjustment offsets the factory white point alignment (reducing red introduces more cyan).

##### Blue Gain

The blue gain adjustment offsets the factory white point alignment (reducing blue introduces more yellow). It is only necessary to change the white point offset for special scene conditions.

Note: The fields **Sodium red level** and **Sodium blue level** appear only when the value in the field **White balance** is “Sodium lamp auto” or “Sodium lamp.”

**Saturation**

Select the percentage of light or color in the video image. The range of options is from 60% to 200%; the default is 100%.

**Color hue**

Select the degree of color in the video image. The range of options is from -14° to 14°; the default is 0°.

**Exposure and gain control****Gain control**

Adjusts the automatic gain control (AGC).

- **AGC** (default): Automatically adjusts the gain to the lowest possible value needed to maintain a good picture.
- **Fixed**: no enhancement. This setting disables the Max. Gain Level option.

**Fixed gain**

Select the desired number for **Fixed gain** from the drop-down box.

**Maximum gain level**

Select the appropriate **Maximum gain level** (for example, **Low**, **Medium** or **High**) with the slider.

**AE-response speed**

Select the speed of the response of auto exposure. Options are Super slow, Slow, Medium (default), Fast.

**Shutter Mode**

- **Fixed**: The shutter mode is fixed to a selectable shutter speed.
- **Automatic exposure**: increases camera sensitivity by increasing the integration time on the camera. This is accomplished by integrating the signal from a number of consecutive video frames to reduce signal noise.  
If you select this option, the camera disables **Shutter** automatically.

**Shutter**

Adjusts the electronic shutter speed (AES). Controls the time period for which light is gathered by the collecting device. The default setting is 1x (60 Hz: 1/30, 50 Hz: 1/25)

**Maximum automatic exposure**

Use this field to limit the integration time when Frame Integration is active. The range of options is from 1/4 to 1/30 (default).

**Default shutter limit**

The camera tries to hold this shutter value as long as sufficient ambient light is available in the scene.

The range of options is from **1/60** to **1/10000**. The default value is **1/120** for all modes except **Motion** (default **1/500**).

**Backlight compensation**

The function will ignore small areas of high illumination directly into the camera. The function increases the brightness of the overall screen to make sure that subjects and the larger portion of the scene remain bright.

Select **Off** to stop **Backlight compensation**. (Default)

Select **On** to start **Backlight compensation**.

**Note:** You cannot use **High dynamic range** and **Backlight compensation** at the same time. (When **High dynamic range** is On, **Backlight compensation** is Off.)

✘ **Backlight compensation** does not work in **Fixed shutter** mode.

## Day/night

### Night mode

Selects night mode (B/W) to enhance lighting in low light scenes. Select from the following options:

- **Monochrome:** Forces the camera to stay in Night Mode and transmit monochrome images.
- **Color:** The camera does not switch to Night Mode regardless of ambient light conditions.
- **Auto (default):** The camera switches out of Night Mode after the ambient light level reaches a pre-defined threshold.

### Night mode threshold

Adjusts the level of light at which the camera automatically switches out of night mode (B/W) operation. Select a value between 10 and 55 (in increments of 5; default 40). The lower the value, the earlier the camera will switch to color mode.

### Night mode priority

Select the option to which the camera should give priority while in night mode:

- Motion
- Color (default)

### Night mode shutter

Controls the time period for which light is gathered by the collecting device while in night mode. Values are  $\frac{1}{4}$ ,  $\frac{1}{8}$ ,  $\frac{1}{15}$ , and  $\frac{1}{30}$ ; the default is  $\frac{1}{15}$ .

## 7.2.3

### Enhance

All settings on this page except for Intelligent Noise Reduction are scene-mode specific. This means that sharpness/noise suppression/HDR can be adjusted on each scene mode.

#### High dynamic range

The **High dynamic range** mode uses an electronic shutter to capture multiple images with different exposure times and to reproduce a high-contrast frame. The output frame combines the bright area captured by the high-speed shutter image and the dark area captured by the low-speed shutter image. The result is that you can view details in both the bright areas (highlights) and the dark areas (shadows) of a scene at the same time.

Select the appropriate option:

- **Off** - stops **High dynamic range**, and enables features such as fixed shutter and BLC.
- **HDR X - Motion optimized** - This mode optimizes focus on objects in fast motion in the scene. The camera has improved dynamic range compared to “Off” mode, but without HDR blending artifacts.
- **HDR X - Optimized DR** - In this mode, the camera optimizes high dynamic range scenes.
- **HDR X - Extreme DR** - This mode gives the highest dynamic range, which can give more visibility, but could possibly cause visual noise or artifacts.

#### Backlight compensation

- Select **Off** to switch off backlight compensation.
- Select **On** to capture details in high-contrast and extremely bright-dark conditions.
- Select Intelligent Auto Exposure to capture object detail in scenes with people moving in front of a bright background.

**Note:** You cannot use **High dynamic range** and **Backlight compensation** at the same time. (When **High dynamic range** is On, **Backlight compensation** is Off.)

✘ **High dynamic range** does not work in **Fixed shutter** mode.

#### Contrast enhancement

Select **On** to increase the contrast in low contrast conditions.

### Intelligent Defog

With the Intelligent Defog mode feature, visibility can be improved significantly when viewing foggy or other low-contrast scenes.

Select **Auto** to activate the Intelligent Defog feature automatically as needed.

Select **Off** to disable the feature.

Select **Extreme** to activate the feature for viewing images of very low contrast.

Select the amount of intensity for the defog feature.

**Note:** This field appears only when the option in Intelligent Defog is "**On**" or "**Auto**."

### Intelligent Dynamic Noise Reduction

Select **On** to activate intelligent Dynamic Noise Reduction (DNR) which reduces noise based on motion and light levels.

### Sharpness level

This field is active when **Sharpness mode** is set to **Manual**.

Adjust the level of sharpness of the video image (from 1 to 15) using the slider.

Adjustments to the **Sharpness level** appear on the OSD.

### Temporal noise filtering

Adjusts the **Temporal noise filtering** level between -15 and +15.

Adjust the balance between noise reduction in a frame over frame averaging way, at the cost of motion blur. The higher the value the more noise is removed at the cost of more blur in moving parts of the scene to achieve a lower bitrate and vice-versa for lower values.

The optimum for most scenes is value zero.

### Spatial noise filtering

Adjust the **Spatial noise filtering** level between -15 and +15.

Adjust the balance between noise reduction spatially every frame, at the cost of reduction of small details. The higher the value the more noise is reduced at the cost of small details to achieve a lower bitrate and vice versa for lower values.

The optimum for most scenes is value zero.

Note: When **High dynamic range** is set to HDR X - Extreme DR, a second column, **Intelligent Streaming dynamic offset**, shows to the right of the input fields for **Sharpness level**, **Temporal noise filtering**, and **Spatial noise filtering**.

### Intelligent streaming

The sharpness level, **Temporal noise filtering** and **Spatial noise filtering** can be automatically adjusted here, through the encoder, for optimum intelligent streaming results.

### Dynamic sharpness & noise filtering

Enable or disable the automatic adjustment of the encoder.

### Priority encoder stream

Select stream 1, 2 or smart select as the priority stream for the encoder. The smart select automatically selects the optimum stream.

## 7.2.4

### Scene Mode Scheduler

The scene mode scheduler is used to determine which scene mode should be used during the day and which scene mode should be used during the night.

1. Select the mode you wish to use during the day from **Marked range** drop-down box.
2. Select the mode you wish to use during the night from **Unmarked range** drop-down box.
3. Use the two slider buttons to set the **Time ranges**.

## 7.3

### Encoder Profile

For the video signal encoding, you can select a code algorithm and you can change the presets for the profiles.



You can adapt the video data transmission to the operating environment (for example network structure, bandwidth, data load). To this end, the camera simultaneously generates two data streams (Dual Streaming), which compression settings you can select individually, for example one setting for transmissions to the Internet and one for LAN connections.

Pre-programmed profiles are available, each giving priority to different perspectives.

You can change individual parameter values of a profile and you can also change the name.

You can switch between profiles by clicking the appropriate tabs.



#### Caution!

The profiles are rather complex. They include a large number of parameters that interact with one another, so it is generally best to use the default profiles.

Change the profiles only once you are fully familiar with all the configuration options.

**Note:** In the default setting, Stream 1 is transmitted for alarm connections and automatic connections.



#### Notice!

All parameters combine to make up a profile and are dependent on one another. If you enter a setting that is outside the permitted range for a particular parameter, the nearest permitted value will be substituted when the settings are saved.

#### Profile name

Profile number	Default Profile name	Description
Profile 1	HD Image Optimized	For an HD image, the video bit rate and frame quality are adjusted to ensure that the picture quality is the priority.
Profile 2	HD Balanced	For an HD image, the video bit rate and frame quality are adjusted to a median profile for everyday use.
Profile 3	HD Bit Rate Optimized	For an HD image, the video bit rate and frame quality are adjusted to ensure that the bit rate is the priority.
Profile 4	SD Image Optimized	For an SD image, the video bit rate and frame quality are adjusted to ensure that the picture quality is the priority.
Profile 5	SD Balanced	For an SD image, the video bit rate and frame quality are adjusted to a median profile for everyday use.
Profile 6	SD Bit Rate Optimized	For an SD image, the video bit rate and frame quality are adjusted to ensure that the bit rate is the priority.
Profile 7	DSL Optimized	Ideal for encoding on a DSL uplink where bit rate limitations are critical.
Profile 8	3G Optimized	Ideal for encoding on a 3G uplink where bit rate limitations are critical.

If required, enter a new name for the profile.

### Bit rate optimization

The bit rate optimization defines the optimization strength. These must be combined with the appropriate scene mode. The **Bit rate optimization** and **Maximum bit rate** work in a quality-driven mode. The encoder generates a bit rate up to the maximum setting if the scene requires it.

For maximum image quality, apply minimum bit rate reduction (**Maximum quality**). This will also greatly increase the file size. If maximum bit rate reduction is applied, the image will have less quality, but the file size decreases significantly (**Minimum bit rate**).

Select the necessary bit rate optimization setting:

- **Off**: bit rate optimization is disabled
- **Maximum quality**
- **High quality**
- **Medium**
- **Low bit rate**
- **Minimum bit rate**

### Maximum bit rate

This maximum bit rate is not exceeded under any circumstances. Depending on the video quality settings for the I- and P-frames, this fact can result in individual images being skipped. The value entered here must be at least 10% higher than the value entered in the **Target bit rate** field. If the value entered here is too low, it will be adjusted automatically.

### Averaging period

Select the appropriate averaging period as a means of stabilizing the long term bit rate.

### Target bit rate

To optimize use of the bandwidth in the network, limit the data rate for the device. The target data rate should be set according to the desired picture quality for typical scenes with no excessive motion.

For complex images or frequent changes of image content due to frequent movements, this limit can temporarily be exceeded up to the value entered in the **Maximum bit rate** field.

**Note:** You can change the value in this field only if you select a duration in the field **Averaging period**. If you do not select an **Averaging period**, then the field **Target bit rate** is greyed out.

### Frame rate

Set the desired value using the slider.

**Note:** A higher frame rate makes motion sequences smoother but requires more disk space. A lower frame rate, achieved by skipping frames, requires less disk space but makes motion sequences less smooth.

### Video resolution

Select the desired resolution for the video image.

**Note:** The value in this field adjusts the resolution for SD streams only.

### Advanced settings

If necessary, use the expert settings to adapt the I-frame quality and the P-frame quality to specific requirements. The setting is based on the H.264 quantization parameter (QP).

### GOP structure

Select the structure that you require for the group of pictures, depending on whether you place greater priority on having the lowest possible delay (IP frames only) or using as little bandwidth as possible.

Options are IP, IBP, and IBBP.

### **I-frame distance**

Use the slider to set the distance between I-frames to **Auto** or to between **3** and **255**. An entry of 3 means that every third image is an I-frame. The lower the number, the more I-frames are generated.

Note that the values supported depend on the GOP structure setting. For example, only even values are supported with IBP; if you have selected IBBP, only 3 or multiples of 3 are supported.

### **Allow enhanced prediction**

This function allows for multiple references in H.264 and H.265 streams, which can reduce bitrate. Some decoders do not support this feature and therefore can be disabled.

### **Min. P-frame QP**

This parameter allows you to adjust the image quality of the P-frame and to define the lower limit for the quantization of the P-frames, and thus the maximum achievable quality of the P-frames. In the H.264-protocol, the Quantization Parameter (QP) specifies the degree of compression and thus the image quality for every frame. The lower the quantization of the P-frame (QP value), the higher the encoding quality (and thus the best image quality) and the lower the frame refresh rate depending on the settings for the maximum data rate under network settings. A higher quantization value results in low image quality and lower network load. Typical QP values are between 18 and 30.

The basic setting Auto automatically adjusts the quality to the settings for the P-frame video quality.

### **I/P-frame delta QP**

This parameter sets the ratio of the I-frame quantization (QP) to the P-frame quantization (QP). For example, you can set a lower value for I-frames by moving the slide control to a negative value. Thus, the quality of the I-frames relative to the P-frames is improved. The total data load will increase, but only by the portion of I-frames. The basic setting Auto automatically adjusts to the optimum combination of movement and image definition (focus). To obtain the highest quality at the lowest bandwidth, even in the case of increased movement in the picture, configure the quality settings as follows:

1. Observe the coverage area during normal movement in the preview images.
2. Set the value for **Min. P-frame QP** to the highest value at which the image quality still meets your needs.
3. Set the value for **I/P-frame delta QP** to the lowest possible value. This is how to save bandwidth and memory in normal scenes. The image quality is retained even in the case of increased movement since the bandwidth is then filled up to the value that is entered under **Maximum bit rate**.

### **Background delta QP**

Select the appropriate encoding quality level for a background region defined in Encoder Regions. The lower the QP value, the higher the encoding quality.

### **Object delta QP**

Select the appropriate encoding quality level for an object region defined in Encoder Regions. The lower the QP value, the higher the encoding quality.

### **Default**

Click **Default** to return the profile to the factory default values.

## **7.4**

### **Encoder Streams**

Note: If you access this menu while the camera is recording, the following message appears at the top of the page:

Recording is currently active. Therefore, for 'Current profile' the respective stream profile selected for recording is displayed for information.

For each stream, select the appropriate options in the fields that follow.

### Property

Select one of the resolutions from the drop-down menu for each stream.

For **Stream 1**, the options are **2560x1440 (3.7 MP)** and **1536x864 (1.3 MP)**.

If you selected **2560x1440 (3.7 MP)**, the options for **Stream 2** are:

- **Copy Stream 1**
- **1080p (2 MP)**
- **1536x864 (1.3 MP)**
- **720p (1 MP)**
- **SD**
- **D1 4:3 (cropped)**
- **640x480**

If you selected **1536x864 (1.3 MP)**, the option for **Stream 2** is **1536x864 (1.3 MP)**.

### Non-recording profile

Select one of the following profiles for each stream:

Profile number	Default Profile name	Description
Profile 1	HD Image Optimized	For an HD image, the video bit rate and frame quality are adjusted to ensure that the picture quality is the priority.
Profile 2	HD Balanced	For an HD image, the video bit rate and frame quality are adjusted to a median profile for everyday use.
Profile 3	HD Bit Rate Optimized	For an HD image, the video bit rate and frame quality are adjusted to ensure that the bit rate is the priority.
Profile 4	SD Image Optimized	For an SD image, the video bit rate and frame quality are adjusted to ensure that the picture quality is the priority.
Profile 5	SD Balanced	For an SD image, the video bit rate and frame quality are adjusted to a median profile for everyday use.
Profile 6	SD Bit Rate Optimized	For an SD image, the video bit rate and frame quality are adjusted to ensure that the bit rate is the priority.
Profile 7	DSL Optimized	Ideal for encoding on a DSL uplink where bit rate limitations are critical.
Profile 8	3G Optimized	Ideal for encoding on a 3G uplink where bit rate limitations are critical.

**Note:** Non-recording profiles (streams) are I-frame only.

**Note:** Each stream can have its own independent profile which does not need to be shared with other streams.

### Active profile

Each stream shows its active profile. When you click the name, the **Encoder Profile (stream number), profile (number)** window appears. Refer to the chapter *Encoder Profile, page 32* for details.

#### JPEG stream

Set the parameters for the M-JPEG stream.

- Select the **Resolution**.
- Select the **Max. frame rate** in images per second (ips).
- The **Picture quality** slider allows adjustment of the M-JPEG image quality from **Low** to **High**.

#### Note:

The M-JPEG frame rate can vary depending on system loading.

#### Video resolution

Select the desired resolution for the video image.

**Note:** Each stream can have its full resolution.

#### Frame rate

The **Frame rate** slider determines the interval at which images are encoded and transmitted. This can be particularly advantageous with low bandwidths. The frame rate is displayed next to the slider.

Click **Test** to see when and if a specific stream will drop frames.

## 7.5 Encoder Statistics

#### Stream

Identifies the current stream (1, 2, or JPEG).

#### Zoom

Identifies the current zoom factor of the camera (1x, 2x, 4x, or 8x).

#### Averaging period

Select the appropriate averaging period as a means of stabilizing the long term bit rate.

## 7.6 Lens Settings

#### Focus

##### Autofocus

Continuously adjusts the lens automatically to the correct focus for the sharpest picture.

- **One Push** (default; commonly called “Spot Focus”): activates the Auto Focus feature after the camera stops moving. Once focused, Auto Focus is inactive until the camera is moved again.
- Auto Focus: Auto Focus is always active.
- Manual: Auto Focus is inactive.

##### Focus speed

Use the slider (from 1 to 8) to control how fast the Auto focus will readjust when the focus becomes blurred.

##### IR focus correction

Optimizes the focus for IR lighting. Options are: On, Off (default).

##### Day near limit [m]

Select the distance (in meters), from 0.1 to 20 m, for the minimum distance of the zoom focus during the day.

**Night near limit [m]**

Select the distance (in meters), from 0.1 to 20 m, for the minimum distance of the zoom focus during the night.

**Auto iris**

Automatically adjusts the lens to allow the correct illumination of the camera sensor. This type of lens is recommended for use where there are low light or changing light conditions.

- **Constant** (default): camera constantly adjusts to varying light conditions (default).  
If you select this option, the camera makes the following changes automatically:
  - **Gain Control**: switches to AGC.
  - **Shutter Speed**: switches to default.
- **Manual**: camera must be manually adjusted to compensate for varying light conditions.

**Auto iris level**

Increases or decreases brightness according to the amount of light. Type a value between 1 and 15.

**Zoom****Maximum zoom speed**

Controls the zoom speed.

**Zoom limit**

Select the appropriate limit for zooming the camera: 20x, 30x.

**Digital zoom**

Digital zoom is a method of decreasing (narrowing) the apparent angle of view of a digital video image. It is accomplished electronically, without any adjustment of the camera's optics, and no optical resolution is gained in the process.

Select **On** to enable this feature.

Select **Off** to disable this feature.

## 7.7

### PTZ Settings

**Auto pan speed**

Continuously pans the camera at a speed between right and left limit settings. Type a value between 1 and 60 (expressed in degrees), inclusive. The default setting is 30.

**Inactivity**

Selects the time period the dome must be not controlled until the inactivity event will be executed.

- **Off** (default): camera remains on a current scene indefinitely.
- **Pre-position 1**: camera returns to **Pre-position 1**.
- **Previous AUX**: camera returns to the previous AUX activity.

**Inactivity period**

Determines the behavior of the camera when the control for the camera is inactive. Select a time period from the pull-down list (3 s - 24 h). The default setting is 2 minutes.

**Number of sectors**

Select the appropriate number of sectors (for example, 4, 6, 12, or 16).

**Note:** The number that you select in this field determines the number of sectors that appear in the **Sectors** page (below).

**Auto pivot**

The Auto pivot tilts the camera through the vertical position as the camera is rotated to maintain the correct orientation of the image. Set the Auto Pivot to On (default) to automatically rotate the camera 180° when following a subject traveling directly beneath the camera. To disable this feature, click Off.

**Freeze frame**

Select On to freeze the image while the camera moves to a predetermined scene position.

**Azimuth**

Select On to display azimuth/elevation readings.

Select Off to hide azimuth/elevation readings.

**Maximum pan speed [%]**

Select the maximum pan speed (in percent). Settings range from 1 to 100. The default is 100.

**Maximum tilt speed [%]**

Select the maximum tilt speed (in percent). Settings range from 1 to 100. The default is 100.

**Tracking zoom-out limit [%]**

This parameter defines the zoom ratio percentage to which the camera zooms out after Tracking idle time [s] stops tracking, or if Intelligent Tracking loses visibility of an object being tracked. This allows the camera to re-acquire the target in a new, wider FoV. Settings range from 0 to 100. The default is 50.

**Tracking idle time [s]**

This parameter allows the camera to stop tracking motion of certain objects, such as a tree or a flag swaying in the wind, in a confined area after the specified number of seconds. Settings range from 5 to 120. The default is 30.

**Auto pan left limit**

Sets the left Auto Pan limit of the camera. Use the preview window to move the camera to the left pan limit and click the button. The camera will not move past this limit when in Auto Pan Between Limits mode (AUX 2 ON).

**Auto pan right limit**

Sets the right Auto Pan limit of the camera. Use the preview window to move the camera to the right pan limit and click the button. The camera will not move past this limit when in Auto Pan Between Limits mode (AUX 2 ON).

**Tilt up limit**

Sets the upper tilt limit of the camera. Use the preview window to move the camera to the tilt limit and click the button.

**Tour A / Tour B**

Starts and stops the recording of a recorded (guard) tour.

The camera can make up to two (2) recorded tours. A recorded tour saves all manual camera movements made during the recording, including its rate of pan, tilt and zoom speeds, and other lens setting changes. The tour does not capture camera video during the recording of the tour.

**Note 1:** You can save a total of 15 minutes of recorded actions between the two tours.

To record a tour:

1. Click the Start Recording button. The system prompts you to overwrite the existing tour.
2. Click Yes to overwrite the existing tour movements.
3. Click the View Control link, under the image cameo, to access the directional and zoom controls.
4. Use the View Control dialog box to make the necessary camera movements.

5. Click the Stop Recording button to save all actions.

**Note: Tour B** is now intended for use with the 'IVA while moving' functions.

You must first calibrate the camera to North before the camera displays accurate compass headings. The camera uses this calibration, usually set to magnetic North, as the zero degree pan position and as the North compass heading. The camera then displays the compass heading based on the number of degrees from the North calibration point.

To set the North calibration point:

1. Determine the North compass heading, then move the camera to that position.
2. Select the radio button **On** for the parameter **Compass**.
3. Click the button next to **North point** to set the calibration point.

#### North point

- Click the **Set** button to overwrite the existing **North point**. A dialog box appears with the message, “Overwrite **North point**?” To confirm, click **OK**. To cancel, click **Cancel**.
- Click the **Clear** button to reset the **North point** to factory defaults. A dialog box appears with the message, “Reset **North point** to factory defaults?” To confirm, click **OK**. To cancel, click **Cancel**.

#### Alternative home position

Click **Set** to set the alternative home position for the camera.

Click **Clear** to clear the alternative home position.

## 7.8

### Pre-positions and Tours

The camera can store up to 256 preset scenes. You can define the individual scenes that comprise a **Pre-position Tour**.

You define individual pre-position scenes, then use these scenes to define the **Pre-position Tour**. The tour starts from the lowest scene number in the tour and progresses sequentially to the highest scene number in the tour. The tour displays each scene for a specified dwell time before advancing to the next scene.

By default, all scenes are part of the **Pre-position Tour** unless removed.

#### To define a Pre-position Tour:

1. Create the individual pre-positions.
  - By default, all scenes in the list **Pre-positions** are in the **Pre-position Tour**.
2. To remove a pre-position from the tour, select the pre-position in the list and uncheck the box **Include in standard tour (marked with \*)**.
3. Select a dwell time from the drop-down list **Standard pre-position tour**.
4. To start the **Pre-position Tour**:
  - Return to the **Live** page.
  - Click **AUX Control**.
  - Type **8** in the input box and click **AUX on**.
5. To stop the tour, type **8** and click **AUX off**.

#### To define a Custom tour

1. Create the individual pre-positions.
2. To add a pre-position into the custom tour, select the pre-position from the general list and click the triangle button to copy it to the custom tour list.
3. Adjust the custom tour sequence by moving preposition up or down.
4. Select a dwell time from the drop-down list **Custom tour**.



5. To start the **Custom tour**:  
Return to the **Live** page.  
Select **Special Functions**.  
Click **AUX Control**.  
Type 7 in the input box and click **AUX on**.
6. To stop the tour, type 7 and click **AUX off**.

**Notice!**

Refer to the document “AUTODOME\_OperationGuidelines\_2014.pdf” for guidelines for operating your camera using Guard Tours and Preset Tours. To access the document, go to [www.boschsecurity.com](http://www.boschsecurity.com), navigate to the product page for your camera, and then locate the document in the Documents tab.

**Sequence settings****Include in standard tour (marked with \*)**

Select this checkbox to include the pre-position in the standard tour.

**Upload**

Click the button to upload the tour configuration to the camera.

**Dwell times****Standard pre-position tour**

Select the dwell time in seconds or minutes for the **Standard pre-position tour**.

**Custom pre-position tour**

Select the dwell time in seconds or minutes for the **Custom pre-position tour**.

## 7.9

### Pre-position settings

**Pre-position**

Select the number of the pre-position for which to save specific settings.

**Name**

Change the name of the pre-position if needed. Click **Set** to save the new name.

**Automatic exposure**

Select the automatic exposure mode. Options are Full-screen or Defined

**Full-screen (Default)**

The camera computes the lighting condition of the entire scene. Then the camera determines the optimum level of iris, gain, and shutter speed.

**Defined**

Move and adjust the size of the green box to cover an interesting area.

The camera computes the lighting condition to the center spot of the specified area. Then the camera determines the optimum level of iris, gain, and shutter speed to get an image.

**Note:** the size shape of the specified area does not matter.

**Day near limit [m]**

Select the distance (in meters), from 0.1 to 20 m, for the minimum distance of the zoom focus during the day.

**Night near limit [m]**

Select the distance (in meters), from 0.1 to 20 m, for the minimum distance of the zoom focus during the night.

**7.10****Sectors****To define a title for sectors:**

1. Place the cursor in the input box to the right of the sector number.
2. Type a title for the sector, up to 20 characters long.
3. To blank the sector, click the check box to the right of the sector title.

**7.11****Miscellaneous****Fast address**

This parameter allows the appropriate camera to be operated via the numerical address in the control system. Enter a number between 0000 and 9999, inclusive, to identify the camera.

**7.12****Audio****Audio**

You can set the gain of the audio signals to suit your specific requirements. The live video image is shown in the window to help you check the audio source. Your changes are effective immediately.

If you connect via Web browser, you must activate the audio transmission on the '**Live**' **functions** page. For other connections, the transmission depends on the audio settings of the respective system.

The audio signals are sent in a separate data stream parallel to the video data, and so increase the network load. The audio data is encoded according to the selected format and requires additional bandwidth. If you do not want any audio data to be transmitted, select **Off**.

**Input volume**

Set the input volume using the slide. Values range from 0 to 119.

**Line Out**

Set the line output gain using the slider. Values range from 0 to 115.

**Recording format**

Select a format for audio recording. The default value is **AAC 48 kbps**. You can select **AAC 80 kbps**, G.711 or L16 depending on the required audio quality or sampling rate.

AAC audio technology is licensed by Fraunhofer IIS.

(<http://www.iis.fraunhofer.de/amm/>)

**7.13****Pixel Counter**

The number of horizontal and vertical pixels covered by the highlighted area is displayed below the picture. With these values you can check whether the requirements for specific functions, for example, identification tasks, are fulfilled.

1. Click **Freeze** to freeze the camera image if the object that you want to measure is moving.
2. To reposition a zone, place the cursor over the zone, hold down the mouse button and drag into position.
3. To change the shape of a zone, place the cursor over the edge of the zone, hold down the mouse button and drag the edge of the zone to the required position.

## 8 Recording

### 8.1 Introduction to recording

Images can be recorded to an appropriately configured iSCSI system or, for devices with an SD slot, locally to an SD card.

SD cards are the ideal solution for shorter storage times and temporary recordings. They can be used for local alarm recording or to improve the overall reliability of video recording. For long-term authoritative images use an appropriately sized iSCSI system.

Two recording tracks are available (**Recording 1** and **Recording 2**). The encoder streams and profiles can be selected for each of these tracks for both standard and alarm recordings. Ten recording profiles are available where these recording tracks can be defined differently. These profiles are then used for building schedules.

A Video Recording Manager (VRM) can control all recording when accessing an iSCSI system. The VRM is an external program for configuring recording tasks for video servers.

### 8.2 Storage Management

#### 8.2.1 Device manager

An external Video Recording Manager (VRM) system for the unit is configured via the Configuration Manager. The **Managed by Video Recording Manager software** box is only an indicator; it cannot be changed here.

If the **Managed by Video Recording Manager software** box is checked, you are not able to configure any further recording settings on this page.

#### 8.2.2 Recording media

Select a media tab to connect to the available storage media.

##### iSCSI Media

To use an **iSCSI system** as the storage medium, a connection to the desired iSCSI system is required to set the configuration parameters.

The storage system selected must be available on the network and completely set up. It must have an IP address and be divided into logical drives (LUNs).

1. Enter the IP address of the required iSCSI destination in the **iSCSI IP address** field.
2. If the iSCSI destination is password protected, enter the password into the **Password** field.
3. Click **Read**.
  - The connection to the IP address is established.

The **Storage overview** field displays the logical drives.

##### Local Media

An SD card inserted in the camera can be used for local recording.

- To use the SD card for Automatic Network Replenishment (ANR), select the check box.
- If the SD card is password-protected, enter the password into the **Password** field.

The **Storage overview** field displays the local media.

**Note:** The recording performance of the SD card depends on the speed (class) and the performance of the SD card. Bosch recommends an SD card of Class 6 or higher.

**Note:** For more information about Automatic Network Replenishment (ANR), refer to the White Paper “ANR 2.0 Automatic Network Replenishment (ANR),” available on the product page for your camera. Access the product page on the online product catalog through the appropriate link from <https://www.boschsecurity.com/xc/en/product-catalog/>.

### 8.2.3 Activating and configuring storage media

Available media or iSCSI drives must be transferred to the **Managed storage media** list, activated, and configured for storage.

**Note:**

An iSCSI target storage device can only be associated with one user. If a target is being used by another user, ensure that the current user no longer needs the target before decoupling that user.

1. In the **Storage overview** section, double-click a storage medium, an iSCSI LUN or one of the other available drives.
  - The medium is added as a target in the **Managed storage media** list.
  - Newly added media is shown as **Not active** in the **Status** column.
2. Click **Set** to activate all media in the **Managed storage media** list.
  - The **Status** column shows all media as **Online**.
3. Check the box in the **Rec. 1** or **Rec. 2** column to specify the recording tracks to be recorded on the target selected.

### 8.2.4 Formatting storage media

All recordings on a storage medium can be deleted at any time. Check the recordings before deleting and back-up important sequences on the computer's hard drive.

1. Click a storage medium in the **Managed storage media** list to select it.
2. Click **Edit** below the list.
3. Click **Format** in the new window to delete all recordings in the storage medium.
4. Click **OK** to close the window.

### 8.2.5 Deactivating storage media

A storage medium in the **Managed storage media** list can be deactivated. It is then no longer used for recordings.

1. Click a storage medium in the **Managed storage media** list to select it.
2. Click **Remove** below the list. The storage medium is deactivated and removed from the list.

## 8.3 Recording Profiles

A recording profile contains the characteristics of the tracks that are used for recording. These characteristics can be defined for ten different profiles. The profiles can then be assigned to days or times of day on the **Recording Scheduler** page.

Each profile is color-coded. The names of the profiles can be changed on the **Recording Scheduler** page.

To configure a profile, click its tab to open its settings page.

- To copy the currently visible settings to other profiles, click **Copy Settings**. A window opens to select the target profiles for the copied settings.
- If you change a profile's settings, click **Set** to save.
- If necessary, click **Default** to return all settings to their factory defaults.

### Stream profile settings

Select the encoder profile setting that is to be used with stream 1 and 2 when recording. This selection is independent of the selection for live stream transmission. (The properties of the encoder profiles are defined on the **Encoder Profile** page.)

### Pre-position

Select the appropriate pre-position to record. Options are **Tour A**, **Tour B**, **Custom Tour**, and configured pre-positions.

### Settings for selected recordings

#### Recording includes

You can specify whether, in addition to video data and metadata (for example alarms, VCA data and serial data) should also be recorded. Including metadata could make subsequent searches of recordings easier but it requires additional memory capacity.



#### Caution!

Without metadata, it is not possible to include video content analysis in recordings.

Select what is to be included in the recordings:

- **Audio:** If audio is not enabled, **Off** is shown. Click on **Off** and the page is redirected to the **Audio** section.
- **Metadata.**

#### Standard recording

Select the mode for standard recordings:

- **Continuous:** the recording proceeds continuously. If the maximum recording capacity is reached, older recordings are overwritten automatically.
- **Pre-alarm:** recording takes place in the pre-alarm time, during the alarm and during the post-alarm time only.
- **Off:** no automatic recording takes place.

#### Stream

Select the stream to be used for standard recordings:

- **Stream 1**
- **Stream 2**
- **I-frames only**

#### Alarm recording

Select a period for the **Pre-alarm time** from the list box.

Select a period for the **Post-alarm time** from the list box.

#### Alarm stream

Select the stream to be used for alarm recordings:

- **Stream 1**
- **Stream 2**
- **I-frames only**

Check the **encoding interval and bit rates from profile:** box and select an encoder profile to set the associated encoding interval for alarm recording.

Check the **Export to account** box to send standard H.264 or H.265 files to the target whose address is displayed.

If the target has not yet been defined, click **Configure accounts** to jump to the **Accounts** page where the server information can be entered.

#### Alarm triggers \*

Select the alarm type that is to trigger an alarm recording:

- **Alarm input**
- **Analysis alarm**
- **Video loss**

Select the **Virtual alarm** sensors that are to trigger a recording, via RCP+ commands or alarm scripts, for example.

## 8.4 Maximum Retention Time

Recordings are overwritten when the retention time entered here has expired.

- ▶ Enter the required retention time in days for each recording track.

Make sure that the retention time does not exceed the available recording capacity.

## 8.5 Recording Scheduler

The recording scheduler allows you to link the created recording profiles with the days and times at which the camera's images are to be recorded in the event of an alarm.

You can link any number of 15-minute intervals with the recording profiles for each day of the week. Moving the mouse cursor over the table displays the time below it. This aids orientation. In addition to the normal weekdays, you can define holidays that are not in the standard weekly schedule on which recordings are to apply. This allows you to apply a schedule for Sundays to other days with dates that fall on varying weekdays.

#### Weekdays

Assign as many time periods (in 15-minute intervals) as needed for any day of the week. Move the mouse cursor over the table - the time is displayed.

1. Click the profile to be assigned in the **Time periods** box.
2. Click a field in the table and, while holding down the left mouse button, drag the cursor across all of the fields to be assigned to the selected profile.
3. Click the **No recordings** profile in the **Time periods** box to deselect the intervals.
4. Click **Select All** to select all of the intervals to be assigned to the selected profile.
5. Click **Clear All** to deselect all of the intervals.
6. When finished, click **Set** to save the settings to the device.

#### Holidays

You can define holidays that are not in the standard weekly schedule on which recordings are to apply. This allows you to apply a schedule for Sundays to other days with dates that fall on varying weekdays.

1. Click the **Holidays** tab. Any days that have already been selected will be shown in the table.
2. Click the **Add** button. A new window will open.
3. Select the desired date from the calendar. You can select several consecutive calendar days by holding down the mouse button. These will later be displayed as a single entry in the table.
4. Click **OK** to accept the selection. The window will close.
5. Assign the individual holidays to the recording profiles, as described above.

#### Deleting Holidays

You can delete holidays you have defined yourself at any time.

1. Click the **Delete** button. A new window will open.

2. Click the date you wish to delete.
3. Click **OK**. The item will be deleted from the table and the window will close.
4. The process must be repeated for deleting additional days.

#### **Time periods**

You can change the names of the recording profiles.

1. Click a profile and then the **Rename** button.
2. Enter your chosen name and then click the **Rename** button again.

#### **Activating the Recording**

After completing configuration you must activate the recording scheduler and start the recording. Once recording is underway, the **Recording Profiles** and **Recording Scheduler** pages are deactivated and the configuration cannot be modified.

You can stop the recording activity at any time and modify the settings.

1. Click the **Start** button to activate the recording scheduler.
2. Click the **Stop** button to deactivate the recording scheduler. Running recordings are interrupted and the configuration can be changed.

#### **Recording status**

The graphic indicates the recording activity of the camera. You will see an animated graphic while recording is taking place.

## **8.6 Recording Status**

Details of the recording status are displayed here for information. These settings cannot be changed.

## **8.7 Recording Statistics**

#### **Recording**

Identifies the current recording profile (1 or 2).

#### **Zoom**

Identifies the current zoom factor of the camera (1x, 2x, 4x, or 8x).

#### **Averaging period**

Select the appropriate averaging period as a means of stabilizing the long term bit rate.

## **8.8 Image Posting**

#### **JPEG**

##### **Image size**

Select the size of the JPEG images that are to be sent from the camera. JPEG resolution corresponds to the highest setting from the two data streams.

Options are:

- 256 x 144
- 512 x 288
- 768 x 432
- 1280 x 720
- 1536 x 864
- 1920 x 1080
- 2560 x 1440
- **Resource based**

The default option is 256 x 144.

##### **File name**

Select how file names are created for the individual images that are transmitted.

- **Overwrite:** The same file name is always used and any existing file will be overwritten by the current file.
- **Increment:** A number from 000 to 255 is added to the file name and automatically incremented by 1. When it reaches 255, it starts again from 000.
- **Date/time suffix:** The date and time are automatically added to the file name. When setting this parameter, make sure that the date and time of the device are always set correctly. For example, the file snap011005\_114530.jpg was stored on October 1, 2005 at 11:45 and 30 seconds.

**VCA overlays**

To include VCA overlays in the email, select this check box.

**Posting interval**

Enter the interval in seconds at which the images are sent to an FTP server. Enter zero for no images to be sent.

The following field may or may not appear, depending on your camera:

**Target**

Select the target account for JPEG posting.

**Notice!**

You must configure an account in order to have functionality for **Image Posting**. Click on **Configure accounts** to do so.

---



## 9

## Alarm

### 9.1

### Alarm Connections

You can select how the camera responds to an alarm. In the event of an alarm, the unit can automatically connect to a pre-defined IP address. You can enter up to ten IP addresses to which the camera will connect in sequence in the event of an alarm, until a connection is made.

#### Connect on alarm

Select **On** so that the camera automatically connects to a predefined IP address in the event of an alarm.

By setting **Follows input 1\***, the unit maintains the connection that has been automatically established for as long as an alarm exists on alarm input 1.



#### Notice!

In the default setting, Stream 2 is transmitted for alarm connections. Consider this when assigning the profile (see Encoder Profile).

#### Auto-connect

Select the **On** option to automatically re-establish a connection to one of the previously specified IP addresses after each reboot, after a connection breakdown or after a network failure.



#### Notice!

In the default setting, Stream 2 is transmitted for automatic connections. Bear this fact in mind when assigning the profile (see Encoder Profile).

#### Number of destination IP address

Specify the numbers of the IP addresses to be contacted in the event of an alarm. The unit contacts the remote stations one after the other in the numbered sequence until a connection is made.

#### Destination IP address

For each number, enter the corresponding IP address for the desired remote station.

#### Destination password

If the remote station is password protected, enter the password here.

Only ten passwords can be defined here. Define a general password if more than ten connections are required. The unit connects to all remote stations protected by the same general password. To define a general password:

1. Select 10 in the **Number of destination IP address** list box.
2. Enter 0.0.0.0 in the **Destination IP address** field.
3. Enter the password in the **Destination password** field.
4. Set the user password of all the remote stations to be accessed using this password.

Setting destination 10 to the IP-address 0.0.0.0 overrides its function as the tenth address to try.

#### Video transmission

If the unit is operated behind a firewall, select **TCP (HTTP port)** as the transfer protocol. For use in a local network, select **UDP**.

**Caution!**

Please note that in some circumstances, a larger bandwidth must be available on the network for additional video images in the event of an alarm, in case Multicast operation is not possible. To enable Multicast operation, select the **UDP** option for the **Video transmission** parameter here and on Network Access.

**Stream**

Select the number of the stream from the drop-down list.

**Remote port**

Depending on the network configuration, select a browser port here. The ports for HTTPS connections will be available only if the **On** option is selected in the **SSL encryption** parameter.

**Video output**

If you know which unit is being used as the receiver, you can select the analog video output to which the signal should be switched. If the destination unit is unknown, it is advisable to select the **First available** option. In this case, the image is placed on the first free video output. This is an output on which there is no signal. The connected monitor only displays images when an alarm is triggered. If you select a particular video output and a split image is set for this output on the receiver, you can also select from **Decoder** the decoder in the receiver that is to be used to display the alarm image.

**Notice!**

Refer to the destination unit documentation concerning image display options and available video outputs.

**Decoder**

If a split image is set for the selected video output, select a decoder to display the alarm image. The decoder selected determines the position in the split image.

**SSL encryption**

SSL encryption protects data used for establishing a connection, such as the password. By selecting **On**, only encrypted ports are available for the **Remote port** parameter. SSL encryption must be activated and configured on both sides of a connection.

The appropriate certificates must also have been uploaded. (Certificates can be uploaded on the **Maintenance** page.)

Configure and activate encryption for media data (such as video, metadata or audio when available) on the **Encryption** page (encryption is only available if the appropriate license is installed).

**Audio**

Select **On** to activate audio alarms.

**9.2****Video Content Analysis (VCA)**

**Note:** This section of the manual provides an overview of the fields and the options for each field on the page **VCA**. This section is not a complete tutorial of setting up **VCA**. For more information, refer to the separate manual Video Content Analysis (VCA), available on the product page for Intelligent Video Analytics. Access the product page on the online product catalog from <http://www.boschsecurity.com/corporate/product-catalog/index.html>.

**VCA configuration**

Select one of the profiles here to activate it or edit it.

You can rename the profile.

1. To rename the file, click the icon to the right of the list field and enter the new profile name in the field.
2. Click the icon again. The new profile name is saved.

Do not use any special characters, for example **&**, in the name. Special characters are not supported by the system's internal management.

If you select the option Silent VCA, then the system creates metadata to facilitate searches of recordings but no alarm is triggered. You cannot change any parameters for this configuration. If you want to turn off VCA, then select Off.

If necessary, click the button **Default** to return all settings to their default values. A dialog box appears with the message, "**Configuration of the video content analysis (VCA) will be reset to factory defaults. The changes will be lost. Click 'OK' to continue.**" Click **OK** to acknowledge the message, or click **Cancel**.

### Scenario

Scenarios are applications with pre-defined settings that are adapted to specific use cases. All relevant settings, from tasks to metadata, are set automatically by the system.

The following scenarios are available:

- Intrusion (one field)
- Intrusion (two fields)
- People counting
- Traffic incidents
- Traffic wrong way



### Notice!

A camera calibration is required for all scenarios.

Using the scenarios will reset the VCA configuration to the scenario defaults.

All values (**Metadata Generation** and **Tasks**) can be edited after activating the scenario defaults.

Delete tasks that do not fit your use cases.

### Analysis type

Select the appropriate option for Video Content Analysis: MOTION+, Intelligent Video Analytics, or Intelligent Video Analytics Flow.

**Note:** When you select another analysis type, a dialog box appears with the message, "**Changing the analysis type resets motion and tamper parameters.**" Click **OK** to acknowledge the message (and to switch analysis types), or click **Cancel**.

### Alarm status

The alarm status is displayed here for information purposes. This means you can check the effects of your settings immediately.

### Tamper detection

Detect tampering of cameras and video cables by means of various options. Run a series of tests at different times of the day and night to ensure that the video sensor is operating as intended.

**Sensitivity** and **Trigger delay [s]** can only be changed if **Reference check** is selected.

### Reference check

Save a reference image that can be continuously compared with the current video image. If the current video image in the marked areas differs from the reference image, an alarm is triggered. This detects tampering that would otherwise not be detected, for example, if the camera is turned.

1. Click **Reference** to save the currently visible video image as a reference.
2. Click **Add mask** and select the areas in the reference image that are to be ignored. Click **Set** to apply.
3. Check the box **Reference check** to activate the on-going check. The stored reference image is displayed in black and white below the current video image.
4. Select the **Disappearing edges** or **Appearing edges** option to specify the reference check once again.

### Trigger delay [s]

Set delayed alarm triggering here. The alarm is only triggered after a set time interval in seconds has elapsed and then only if the triggering condition still exists. If the original condition has been restored before this time interval elapses, the alarm is not triggered. This avoids false alarms triggered by short-term changes, for example, cleaning activities in the direct field of vision of the camera.

### Global change

You can set how large the global change in the video image must be for an alarm to be triggered. This setting is independent of the sensor fields selected under **Select Area**. Set a high value if fewer sensor fields need to change to trigger an alarm. With a low value, it is necessary for changes to occur simultaneously in a large number of sensor fields to trigger an alarm.

This option allows you to detect, independently of motion alarms, manipulation of the orientation or location of a camera resulting from turning the camera mount bracket, for instance.

### Global change

Activate this function if the global change, as set with the **Global change** slide control, should trigger an alarm.

## 9.3

### Audio Alarm

The camera can create alarms on the basis of audio signals. You can configure signal strengths and frequency ranges in such a way that false alarms, for example due to machine noise or background noise, are avoided.



#### Notice!

First set up normal audio transmission before you configure the audio alarm here (see Audio).

#### Audio alarm

Select **On** if you want the device to generate audio alarms.

Do not use any special characters, for example **&**, in the name. Special characters are not supported by the system's internal management.

#### Signal Ranges

You can exclude particular signal ranges in order to avoid false alarms. For this reason the total signal is divided into 13 tonal ranges (mel scale). Check or uncheck the boxes below the graphic to include or exclude individual ranges.

**Threshold**

Set up the threshold on the basis of the signal visible in the graphic. You can set the threshold using the slide control or, alternately, you can move the white line directly in the graphic using the mouse.

**Sensitivity**

You can use this setting to adapt the sensitivity to the sound environment. You can effectively suppress individual signal peaks. A high value represents a high level of sensitivity.

**9.4****Alarm E-Mail**

As an alternative to automatic connecting, alarm states can also be documented by e-mail. In this way it is possible to notify a recipient who does not have a video receiver. In this case, the camera automatically sends an e-mail to a previously defined e-mail address.

**Send alarm e-mail**

Select **On** if you want the unit to automatically send an alarm e-mail in the event of an alarm.

**Mail server IP address**

Enter the IP address of a mail server that operates on the SMTP standard (Simple Mail Transfer Protocol). Outgoing e-mails are sent to the mail server via the address you entered. Otherwise leave the box blank (**0.0.0.0**).

**SMTP port**

Select the appropriate SMTP port.

**SMTP user name**

Enter a registered user name for the chosen mailserver here.

**SMTP password**

Enter the required password for the registered user name here.

**Format**

You can select the data format of the alarm message.

- **Standard (with JPEG)** E-mail with attached JPEG image file.
- **SMS** E-mail in SMS format to an e-mail-to-SMS gateway (for example to send an alarm by cellphone) without an image attachment.

**Caution!**

When a cellphone is used as the receiver, make sure to activate the e-mail or SMS function, depending on the format, so that these messages can be received.

You can obtain information on operating your cellphone from your cellphone provider.

**Image size**

Select the size of the JPEG images that are to be sent from the camera.

Options are:

- 256 x 144
- 512 x 288
- 768 x 432
- 1280 x 720
- 1536 x 864
- 1920 x 1080
- 2560 x 1440
- **Resource based**

**Attach JPEG from camera**

Click the checkbox to specify that JPEG images are sent from the camera. An enabled video input is indicated by a check mark.

**VCA overlays**

Select the **VCA overlays** check box, to place the outline of the object that triggered an alarm into the camera image sent as snapshot via e-mail.

**Destination address**

Enter the e-mail address for alarm e-mails here. The maximum address length is 49 characters.

**Sender address**

Enter a unique name for the e-mail sender, for example the location of the device. This will make it easier to identify the origin of the e-mail.

**Note:** The name must include at least two character groups separated by a blank (for example, Parking Garage) in order for the system to generate an email from that name, as in "From Parking Garage". Text with only one group of characters (for example, Lobby) will not generate an email.

**Test e-mail**

You can test the e-mail function by clicking the **Send Now** button. An alarm e-mail is immediately created and sent.

## 9.5

### Alarm Inputs

**Active**

Configure the alarm triggers for the unit.

Select **N.C.** (Normally Closed) if the alarm is to be triggered by opening the contact.

Select **N.O.** (Normally Open) if the alarm is to be triggered by closing the contact.

Select **N.C.S.** (Normally Closed Supervised) if the alarm is to be triggered by opening the contact.

Select **N.O.S.** (Normally Open Supervised) if the alarm is to be triggered by closing the contact.

A supervised alarm transmits both the alarm condition and the tamper condition. Depending on how the alarm is configured, a short or a break in the alarm's circuit can trigger the tamper signal.

(NCS and NOS contacts are only present on some cameras)

**Name**

You can enter a name for each alarm input. If the **Live** functions are configured accordingly, this name is displayed below the icon for the alarm input. You can also use the name in the Forensic Search program function as a filter option for quick search in recordings. Enter a unique and clear name here.

**Caution!**

Do not use any special characters, for example **&**, in the name.

Special characters are not supported by the system's internal management.

**Note:** This name appears in the **Digital I/O** section of the **Live** page.

**Action**

Select a type of action to be performed when an alarm input occurs:

- **None**
- **Monochrome**

This switches the camera to the monochrome mode.

- **Switch mode**  
When this is selected, you can select the **Scene Mode** to be used for the active and inactive period of the alarm.  
(only available on some cameras)

## 9.6 Alarm Outputs

### Idle state

Select **Open** if you want the relay to operate as an NO contact, or select **Closed** if the relay is to operate as an NC contact.

### Operating mode

Select an operating mode for the relay.

For example, if you want an alarm-activated lamp to stay on after the alarm ends, select **Bistable**. If you wish an alarm-activated siren to sound for ten seconds, for example, select **10 s**.

### Output name

Enter a name for the alarm output.

This name appears on the **Live** page.

**Note:** This name appears in the **Digital I/O** section of the **Live** page.

### Toggle

Click the button to test the relay / output connection.

## 9.7 Alarm Task Editor

Editing scripts on this page overwrites all settings and entries on the other alarm pages. This procedure cannot be reversed.

To edit this page, you should have programming knowledge and be familiar with the information in the Alarm Task Script Language document and the English language.

As an alternative to the alarm settings on the various alarm pages, enter the desired alarm functions in script form here. This will overwrite all settings and entries on the other alarm pages.

1. Click **Examples** under the Alarm Task Editor field to see some script examples. A new window opens.
2. Enter new scripts in the Alarm Task Editor field or change existing scripts in line with your requirements.
3. When finished, click **Set** to transmit the scripts to the device. If the transfer was successful, the message **Script successfully parsed.** is displayed over the text field. If it was not successful, an error message is displayed with further information.

## 9.8 Alarm Rules

An alarm rule can define which input(s) activate which output(s). Basically, an alarm rule allows you to customize the camera to respond automatically to different alarm inputs. To configure an alarm rule, specify one input from a physical connection, from a motion detection trigger, or from a connection to the camera's LIVE page. The physical input connection can be activated by dry contact devices such as pressure pads, door contacts, and similar devices.

Next, specify up to two (2) rule outputs, or the camera's response to the input. Outputs include a physical alarm output, an AUX command, or a preposition scene.

Select the appropriate option in the field **Input** (a physical alarm connection):

- **Video analytics/MOTION+:** If you select this option, then an alarm will begin when IVA or motion detection is activated.
- **Connection:** If you select this option, then an alarm will begin when an attempt is made to access the camera's IP address.
- **Time:** If you select this option, then an input field appears to the right. In this field, enter the time for the activation of the alarm in hours and minutes. (The default value is 00:00.)
- **Time range:** If you select this option, then two input fields appear to the right. In these fields, enter the time range for the activation of the alarm in hours and minutes. (The default values are 00:00 and 00:00.)

Select one of the following output commands for both Output 1 and Output 2 settings:

Note: Not all options are available for all cameras.

- **None:** no defined command.
- **Alarm output:** defines an alarm output.
- **AUX on:** defines a standard or custom keyboard ON command.
- **AUX off:** defines a standard or custom keyboard OFF command.
- **Pre-position:** defines a pre-position from shot 1-256. (Note: This option is not available for the input **Time range**.)
- **Monochrome:** triggers the camera to give the output in monochrome mode.
- **Alarm output**



---

Click the checkbox **Enabled** to activate the alarm.  
Click Set to save. The camera's system activates the alarm rules.

## 10 Network

### 10.1 Network Services

This page shows an overview of all available network services. Use the checkbox to activate or deactivate a network service. Click on the settings symbol next to the network service to go to the settings page for this network service.

### 10.2 Network Access

The settings on this page are used to integrate the camera into an existing network.

#### Automatic IPv4 assignment

If the network has a **DHCP** server for the dynamic assignment of IP addresses, select **On** to accept automatically the **DHCP-assigned IP address**.

For certain applications, the **DHCP** server must support the fixed assignment between **IP address** and **MAC address**, and must be set up appropriately so that, once an IP address is assigned, it is retained each time the system is rebooted.

#### Ethernet

The Ethernet options are defined in this section.

#### IP V4 address

##### IP address

Enter the desired IP address for the camera in this field. The IP address must be valid for the network.

##### Subnet mask

Enter the appropriate subnet mask for the selected IP address here.

##### Gateway address

If you want the unit to establish a connection to a remote location in a different subnet, enter the IP address of the gateway here. Otherwise leave the box blank (**0.0.0.0**).

#### IP V6 address

##### IP address

Enter the desired IP address for the camera in this field. The IP address must be valid for the network. A typical IPv6 address may resemble the following example:

2001:db8: :52:1:1

Consult the network administrator for valid IPv6 address construction.

##### Prefix length

A typical IPv6 node address consists of a prefix and an interface identifier (total 128 bits). The prefix is the part of the address where the bits have fixed values or are the bits that define a subnet.

##### Gateway address

If you want the unit to establish a connection to a remote location in a different subnet, enter the IP address of the gateway here. Otherwise leave the box blank (**0.0.0.0**).

#### DNS server address 1 / DNS server address 2

The camera is easier to access if the unit is listed on a DNS server. If you wish, for example, to establish an Internet connection to the camera, it is sufficient to enter the name given to the unit on the DNS server as a URL in the browser. Enter the IP address of the DNS server here. Servers are supported for secure and dynamic DNS.

#### Video transmission

If the unit is operated behind a firewall, select **TCP (HTTP port)** as the transfer protocol. For use in a local network, select **UDP**.

**Notice!**

Multicast operation is only possible with the UDP protocol. The TCP protocol does not support multicast connections. The MTU value in UDP mode is 1,514 bytes.

**UDP encryption**

Enable this option to encrypt the User Datagram Protocol (UDP) connection. UDP with encryption can also be used in multicast networks.

**HTTP browser port**

Select a different HTTP browser port from the list if required. The default HTTP port is 80. If you want to allow only secure connections via HTTPS, you must deactivate the HTTP port. In this case, select **Off**.

**HTTPS browser port**

If you wish to allow browser access on the network via a secure connection, select an HTTPS browser port from the list if necessary. The default HTTPS port is 443. Select the **Off** option to deactivate HTTPS ports; only unsecured connections will now be possible.

The camera uses the TLS 1.0 encryption protocol. You may have to activate this protocol via your browser configuration. You must also activate the protocol for the Java applications (via the Java control panel in the Windows control panel).

**Notice!**

If you want to allow only secure connections with SSL encryption, you must select the **Off** option for each of the parameters **HTTP browser port**, **RCP+ port 1756** and **Telnet support**. This deactivates all unsecured connections. Connections will then only be possible via the HTTPS port.

You can activate and configure encryption of the media data (video and metadata) on the **Encryption** page (see Encryption).

**Minimum TLS version**

Select the version for minimum Transport Layer Security (TLS).

**Allow HTTP basic authentication**

Select **On** if you want to allow HTTP basic authentication. This is a less secure authentication option where passwords are transmitted in clear text. This option should only be used if the network and system are otherwise secured.

**HSTS**

Select this option to use the web security policy HTTP Strict Transport Security (HSTS) to provide secure connections.

**RCP+ port 1756**

To exchange connection data, you can activate the unsecured RCP+ port 1756. If you want connection data to be transmitted only when encrypted, select the **Off** option to deactivate the port.

**Discovery port (0 = Off)**

Enter the number of the port that you want to discover.

To deactivate the port, enter 0.

**Interface mode ETH**

Select the Ethernet link type for the ETH interface.

Options are:

- Auto

- 10 Mbps HD (half duplex)
- 10 Mbps FD (full duplex)
- 100 Mbps HD (half duplex)
- 100 Mbps FD (full duplex)

#### **Network MSS (Byte)**

You can set the maximum segment size for the IP packet's user data. This gives you the option to adjust the size of the data packets to the network environment and to optimize data transmission. Please comply with the MTU value of 1,514 bytes in UDP mode.

#### **Network MTU [Byte]**

Specify a maximum value in bytes for the package size (including IP header) to optimize data transmission.

## 10.3

### **Advanced**

The settings on this page are used to implement advanced settings for the network.

#### **RTSP**

##### **802.1x**

#### **Authentication**

If a RADIUS server is employed in the network for managing access rights, authentication must be activated here to allow communication with the unit. The RADIUS server must also contain the corresponding data.

To configure the unit, you must connect the camera directly to a computer using a network cable. This is because communication via the network is not enabled until the **Identity** and **Password** parameters have been set and successfully authenticated.

#### **Identity**

Enter the name that the RADIUS server is to use for identifying the camera.

#### **Password**

Enter the password that is stored in the RADIUS server.

#### **Password [EAP-MD5]**

Enter the password that is stored in the RADIUS server.

#### **Certificates [EAP-TLS]**

If any certificates are already uploaded at the client level or at the server level, they show here.

Click **Configure**.

#### **TCP metadata input**

##### **TCP port**

The device can receive data from an external TCP sender, for example an ATM or POS device, and store it as metadata. Select the port for TCP communication. Select Off to deactivate the TCP metadata function.

##### **Sender IP address**

Enter the IP address of the TCP metadata sender here.

##### **Syslog**

##### **Server IP address**

Enter the appropriate IP address of the server.

##### **Server port (0 = Off)**

Enter the number of the server port.

**Protocol**

Select the appropriate protocol: **UDP**, **TCP**, or **TLS**.

**LLDP power configuration****Requested for camera**

The value in this field identifies the number of watts requested for the camera.

**Additional Power**

Enter the number of additional watts that you want the camera to use.

**Requested total**

The value in this field is the total number of watts from the fields **Requested for camera** and **Additional Power**.

**Allocated power**

The value in this field is the number of watts of allocated power to the camera.

## 10.4 Network Management

### 10.4.1 UPnP

Select **On** to activate UPnP communication. Select **Off** to deactivate it.

When the Universal Plug-and-Play (UPnP) function is activated, the unit responds to requests from the network and is automatically registered on the requesting computers as a new network device. This function should not be used in large installations due to the large number of registration notifications.

**Note:**

To use the UPnP function on a Windows computer, both the Universal Plug-and-Play Device Host and the SSDP Discovery Service must be activated.

### 10.4.2 Quality of Service

The priority of the different data channels can be set by defining the DiffServ Code Point (DSCP). Enter a number between 0 and 252 as a multiple of four. For alarm video you can set a higher priority than for regular video and you can define a Post Alarm Time over which this priority is maintained.

## 10.5 Network Management

**SNMP**

The camera supports two versions of Simple Network Management Protocol (SNMP) for managing and monitoring network components, and can send SNMP messages (traps) to IP addresses. The unit supports SNMP MIB II in the unified code.

Select either of the options that follow for the **SNMP** parameter:

- **SNMP v1 legacy**
- **SNMP v3**

If you select either of the SNMP version, but do not enter an SNMP host address, the camera does not send messages (traps) automatically, but only replies to SNMP requests.

Select **Off** to deactivate the SNMP function.

**1. SNMP host address / 2. SNMP host address**

If you wish to send SNMP traps automatically, enter the IP addresses of one or two required target units here.

The three (3) subchapters that follow identify the fields that appear depending on the option that you select in the field **SNMP**.

## 10.6 Multicast

The camera can enable multiple receivers to receive the video signal simultaneously. The stream is either duplicated and then distributed to multiple receivers (Multi-unicast), or it is sent as a single stream to the network, where it is simultaneously distributed to multiple receivers in a defined group (Multicast).

Multicast operation requires a multicast-enabled network that uses UDP and the Internet Group Management protocol (IGMP V2). The network must support group IP addresses. Other group management protocols are not supported. The TCP protocol does not support multicast connections.

A special IP address from 225.0.0.0 to 239.255.255.255 (class D address) must be configured for multicast operation in a multicast-enabled network. The multicast address can be the same for multiple streams, however, it is necessary to use a different port in each case.

The settings must be made individually for each stream. Enter a dedicated multicast address and port for each stream. Switch between the streams by clicking the appropriate tabs.

### Enable

Enable simultaneous data reception on receivers that need to activate the multicast function. To do this, check the box and enter the multicast address.

### Multicast Address

Enter a valid multicast address to be operated in multicast mode (duplication of the data stream in the network).

With a 0.0.0.0 setting, the encoder for the stream operates in multi-unicast mode (copying of data stream in device). The camera supports multi-unicast connections for up to five simultaneously connected receivers.

Duplication of data places a heavy demand on the CPU and can lead to impairment of the image quality under certain circumstances.

### Port

Enter the port address for the stream here.

### Streaming

Click the checkbox to activate multicast streaming mode. An activated stream is marked with a check. (Streaming is typically not required for standard multicast operation.)

### Multicast packet TTL

You can enter a value to specify how long the multicast data packets are active on the network. This value must be greater than one if multicast is to be run via a router.

### IGMP version

You can define the multicast IGMP version to comply with the device. Click **Set** to apply the changes.

## 10.7 CloudWatch

### CloudWatch

#### Enable CloudWatch

Select this checkbox to activate Amazon CloudWatch.

Amazon CloudWatch is a monitoring and management service built for developers, system operators, site reliability engineers, and IT managers. It provides you with data and actionable insights to monitor your applications, understand and respond to system-wide performance changes, optimize resource utilization, and get a unified view of operational health.

**Access key ID and Secret access key**

Enter the correct access key ID and secret access key information.

Access keys consist of two parts: an access key ID (for example, AKIAIOSFODNN7EXAMPLE) and a secret access key (for example, wJalrXUtnFEMI/K7MDENG/bPxrRfiCYEXAMPLEKEY).

Like a user name and password, you must use both the access key ID and secret access key together to authenticate your requests. Manage your access keys as securely as you do your user name and password.

**Region**

Enter the region that the camera resides in.

**Stream name**

Enter the stream name assigned to the camera.

**Group**

Enter the group that the camera resides in.

A group is a collection of resources that are all in the same region and that match criteria provided in a query.

Click **Set** to apply the changes.

## 10.8

### IPv4 Filter

Use this setting to configure a filter that allows or blocks network traffic that matches a specified address or protocol.

**IP Address 1 / 2**

Enter the IPv4 address that you want to allow or block

**Mask 1 / 2**

Enter the subnet mask for the appropriate IPv4 address.

# 11

## 11.1

## Service

### Maintenance

#### Update server

The address of the update server appears in the address box.

1. Click **Check** to make a connection to this server.
2. Select the appropriate version for your camera to download the firmware from the server.

#### Firmware

The camera functions and parameters can be updated by uploading new firmware. To do this, the latest firmware package is transferred to the device via the network. The firmware is installed there automatically. Thus, a camera can be serviced and updated remotely without requiring a technician to make changes to the device on site. The latest firmware can be obtained from your customer service center or from the download area.



#### Notice!

Potential loss of data

Bosch recommends that you save all device configurations, including IVA and calibration, on your network before starting a firmware update.



#### Notice!

Before starting a firmware update, make sure to select the correct upload file.

Do not interrupt the firmware installation. Even changing to another page or closing the browser window leads to interruption.

Uploading the wrong files or interrupting the upload can result in the device no longer being addressable, requiring it to be replaced.



#### Caution!

Do not remove power to the unit during a factory default or a firmware update. Wait at least two minutes for the default process to complete. If the unit appears to be "frozen" after two minutes, then reboot the unit. Refer to Troubleshooting for more details.

#### Progress

The progress bar displays the progress of the firmware upload.

**Note:** Once the progress bar reaches 100%, a reset page may appear. If this page appears, allow the reset page to complete its action.

#### Upload history

Click **Show** to view the firmware upload history.

#### Configuration

Click **Browse...** to navigate to the required firmware file (\*.fw).

**Note:** Ensure that the file to be loaded comes from the same unit type as the unit that you want to configure.

Click **Upload** to begin transferring the file to the unit. Click OK to the warning message to continue the firmware upload, or Cancel to stop the upload.

Click **Download** to save the camera settings to a file to upload to the same camera or to a similar camera in the future.

#### Maintenance log

You can download an internal maintenance log from the unit to send it to Customer Service for support purposes. Click **Download** and select a storage location for the file.



## 11.2 Licenses

This window is for the activation of additional functions by entering activation codes. An overview of installed licenses is shown. The installation code of the unit is also displayed here.

## 11.3 Certificates

### Add a certificate/file to the file list

Click **Add**.

In the Add certificate window choose either:

- **Upload certificate** to select a file that is already available:
  - Click **Browse** to navigate to the required file.
  - Click **Upload**.
- **Generate signing request** for a signing authority to create a new certificate:
  - Fill in all the required fields and click **Generate**.
- **Generate certificate** to create a new self-signed certificate:
  - Fill in all the required fields and click **Generate**.

### Delete a certificate from the file list

Click the trashcan icon to the right of the certificate. The Delete file window appears. To confirm deletion, click OK. To cancel deletion, click Cancel.

**Note:** You can only delete certificates that you have added; you cannot delete the default certificate.

## 11.4 Logging

### Current log level

Select the level of event for which to display log entries or to log.

### Number of displayed entries

Select the number of entries to display.

### Enable software sealing

Select this check box to enable software protection that prevents users from adjusting camera settings. This function also protects the camera from unauthorized access.

## 11.5 Diagnostics

Accesses the Built-in Self Test (BIST). The BIST displays status **Passed** or **Failed** on the most recent homing event, not a counter. For the other items, a counter is maintained.

Click the button **Start self-test** to show the number of times that the camera:

- performed a homing event.
- failed to home properly.
- restarted.
- lost video.

### Logs

This section updates automatically with the history of the camera and maintains a log of all events such as those listed below. Click the REFRESH button to reload log data.

## 11.6 System Overview

This window is for information only and cannot be modified. Keep this information at hand when seeking technical support.

Select the text on this page with a mouse and copy it so that it can be pasted into an e-mail if required.

## 12 Security and Safety Things

### 12.1 Applications

#### 12.1.1 Overview

When you access this page the first time, the message, "No apps found. Please install an app first." appears.

After you install apps, they appear in a list at the top of the page.

##### **App frame rate information**

When you access this page the first time, the message, "No frame rate data available" appears. After you install at least one app, the frame rate data appear in this part of the page.

##### **Get apps via S&ST App Management Portal or Configuration Manager**

##### **To get apps:**

1. Claim the camera (or a compatible ONVIF client) in the **Cloud Connection** page. Note: You must complete this step before you can install apps.
2. Click **Get apps**. Follow the prompts to install the app.

##### **To delete an app:**

1. Click the icon to the right of the line that displays the installed app. The icon changes to an 'x' and two other icons appear to the left.
2. Click the left icon (with the larger square).

##### **To stop an app:**

1. Click the icon to the right of the line that displays the installed app. The icon changes to an 'x' and two other icons appear to the left.
2. Click the middle icon (with the smaller square).

#### 12.1.2 Camera platform info

##### **Device ID**

This field displays the ID number of the device.

##### **OS**

This field displays the version of the operating system.

##### **Chipset**

This field displays the chipset of the device to which apps are installed.

##### **Supported SDK addon versions**

This field displays the supported versions of SDK addons.

#### 12.1.3 Crash reporting

This page allows users to send information about application crashes to the cloud. Note: Crash reporting must be enabled.

### 12.2 Bosch camera interface

In this section, you can see some configuration menus of the Bosch camera, such as privacy mask, network, stream configuration, and other menus.

### 12.3 Legal

This page provides legal information.

## 13 Operation via the browser

### 13.1 Live page

#### 13.1.1 Pre-positions

The camera displays **Pre-position 1** through **Pre-position 6**. Select the appropriate pre-position to view the video image for that pre-position/scene. In the lower left of the video image, the OSD displays the Camera number (title), the Pre-position number, and the Pre-position number stored.

Below the list of pre-positions/scenes is a drop-down list showing the stored pre-positions/scenes.

Select the appropriate pre-position (1 through 6). Click  to store the pre-position.

**Note:** If the pre-position is already stored, a dialog box displays the message, “**Overwrite current pre-position?**” Click **OK** to overwrite, or click **Cancel** to cancel the operation.

Click  to display the selected pre-position in the video image.

#### 13.1.2 AUX Control

With the tab **AUX Control** you can enter pre-programmed keyboard control commands. These commands are composed of a command number plus the appropriate function key (**Show pre-position**, **Set pre-position**, **AUX on**, or **AUX off**). A valid combination either issues a command to the device or displays an on-screen menu.

##### Show pre-position

Click this button to display a pre-position.

##### Set pre-position

Click this button to set a pre-position.

##### AUX on

Click this button to activate an AUX command.

##### AUX off

Click this button to deactivate an AUX command.

#### 13.1.3 Special Functions

##### Tour A / Tour B

Click one of these buttons to start the continuous playback of a recorded (guard) tour. A recorded tour saves all manual camera movements made during the recording, including its rate of pan, tilt and zoom speeds, and other lens setting changes.

To stop a tour, click a directional control in the View Control tab.

**Note:** **Tour B** is now intended for use with the 'IVA while moving' functions.

##### Focus

Click this button to activate the Auto Focus One Push mode on the camera.

The OSD displays the message, “Auto Focus: ONE PUSH.”

#### 13.1.4 Recording status

The hard drive icon  below the live camera image changes during an automatic recording. The icon lights up and displays a moving graphic to indicate a running recording. If no recording is taking place, a static icon is displayed.

### 13.1.5 Recording live video

Video sequences from the displayed live video stream can be saved locally on the computer's hard drive. The sequences are recorded at the resolution specified in the encoder configuration. The storage location depends on the configuration of the camera.



1. Click the recording icon  to record video sequences.
  - Saving begins immediately. The red dot on the icon indicates that a recording is in progress.
2. Click the recording icon again to stop recording.

### 13.1.6 Audio communication

Audio can be sent and received via the **Live** page if the unit and the computer support audio.

1. Press and hold the F12 key on the keyboard to send an audio signal to the unit.
2. Release the key to stop sending audio.

All connected users receive audio signals sent from the unit but only the user who first pressed the F12 key can send audio signals; others must wait for the first user to release the key.

### 13.1.7 Storage, CPU and network status

When you access the unit with a browser, the icons in the list that follows are at the top right corner of the window:



- CPU load icon
- Network load icon

The information from the icons can help with solving problems with the unit or with fine-tuning the unit.



Hover over the CPU load icon  to see the CPU load. If the CPU load is too high, change the VCA settings.

Hover over the Network load icon to see the network load. If the network load is too high, change the encoder profile to reduce the bitrate.

### 13.1.8

#### Status icons

Various overlays in the video image provide important status information. The overlays provide the following information:



##### Decoding error

The frame might show artifacts due to decoding errors.



##### Alarm flag

Indicates that an alarm has occurred.



##### Communication error

A communication error, such as a connection failure to the storage medium, a protocol violation or a timeout, is indicated by this icon.



##### Gap

Indicates a gap in the recorded video.



##### Watermark valid

The watermark set on the media item is valid. The color of the check mark changes according to the video authentication method that has been selected.



##### Watermark invalid

Indicates that the watermark is not valid.



##### Motion alarm

Indicates that a motion alarm has occurred.



##### Storage discovery

Indicates that recorded video is being retrieved.

## 13.2 Playback



Click **Playback** in the application bar to view, search or export recordings. This link is only visible when a direct iSCSI or memory card is configured for recording (with Video Recording Manager (VRM) recording this option is not active).

On the left side of the screen, there are four groups:

- **Connection**
- **Search**
- **Export**
- **Track list**

### 13.2.1 Selecting the recording stream

On the left side of the browser, expand the **Connection** group if necessary.

To view a recording stream:

1. Click the **Recording** drop-down arrow to see the options.
2. Select recording stream 1 or 2.

### 13.2.2 Searching for recorded video

On the left side of the browser, expand the **Search** group if necessary.

1. To limit the search to a particular time range, enter the date and times for the start and stop points.
2. Select an option from the drop-down box to define a search parameter.
3. Click **Search**.
4. The results are shown.
5. Click a result to play it back.
6. Click **Back** to define a new search.

### 13.2.3 Exporting recorded video

On the left side of the browser, expand the **Export** group if necessary.

1. Select a track in the track list or in the search results.
2. The start and stop date and time are filled-in for the selected track. If required, change the times.
3. In the **Time lapse** drop-down box, select the original or a condensed speed.
4. In the **Location** drop-down box, select a target.
5. Click **Export** to save the video track.

**Note:**

The target server address is set on the **Network / Accounts** page.

### 13.2.4 Track list

The **Track list** shows all the available recordings.

### 13.2.5 Controlling playback

The time bar below the video image allows quick orientation. The time interval associated with the sequence is displayed in the bar in gray. Arrows indicate the position of the image currently being played back within the sequence.

The time bar offers various options for navigation in and between sequences.

- If required, click in the bar at the point in time at which the playback should begin.
- Change the time interval displayed by clicking the plus or minus icons or use the mouse scroll wheel. The display can span a range from six months to one minute.

- Click the alarm jump buttons to go from one alarm event to the next or to the previous one. Red bars indicate the points in time where alarms were triggered.

#### **Controls**

Control playback by means of the buttons below the video image.

The buttons have the following functions:

- Start/Pause playback
- Select the playback (forward or backward) speed using the speed regulator
- Step forward or backward frame-by-frame when paused (small arrows)

## **13.3**

### **Dashboard**

The **Dashboard** page shows information on 4 topics:

- **Device status**
- **Recording status**
- **Connection Status**
- **Services**

You can also download a .JSON file with information about the device:

1. At the bottom of the page, locate the **Export** button
2. Click the **Export** button
3. Select a location in your hard drive to store the file

## 14 Recommended Use of Your Camera

Bosch recommends that you consider the following in order to optimize the life of your Bosch camera.



### Notice!

Refer to the document “AUTODOME\_OperationGuidelines\_2014.pdf” for guidelines for operating your camera using Guard Tours and Preset Tours. To access the document, go to [www.boschsecurity.com](http://www.boschsecurity.com), navigate to the product page for your camera, and then locate the document in the Documents tab.

### 1. Power-over-Ethernet (PoE)

Use the recommended Bosch High PoE 60W Midspan (sold separately from the camera) between the camera and your PoE network. Improper network connection can result in intermittent camera reboots. If the camera reboots frequently, test your camera with another power supply.

If you choose to use a PoE switch, ensure that the switch can support PoE+ (IEEE 802.3at, class 4 standard) devices to optimize its power management, and that the switch meets requirements for power draw for the product.



### Warning!

Only in-ceiling models of the AUTODOME can be connected to a PoE+ switch. Outdoor models should be used only with the Bosch High PoE 60W Midspan.

### 2. Installation in an area with high humidity

Ideally, the bubble of your dome camera should remain in place. The dome contains a desiccant pack to control the level of moisture inside the camera. Removing the bubble from the dome exposes the desiccant to moisture that could negatively affect the performance of the camera. If you must remove the bubble (for example, to install or remove an SD card), do not leave the bubble off of the dome for longer than five minutes.

Bosch also recommends that you keep the dome camera in its packaging until you are ready to install the camera.

### 3. Installation in a corrosive environment (for example, near a coastline)

The fasteners and fixtures shipped with the camera help to keep the camera secure. Always use Bosch-supplied screws and other fasteners when installing or performing maintenance on the camera.

Before installation, inspect the metal parts of the camera for paint that is chipped or otherwise damaged. If you notice any paint damage, touch up the damage with locally available paint or sealants.

Avoid installation practices that may bring the camera's metal mountings in contact with materials such as stainless steel. Such contacts can result in galvanic corrosion and degrade the cosmetic appearance of the camera. These cosmetic damages caused by improper installation are not covered by warranty as they do not affect the functionality of the camera.

### 4. Outdoor installation

Use proper surge suppression on your network video, power, audio, and alarm cables.

### 5. SD card

This information is provided to assist the customer in the selection of an appropriate SD device as a means for recording video. It is not an endorsement of a specific technology or supplier.



AUTODOME 7000 Series cameras can record video and audio to user-supplied local memory cards (SD, SDHC, or SDXC, hereafter referred to as “SD cards”). Bosch has identified best practices with respect to the selection and use of SD cards in the products.

1. Select an SD card with a read/write speed of at least 10MB/second and class 6.
2. Ensure that write protection is off. (Check the slider if applicable.)
3. Switch off power to the unit before inserting the SD card.
4. Stop recording and switch off power to the unit before removing the SD card.

Bosch recommends that you frequently check the recording status of your equipment.

Periodic replacement of the SD card may be required. It is recommended that redundant recording systems are considered and that information is always backed up. As with all storage media, the “lifetime” of an SD card varies by supplier and use conditions. The lifetime of a SD card is normally dependent on the number of read/write activities.

Bosch provides this guidance as a service to our customers with no representation of warranty, either expressed or implied, associated with the use of SD cards for recording.

Bosch is not liable for any damage that results from missing video information. Bosch does not make any commitments or promises regarding quality, performance, or other features with respect to third party products (such as SD cards).

## 15 Troubleshooting

If you experience difficulties operating your AUTODOME camera, refer to the following. If the guidelines do not enable you to solve the problem, contact an authorized technician.

Problem	Questions to Ask/Actions to Resolve the Problem
Need to remove trim ring.	Use a slotted screw driver and push the clips outward while gently pulling down on the edge of the trim ring.
Nothing appears on the screen.	Are the power cord and line connection between the camera and network made properly?
The image on the screen is dim.	Is the lens dirty? If so, clean the lens with a soft, clean cloth.
The contrast on the screen is too weak.	Adjust the contrast feature of the monitor. Is the camera exposed to strong light? If so, change the camera position.
The image on the screen is flickers.	Does the camera face directly into the sun or fluorescent lighting? If so, reposition camera.
The image on the screen is distorted.	Is the power frequency set properly in sync? If the power frequency is not set correctly, the line lock synchronization mode cannot be used. Set the synchronization mode to INT.NTSC Model power frequency in LL mode: 60 Hz.
No video	<ul style="list-style-type: none"> <li>– Check that the mains power to the power supply is on.</li> <li>– Check to see if you have a web page. If you do not, then you may have the wrong IP address. Use Configuration Manager to identify the correct IP address.</li> </ul> <p><b>If OK, then:</b></p> <ul style="list-style-type: none"> <li>– Check that there is 24 V output from the transformer.</li> </ul> <p><b>If OK, then:</b></p> <ul style="list-style-type: none"> <li>– Check the integrity of all wires and mating connectors to the camera.</li> </ul> <p><b>If OK, then:</b></p> <ul style="list-style-type: none"> <li>– Reset the camera to factory defaults. (Refer to the Troubleshooting section “Physical reset button.”)</li> </ul>
No camera control	<ul style="list-style-type: none"> <li>– Ensure that the LAN cable has good connection and is secured.</li> <li>– Refresh the browser and ensure that video is updated.</li> <li>– Ping the camera’s IP address and try again to control the camera.</li> </ul> <p><b>If OK, then:</b></p> <ul style="list-style-type: none"> <li>– Reset the camera to factory defaults. (Refer to the Troubleshooting section “Physical reset button.”)</li> </ul>
Camera moves when moving other cameras	<ul style="list-style-type: none"> <li>– Check that the camera’s IP address is properly set.</li> </ul> <p><b>If camera’s IP address is not set, then:</b></p> <ul style="list-style-type: none"> <li>– Use Configuration Manager to confirm that two cameras do not have the same IP address. If they do, change the address of one of the cameras.</li> </ul>
Picture is dark	<ul style="list-style-type: none"> <li>– Check that the Gain Control is set to <b>High</b> via the Settings menu.</li> </ul> <p><b>If OK, then:</b></p> <ul style="list-style-type: none"> <li>– Check that the Auto Iris Level is set to the appropriate level via the Settings menu.</li> </ul> <p><b>If OK, then:</b></p> <ul style="list-style-type: none"> <li>– Check that the camera lens cover is removed.</li> </ul>

Problem	Questions to Ask/Actions to Resolve the Problem
	<p><b>If OK, then:</b></p> <ul style="list-style-type: none"> <li>- Check that the maximum Ethernet cable distance has not been exceeded.</li> </ul> <p><b>If OK, then:</b></p> <ul style="list-style-type: none"> <li>- Restore all camera settings via the Settings menu.</li> </ul>
Background is too bright to see subject	<ul style="list-style-type: none"> <li>- Turn on backlight compensation via the Settings menu (or by using 20 Aux ON/OFF).</li> </ul>
Video is rolling, noisy or distorted	<ul style="list-style-type: none"> <li>- Check the frequency. <ul style="list-style-type: none"> <li>- From the <b>SETTINGS</b> page, click <b>Advanced Mode</b>.</li> <li>- Click <b>Camera</b>, and then click <b>Installer Menu</b>.</li> <li>- In the <b>Base frame rate</b> field, choose either 25 ips or 30 ips.</li> </ul> </li> <li>- Check the integrity of all connectors and splices of the Ethernet cable.</li> </ul> <p><b>If OK, then:</b></p> <ul style="list-style-type: none"> <li>- Contact Bosch Technical Support.</li> </ul>
Loss of Privacy when using Privacy Mask	<ul style="list-style-type: none"> <li>- Web browsers, BVC or BVMS <ul style="list-style-type: none"> <li>- Press the <b>FindHome</b> key on the Special Functions menu in order to align the mask back to the original position.</li> </ul> </li> <li>- Intuikey (when keyboard is connected to BVC or BVMS <ul style="list-style-type: none"> <li>- Issue a <b>SetScene 110</b> command in order to align the mask back to the original position.</li> </ul> </li> </ul>
No Network Connection	<ul style="list-style-type: none"> <li>- Check all network connections. <ul style="list-style-type: none"> <li>- Ensure that the maximum distance between any two Ethernet connections is 100 m (328 ft) or less.</li> </ul> </li> </ul> <p><b>If OK, then:</b></p> <ul style="list-style-type: none"> <li>- If you are behind a firewall, ensure that the Video Transmission mode is set to UDP. <ul style="list-style-type: none"> <li>- Access the Settings Web page for the IP-enabled device.</li> <li>- Expand the Service Settings link, then click Network.</li> <li>- Select UDP from the Video Transmission drop-down list. Then click Set.</li> </ul> </li> </ul>

## 15.1 Physical reset button

Each camera has a hardware reset button. You may need to press the reset button to reset the camera to factory defaults if you encounter the following circumstances:

- You can power up the camera but cannot log on to the camera using the web browser.
- The camera doesn't start up, or fails to power up via PoE.
- The camera cannot search an IP address.
- The camera's firmware crashed.
- You forgot the password to access the camera.
- The image becomes frozen.
- You cannot update the firmware.
- The camera disconnects from the network at random and needs a reboot.
- The camera no longer finds pre-positions (preset positions).
- You cannot configure the camera using the web browser.
- The camera has no video out.

**Notice!**

A factory default deletes all camera settings including passwords, network settings, and image settings.

Complete the following sequence of steps only if you have no other option to restore operation to the camera.

**Steps to complete a hardware reset for all camera models**

1. Apply power to the camera.
2. Find the IP address of the camera.
3. Log on to the camera using the web browser. (**Note:** You can use Configuration Manager to identify the IP address.)
4. Find the hardware reset button on the camera. (Refer to the figure below to find the reset button for your camera model.)
5. Push and hold the reset button for more than 8 seconds. The red LED indicator on the PCBA board will come on to show that the hardware reset started.

**Note:** You can also use a conductive wire to short the terminal block.

1. Let the camera complete a self-check. When the self-check completes, the red LED will go off.
2. Find the IP address again.
3. Access the camera using the web browser.
4. Set the initial **service**-level password for the camera.

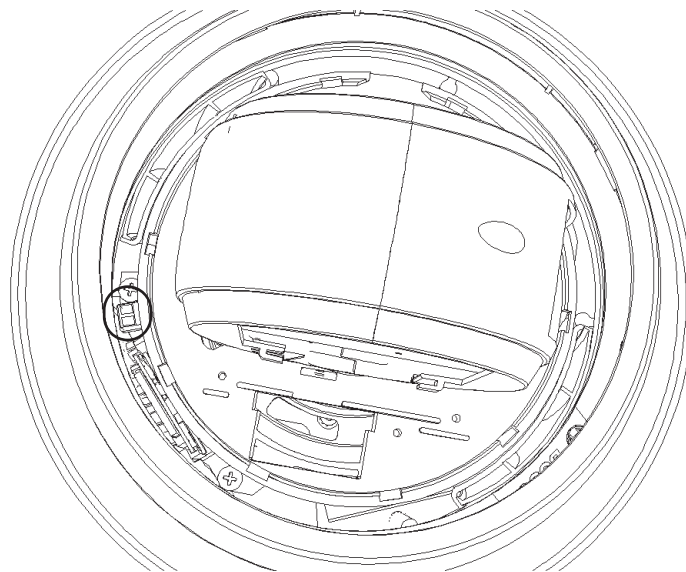

---

## 16 Status Codes

Most status codes appear on the OSD until you acknowledge them. The codes identified with asterisks (\*\*) appear for approximately 10 seconds, then disappear automatically.

The Hard Pan Limits feature is for MIC cameras only.

Washer and wiper apply to MIC cameras only.



### **Caution!**

If you choose not to use a switch or midspan with the appropriate Power Sourcing Equipment (PSE) chip, then the camera will not recognize the PoE as compliant, and the camera firmware may disable some or all functionality.

---

## 17 AUX Commands

AUX	Function	Command	Description
1	On/Off	Auto Pan without limits (Continuous)	
2	On/Off	Auto Pan between limits	
7	On/Off	Run Custom Pre-Position Tour	
8	On/Off	Run Pre-Position Tour	
18	On/Off	AutoPivot Enable	
20	On/Off	Backlight Compensation (BLC)	
24	On/Off	Video Stabilization	
40	On/Off	Restore camera settings [to factory defaults]	
43	On/Off	Auto Gain Control (AGC)	
50	On/Off	Playback A, continuous	
51	On/Off	Playback A, single	
52	On/Off	Playback B, continuous	
53	On/Off	Playback B, single	
57	On/Off	Night mode IR Filter In/Out	
60	On/Off	On-Screen Display (OSD)	
61	On/Off	Preset & Sector Titles Camera Block Overlay VDSK not required	
65	Off	Alarm Acknowledge	Acknowledges alarm events/rules or deactivates physical outputs.
67	On/Off	IR Focus Correction	
78	On/Off	Intelligent Tracking	
80	On/Off	Digital Zoom lock	
86	On/Off	Sector Blanking	
87	On/Off	Privacy Masking	
88	On/Off	Proportional Speed	
94	On/-	Recalibrate Azimuth Compass	
95	On/Off	Azimuth/Elevation Display	
96	On/Off	Compass Points Display	
100	On/Off	Record Tour A	
101	On/Off	Record Tour B	
102	On/Off	Wiper On/Off (Continuous)	

<b>AUX</b>	<b>Function</b>	<b>Command</b>	<b>Description</b>
103	On/Off	Wiper On/Off (Intermittent)	
104	On/Off	Wiper On/Off (One shot)	
105	On/Off	Wash/Wipe On/Off	
121	On/Off	Left Hard Pan Limit	
122	On/Off	Right Hard Pan Limit	
123	On/Off	Clear Hard Pan Limits	
606	On/Off	Power Mode	
700	On/Off	Proportional speed control adjustment	Aux On, entered repeatedly, cycles through increasing speeds Super Slow, Slow, Medium, and Fast. Aux Off, decreases speeds through the same settings.
804	On/Off	Mask Calibration Procedure	
908		Increase Privacy Mask Size while moving	
1-256	Set/-	Pre-position Programming	
1-256	-/Shot	Pre-position Recall	

# 18

## Support



### Support

Access our **support services** at [www.boschsecurity.com/xc/en/support/](http://www.boschsecurity.com/xc/en/support/).

Bosch Security and Safety Systems offers support in these areas:

- [Apps & Tools](#)
- [Building Information Modeling](#)
- [Commissioning](#)
- [Warranty](#)
- [Troubleshooting](#)
- [Repair & Exchange](#)
- [Product Security](#)



### Bosch Building Technologies Academy

Visit the Bosch Building Technologies Academy website and have access to **training courses**, **video tutorials** and **documents**: [www.boschsecurity.com/xc/en/support/training/](http://www.boschsecurity.com/xc/en/support/training/)











**Bosch Security Systems B.V.**

Torenallee 49

5617 BA Eindhoven

Netherlands

**[www.boschsecurity.com](http://www.boschsecurity.com)**

© Bosch Security Systems B.V., 2020