

FLEXIDOME IP panoramic 7000 - outdoor

www.boschsecurity.com



BOSCH
Invented for life



- ▶ 12MP / 30 fps sensor for fine details with smooth motion
- ▶ Edge or client-side dewarping for easy integration
- ▶ Built-in Intelligent Video Analytics to trigger relevant alerts and quickly retrieve data
- ▶ Outdoor IP panoramic camera
- ▶ Compatible with Bosch universal accessories

The FLEXIDOME IP panoramic 7000 is an outdoor use camera. The 12MP sensor operating at 30 fps gives a full panoramic surveillance with complete area coverage, fine details and high speeds. The camera offers full situational awareness and simultaneous E-PTZ views in high resolution.

Versions

The 360° version of the camera, when mounted centrally on a pole or under an eave, gives complete surround coverage without blind spots. The 180° version has a higher effective resolution and is ideal for wall mounting in perimeter surveillance by obtaining a seamless 180° coverage.

Dewarping

The lens captures a circular image. Our dewarping software transforms this circular image into several different distortion-free rectangular views. To facilitate system integration, you can choose edge dewarping inside the camera or client-side dewarping on an external platform.

The freely available Video Security Client from Bosch provides advanced client-side dewarping features.

System overview

Advantages of panoramic surveillance

Panoramic surveillance offers full 180° or 360° coverage of the designated area. Because our panoramic cameras cover the full area, they provide complete situational awareness and are ideally suited to following movement in one continuous sweep.

180°



360°

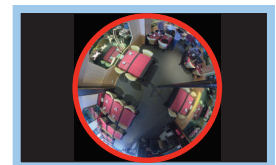

These panoramic cameras will considerably augment the functionality of any high-end surveillance system especially when coupled with Intelligent Video Analytics, for example, for people counting or complex rule-based alarm triggering.

Intelligent Video Analytics continuously monitors the full image circle so you still receive alarms even if you are zoomed-in on a particular region.

Functions

12MP sensor at 30 fps

The ultra high 12MP sensor resolution together with the exceptionally high frame rate of 30 fps makes this camera unique in the field of panoramic image capture. Motion is smoother and the E-PTZ feature provides more detailed images.

The effective resolution for the 180° version is 8MP and for the 360° version 7MP.

Video Analytics

The system reliably detects, tracks, and analyzes objects, and alerts you when predefined alarms are triggered. A smart set of alarm rules makes complex tasks easy and reduces false alarms to a minimum. Video analytics adds sense and structure to your video by adding metadata. Metadata is generated from the full image circle and also separately on the E-PTZ channel. This enables you to quickly retrieve the relevant images from hours of stored video. Metadata can also be used to deliver irrefutable forensic evidence or to optimize business processes based on people counting or crowd density information.

Panoramic vision and Intelligent Video Analytics

The camera uses the latest generation of the Bosch Intelligent Video Analytics software. This software, combined with full panoramic vision, produces an extremely powerful surveillance tool which enriches full situational awareness. With intelligent tracking, movement can be followed continuously throughout the full image circle. There is no need to hand off tracking from one camera to another, greatly simplifying movement analysis.

MOTION+

The MOTION+ video motion analysis system that is built into all camera versions is the perfect solution for applications where basic video content analysis features are required. MOTION+ shows motion metadata in an overlay display. By using MOTION+ data as input, smarter imaging algorithms bring improved image quality and more efficient bitrates. It also enables extended tamper detection capabilities.

Client-side dewarping

With client-side dewarping, the camera streams a single circular non-dewarped image at 30 fps. Dewarping is performed with our dewarping software that is installed on the PC where multiple view modes are available or you can choose to use a third-party client-side dewarping software solution.

Edge dewarping

The edge dewarping in the camera provides three separate video channels simultaneously at 12.5 fps:

- Full image circle (Video 1 channel)
- Dewarped view mode (Video 2 channel)
- E-PTZ (Video 3 channel)

Different view modes can be selected for the video 2 channel. Your selection depends on the resolution you require and how you wish to view the dewarped image.

View modes



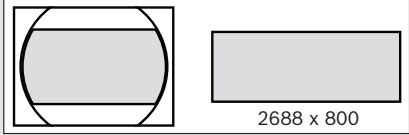
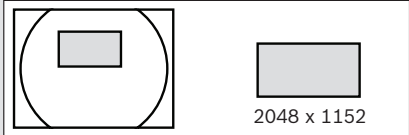
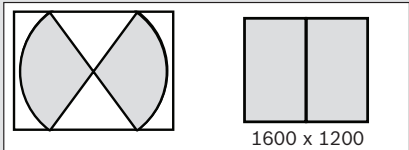

The following view modes can be selected at 12.5 fps with edge dewarping or 30 fps with our client side dewarping.

With the 180° lens version, you can select one of the following view modes for the second channel:

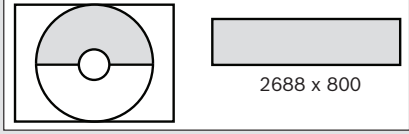
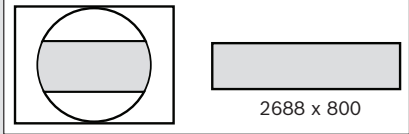
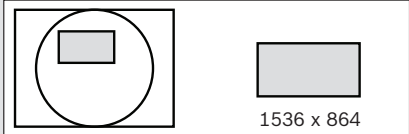
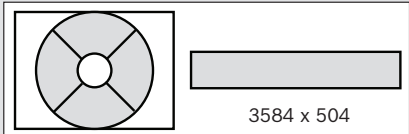
180° lens version	Full image cut-out and displayed image
Panoramic view	
E-PTZ view	
Corridor view	

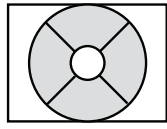
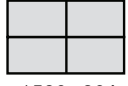
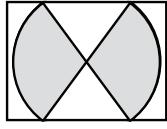
With the 360° lens version, select one of the following view modes for the second channel:

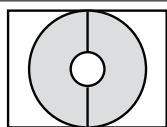
360° lens version	Full image cut-out and displayed image
Panoramic view (ceiling mount)	
Panoramic view (wall mount)	
E-PTZ view	
Full panoramic view	

360° lens version	Full image cut-out and displayed image	
Quad view		 1536x 864
Corridor view		 1600 x 1200
Double panoramic view		 1920 x 1080

DORI coverage

DORI (Detect, Observe, Recognize, Identify) is a standard system (EN-62676-4) for defining the ability of a camera to distinguish persons or objects within a covered area. The maximum distance at which a camera/lens combination can meet these criteria is shown below:

For high mounting applications, the center image DORI values are:

DORI	Object distance - 180°	Object distance - 360°
Detect	55 m (181 ft)	42 m (138 ft)
Observe	22 m (72 ft)	16.5 m (54 ft)
Recognize	10.5 m (35 ft)	8.5 m (28 ft)
Identify	5.5 m (18 ft)	4 m (13 ft)

When mounted at a height of 3 m (10 ft) the 180° version of the camera has the following coverage radius for the four levels:

DORI	DORI definition	Coverage radius
Detect	25 px/m (8 px/ft)	28 m (92 ft)
Observe	63 px/m (19 px/ft)	12 m (40 ft)
Recognize	125 px/m (38 px/ft)	6.5 m (22 ft)
Identify	250 px/m (76 px/ft)	3.5 m (12 ft)

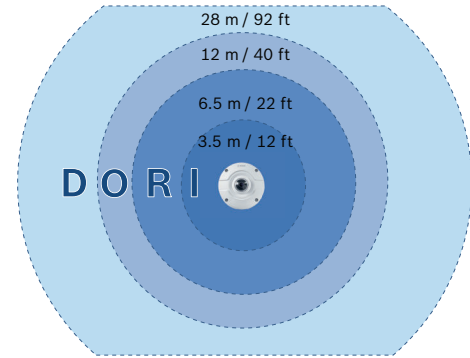

When mounted at a height of 3 m (10 ft) the 360° version of the camera has the following coverage radius for the four levels:

DORI	DORI definition	Coverage radius
Detect	25 px/m (8 px/ft)	19 m (62 ft)
Observe	63 px/m (19 px/ft)	8.5 m (28 ft)
Recognize	125 px/m (38 px/ft)	4.5 m (15 ft)
Identify	250 px/m (76 px/ft)	2 m (7 ft)

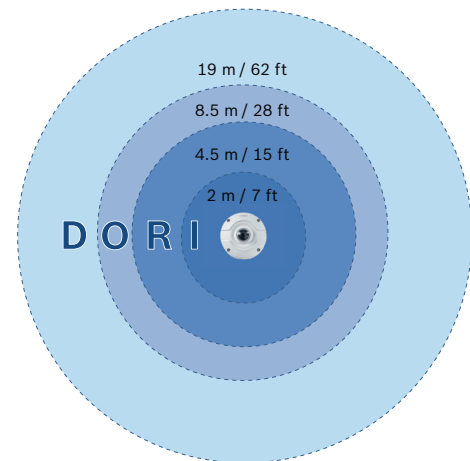

E-PTZ and regions of interest

The remote E-PTZ (Electronic Pan, Tilt and Zoom) controls allow you to select specific areas of the full image circle. These Regions of Interest (ROI) can be easily defined, allowing the most interesting part of a scene to be monitored separately. The high resolution ensures that details are not lost even when using the electronic zoom.

The E-PTZ feature of a panoramic camera has some advantages over normal PTZ cameras. There is no camera movement so the camera does not draw attention to itself or appear intrusive. Situational awareness is still retained even when zooming in on a

particular object of interest. The smooth E- PTZ function helps navigation, and presets are available as they are with regular PTZ cameras.

Record exactly what you want

The camera provides the full resolution circular image for recording even if you are viewing only a portion of the scene. This means that you can always perform retrospective dewarping and analyses on the complete area covered and then zoom in on the region or object of interest.

With edge-dewarping you can also choose to only record the relevant parts of the scene which helps reduce bitrates significantly.

Intelligent streaming

Smart encoding capabilities, together with Intelligent Dynamic Noise Reduction technology and analytics, make the bandwidth consumption drop to extremely low levels. Only relevant information in the scene, such as motion or objects found with the analytics, are encoded.

Each of these streams can be adapted independently to deliver high quality video, perfectly tailored to purpose, while reducing bit rate by up to 90% compared to a standard camera.

Area-based encoding

Area-based encoding is another feature which reduces bandwidth. Compression parameters for up to eight user-definable regions can be set. This allows uninteresting regions to be highly compressed, leaving more bandwidth for important parts of the scene. Area-based encoding is only available with client-side dewarping.

Bitrate optimized profile

The average typical optimized bandwidth in kbits/s for various image rates is shown in the table:

fps	12MP (full image circle)	Dewarped ROI (720p)
30	3100	-
25	2921	-
20	2640	-
12.5	2305	491
10	2192	432
5	1530	303
2	655	130

Measured dynamic range

The dynamic range of the camera is outstanding and is obvious in real-world performance comparisons – 92 dB wide dynamic range (plus an extra 16 dB when combined with Intelligent Auto Exposure).

The actual dynamic range of the camera is measured using Opto-Electronic Conversion Function (OECF) analysis with a standardized test chart based on ISO

standards. This method provides more realistic and verifiable results in comparison with the theoretical approximations sometimes used.

Priority exposure control

To optimize image quality, eight zones for measuring the exposure can be drawn on the full image circle and assigned a priority level. These zones are given a higher or lower priority when the camera calculates the exposure level. This ensures that the important areas of the scene have the ideal exposure level.

Intelligent Auto Exposure

Fluctuations in backlight and front light can ruin your images. To achieve the perfect picture in every situation, Intelligent Auto Exposure automatically adjusts the exposure of the camera. It offers superb front light compensation and incredible backlight compensation by automatically adapting to changing light conditions.

Outdoor design

The camera is exceedingly suitable for outdoor installations where movement is a constant, such as parking lots, school areas and squares. This gives a single solution for outdoor environments with an integrated IP66/IK10 design, as well as compatibility with Bosch universal accessories.

The LED indicators, reset button and SD card slot are easily accessed. A complete set of outdoor mounting accessories, such as a surface mount box, a pendant pipe, wall or ceiling mount, are available.

Power for the camera is supplied via a Power-over-Ethernet compliant network cable connection. With this configuration, only a single cable connection is required to view, power, and control the camera.

Scene modes

The camera has a very intuitive user interface that allows fast and easy configuration. Nine configurable modes are provided with the best settings for a variety of applications. Different scene modes can be selected for day or night situations.

Storage management

Recording management can be controlled by the Bosch Video Recording Manager (Video Recording Manager) or the camera can use iSCSI targets directly without any recording software.

Edge recording

Insert a memory card into the card slot to store up to 2 TB of local alarm recording. Pre-alarm recording in RAM reduces recording bandwidth on the network, and extends the effective life of the memory card.

It has advanced edge recording providing a reliable storage solution possible due to the combination of these functions:

- Industrial SD card support allows for extreme lifetime
- Health monitoring of industrial SD cards provide early service indications.

Cloud-based services

The camera supports time-based or alarm-based JPEG posting to four different accounts. These accounts can address FTP servers or cloud-based storage facilities (for example, Dropbox). Video clips or JPEG images can also be exported to these accounts.

Alarms can be set up to trigger an e-mail or SMS notification so you are always aware of abnormal events.

Access security

Password protection with three levels and 802.1x authentication is supported. To secure Web browser access, use HTTPS with a SSL certificate stored in the camera.

Complete viewing software

There are many ways to access the camera's features: using a web browser, with the Bosch Video Management System, with the free-of-charge Bosch Video Client or Video Security Client, with the video security mobile app, or via third-party software.

System integration and ONVIF conformance

The camera conforms to the Open Network Video Interface Forum (ONVIF) Profile S and Profile G specifications. Compliance with these standards guarantees interoperability between network video products regardless of manufacturer. Third-party integrators can easily access the internal feature set of the camera for integration into large projects. Visit the Bosch Integration Partner Program (IPP) website (ipp.boschsecurity.com) for more information.

Certifications and approvals

Standards	Type
Emission	EN 50121-4: 2016; EN55032: 2015, AC: 2016; CFR 47 FCC part 15 : 2012-10-1, Class B
Environmental	EN 50581 (2012)
Environmental Tests	EN 50130-4: 2011, A1: 2014
Immunity	EN 50121-4: 2016; EN 50130-4: 2011, A1: 2014
Marks	CE, cULus, WEEE, RCM, EAC and China RoHS
Safety	EN 60950-1: 2006, A11: 2009, A1: 2010, A12: 2011, A2: 2013; UL 60950-1, 2nd edition; CAN/CSA-C 22.2 No. 60950-1-07, 2nd edition; EN 60950-22: 2006, A11: 2008; UL 60950-22, 1st edition; CSA C22.2 NO. 60950-22-07 Edition 1

Standards	Type
Impact protection	EN 62262 (IK10)
Ingress protection	EN 60529 (IP66)

*All systems where this camera is used must comply with this standard as well.

Region	Regulatory compliance/quality marks	
Europe	CE	EU_CE Declaration of Conformity

Installation/configuration notes

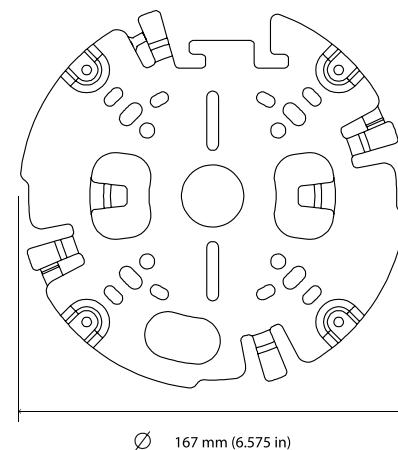
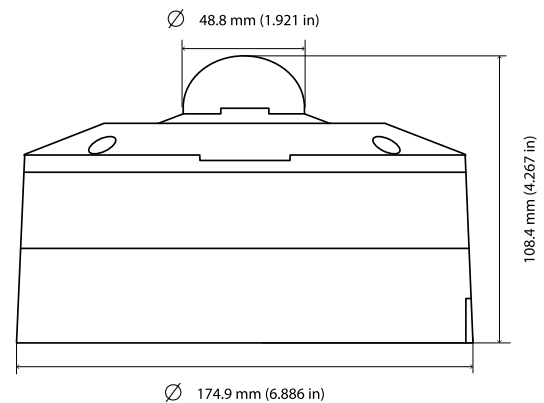

Technical specifications**Power**

Power Supply	Power-over-Ethernet 48V DC nominal
Power Consumption	200 mA
PoE	IEEE 802.3af (802.3at Type 1)

Sensor

Type	1/2.3-inch CMOS
Total sensor pixels	12MP
Used pixels (180° version)	3648 x 2160 (8MP)
Used pixels (360° version)	2640 x 2640 (7MP)

Video performance – Sensitivity – 180° lens

(3100K, reflectivity 89%, F2.8, 30IRE)

Color	0.46 lx
Mono	0.15 lx

Video performance – Sensitivity – 360° lens

(3100K, reflectivity 89%, F2.8, 30IRE)

Color	0.55 lx
Mono	0.18 lx

Video performance – Dynamic range

Dynamic range	92 dB WDR (+16 dB IAE)
---------------	------------------------

Video streaming

Video compression	H.264 (MP); M- JPEG
Streaming	Multiple configurable streams in H.264 and M-JPEG, configurable frame rate and bandwidth. Multiple channels with edge dewarping. Regions of Interest (ROI)
Overall IP Delay	Min. 120 ms, Max. 340 ms
Encoding interval	1 to 25 [30] ips
Encoder regions	Eight independent areas for setting encoder quality to optimize bitrate.

Video resolution (H x V) – 180° version

Video 1 channel	Image circle	3640 x 2160
Video 2 channel	Panoramic	2688 x 800
	E-PTZ	2048 x 1152
	Corridor	1600 x 1200
Video 3 channel	E-PTZ	1280 x 720

Video resolution (H x V) – 360° version

Video 1 channel	Full image circle	2640 x 2640
Video 2 channel	Full panoramic	3584 x 504
	E-PTZ	1536 x 864
	Quad	1536 x 864
	Panoramic	2688 x 800
	Double panoramic	1920 x 1080
	Corridor	1600 x 1200
Video 3 channel	E-PTZ	1280 x 720

Video functions

Day/Night	Color, Monochrome, Auto (adjustable switchover points)
Adjustable picture settings	Contrast, Saturation, Brightness
White Balance	2500 to 10000K, 4 automatic modes (Basic, Standard, Sodium vapor, Dominant color), Manual mode and Hold mode
Shutter	Automatic Electronic Shutter (AES) Fixed (1/30 [1/25] to 1/15000) selectable Default shutter
Sharpness	Sharpness enhancement level selectable
Backlight compensation	Off / On / Intelligent Auto Exposure (BLC)
Contrast enhancement	On/off
Noise reduction	Intelligent Dynamic Noise Reduction Intelligent Streaming
Intelligent defog	Intelligent defog automatically adjusts parameters for best picture in foggy or misty scenes (switchable)
Exposure region	Multiple selectable regions

Video functions	
Privacy Masking	Eight independent areas, fully programmable
Scene modes	9 default modes with scheduler
Video Content Analysis	MOTION+ and Intelligent Video Analytics
Pre-positions	Six independent sectors
Display stamping	Individual names and stamps for all video channels
Other functions	Pixel counter, Video watermarking, Location

Optical	
Lens (180° version)	2.1 mm fixed-focus lens (IR corrected), F2.8
Lens (360° version)	1.6 mm fixed-focus lens (IR corrected), F2.8
Lens mount	Board mounted
Iris control	Fixed iris
Field of view (180° version)	180° (H) x 93° (V)
Field of view (360° version)	180° (H) x 180° (V)
Minimum object distance	0.1 m
Day/Night	Switched mechanical IR filter

Local storage	
Internal RAM	10 s pre-alarm recording
Memory card slot	SDXC/SDHC SD card slot
Recording	Continuous recording, ring recording, alarm/events/schedule recording
Industrial SD cards	Extreme lifetime and health monitoring support that provides early service indication. Recommended: Industrial SD cards with health monitoring

Software	
Unit discovery	IP Helper
Unit configuration	Via web browser or Configuration Manager
Firmware update	Remotely programmable

Software	
Software viewing	Web browser or third party software.
Latest firmware and software	http://downloadstore.boschsecurity.com/

Network	
Protocols	IPv4, IPv6, UDP, TCP, HTTP, HTTPS, RTP/RTCP, IGMP V2/V3, ICMP, ICMPv6, RTSP, FTP, ARP, DHCP, APIPA (Auto-IP, link local address), NTP (SNTP), SNMP (V1, V3, MIB-II), 802.1x, DNS, DNSv6, DDNS (DynDNS.org, selfHOST.de, no-ip.com), SMTP, iSCSI, UPnP (SSDP), DiffServ (QoS), LLDP, SOAP, Dropbox™, CHAP, digest authentication, Stratocast™ Genetec
Encryption	TLS1.0/1.2, AES128, AES256
Ethernet	10/100 Base-T, auto-sensing, half/full duplex
Connectivity	Auto-MDIX
Interoperability	ONVIF Profile S; ONVIF Profile G; ONVIF Profile T GB/T 28181

Mechanical	
Dimensions (∅ x H)	174.9 x 108.4 mm (6.886 x 4.267 in)
Weight	2.06 kg (4.54 lbs)
Color	White (RAL9003)

Environmental	
Operating Temperature	-30°C to +45°C (-22°F to 113°F)
Storage Temperature	-20°C to +60°C (-4°F to 140°F)
Operating Humidity	5% to 93% RH non-condensing 5% to 100% RH condensing
Storage Humidity	Up to 98% RH
Impact Protection	IK10
Ingress Protection	IP66
Sustainability	PVC free

Ordering information

NDS-7004-F180E Fixed dome 12MP 180° IVA IP66

High-performance 12MP sensor camera for intelligent 180° panoramic outdoor surveillance.

Built-in Intelligent Video Analytics

Order number **NDS-7004-F180E**

NDS-7004-F360E Fixed dome 12MP 360° IVA IP66

High-performance 12MP sensor camera for intelligent 360° panoramic outdoor surveillance.

Built-in Intelligent Video Analytics

Order number **NDS-7004-F360E**

Accessories

NDA-8000-PIPW Pendant interface plate, outdoor

Pendant interface plate including weather protector for FLEXIDOME IP 8000i and FLEXIDOME IP panoramic 6000/7000 outdoor.

Order number **NDA-8000-PIPW**

NDA-8000-PIP Pendant interface plate, indoor

Pendant interface plate for FLEXIDOME IP 8000i and FLEXIDOME IP panoramic 6000/7000 outdoor.

Order number **NDA-8000-PIP**

NDA-U-PMT Pendant pipe mount, 12" (31cm)

Universal pipe mount for dome cameras, 31 cm, white

Order number **NDA-U-PMT**

NDA-U-PMTE Pendant pipe extension, 20" (50cm)

Extension for universal pipe mount, 50 cm, white

Order number **NDA-U-PMTE**

NPD-5001-POE Power over ethernet , 15.4W, 1-port

Power-over-Ethernet midspan injector for use with PoE enabled cameras; 15.4 W, 1-port

Weight: 200 g (0.44 lb)

Order number **NPD-5001-POE**

NPD-5004-POE Power over ethernet, 15.4W, 4-port

Power-over-Ethernet midspan injectors for use with PoE enabled cameras; 15.4 W, 4-ports

Weight: 620 g (1.4 lb)

Order number **NPD-5004-POE**

NPD-3001-WAP Portable installation tool

Bosch camera portable and wireless installation tool

Order number **NPD-3001-WAP**

NDA-U-WMT Pendant wall mount

Universal wall mount for dome cameras, white

Order number **NDA-U-WMT**

NDA-U-PSMB Pendant wall/ceiling mount SMB

Surface mount box (SMB) for wall mount or pipe mount.

Order number **NDA-U-PSMB**

Represented by:

Europe, Middle East, Africa:
Bosch Security Systems B.V.
P.O. Box 80002
5600 JB Eindhoven, The Netherlands
Phone: + 31 40 2577 284
emea.securitysystems@bosch.com
emea.boschsecurity.com

Germany:
Bosch Sicherheitssysteme GmbH
Robert-Bosch-Ring 5
85630 Grasbrunn
Germany
www.boschsecurity.com

North America:
Bosch Security Systems, Inc.
130 Perinton Parkway
Fairport, New York, 14450, USA
Phone: +1 800 289 0096
Fax: +1 585 223 9180
onlinehelp@us.bosch.com
www.boschsecurity.us

Asia-Pacific:
Robert Bosch (SEA) Pte Ltd, Security Systems
11 Bishan Street 21
Singapore 573943
Phone: +65 6571 2808
Fax: +65 6571 2699
apr.securitysystems@bosch.com
www.boschsecurity.asia