

DSP-20

Dual Channel Vehicle Detector With Directional Logic



Diablo Controls, Inc.
 Copyright © 2014
 Document: DSP20_MAN_A
 Released: March 30, 2014



Pros Who Know Trust Diablo

1. Contents

2. Introduction.....	3
3. Technical Data	4
Functional Data.....	4
Electrical Data.....	4
Environmental Data.....	4
Mechanical Data	5
4. Features and Functions	6
Operating Modes.....	6
Presence Detection.....	6
Pulse Detection.....	7
Sensitivity.....	7
Sensitivity Boost	7
Fail-Safe vs Fail-Secure	7
Fail-Safe	8
Fail-Secure	8
Detector Reset.....	8
Channel Reset.....	8
Indicators.....	9
5. Installation.....	12
Detector Installation.....	12
Loop Installation	12
6. Configuration.....	15
DIP Switches	15
Wiring	17
7. Troubleshooting	19
No Power LED	19
Flashing Power LED.....	19
A Channel LED Flashes Slowly (1 Hz)	19
A Channel LED Flashes Quickly (5 Hz).....	20
A Channel LED Shows Two Quick Flashes Once Every Two Seconds	20
A Channel LED Intermittently Comes On / Stays On Without a Vehicle Present.....	21
A Channel LED Will Not Come On With a Vehicle Present.....	22

2. Introduction

The DSP-20 is intended to be a general purpose two channel vehicle detector designed for the parking and access control industries. The small package is powered by a high performance 16-bit microcontroller that does not skimp on performance.

The DSP-20 can operate as two independent channels or in a directional logic mode that allows the detector to activate an output based on the vehicle's direction of travel.

The DSP-20 is a dual channel detector that uses advanced channel scanning technology to provide superior noise tolerance. The scanning technology allows for placement of loops closer together (even overlapping) than ever possible with single channel detectors.

The DSP-20 continually monitors the loop circuit looking for conditions that would signify a fault in the loop circuit and displays the type of fault identified. This helps quickly identify open or shorted loops. Fault memory alerts the user to past faults that have automatically been recovered from.

Diablo Controls' unique flicker display helps insure correct operation of a channel when it is operating in the pulse mode. The channel's detect LED will turn on while the pulse is being output then display the flicker mode while the channel is still detecting the vehicle. This allows easy identification of a locked up channel operating in the pulse mode.

The DSP-20 is available in three different operating voltages and four different pin outs. This allows you to select the detector that exactly matches your installation instead of rewiring your installation to match the detector that you have.

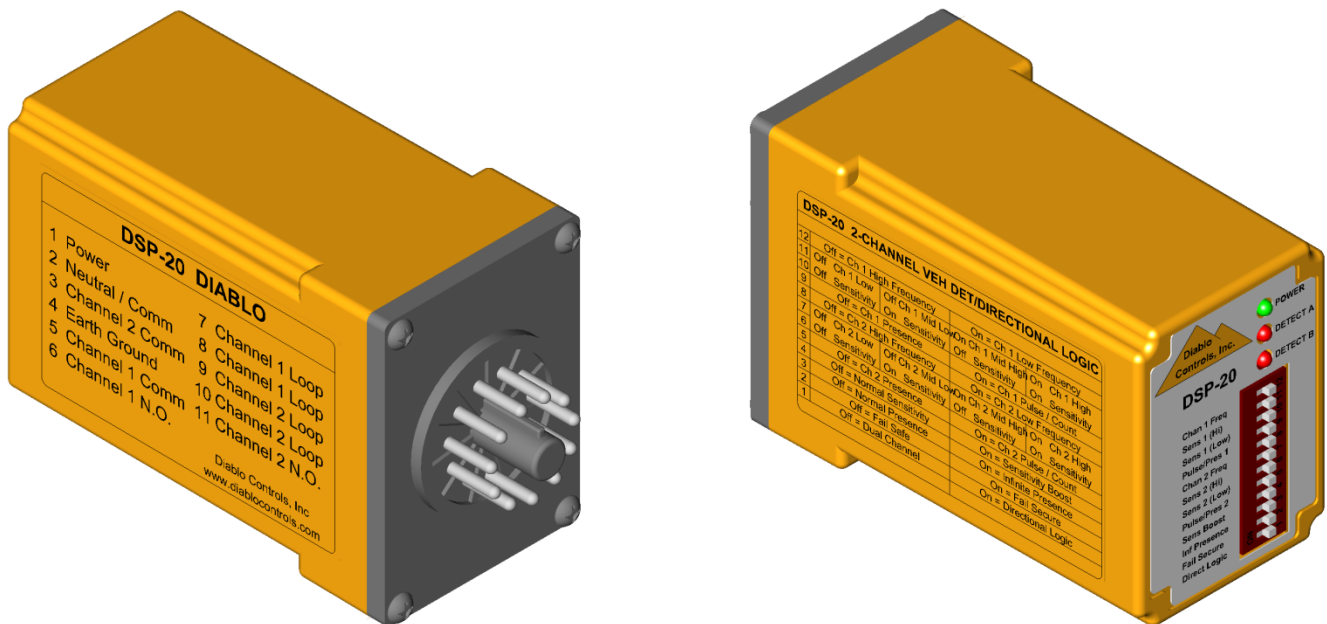

3. Technical Data

Functional Data

Sensitivity:	Four sensitivities selectable for presence or pulse modes of operation. Low .50% Δ L/L Medium Low .10% Δ L/L Medium High .05% Δ L/L High .02% Δ L/L
Frequency Settings:	There are two settings per channel. The actual loop frequency is dependent on loop circuit inductance. The detector uses a channel scanning technology to minimize channel to channel interference.
Pulse Output:	150 millisecond on period followed by a 150 millisecond off period before the next pulse can begin.
Response Time:	150 milliseconds
Vehicle Hold Time:	Approximately 1 hour for a vehicle detection of 1% Δ L/L.

Electrical Data

Loop Inductance:	20 microhenries to 1500 microhenries (including lead-in inductance)
Operating Voltages:	Three power versions 10.5 volts to 30 volts AC or DC with over voltage protection 100 volts to 135 volts AC 200 volts to 270 volts AC
Operating Current:	10-30 volts DC/AC - 65 milliamps maximum. 50 milliamps typical. 100-135 volts AC - 30 milliamps maximum. 25 milliamps typical. 200-270 volts AC - 15 milliamps maximum. 12 milliamps typical.
Output Relay Rating:	3 amps @ 125 volts

Environmental Data

Operating Temperature:	-35°F to 165°F (-37°C to 74°C)
Storage Temperature:	-40°F to 176°F (-40°C to 80°C)
Humidity:	Up to 95% relative humidity non-condensing

Mechanical Data

Mounting Position: Any

Housing Material: Lexan

Housing Size: 2.36 inches (High) x 1.75 inches (Wide) x 4.09 inches (Deep)
 59.94mm (High) x 4.45mm (Wide) x 10.39mm (Deep)

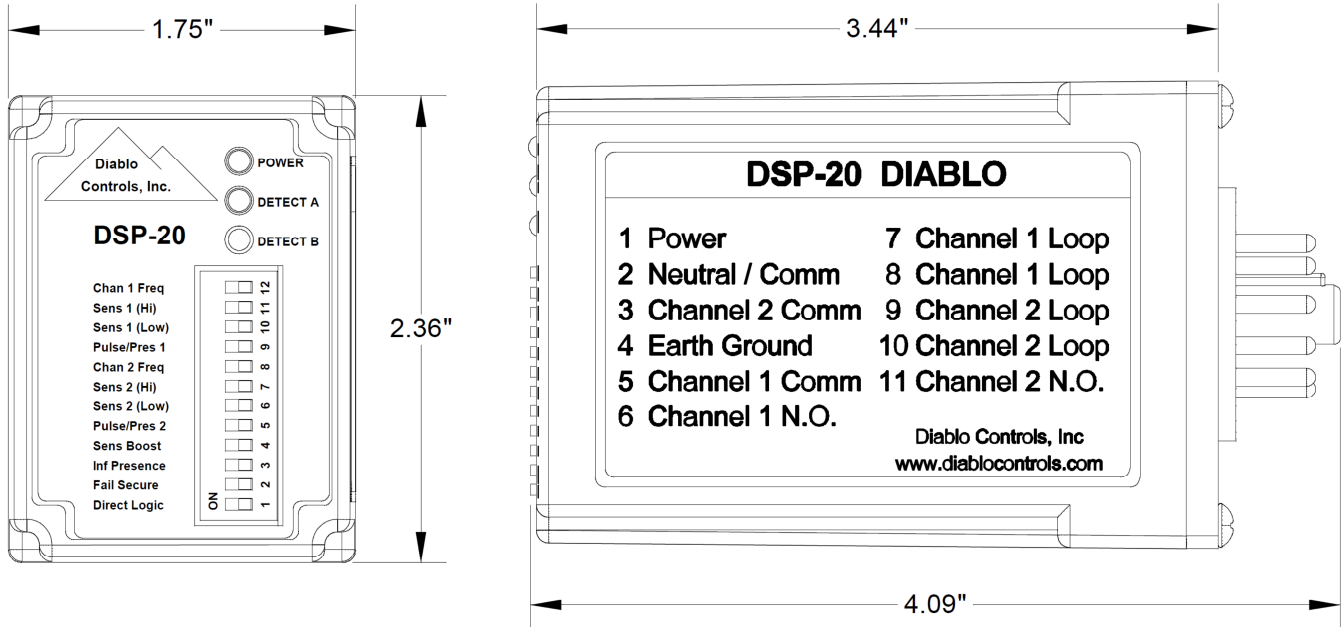

4. Features and Functions

Operating Modes

There are two selectable operating modes. Both channels of the detector will operate in the same operating mode. The two operating modes are:

Normal - Two Individual Channels with Pulse or Presence – In this operating mode the detector operates as two individual detectors. Either channel can operate in the pulse or presence mode. This matches the operation of a standard detector.

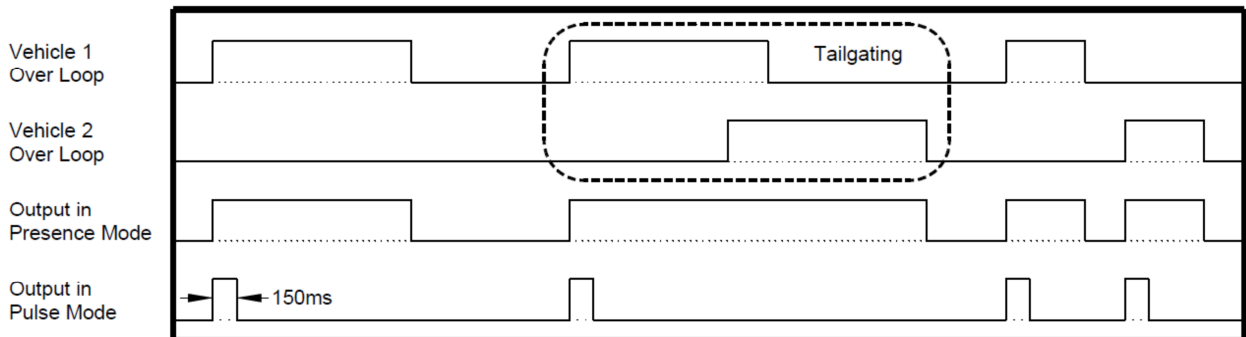

Directional Logic - Two Paired Channels with Directional Logic – In this operating mode the detector operates as two logically interconnected detectors for the purpose of determining direction of travel over two loops. The two loops are in the same travel lane and close enough together that any vehicle to be detected will be detected by the second loop before being dropped by the first. The output begins when the second loop detects the vehicle. The output can be pulse or presence for either channel.

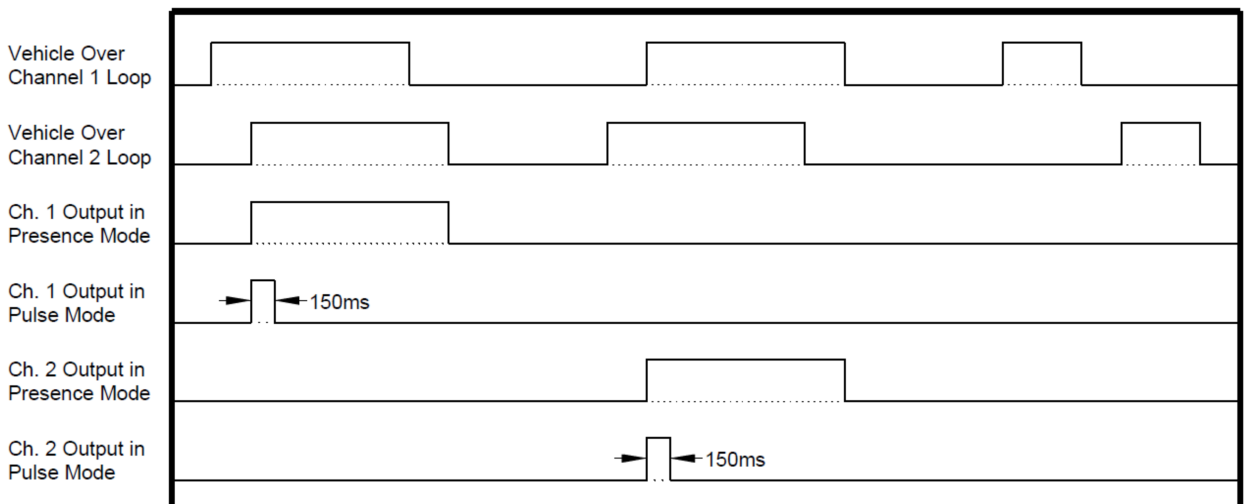

Presence Detection

The channel output will remain activated as long as a vehicle is detected over the loop. After four minutes of continuous detection, the detector will begin to slowly retune the detector channel with the goal of tuning out

the vehicle that stalled or parked on the loop. The retuning process takes about an hour to complete with a vehicle detection of 1% $\Delta L/L$. When the retuning process is complete, any loop area that vehicles can still travel over will still detect the vehicle as expected. Once the vehicle leaves, the detector will recover from the retuning process within 1 second.

This detector does not have a permanent presence or infinite presence detection mode.

This feature is activated for each channel individually.

Pulse Detection

The pulse mode used is commonly referred to as Pulse On Entry.

If the channel is the normal mode of operation (Two Individual Channels with Pulse or Presence), the channel will output a pulse when the vehicle is first detected and will not output again until the loop is no longer occupied.

If the detector is in the directional logic mode of operation (Two Paired Channels with Directional Logic), the first channel to detect the vehicle will output a pulse when the second loop detects the vehicle while the first channel is still detecting the vehicle. The detector will not output another pulse until both loops are no longer occupied.

Sensitivity

The detector has four user selectable sensitivity levels for each channel. In most situations the Medium Low or Medium High setting will work effectively.

Sensitivity Boost

The detector has a user selectable feature that increases the sensitivity of a channel after initial detection. This feature is active for both channels when selected. This feature is most often used to allow a channel to have a lower starting sensitivity and then increase it after a vehicle has been detected. This is very useful in situations where high-bed tractor-trailer vehicles will be passing over the loop. With this feature the detector may be able to detect the high-bed portion of the vehicle without having to be overly sensitive and susceptible to false detections. NOTE: If detection of high-bed tractor-trailers is required, correctly sized loops must be used.

Fail-Safe vs Fail-Secure

Here's a little note on fail-safe versus fail-secure operation. In general, a fail-safe detector will output "detect" when the loop circuit is failed. This is always useful on a safety loop to prevent accidental closure of a gate arm on a vehicle. On the free exit loop this will keep the gate open until the situation is fixed. This is useful in applications where it is important to allow traffic flow to continue. A fail-secure detector will never output "detect" when the loop circuit is failed. This will keep the gate closed. This is useful in high-security areas or installations where containment is needed.

Fail-Safe

When a channel is in the presence mode of operation and a loop failure is detected on that channel, the output for that channel will stay activated during the failure. In gate applications this feature is used to automatically open the gate if a loop fails. This feature is active for both channels when selected.

It should be noted that a power failure will always result in a fail-secure operation. Fail-safe operation is only available when a valid input voltage is applied to the detector. Channels configured for pulse output will always operate in the fail-secure mode.

Fail-Secure

When a channel is in the presence mode of operation and a loop failure is detected on that channel, the output for that channel will stay deactivated during the failure. In gate applications this feature is used to keep the gate closed if a loop fails. This feature is active for both channels when selected.

It should be noted that a power failure will always result in a fail-secure operation. Channels configured for pulse output will always operate in the fail-secure mode.

Detector Reset

When the state of any of the DIP switches 1 through 4 are changed, the detector will perform a detector wide reset which will include resets for both channels. These four switches control functions that modify the operation of the entire detector. Therefore, to insure that the changes are implemented correctly from the current operating mode, all functions of the detector are reset as if the unit had just powered up with the new settings.

All LEDs will turn off for 500 milliseconds at the start of the reset event, then on for 1 second, then off for another 500 milliseconds before returning to their normal states. The detector will not output any detections or pulses during this two second reset period. If a prior loop fault is being displayed for either channel, it will be cleared.

Channel Reset

When the state of any of the DIP switches 5 through 12 are changed, the detector will perform a channel reset for the appropriate channel. Channel 1 will be reset with changes to switches 9 through 12. Channel 2 will be reset with changes to switches 5 through 8. These switches control functions that modify the operation of a channel of the detector. Therefore, to insure that the changes are implemented correctly from the channel's current operating mode, all functions of the channel are reset as if the unit had just powered up with the new settings.

The appropriate detect LED and the power LED will turn off for 500 milliseconds at the start of the reset event, then on for 1 second, then off for another 500 milliseconds before returning to their normal states. The channel will not output any detections or pulses during this two second reset period. If a prior loop fault is being displayed for the channel, it will be cleared.

Indicators

The DSP-20 is equipped with three LED indicators: Power (Green), Detect A (Red), and Detect B (Red).

Power LED – The green power LED has four possible states:

- OFF** The voltage applied to the detector is less than the minimum display voltage of approximately 3.5 volts.
- LOW VOLTAGE** The LED will flash at a once per second rate with 500 milliseconds of on time and 500 milliseconds of off time. While in this mode, the relay outputs will not function.
- RESET** The LED will turn off for 500 milliseconds at the start of the reset event (a DIP switch change), then on for 1 second, then off for another 500 milliseconds before returning to the normal state.
- NORMAL** The LED is always on when the detector is in its normal state of operation.

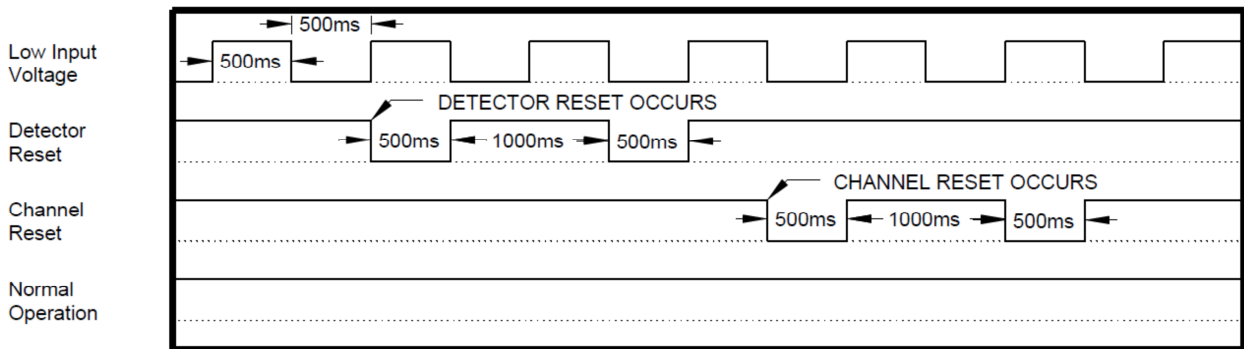

Detect A – The red Detect A LED is used to display the status of channel 1. There are several different statuses that can be displayed on this LED:

- Open Loop** When the detector senses that the loop is open or the inductance is too high, the LED will turn on for 500 milliseconds then off for 500 milliseconds for the duration of the fault.
If the fault is corrected, the LED will display the Prior Fault indication.
- Shorted Loop** When the detector senses that a loop is shorted or the inductance is too low, the LED will turn on for 100 milliseconds then off for 100 milliseconds for the duration of the fault.
If the fault is corrected, the LED will display the Prior Fault indication.
- Large Change** When the detector senses that an inductance change of more than 12.5% has occurred, the LED will turn on for 500 milliseconds, off for

100 milliseconds, on for 100 milliseconds, off for 100 milliseconds, on for 100 milliseconds, off for 100 milliseconds and then repeat the entire sequence for the duration of the fault.

If the fault is corrected, the LED will display the Prior Fault indication.

Prior Fault

The detector is equipped with the ability to remember prior faults that have occurred since the last power interruption or reset (changing a DIP switch). The LED will turn on for 100 milliseconds, off for 100 milliseconds, on for 100 milliseconds, off for 1700 milliseconds and then repeat the sequence until power is cycled, the detector reset, or the channel reset.

The Prior Fault indication is only displayed when the loop is unoccupied or when the channel is in the pulse mode of operation and currently is occupied.

Reset

When the detector or the channel is reset (a reset occurs automatically at power up), the LED will turn off for 500 milliseconds, on for 1000 milliseconds, off for 500 milliseconds and then resume its normal display.

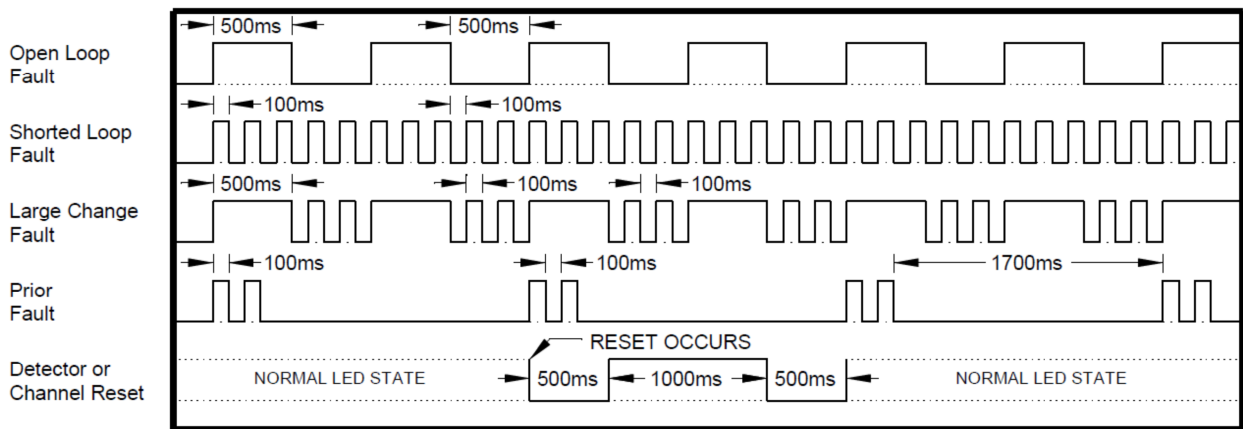

Occupancy

When the channel is operating in the pulse mode and currently is occupied the LED will be turned on to a dimmer level than normal and the LED will be flashed at a very fast rate that will make it look like it is flickering.

This display is meant to be easily distinguishable from the normal on display. With this additional display mode, the pulse mode of operation can easily be monitored for correct operation.

A look at the following figure will show how this occupancy indication is used to provide additional information in each of the possible modes of

operation for the channel. In the figure the occupancy display is shown as the gray shaded area.

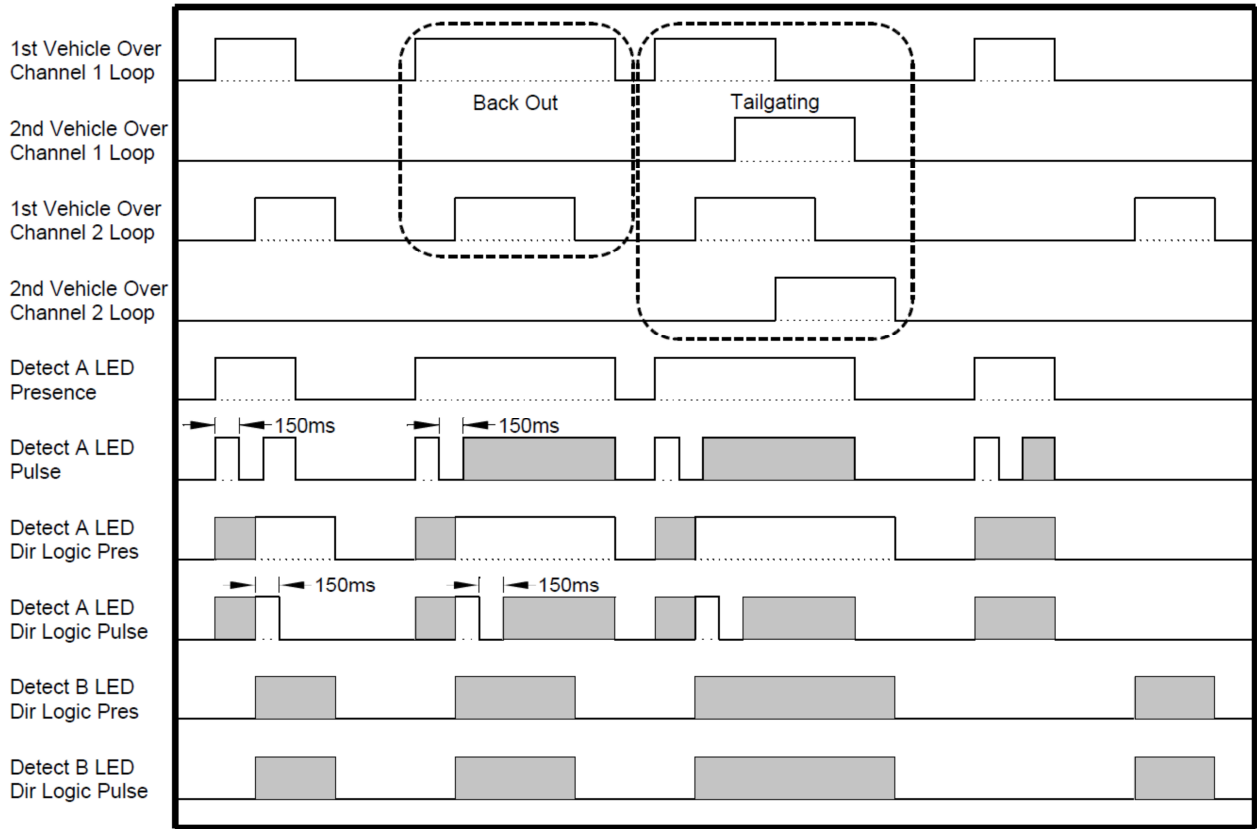

5. Installation

Detector Installation

Location: The detector should be installed in a weatherproof location that is near the loop. Ideally, a technician should be able to see the loop and the detector at the same time.

Mounting: The detector will function when mounted in any orientation. If using a relay socket, it is best to mount the detector such that the front panel will be easily accessible for configuration and troubleshooting. If using a detector harness, be sure to leave enough of the wiring harness to allow the technician to easily work with the detector.

Wiring: There are several possible pin-outs for the detector. The detector will come with a side label identifying how that particular detector is pinned out. Wire nuts can be used for most connections to the wires in a detector wiring harness. However, wire nuts should never be used at any point in the loop circuit itself. All loop connections should be crimped or screw terminals at a minimum and soldered for best long term reliability.

Special attention should be paid to insure that the loop wires remain tightly twisted together. An air gap between the two wires for a loop may cause the detector channel to lock up if the wires are disturbed.

Loop Installation

The reliability and overall performance of the detector are greatly dependent on the loop itself. Several factors go into a good loop installation: type of wire used, loop configuration, and installation practices.

Type of Wire Used: The wire used for wiring the loop should have a jacket of cross-linked polyethylene. This would be a wire with an XLP jacket such as XHHW. THHN or similar wire types should never be used for loop wire.

The gauge of the wire to use depends on two factors: Distance in cable feet from the loop to the detector and stresses the wire may see. The gauge of the wire can be 20AWG as long as the detector is within 50 feet of the loop in cable distance. For 50 to 100 feet, use at least 18AWG wire. At greater than 100 feet, use a 16AWG wire at a minimum. If the loop is installed in asphalt and there will be heavy vehicles or stopping and starting vehicles in the loop area, a 14AWG or 12AWG should be used to provide additional strength to the loop. This helps increase the life of the loop in areas where the asphalt may slowly move and/or deform due to wear.

Loop Configuration: The size and shape of the loop will determine what type of vehicles it can reliably detect. One common rule is that the useable field height of a loop is $2/3$ the shortest leg of the loop. So if you plan on using a 2.5' x 6' loop, the expected useable detection height would be 20" (The shortest leg is 2.5' or 30", $30" \times 2 = 60"$, $60" / 3 = 20"$). If the installation requires the detection of motorcycles as well as vehicles, the loop should go to within one foot of the curb or road way edge, whichever is present. If only motor vehicle detection is required, within three feet of the curb or road way edge is all that is required.

The number of turns to use in a loop is dependent on the size of the loop, the amount of metal (rebar, cables, etc.), and distance from the loop to the detector. Rather than dive into all of the calculations to arrive at a

value, we will just use safe values. You can almost never have too many turns in a loop, only too few. For a loop size of 2' x 6', four turns will be sufficient unless there is metal in the loop area. In that case add at least one turn, and two if possible. As the loop size reaches 6' x 6', four turns will work for all most all installations. If you are unsure about your particular installation, call tech support for guidance.

The directional logic mode is optimized to use two loops that are 6 feet to 7 feet apart (approximately 2 meters).

Installation Practices: Permanent loops should be installed into the road surface by cutting slots into the road surface using a saw with an appropriate cutting disk for the road surface.

The slot cut should be wide enough that the wire being used will easily fit into the slot. This is needed so that the loop sealant used can fully encapsulate the wire. When the wire fits tightly in the slot, the sealant may not be able to get below the wire, leaving air pockets in the saw slot. If water finds its way in to these air pockets, over time, freeze thaw cycles can slowly jack the loop out of the saw slot causing loop failure.

The saw slot should be deep enough that the loop wire will have a minimum of ½" of sealant over the top wire in the slot. More is better. Going too deep with the saw cut is also a concern. Deep cuts in a road surface may impact the structural strength of the roadway, especially if any reinforcement material is cut. Using a smaller gauge of wire will allow for shallower saw cuts.

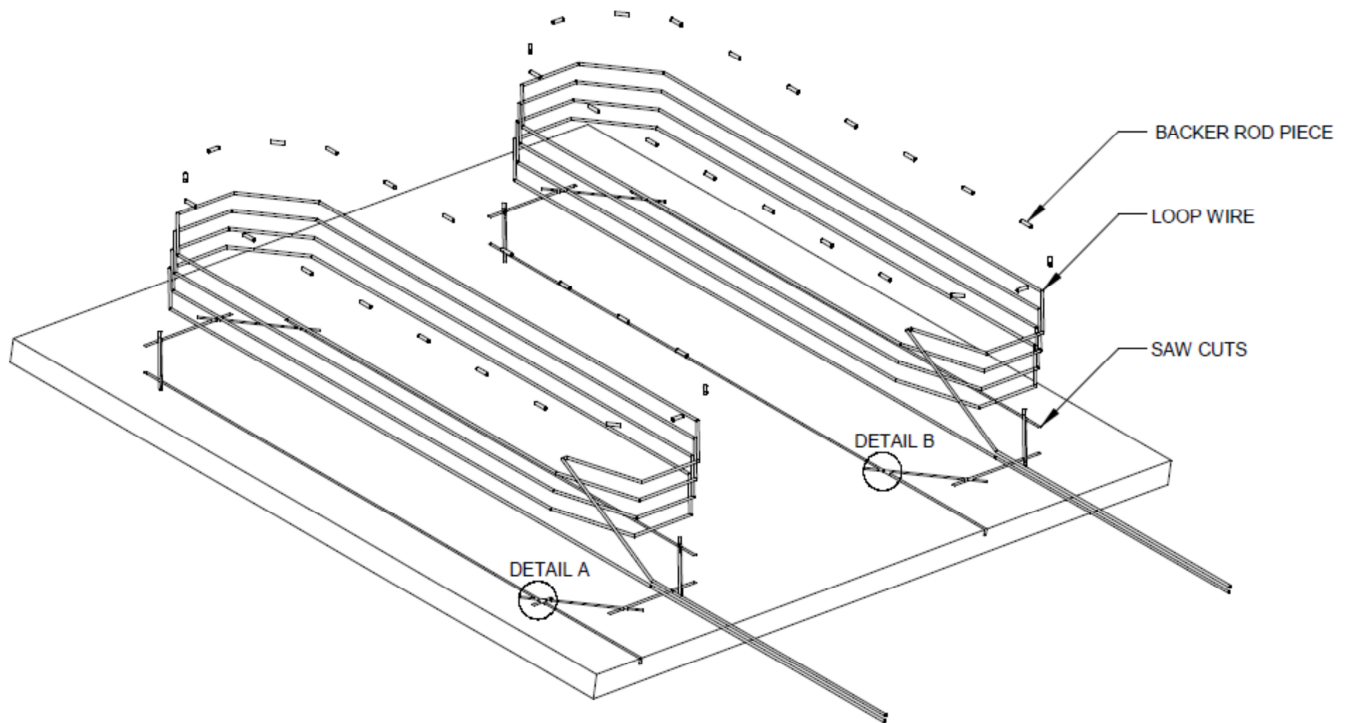

The corners of the loop should be crosscut at a 45° to help prevent damage to the wire insulation during installation and temperature cycling. The angled cuts should be at least 9" back from where the corner would be. The saw cuts should not go any further than necessary to insure that the saw slots are at full depth where they meet.

Special consideration should be given to where the home run saw cut meets the loop saw cuts. Here either an additional saw cut should be made as shown in Detail A or the inside of the sharp corner should be removed with a chisel as shown in Detail B.

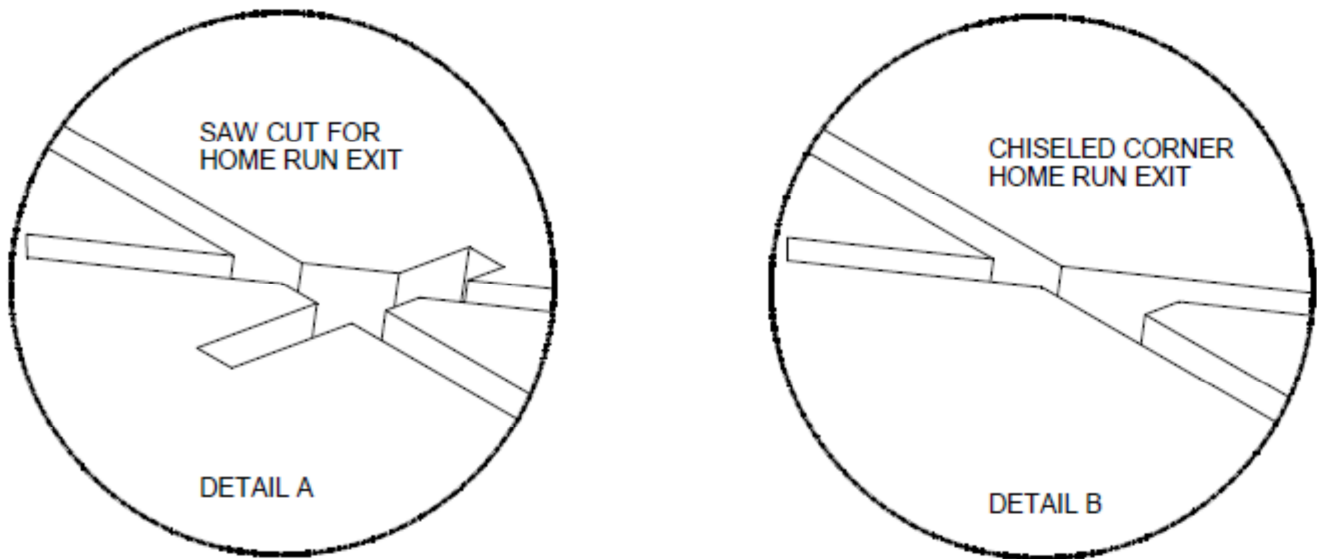

Once the saw slot has been cut, the slot should be cleaned of all loose material. High pressure air should be directed in to the saw slot to remove all debris. This will also help remove dust from the saw cutting operation from the sides of the saw slot. This will allow better adhesion of the loop sealant to the saw slot.

The loop wire should be installed as a continuous piece of wire from the detector to the loop, all of the turns in the loop, and back to the detector. Remember to make allowance for shrinkage in the wire length when the portion of the wire not in the roadway surface is twisted. The twisting is important for dealing with electrical noise. A splice of the loop wire should never be made in the roadway. If the loop wire needs to be spliced to another cable to get to the detector, the splice should be done in a junction box and the connections should be soldered and weatherproofed. Wire nuts should never be used at any point in the loop circuit.

In order to keep the loop wire at the bottom of the saw slot, 1" to 2" pieces of backer rod should be placed in the saw slot every 1 to 2 feet. The backer rod should be sized such that it fits snugly in the saw slot. Use a blunt object (not a screwdriver) to press the backer rod pieces down into the saw slot as far as they will go. Keeping the loop wire at the bottom of the saw slot allows the loop sealant to provide the maximum amount of protection possible from foreign object penetration. Never use a continuous piece of backer rod over the loop, as this would prevent the loop sealant from encapsulating the loop wire.

The loop sealant used should be appropriate for the roadway surface that was cut. Generally, epoxy or polyester based sealants are used for concrete surfaces and polyester or urethane based sealants are used for asphalt surfaces. However these are not hard guidelines and specific circumstances will determine which type of sealant should be used.

Once the loop wire leaves the saw slot it should be twisted at least three times per foot. More is better. The twists should be kept tight to be most effective in reducing the effects of electrical interference.

6. Configuration

DIP Switches

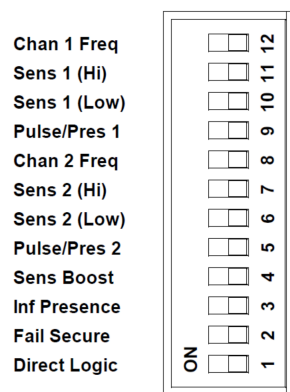

All of the controls for adjusting the configuration of the DSP-20 detector are located on the front panel 12-position DIP switch. There are no internal DIP switches or jumpers to configure.

When a DIP switch is moved to the left position it is in the ON condition. The right position is OFF.

Some of the settings used paired switches. So the user must be sure to set both of the switches in the correct position to get the desired operation.

Channel 1 Frequency (Switch 12) – This switch is used to adjust the oscillating frequency of the loop connected to channel 1. This should be used to eliminate interference from other loops that may be in the same area, but connected to a different detector. Loops connected to the same DSP-20 detector will not interfere with each other by design.

OFF = the highest loop frequency selection possible. ON = the lowest loop frequency selection possible.

Channel 1 Sensitivity (Switches 10 & 11) – These two switches select the sensitivity for Channel 1 when it is operating in a presence or pulse mode. For most installations the medium high or medium low setting will work. If motorcycle detection is required, you may need to use the medium high or high setting.

Switch 11	Switch 10	Setting	$\Delta L/L$
OFF	OFF	Low Sensitivity	.50%
OFF	ON	Medium Low Sensitivity	.10%
ON	OFF	Medium High Sensitivity	.05%
ON	ON	High Sensitivity	.02%

Channel 1 Pulse / Presence (Switch 9) – This switch determines if Channel 1 operates using presence detection or pulse detection.

OFF = the channel operates in presence mode. ON = the channel operates in pulse mode.

Channel 2 Frequency (Switch 8) – This switch is used to adjust the oscillating frequency of the loop connected to channel 2. This should be used to eliminate interference from other loops that may be in the same area, but connected to a different detector. Loops connected to the same DSP-20 detector will not interfere with each other by design.

OFF = the highest loop frequency selection possible. ON = the lowest loop frequency selection possible.

Channel 2 Sensitivity (Switches 6 & 7) – These two switches select the sensitivity for Channel 2 when it is operating in a presence or pulse mode. For most installations the medium high or medium low setting will work. If motorcycle detection is required, you may need to use the medium high or high setting.

Switch 7	Switch 6	Setting	$\Delta L/L$
OFF	OFF	Low Sensitivity	.50%
OFF	ON	Medium Low Sensitivity	.10%
ON	OFF	Medium High Sensitivity	.05%
ON	ON	High Sensitivity	.02%

Channel 2 Pulse / Presence (Switch 5) – This switch determines if Channel 2 operates using presence detection or pulse detection.

OFF = the channel operates in presence mode. ON = the channel operates in pulse mode.

Sensitivity Boost (Switch 4) – This switch determines if the sensitivity of a channel increases after initial detection. This feature is most often used when high-bed trucks need to be detected, but noise, interference, or adjacent lane detection won't allow the detector to be operated at a higher sensitivity without false calls. This feature is activated for both channels at the same time. This feature has no effect on channels in pulse mode or already at high sensitivity.

OFF = in presence mode, the channel sensitivity is used for the entire detection. ON = in the presence mode, the channel sensitivity is increased up to four times after the initial vehicle detection.

Extended Presence (Switch 3) – This switch determines if channels operating in the presence mode will be able to hold a detection for an extended period of time. In normal presence, the detection of a typical vehicle can be held for about an hour. In extended presence, the same vehicle would be held for about 18 hours. This feature is activated for both channels at the same time.

Fail Type (Switch 2) – This switch determines if the relay outputs operate in a fail-safe or fail-secure mode of operation.

During fail-safe operation, when a channel is in the presence mode of operation and a loop failure is detected on that channel, the output for that channel will stay activated during the failure. In gate applications this feature is used to automatically open the gate if a loop fails.

During fail-secure operation, when a channel is in the presence mode of operation and a loop failure is detected on that channel, the output for that channel will stay deactivated during the failure. In gate applications this feature is used to keep the gate closed if a loop fails.

This feature is active for both channels when selected. It should be noted that a power failure will always result in a fail-secure operation. Fail-safe operation is only available when a valid input voltage is applied to the detector. Channels configured for pulse output will always operate in the fail-secure mode.

OFF = the fail-safe mode of operation is selected. ON = the fail-secure mode of operation is selected.

Directional Logic (Switch 1) – This switch determines if the detector will operate in the directional logic mode or the normal mode of operation. See Section 4 – Features and Functions for a detailed description of the two operating modes.

OFF = two individual channels with pulse or presence. ON = two paired channels with directional logic.

Wiring

The wiring for each loop circuit must be kept twisted to provide the most reliable operation. Wire nuts should never be used for any connection in the loop circuit.

The last set of characters in the model number designate the operating voltage for the detector. There are three possible types:

- LV 10 to 30 volts, Ac or DC (Low Voltage)
- 117 100 to 135 volts AC
- 230 200 to 270 volts AC

There are four different wiring configurations (pin-outs) to facilitate easy replacement of any existing detectors. See the tables that follow to determine the correct model for your installation.

DSP-20-LV, DSP-20-117, and DSP-20-230 or
DSP-20-A-LV, DSP-20-A-117, and DSP-20-A-230

Pin	Function
1	DC + or AC Line
2	DC Common or AC Neutral
3	Channel 2 Relay Common
4	Earth Ground
5	Channel 1 Relay Common
6	Channel 1 Relay Normally Open
7	Channel 1 Loop
8	Channel 1 Loop
9	Channel 2 Loop
10	Channel 2 Loop
11	Channel 2 Relay Normally Open

DSP-20-R-LV, DSP-20-R-117, and DSP-20-R-230

Pin	Function
1	DC + or AC Line
2	DC Common or AC Neutral
3	Channel 2 Relay Normally Open
4	No Connection
5	Channel 1 Relay Common
6	Channel 1 Relay Normally Open
7	Channel 1 Loop
8	Channel 1 Loop
9	Channel 2 Relay Common
10	Channel 2 Loop
11	Channel 2 Loop

DSP-20-B-LV, DSP-20-B-117, and DSP-20-B-230

Pin	Function
1	DC + or AC Line
2	DC Common or AC Neutral
3	Channel 2 Relay Normally Open
4	No Connection
5	Channel 1 Relay Common
6	Channel 1 Relay Normally Open
7	Channel 1 Loop
8	Channel 1 Loop
9	Channel 2 Relay Common
10	Channel 2 Loop
11	Channel 2 Loop

DSP-20-N-LV, DSP-20-N-117, and DSP-20-N-230

Pin	Function
1	DC + or AC Line
2	DC Common or AC Neutral
3	Channel 2 Relay Normally Open
4	No Connection
5	Channel 1 Relay Common
6	Channel 1 Relay Normally Open
7	Channel 1 Loop
8	Channel 1 Loop
9	Channel 2 Relay Common
10	Channel 2 Loop
11	Channel 2 Loop

7. Troubleshooting

No Power LED

The first step is to insure that the correct model of the detector is being used for the installation. Insure that the correct wiring configuration (pin-out) and the correct voltage are being used.

Use a meter to measure the voltage applied to the detector. For the LV version the voltage must be above 10V AC or DC. For the 117 version the voltage must be above 100V AC. For the 230 version the voltage must be above 200V AC.

If the correct voltage is applied and the power LED is not on, replace the detector.

Flashing Power LED

The first step is to insure that the correct model of the detector is being used for the installation. Insure that the correct wiring configuration (pin-out) and the correct voltage are being used.

Use a meter to measure the voltage applied to the detector. For the LV version the voltage must be above 10V AC or DC. For the 117 version the voltage must be above 100V AC. For the 230 version the voltage must be above 200V AC.

If the correct voltage is applied and the power LED is still flashing, replace the detector.

A Channel LED Flashes Slowly (1 Hz)

This flash rate indicates that the channel has an open loop, a high resistance in the loop circuit, or excessive inductance.

The first step is to confirm that the channel has a loop connected to it and the loop is connected to the correct pins (see the wiring configuration for the model being used). In some situations only one of the channels of the detector will be used. In this case, the slow flashing indication is normal. To make the flashing go away when the channel is not being used, obtain an inductor with a value between 50 and 500 microhenries and connect it to the loop inputs (Mouser Electronics Part Number: 542-8250-101K-RC or equivalent).

If a loop is connected to the correct pins of the detector, disconnect the loop and using an ohmmeter, check the resistance of the loop circuit. If the resistance is above 5 ohms there is a bad connection or the wire has been damaged. The resistance will typically be 1.5 ohms or less.

If the resistance is below 5 ohms, the loop inductance should be checked. This is done using an inductance meter. The inductance of the loop should be less than 1500 microhenries. It is very unusual to have a loop with an inductance value this high, but it is possible with very large loops and many turns. If the loop inductance value is above 1500 microhenries, the loop will have to be replaced with a loop with less inductance. Contact technical support for help with very large loops.

If you do not have a meter capable of measuring resistance and inductance, you can skip to this step. Swap the loops between a working channel and a failing channel. If the problem follows the loop the loop is the problem. If it stays in the same channel, replace the detector.

A Channel LED Flashes Quickly (5 Hz)

This flash rate indicates that the channel has a shorted loop, a low resistance across the loop circuit, or insufficient inductance.

The first step is to confirm that the loop is connected to the correct pins (see the wiring configuration for the model being used). If the wiring is correct, the next step is to confirm that the detector channel is working correctly. Disconnect one of the loop wires for the channel. The LED should begin flashing at a much slower rate (½ second on, ½ second off). If it does not change its flashing rate, change the detector.

If a loop is connected to the correct pins of the detector, disconnect the loop and using an ohmmeter, check the resistance of the loop circuit. If the resistance is below .2 ohms there is a short in the loop circuit. The resistance will typically be 0.5 ohms to 1.5 ohms.

If the resistance is above .2 ohms, the loop inductance should be checked. This is done using an inductance meter. The inductance of the loop should be more than 20 microhenries. If the loop inductance is less than 20 microhenries, the loop was probably not wound correctly and only has one turn in it. In this case the loop must be replaced. Other possibilities include a foreign object embedded in the saw cut and shorting some or all of the wires, or failed wire insulation due to the wire being exposed or the wrong type of wire being used. Very small loops may also have a low inductance value if sufficient turns were not added. Contact technical support for help with very small loops.

If you do not have a meter capable of measuring resistance and inductance, you can skip to this step. Swap the loops between a working channel and a failing channel. If the problem follows the loop the loop is the problem. If it stays in the same channel, replace the detector.

A Channel LED Shows Two Quick Flashes Once Every Two Seconds

This flash rate indicates that the channel has had a failure of some type, but is currently working correctly.

Intermittent failures are usually open loop failures. Any splices in the loop wire should be redone. If there are any wire nuts used in the loop circuit, remove them and replace with a crimp connection or preferably, a soldered connection. The open loop fault could also be a fatigued point in the loop wire. This can occur at locations where the loop wires cross an expansion joint in the road surface. Any place where the loop wires must move, even if only a very tiny amount, can cause wire fatigue. The actual failure point may be very difficult to find. Often the loop must just be replaced if the issue persists but cannot be found.

It is possible for the intermittent failure to be a shorted loop fault. One possible source of this type of fault is a foreign object being embedded in the loop saw cut and damaging the wire. Another is that the loop wire has been damaged where it enters or exits a conduit or junction box, or that a conduit that the loop wire is in has been damaged (crushed, kinked, bent, cut, etc.).

A Channel LED Intermittently Comes On / Stays On Without a Vehicle Present

This type of symptom is usually caused by one of three issues: physical issues with the loop, electrical interference, moving objects in proximity to the loop.

Physical Issues with the Loop – There are many ways in which a loop installation can go bad.

The insulation of the loop wire can fail. This can be due to the loop wire being exposed in the saw lot, damage to the wire insulation during loop installation, physical stressing of the wire due to movement (crossing of expansion joints or asphalt that has slowly moved or deformed), wires moving in the saw slot due to poor loop sealant encapsulation, foreign objects embedded in the saw slot, and poor electrical connections in the loop circuit.

The best way to check for any of these issues is to use a megohmmeter (commonly referred to as a megger). Disconnect the loop wires in question from the vehicle detector and any other electronic equipment. Connect one lead of the megger to one end of the loop wire and the other lead to earth ground. Measure the resistance. For accurate measurements the ground and the loop should be wet or at least damp (use a hose or a bucket of water if needed to get the area wet). The reading should be at least 100 megohms. If it is less than 50 megohms the insulation is compromised and the loop circuit has to be replaced. Between 50 and 100 megohms, the loop may or may not work properly and reliably.

Electrical Interference – There are several possible sources of electrical interference: loop cross-talk, power lines, electric motors, and insufficient twisting of the loop wires, just to name a few.

Other loops in the area that are connected to a different detector are prone to cross-talk (when the magnetic fields from different loops interfere with each other). Adjusting the loop frequency of one or both of the loops in the same area will usually allow you to find a setting that both loops will work reliably with.

Anything that uses electricity is a possible source for electrical interference depending on its proximity to the loop and the amount of energy being used. If you believe the loop is experiencing electrical interference, turn off the device believed to be the source of the interference and see if the problem goes away. Sometimes this is not possible and more technical means are needed to help identify the source. Call Technical Support in this case.

If the electrical interference is occurring in the wire from the loop to the detector, additional twisting should help mitigate the issue.

Moving Objects in Proximity to the Loop – Objects that can move and are metallic or somehow electrically conductive, may cause detection issues.

A common issue is movement of a slide gate or gate arm in close proximity to a loop. The best solution would be to move the detection area further away from the moving gate. We recommend that all loops should be at least 4 feet from a slide gate. Try lowering the sensitivity one level so that the desired vehicles are still detected, but not the moving gate. NOTE: Do not lower the sensitivity too much or vehicles will no longer be detected.

Another possibility is metal objects in close proximity to the loop. Utility manhole covers are objects that may move slightly when vehicle tires drive over them, especially if the vehicle turns while a tire is on the cover. Most manhole covers can be bolted in place. Contact the owner of the manhole to see what can be done to mitigate the cover movement.

A Channel LED Will Not Come On With a Vehicle Present

The first thing to do is verify that the LED in question is still working. This is accomplished by a quick lamp test. Reset the detector by temporarily changing DIP switch 1, the mode switch. All three LEDs should turn off and turn on for one second. If the red channel LED does not illuminate, then replace the detector.

If the red LED illuminates, then perhaps the sensitivity setting is too low. There are many variables in determining overall sensitivity: loop size, number of turns, loop lead-in, percent coverage, etc. In most cases, medium high or medium low sensitivity is the correct setting. However, to compensate for some unusual loop geometries, this setting may be inadequate. Adjust the sensitivity by one level higher and recheck the detector for proper detection.

If the channel sensitivity is set to high and the red LED still does not come on, swap the loops between a working channel and the channel with the issue. If the problem follows the loop, the loop is the problem. If it stays in the same channel, replace the detector.