

Transporter Mobile DVR

# User Manual



---

# Preface

We welcome you as a new user of the world's best digital video recorder (DVR), and the leading Digital Video Surveillance System. For effective usage, please read this manual carefully. For future reference, please keep this manual close-at-hand.

## Copyright/Authentication/Trademark/Limited Warranty

### Copyright

This manual is produced under copyright law. None of its contents may be copied or duplicated without prior approval.

Copyright 2009~

### Authentication

CE, FCC, KCC

### Trademark

Ethernet™ is the trademark of Xerox Corporation.

Microsoft™, MS-DOS™, Windows™, and Windows NT™ are the trademarks of Microsoft Corporation, used in the United States and elsewhere.

### Limited Warranty





- The manufacturer, importer, and agent shall not be responsible for accidental damage (including injury) and other damages caused by inappropriate use or operation of this product.
- The information in this manual is prepared based on the current specifications for the product. The manufacturer is currently adding new functions and will continue to upgrade the product with new technology. All specifications may be changed without notice to individual users.

## Cautions

To operate the product appropriately, we strongly recommend that users read all safety cautions carefully before operating the product.

Since the indicated cautions contain critical safety information, they must be fully complied with.

The cautions are categorized into the following groups: Danger, Warning, Caution, and Important.

 Danger	Risk of death or serious injury. This is the highest priority danger warning.
 Warning	Risk of serious or lesser degree of injury. May also cause damage to the product or to property.
 Caution	Risk of minor injury or damage.
 Important	Requirements or limitations regarding operation. Users are recommended to read the relevant details carefully to operate the product properly and without harm.

The above cautions indicate the degree of damage that may occur due to inappropriate use of the system.



Risk of death or serious injury.  
This is the highest priority danger warning.

- RISK OF EXPLOSION IF BATTERY IS REPLACED BY INCORRECT TYPE. DISPOSE OF USED BATTERY ACCORDING TO THE INSTRUCTIONS.
- THIS EQUIPMENT IS FOR INDOOR-USE, AND ALL THE COMMUNICATION WIRINGS ARE LIMITED TO INSIDE OF THE BUILDING.
- Please connect the power cord only to the type of AC outlet indicated in the manual or product specification. If connected to other types of power outlet, fire and electric shock may result.
- Do not expose the product to moisture and dampness. Doing so may result in fire and electric shock.
- Do not place heavy objects on top of the power cord. Damage to the power cord may result in fire and electric shock.
- Do not place containers with liquid or small metal objects on top of the product. Liquid or small metal objects that get inside the unit may lead to fire and electric shock.
- Do not score, bend, twist, pull, or heat the power cord. Damage to the power cord may lead to fire and electric shock.
- Do not remove the top casing of the product. Doing so may result in electric shock. If internal examination and maintenance are deemed necessary, contact the authorized system vendors or installers.
- Do not modify the product in any way. Doing so may lead to fire and electric shock.
- In case of lightning, immediately turn off the power switch and remove the power cord from the power outlet. Failure to do so may result in fire and electric shock.
- Please use the power cord supplied with the product. Use of other power cords may result in fire and electric shock.
- In case of smoke, smell, or noise, immediately turn off the power switch and remove the power cord from the power outlet. Continued operation of the product may result in fire and electric shock. Request a maintenance service from the authorized system vendors or installers.
- If the product is dropped or damaged, turn off the power switch and remove the power cord from the power outlet. Continued operation of the product may result in fire and electric shock. Users should request a maintenance service from the authorized system vendors or installers.
- Do not touch the product with wet hands. Doing so may result in electric shock.



Risk of serious or lesser degree of injury.  
May also cause damage to the product or to property.

- Do not leave the power cord or other cables in passageways. Passerbys may trip and fall.
- Avoid contact with water or beverages. Contact with water or beverages may result in damages that cannot be repaired.
- In case of lightning, immediately turn off the power switch and remove the power cord from the power outlet. The product may otherwise be damaged.
- Excessive current from the product and the camera may result in an electric shock. Connect the power cord to an external device only when the products themselves are disconnected from their power supply.



Risk of minor injury or damage.

---

- If a foreign substance is stuck to the product, use a soft cloth or tissue to remove it. Do not use chemical agents (thinner, solvent, etc) to remove the substance.
- Do not operate or store the product in the following places:
  - An area that is either too cold or too hot
  - An area of high humidity or in front of an air-conditioner or places subject to sudden temperature changes
  - An area where there is excessive dust
  - Areas where heat from the product cannot be emitted through both of the product's side ventilation openings
- Do not place credit cards, telephone cards, bank account books, tickets, and other objects with magnetic properties near the product.
- Static electricity may cause damage to the internal parts of the product. Please remove static electricity from your body before touching the rear panel and internal electronic parts of the product.
- If this product is damaged beyond repair or reaches its maximum service life, dispose of it in compliance with local laws and regulations regarding the disposal of lead and plastic waste.



Requirements or limitations regarding operation. Users are recommended to read the relevant details carefully to operate the product properly and without harm.

---

- The product may not work properly if the power source is unstable and/or if electric shock occurs. Make sure the correct rated power is available.
- The product is designed to be proof against electric power failures; however, damage may occur as a result of power failure. Current data may be damaged or data might not be recorded. Make sure to use an Uninterruptible Power Supply (UPS).
- Since the product is designed to record video data on a hard disk, an error in the hard disk or other miscellaneous errors might prevent the product from recording properly. Periodic maintenance is required for proper operation of the product.
- The product is designed for users to configure their own interface. However, a user configuration error could lead to operation malfunction. This product should be setup by certified installers only.
- Since the product is connected and tightly coupled to exterior accessories (camera, sensor, LAN, Hard Disk, etc), there is a risk of malfunction from external causes. Ensure periodic maintenance by certified installers.
- For installation, use the rack mounting handle provided with the product.
- In this product, 1 Kbyte equals 1,024 bytes; 1 Mbyte equals 1,024,000 bytes; and 1 Gbyte equals 1,024,000,000 bytes.

---

# Contents

<b>Preface</b> .....	<b>1</b>
Copyright/Authentication/Trademark/Limited Warranty .....	1
Cautions .....	1
<b>Contents</b> .....	<b>4</b>
<b>Chapter 1. Introduction</b> .....	<b>6</b>
<b>1. The System</b> .....	<b>6</b>
<b>2. General Features</b> .....	<b>6</b>
<b>3. Specification</b> .....	<b>7</b>
<b>Chapter 2. System Installation</b> .....	<b>8</b>
<b>1. Package Contents</b> .....	<b>8</b>
<b>2. Installation</b> .....	<b>9</b>
2-1. Bracket Disassembly .....	9
2-2. Unit Installation .....	10
2-3. Connection Devices .....	11
<b>3. Cautions</b> .....	<b>14</b>
<b>Chapter 3. Using DVR</b> .....	<b>15</b>
<b>1. Basic Operation</b> .....	<b>15</b>
1-1. Front Panel & IR Remote Controller .....	15
1-2. Turning on the System .....	17
1-3. Menu Bar .....	17
1-4. Display Icons .....	18
1-5. User or Admin Login .....	18
1-6. The Main Menu .....	19
1-7. Contextual Menu .....	20
<b>2. DVR Configuration</b> .....	<b>21</b>
2-1. SYSTEM .....	21
2-1-1. MENU > SYSTEM > Information .....	21
2-1-2. MENU > SYSTEM > Date & Time .....	23
2-1-3. MENU > SYSTEM > User .....	24
2-1-4. MENU > SYSTEM > Quick Setup .....	25
2-1-5. MENU > SYSTEM > System Log .....	25
2-2. DEVICE .....	26
2-2-1. MENU > DEVICE > Camera .....	26
2-2-2. MENU > DEVICE > Audio .....	27
2-2-3. MENU > DEVICE > Alarm .....	27
2-2-4. MENU > DEVICE > Keyboard .....	28
2-2-5. MENU > DEVICE > RS232 & RS485 .....	28
2-3. DISPLAY .....	29
2-3-1. MENU > DISPLAY > Display .....	29
2-3-2. MENU > DISPLAY > Monitoring .....	29
2-4. RECORD .....	30
2-4-1. MENU > RECORD > Storage .....	30
2-4-2. MENU > RECORD > Record .....	30
2-4-3. MENU > RECORD > Record Tools .....	32
2-5. NETWORK .....	33
2-5-1. MENU > NETWORK > Address .....	33
2-5-2. MENU > NETWORK > DDNS .....	33
2-5-3. MENU > NETWORK > Notification .....	34

2-5-4. MENU > NETWORK > Transmission .....	35
2-6. EVENT .....	36
2-6-1. MENU > EVENT > Sensor .....	36
2-6-2. MENU > EVENT > Motion .....	37
2-6-3. MENU > EVENT > Video Loss .....	39
2-6-4. MENU > EVENT > Text-In .....	40
2-6-5. MENU > EVENT > System .....	42
2-6-6. MENU > EVENT > G-Sensor .....	43
<b>3. Playback .....</b>	<b>44</b>
3-1. Go to Time.....	45
3-2. Calendar Search.....	45
3-3. Event Search.....	46
3-4. Text-In Search.....	46
3-5. Backup Data Playback .....	47
3-6. Playback Control .....	47
<b>4. Backup.....</b>	<b>48</b>
4-1. Backup .....	48
4-2. Instant Backup.....	49
4-3. Clip Maker.....	49
<b>Chapter 4. Transporter Viewer .....</b>	<b>50</b>
<b>1. Using Transporter Viewer.....</b>	<b>50</b>
1-1. Starting the Software.....	50
1-2. Site Set Up .....	52
1-3. Favorite Set Up .....	54
1-3. Site List Panel .....	55
1-4. Tool Panel .....	56
1-4-1. DVR .....	56
1-4-2. PTZ.....	56
1-4-3. TEXT-IN .....	57
1-4-4. GPS.....	57
<b>2. Remote Playback.....</b>	<b>58</b>
2-1. Calendar Search.....	58
2-2. Event Search.....	59
3-3. Text-In Search.....	60
3-4. Saving the Recorded Data.....	61
3-5. Play Backup Data .....	62
3-6. Play Independent HDD Data on PC.....	63
<b>4. Setup .....</b>	<b>64</b>
4-1. Transporter Viewer Setup.....	64
4-2. Remote Setup .....	68
4-3. Remote Upgrade .....	69
<b>5. Transporter Callback .....</b>	<b>70</b>
<b>Appendix A. Remote Access Using Internet Explorer .....</b>	<b>72</b>
<b>Appendix B. Setting DDNS Using Router .....</b>	<b>73</b>
1. Domain Name Creation .....	73
2. Router Configuration.....	76
3. DVR Configuration .....	77
<b>COMPLIANCE NOTICE OF FCC: .....</b>	<b>78</b>
<b>WEEE (Waste Electrical &amp; Electronic Equipment).....</b>	<b>78</b>
<b>ROHS Compliance.....</b>	<b>78</b>

---

# Chapter 1. Introduction

## 1. The System

The Transporter provides the cutting edge of mobile recording solutions for any type of transportation security application. This mobile DVR was built upon industrial specification that offers the most reliable mobile solutions. Its industrial specification allows it to withstand any harsh conditions of shock, vibration, and temperature. Explore our new Transporter and be protected by the most reliable in-vehicle device.

## 2. General Features

- Advanced H.264 Linux Embedded DVR
- Live View, Remote Playback, File Backup, E-mail Notification
- 30fps @ D1, 120fps @ CIF
- 4 Channel Video / 4 Channel Audio Recording
- G-Sensor Technology
- GPS Driven by Google Map
- Wireless Communication Access Any Transporter Via External Wireless Bridge or Wireless Mobile Router
- Central Management Software up to 64 Channels
- Support Blackberry, iPhone, and 3G Phone
- 3 Year Limited Warranty



# Transporter

### 3. Specification

Model		Transporter
Video	In	4 Channel
	Out	1 CVBS
Audio	In	4 Mic-In
	Out	1 Line-Out
Device	Sensor In	2 TTL
	Alarm Out	2 Relay
	I/O Interface	RS232, RS485, USB2.0 x 1, USB1.1 x 1 for Mouse
Display	Speed	Real Time
	Resolution	720 x 480 (NTSC), 720 x 576 (PAL)
	Split Screen	1, 4, PIP, Digital Zoom
Recording	Compression	H.264 Codec
	Speed / Resolution	120fps@CIF (NTSC) 100fps@CIF (PAL) 60fps@Half D1 (NTSC) 50fps@Half D1 (PAL) 30fps@D1 (NTSC) 25fps@D1 (PAL)
	Picture Quality	Very High, High, Standard, Low
	Mode	Time-Lapse, Event, Time & Event
Playback	Display	1, 4, Digital Zoom
	Search Mode	Calendar Search, Event Search, Text-In Search, Go to Time
	Playback Mode	Multi-Channel Normal & Reverse Play, RW & FF (x2, x4, x8, x16, x32), Frame to Frame, Pause
	Map	Associated Google Map
Network	Interface	Ethernet (10/100 Base)
	Protocol	TCP/IP, HTTP, DHCP, ADSL (PPPoE)
	Application	Live, Playback, Setup, Notification (Callback, E-Mail)
	Web Browser	Internet Explorer 7 or Higher
Storage	Removable Rack (2.5" SATA HDD, SSD, & SD Card)	
Backup	External HDD, USB Memory	
Control	USB Mouse, IR Remote Controller, Joystick Controller	
OSD	Graphic User Interface (Multilingual)	
Approval	FCC, CE, KCC	
RoHS	RoHS Compliance	
Power Consumption	DC12V~36V, Max 64W	
Operating Temperature	-20°C ~ 50°C / -4°F~122°F (Built-In Heating System)	
Operating Humidity	0%~80% / Non-Condensing	
Dimension	225.5(W) x 59(H) x 245.2(D) mm 8.87(W) x 2.32(H) x 9.65(D) inch	
Weight	1.63 kg / 3.6 lbs (with 250G HDD)	









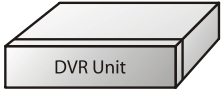

---

# Chapter 2. System Installation

## 1. Package Contents

The following components are included in the product:

DVR Unit	
Harness & Terminal Block	
Monitor Cable	
Power Cable	
Remote Controller	
CD (User Manual & Network S/W)	
Quick Guide	
Bracket Screws & Keys	
GPS Antenna	

---

## 2. Installation

### 2-1. Bracket Disassembly

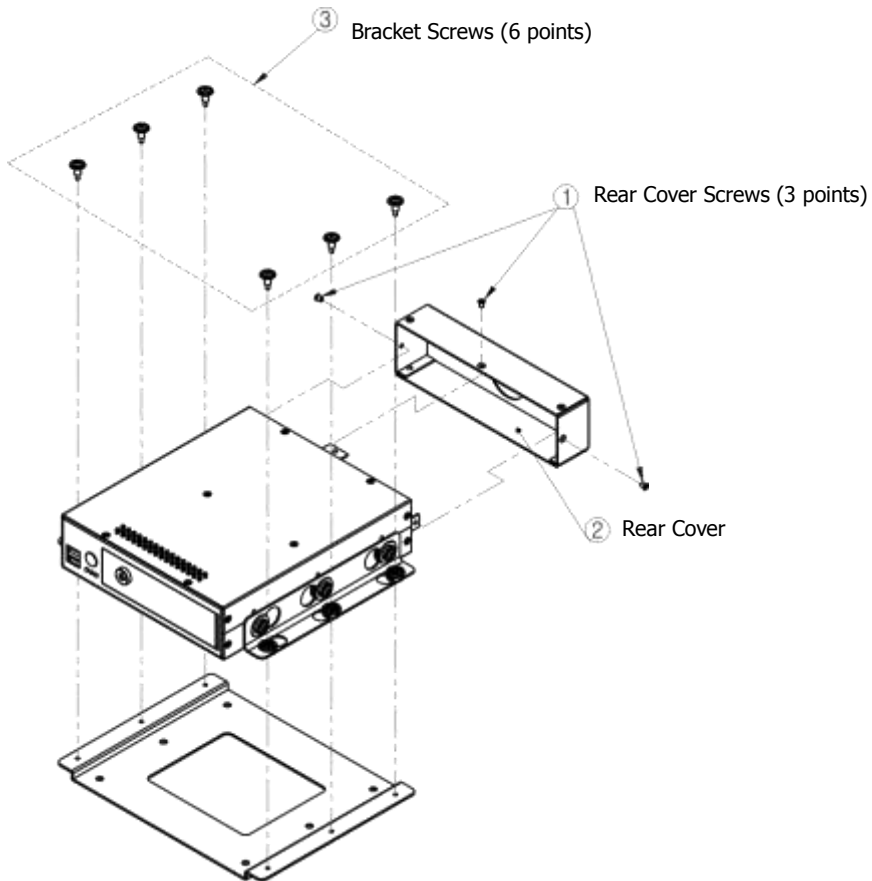

Take the unit out of the box and disassemble the brackets as follow:

- Unscrew Rear Cover Screws to remove Rear Cover.
- Unscrew Bracket Screws to remove Installation (bottom) Bracket.
- The installation bracket has the following size, and it must be bolted down on the bottom or top surface strongly using the 6 Bracket Screws.

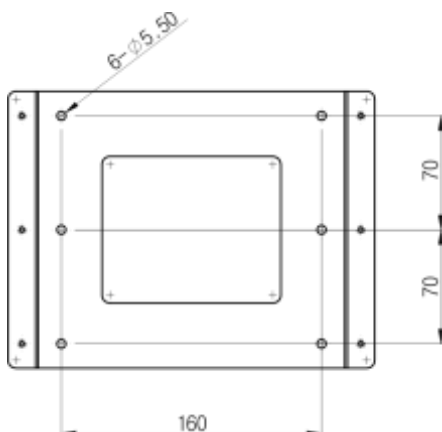

---

## 2-2. Unit Installation

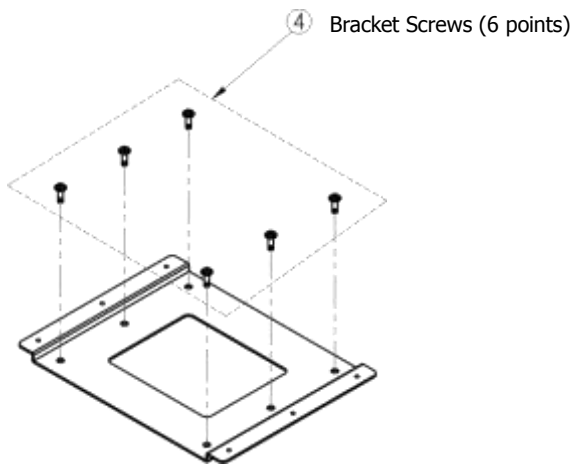

Bolt down Installation Bracket on the bottom or top surface, using the six Bracket Screws.



- To install the unit on the bottom, just use the bracket screws to bolt down the unit with the installation bracket.
- To install the unit on the top, turn the installation bracket upside down and bolt the unit with the installation bracket.

**Note:** Please do not install DVR as shown below. Inappropriate installation of DVR will affect HDD's stability or operation.

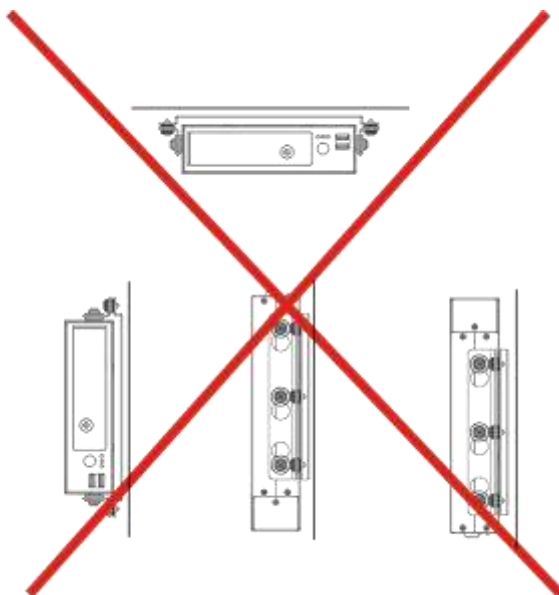

## 2-3. Connection Devices

The front and rear panel of the Transporter comprise of the following:

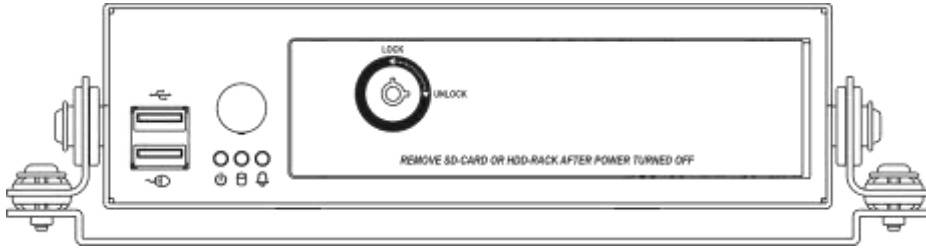

- **Front USB:** Two USB ports are provided to connect external devices like HDD, USB Flash Drive for Backup and System Upgrade, or USB Mouse on the front panel. A USB Mouse can be connected only to the bottom USB port on the front panel. The specific USB port is only for the mouse.

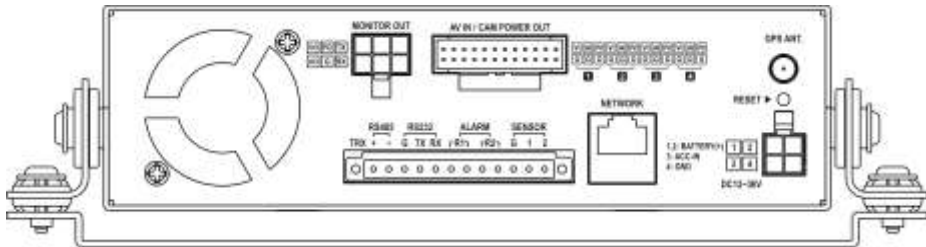

**Note:** Before connection the cables/connectors, make sure they are all through the Rear Cover Hole. Lock the Rear Cover for easy arrangement.

### Video/Audio Input, Camera Power Output

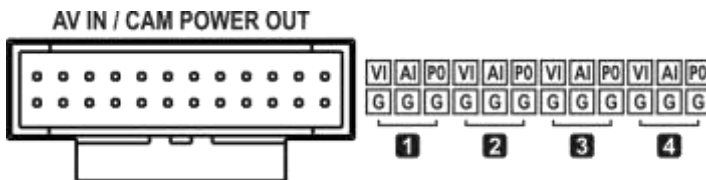

The unit has four groups of Video Input(VI), Audio Input(AI), and Camera Power Output(PO) as shown above. Use the 24 Pin Connector included in the box to connect cameras.

---

## Monitor Output

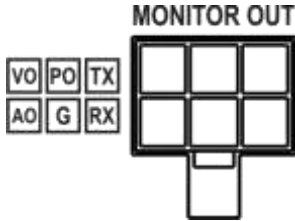

The connector for CVBS (NTSC or PAL) monitor. VO refers to Video Out, and AO refers to Audio Out. The Monitor power (12V) needs to be connected to PO. G (Ground) Pin is general for all outputs. 12V Monitor power is only supportable for a maximum 7" LCD monitor (TX/RX is not in any usage on this unit).

**Notice:** The total 12V/1.6A supports 4 cameras and 1 monitor.

## Power In

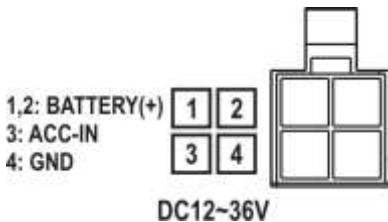

The DVR will operate on both 12V and 24V systems. Pins 1 and 2 should be connected directly to the positive (+) battery. Pin 3 should be connected to the positive (+) power bus bar that is turned on when the ignition switch is in the Accessory position. Pin 4 should be connected directly to ground.

## I/O Terminal Block

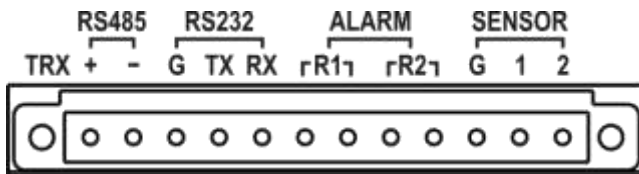

- **RS232C:** An RS232C Connector is provided to connect external devices such as ATM or POS machine for Text-In function.
- **RS485:** The RS485 Connector can be used to connect PTZ cameras. Transporter can also be controlled remotely by a control keyboard.
- **Alarm:** Alarm output connectors are provided to connect external alarms, such as sirens or lights. Two alarm output connectors have internal relays.
- **Sensor:** Two sensor input connectors are provided to connect external devices. You can use sensors to signal the DVR with event.

---

## Network Port

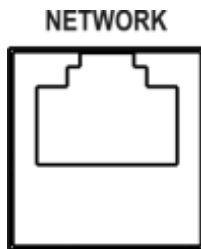

Connect a Cat5 Cable with an RJ45 Connector to the DVR for remote monitoring, remote playback, and remote setup. See **Chapter 3-2. DVR Configuration** for configuring the Network connections.

3G (GPRS) Router can be used for the wireless network connection. Connect 3G (GPRS) Router on the network port. For a detail usage of 3G (GPRS) Router, please contact your service provider of 3G networks or your 3G (GPRS) Router Manual.

ETC

GPS ANT.



RESET ► ○

- **GPS Antenna:** The unit has built in GPS. SMA type GPS antenna needs to be set up separately for the proper reception of GPS data.
- **Reset:** The DVR has a Reset switch that will only be used to return all the settings to the original factory settings. To reset the unit, turn the DVR off first. Turn it on again while poking the straightened paperclip in the reset hole. Hold the switch until the DVR is initializing.

---

### 3. Cautions

- Avoid installing the product near direct sun rays or near a heat generator. The excessive heat may cause fire.
- Do not place a vase, flowerpot, cup, cosmetics, drug, or any product that may contain water. It may cause fire or electric shock, and it may injure people by falling.
- Do not insert or drop any metal object (coin, hair pin, etc) or flammable object (match, paper, etc) into the air hole. It may cause fire or electric shock.
- Do not place any heavy object on your product. It may injure people or get destroyed when knocked down.
- Put power plug in a place where it will not be moved. If not, it can cause fire.
- Unplug power plug and antenna, when there are thunders and lightening. If not, it may cause fire.
- To clean the product, wipe surface with dry towel. Using chemical agent or cleaner may change the color and unpeel paint.
- Do not plug several plugs at same time. It may cause electric shock.
- If there is smoke or a strange smell, stop the operation. In this case, turn the power off and unplug it, and then contact our service center. Continuous use of the product may lead to fire or electric shock.
- Do not unplug by pulling the cord. If cord is damaged, it may cause fire or electric shock.
- Do not plug or unplug with wet hands. It may cause electric shock.
- Keep the power cord untwisted. It may cause fire or electric shock.
- Use proper adapter. Using too much electric power may cause fire or electric shock.
- Do not install it where it is exposed to rain, wind and water drops. It may cause fire, electric shock, and/or transformation.
- Keep away from fire.
- Do not disassemble or remodel on your own. It may cause malfunction or electric shock.
- Do not put next to flammable materials, like flammable spray. It may cause fire.
- Do not install it in a place with too much dirt. It may cause fire.
- Do not install it on unstable places like a shaking table, an inclined plane, or a shaking place. It may injure users by falling down.
- Do not place a heavy object on the power cord or avoid it from being pressed by the device. It may cause fire or electric shock.
- In case of using extension cord, do not use several devices at same time. It may cause fire with abnormal heating of the extension.
- When there is dirt on the power plug pin or power outlet, clean it nicely. It may cause fire.
- Do not damage on power cord by plugging, bending, twisting, pulling, or placing it between other objects or heat. If power outlet insertion part is not tight, do not use it. It may cause fire or electric shock.
- Do not drop or shock the product. It may injure people or cause malfunction.
- Do not touch power adaptor or signal controller. It may cause electric shock.
- Do not place an object too close to the cooling fan. It may cause fire.
- Exchanging batteries with an improper type can cause an explosion.
- For used batteries, throw away separately from other garbage.
- When you take out batteries, keep them away from children. Avoid children from consuming the battery by mistake. If a child accidentally eats a battery, contact a doctor right away.

# Chapter 3. Using DVR

## 1. Basic Operation

### 1-1. Front Panel & IR Remote Controller

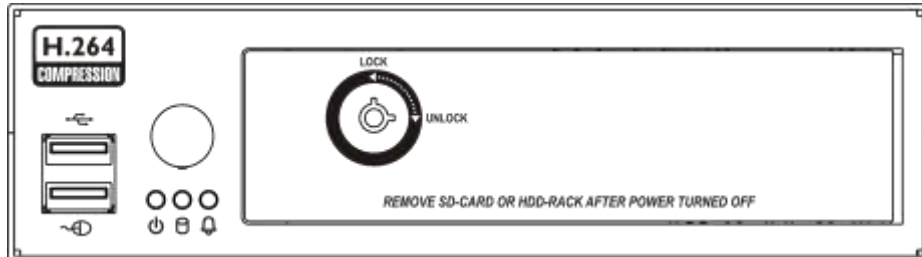

Front Panel	Description
USB Port	Two USB ports are located on the front panel. As directed in the picture, a USB mouse can be connected to the USB port dedicated only for the mouse.
Status LED	<p>  Power              HDD              Alarm         </p> <p>  &gt;  &gt;  : Indicates Normal system booting         </p> <p>  Blink: Indicates Front Cover is not closed properly         </p> <p>  On/  Blink: Indicates the heater is on due to low temperature and needs to wait until it reaches operating temperature level.         </p>
Lock Key	Use the key included in the box to open the door and install or uninstall the HDD rack. To remove the HDD rack while the system is running, open the door and wait for about 10 seconds until the Power LED starts flickering for the safe removal of HDD rack.

Remote Control Button	Description
Camera Buttons (1~0)	Pressing camera buttons and Enter button will cause the selected camera to display full screen. Buttons are used to enter passwords.
MENU / EXIT Button	Enter the Setup Menu. User will need to enter the authorized password to assess Setup. In Playback mode, MENU button displays the Playback Menu.
DISPLAY Button	Change the screen display mode in the current screen or playback screen.
SEQUENCE Button	Display live channels sequentially.



Up, Down, Left, Right Arrow, ENTER Buttons	Change settings for the product in MENU mode or in PTZ control mode.
BACKUP Button	Copy recorded data to an external storage device.
PLAYBACK Button	Change to playback mode from live mode.
PAUSE Button	Under playback mode, the button can be used to pause the playback screen. Display menu to save PTZ preset under PTZ mode.
▶ PLAY Button	Play the video forward. Press the button repeatedly to increase play speed up to max 32 times (1, 2, 4, 8, 16, 32 times) faster. Use this button to move right when setting the menu. Focus on far distance under PTZ mode.
◀ R.PLAY Button	Play the video backward. Press the button repeatedly to increase play speed up to max 32 times (1, 2, 4, 8, 16, 32 times) faster. Use this button to move right when setting the menu. Zoom Out under PTZ mode.
▶▶ STEP FORWARD Button	Move forward by one frame under Pause. Use this button to move up when setting the menu. Zoom Out under PTZ mode.
◀◀ STEP BACKWARD Button	Move backward by one frame under Pause. Use this button to move down when setting the menu. Zoom In under PTZ mode.
PTZ Button	Change to PTZ control mode from live mode.
ZOOM Button	Magnify the current image on the screen.
PIP Button	Change to PIP screen mode from live screen.
AUDIO Button	Select a camera for live & playback audio output.
OSD Button	Turn On/Off the OSD Display.
LOG Button	Check the system log information.
ID Button	Select the DVR system ID. (Remote controller Only)
E.REC Button	Pressing the E.REC button starts Emergency Recording Mode of all camera channels and displays "!" on the screen. Pressing the button again will stop E.REC Mode.

## 1-2. Turning on the System

If it is installed properly, the unit will start and run automatically when the ignition is turned on. It will take about 20-30 seconds for the boot up and start recording based on the pre-setup options. If the temperature is below -0°C (32°F), the unit will start recording after HDD is heated by our built-in heating sensor.

If SD card is installed with HDD, it will start recording on SD Card while HDD is being heated. Once HDD is ready to record the data, it will stop the recording on SD and automatically start recording data on HDD.

The unit will stop recording automatically once the ignition is turned off. The unit only runs while the ignition is on.

**Note:** The HDD Rack can be removed and played on PC. However, it is recommended to remove the HDD Rack once the unit is turned off safely. To remove the HDD rack while the system is running, open the door and wait for about 10 seconds until the Power LED starts flickering for the safe removal of HDD rack.

**Note:** When installing the HDD for the first time, the HDD should be formatted first.  
"MENU > RECORD > Storage > HDD Format"













## 1-3. Menu Bar

The menu bar will appear on the bottom of the screen as shown below.



	Pressing the Menu will bring up the main menu list.
	Shows the percentage of HDD being used.
	Turns on when the HDD is set to be overwritten.
	Receiving GPS data
	Turns on when the system is connected to the network.
	Turns on when the Alarm is being activated.
	G-Sensor is detected.
	E.REC (Emergency Recording) Mode
	Displays date & time.
	IR Remote Controller

## 1-4. Display Icons

	No Recording
	Recording (Red)
	E.REC (Emergency Recording)
	Event Recording (Red)
	Pre-Event Recording (Blue)
	Motion Detection
	Sensor Detection
	Text-In
	PTZ Camera
	Instant Backup
	Clip Maker (Blue)
	Backup (Red)
	Video Loss

## 1-5. User or Admin Login

Login

ID : Administrator ▾

Password :

0123456789

Press MENU to enter main menu screen. Login screen appears for you to enter ID (Administrator or User) and Password. Password can consist of up to 8 numbers by the combination of numbers from 0 to 9.

The factory default password is 'none' so press  to login to the system for the first time. Password can be set under password setup option (*MENU > SYSTEM > User*).

The system will automatically logout, if it is not in-use for a certain period of time. This "Auto Logout Time" can be set under password set up option (*MENU > SYSTEM > User*).

## 1-6. The Main Menu

The Main Menu of DVR consists of SYSTEM, DEVICE, DISPLAY, RECORD, NETWORK, and EVENT. Each menu consists of various sub-menus that allow detail set up of the system. Use Mouse, Remote Controller, or Front Buttons for access to each menu.

**Note:** To prevent any unauthorized changes of system settings or operations, please make sure the system logout is done when the system setting or operation is completed.

MAIN MENU	SYSTEM	Information
		Date & Time
		User
		Quick Setup
		System Log
	DEVICE	Camera
		Audio
		Alarm
		Keyboard
		RS232 & RS485
	DISPLAY	Display
		Monitoring
	RECORD	Storage
		Record
		Record Tools
	NETWORK	Address
		DDNS
		Notification
		Transmission
	EVENT	Sensor
		Motion
		Video Loss
		Text-In
		System
		G-Sensor
	LOGOUT	
SHUTDOWN		

## 1-7. Contextual Menu

Camera	>	
Layout	>	2 x 2
OSD	>	3 x 3
Freeze		1 + 12
Sequence		✓ 4 x 4
Zoom		Next Page
PIP		Previous Page
Spot		
Audio		
PTZ		
Backup		
Playback		
Emergency Record		
Log		
Eject		
Setup Menu		

Additional Contextual Menu screen appears by clicking the right button on the Mouse. Layout option allows you to change the displayed camera(s) on the monitor. Select preferred camera display option on the monitor.

<b>Camera</b>	: Select camera number
<b>Layout</b>	: Select display mode (8/16 Channel DVR Only)
<b>OSD</b>	: Select OSD display option
<b>Freeze</b>	: Pause current image display
<b>Sequence</b>	: Begin sequence display
<b>Zoom</b>	: Zoom in image by x2
<b>PIP</b>	: Select PIP mode and camera
<b>Audio</b>	: Select audio outs
<b>PTZ</b>	: Select PTZ options
<b>Backup</b>	: Select backup options
<b>Playback</b>	: Playback recorded data
<b>Emergency Record</b>	: Start Emergency Recording
<b>Log</b>	: Select system/event log
<b>Setup Menu</b>	: Enter main setup menu

For more information on Contextual Menu, please refer to 2. DVR Configuration.

## 2. DVR Configuration

### 2-1. SYSTEM

Under SYSTEM menu, system configuration options for general Information, Date & Time, User, Quick Setup, and System Log can be selected.

#### 2-1-1.MENU>SYSTEM>Information

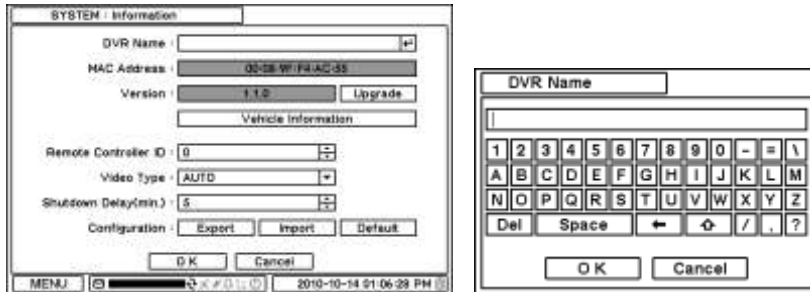

In the Information screen, DVR Name, System Version Upgrade, Mac Address, and Configuration options can be selected. Highlight and press DVR Name  to enter or change DVR name. Name the DVR by using the virtual keyboard.

To Upgrade the system, save the upgrade file to a USB Flash Memory and connect it to DVR. Once the Device is connected, press Upgrade button to execute system upgrade. Upgrade will take approximately 5 minutes. DVR will reboot automatically when the upgrade is completed.

**Note:** DO NOT remove USB Flash Memory or turn off the system during the upgrade. It may cause the system to malfunction.

#### Vehicle Information



Enter Company Name, Vehicle Maker, Vehicle Model, Registration Number, License, and Driver Name.

#### Remote Control ID

Enter Remote Control ID to control multiple DVRs individually. If Remote Control ID remains as 0, Remote ID does not have to be selected when using remote controller. It will work as general ID for any remote controls and a remote control will communicate with any DVRs with ID 0.

---

### **Video Type**

The system automatically detects camera signal type as NTSC/PAL, but the system also offers manual selection options for different signal types.

### **Shutdown Delay (in minutes)**

Set Shutdown Delay time after Ignition is off. The system power will stay on according to the Shutdown Delayed time set in the menu. The time can be set from 5 to 60 minutes.

### **Configuration**

System settings can be saved and loaded using Configuration option.

- **Export:** Save settings to USB Flash Memory
- **Import:** Load saved settings from USB Flash Memory
- **Default:** Load factory default settings

**Note:** Configuration Import does not affect or change system and network settings. Network settings will also not change when Default option is selected.

## 2-1-2. MENU > SYSTEM > Date & Time

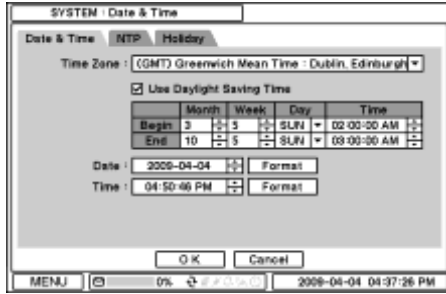

In the Date & Time window, Time Zone, Date, Time, NTP Server, Holiday options can be selected.

Highlight and press Time Zone  to select the correct Time Zone.

Select "Use Daylight Saving Time" if it is applicable. Enter start and end date/time for local "Daylight Saving Time".

Press  button to set up Date and Time. Press  button to select a date & time display format.

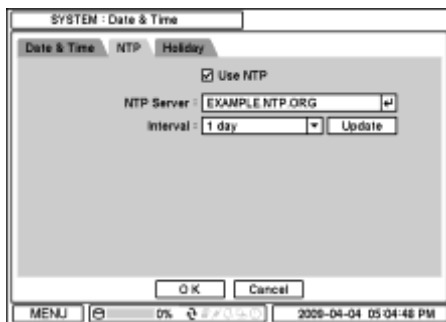

Select "Use NTP" for Time Servers to be synchronized with DVR. Highlight text and Press  to enter Time Server using the virtual keyboard. Press  to synchronize the DVR time with the registered time server.

**Note:** NTP is not essential for DVR operation. Any type of Standard Time Server can be used (i.e. time.windows.com). Time Synch might not be completed due to delays from the Time Synch server.

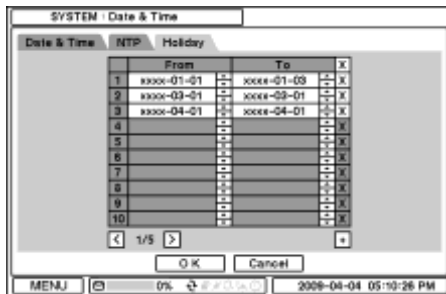

Press Holiday to set specific dates for Holiday setup. Set specific date by pressing  button. Change and delete dates using  and  buttons.

**Note:** Some Holidays fall on different days. Therefore, they have to be updated every year.

**Note:** When the DVR receives GPS after booting up, it updates the time and date automatically using GPS information.



### 2-1-3. MENU > SYSTEM > User



Press [User] tab to enter/add a new user.

- **Auto Login:** Allows user to login right after the system boots up automatically. If a system allows auto login without the authentication process, please make sure DVR has a limited access by non authorized personnel.
- **Auto Logout:** Turn  On or  Off Auto Logout option.
- Press  to add a new user. To remove an existing user, press  next to it.
- **User Name:** Enter a user name
- **Group:** Select a Group which the new user will belong to.
- **Password:** Set a new password or change a password.

**Note :** DO NOT have to enter Current password when setting password for the first time, for there is no default password for Administrator/User.



Set user registration and access rights for the system. Press [Group] tab to add a group. Press  to add a new group. Enter a group name and select access rights for the group. To remove an existing group, press  next to it.

## 2-1-4. MENU > SYSTEM > Quick Setup

Quick Setup - System

DVR Name:

Language: English

Administrator Password: Setup

Time Zone: (GMT) Greenwich Mean Time - Dublin

Date: 2009-10-28 Format

Time: 01:40:43 PM Format

>> Close

MENU 91% 2009-10-28 01:40:43 PM

Quick Setup - Network

Type: Static IP

IP Address: 192.168.1.127

Subnet Mask: 255.255.255.0

Gateway: 192.168.1.1

DNS Server: 8.8.8.8

ID:

Password:

<< >> Close

MENU 2010-10-25 03:54:20 PM

Quick Setup - Network Port

Network Port: 10101 (1500 - 32000)

Web Port: 80

RTSP Port: 554

iPhone Port: 10104 (1500 - 32000)

<< >> Close

MENU 2010-10-25 03:54:44 PM

Quick Setup - Record

Overwrite

Resolution: CIF

Quality: Standard

bps: 30

<< >> Close

MENU 2009-08-01 05:58:01 PM

Quick Setup - Storage

Capacity	Type	Usage	Status
149.99 GB	HDD	Record	Good

Format

<< >> Close

MENU 0% 2009-12-09 01:42:35 PM

[Quick Setup] Menu allows easy and basic setup for main menu settings.

## 2-1-5. MENU > SYSTEM > System Log

SYSTEM: System Log

Time	Contents
2009-09-01 05:30:54 PM	Login: Administrator
2009-09-01 05:30:51 PM	System startup
2009-09-01 05:28:48 PM	Login: Administrator
2009-09-01 05:28:44 PM	System startup
2009-09-01 05:25:09 PM	Login: Administrator
2009-09-01 05:25:00 PM	System startup
2009-09-01 05:23:58 PM	Login: Administrator
2009-09-01 05:23:53 PM	System startup
2009-09-01 05:13:22 PM	Login: Administrator
2009-09-01 05:13:18 PM	System startup
2009-09-01 03:17:15 PM	Shutdown

1/2 Export Reload

Close

MENU 91% 2009-09-01 06:18:20 PM

In the [System Log] window, user can search for a full list of system logs.

Press **Reload** button to refresh log list. Use **<** **>** buttons to search log list page by page.

Log list can be exported in txt format.

## 2-2. DEVICE

Under [Device] menu, Device configuration options for Camera, Audio, Alarm, Keyboard, RS232, and RS485 can be selected.

### 2-2-1. MENU > DEVICE > Camera



Set Camera display option. Camera display (video loss display) can be disabled by unchecking the box next to it. Press to change the Camera name.

Press button under Color to adjust video color. Click or drag a control box to adjust each color level.

### PTZ Control



Check the channel connected with PTZ camera. Selected PTZ from the menu appears by pressing right mouse button.

**Note:** PTZ can only be controlled in single screen mode.

Use icons on screen to control PTZ. If using a mouse, click arrows to move around PTZ and click icons for each functions of PTZ camera.

		Zoom Out
		Zoom In
		Focus on near distance
		Focus on far distance
		Save Presets
		Load Presets

## Covert Setting



Covert setting allows privacy on monitoring. If Covert is set, live image will not be displayed. Covert can be scheduled by day, time, and mode for each camera.

**Covert Low Mode:** No display of video image on screen, but OSD still remains on screen.

**Covert High Mode:** Neither video image nor OSD will be displayed on screen.

**Note:** Covert options will not affect recording data, as it only changes monitoring conditions.

### 2-2-2. MENU > DEVICE > Audio

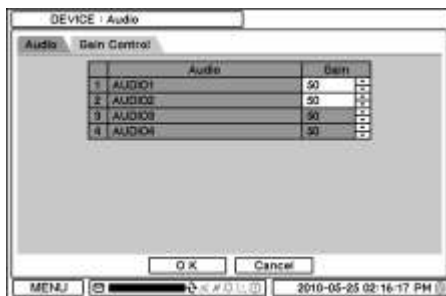

Select [Audio] tab for audio recording. [Gain Control] tab is available for Mic-In inputs (8/16 Channel DVR) only. Control Gain value using  $\uparrow/\downarrow$  button.

### 2-2-3. MENU > DEVICE > Alarm

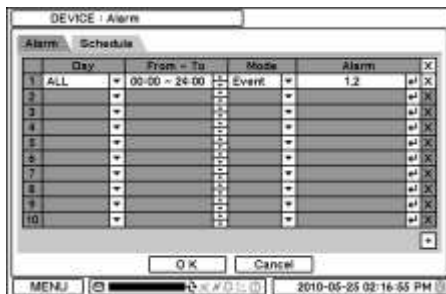

**Alarm Duration:** Set Alarm activation time from 5 seconds to 10 minutes.

Select [Schedule] tab to schedule Alarm operation. Alarm can be set by day, time, mode, and inputs (camera).



Press  $\left[ \text{Buzzer} \right]$  to select Alarms and set Buzzer with Alarm activation.

## 2-2-4. MENU > DEVICE > Keyboard

DEVICE : Keyboard

Keyboard Model : TB-CN9R1

DVR ID : 0

OK Cancel

MENU 0% 2008-04-04 07:58:36 PM

Press  to find and select keyboard from the list.

## 2-2-5. MENU > DEVICE > RS232 & RS485

DEVICE : RS232 & RS485

Port	Bps	Data Bit	Stop Bit	Parity	Usage
RS232	9600	8	1	None	Text-In
RS485	9600	8	1	None	PTZ

OK Cancel

MENU 0% 2008-04-04 08:00:44 PM

Press  to select a device for each port.

**RS232:** Supports Text-In (POS) device, PTZ, and Keyboard

**RS485:** Supports Text-In (POS) device, PTZ, and Keyboard.

**Note:** Text-In devices (i.e. Cash Register) needs to use ASCII code for Text-In information on DVR

## 2-3. DISPLAY

Under Display menu, Display configuration options for OSD and Monitor can be selected.

### 2-3-1. MENU > DISPLAY > Display



**Language:** Select system language. Press  to find available language options.

**Hide Status Bar:** Select  /  and Time to hide Status Bar, when system is not in use.

**OSD margin:** Set OSD margin (position), using .



**Freeze:** Display an image in either Field or Frame format when it is in still (freeze) mode.

**Layout:** Allows user to change or reallocate video inputs' (cameras) displays.



PIP (Picture In Picture) Size and its Display Positions can be selected under [PIP] tab. Please select desired size and positions of PIP display.

### 2-3-2. MENU > DISPLAY > Monitoring



**Event Pop-up:** Pops up the camera image in full-screen when pre-set event occurs.

**Sequence Interval:** Set time interval between cameras under sequence mode.

## 2-4. RECORD

Under Record menu, Record configuration options for Storage, Record, and Record Tools can be selected.

### 2-4-1. MENU > RECORD > Storage

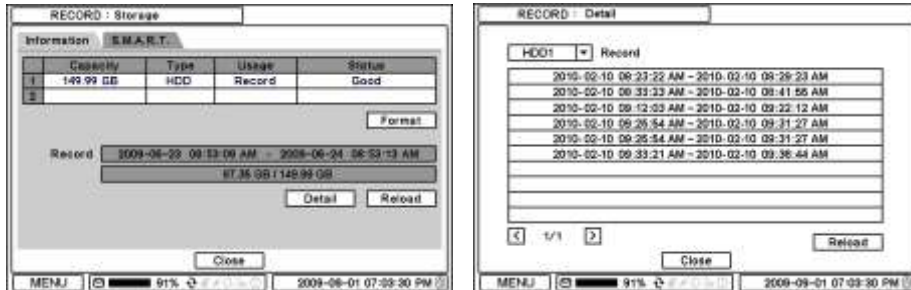

The storage displays the installed/connected storage status such as Capacity, Type, Usage, and Status.

**Format:** Press Format to format selected HDD.

**Record:** Displays the recording period and data stored on HDD.

**Detail:** Displays the detail information of data stored on HDD.

**Note:** If it is installed properly, the unit will start and record automatically when the ignition is turned on. It will take about 20-30 seconds for the boot up and start recording based on the pre-setup options.

If the temperature is below -0°C (32°F), the unit will start recording after HDD is heated by our built-in heating sensor. If SD card is installed with HDD, it will record on SD Card while HDD is being heated. Once HDD is ready to record the data, it will stop the recording on SD and automatically start recording data on HDD.

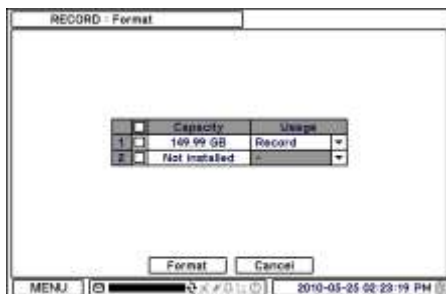

**Note:** Any changes or errors in installation of HDDs will stop mirroring and turn the system into record only mode. Mirroring allows data to record on two HDDs simultaneously. This will prevent unexpected loss of recording data due to HDD or system failure.

### 2-4-2. MENU > RECORD > Record

In Record, general recording options can be selected including overwrite, resolution, speed, recording quality and etc.

- **Overwrite:** Check Overwrite to overwrite recorded HDD data when it is full.
- **Audio Record:** Check Audio Record to record audio with video image.
- **Resolution:** Select recording resolution.
- **Auto Deletion (in days):** Turn on Auto Deletion to delete any data older than the defined days automatically.
- **Time Record:** Set ips/quality for continuous recording.
- **Event Record:** Set ips/quality for event recording.
- **Emergency Record:** Set ips/quality for emergency recording mode.



In Event, pre and post recording options for Event can be set.

**Pre-Event Duration:** Video Images occurred right before an Event can be recorded by setting Pre-Event under Event Mode. Duration of Pre-Event recording can be set up to 30 seconds.

**Emergency Record Duration:** Time duration can be set for Emergency Recording from 5 seconds to 30 minutes, or it can be set as continuously by selecting No Limit option.

**Event REC Duration:** Set recording duration for events up to 30 minutes.



In Schedule, fully detailed and specified recording schedules can be set by day, time, modes, cameras, and recording options.

Press **[+]** to add a new schedule. To remove an existing schedule, press **[X]**. Press **[Setting]** to set recording options.

**Use Default Setting:** Check "Use Default Setting" to follow main recording setting under Record menu.



### 2-4-3. MENU > RECORD > Record Tool



In Record Tools, estimated HDD usage and recording period can be calculated. Press Calculate once resolutions, ips, number of cameras, and quality are set. The recording period is calculated based on the size of the installed HDD.

The GB size shows the HDD size required for a day's worth of recording. Day and Hours show the period of time that can be recorded based on the installed HDD size.

**Note:** The calculation results show approximate data only. Same frame rate and video quality does not guarantee same storage size and recording duration. This is due to the variety of conditions on images such as more/less colors or more/less movements. This situational variance will affect the file sizes more at lower frame rate settings.

**Note:** Changes ips manually. Ips is not changed, according to the change in resolution. Approximate size for each resolution – CIF 360x240, HALF D1 720x240, D1 720x480.



In Recording Status, current recording options and statuses are displayed.

## 2-5. NETWORK

Under Network menu, Network configuration options for Network Address, DDNS, Remote Notification, and Transmission can be setup.

**Note:** 3G or higher mobile broadband is required.

### 2-5-1. MENU > NETWORK > Address

	Live	Playback	Setup
Port	10101	10102	10103
	Web	RTSP	iPhone
Port	80	554	10104

In Address, Information such as Type, IP address, Subnet Mask, Gateway Port, and DNS can be set for network connections.

- **Type:** Select the type of network configuration from: Static IP, DHCP, and ADSL (with PPPoE).
- **IP Address:** Enter IP address using button.
- **Subnet Mask:** Enter Subnet Mask using button.
- **Gateway:** Enter Gateway using button.
- **DNS:** Set up the IP address of the DNS server. If you setup the DNS Server, the domain name of the DVRNS server, instead of the IP address, can be used during the DVRNS Server setup.

In Port, select appropriate Port Number for external access to the system. The Port List shows necessary ports to be opened for each operation.

- **Network Port:** Set port for DVR Remote Client.
- **Web Port:** Set port for Web Remote Client.
- **RTSP Port:** Set port for Android based devices.
- **iPhone Port:** Set port for iPhone.

**Note:** ID and Password are required in ADSL (with PPPoE) type.

**Note:** Default TCP port is 10101, but it can be set from 1500 to 32000 if it is necessary.

### 2-5-2. MENU > NETWORK > DDNS

In the DDNS, network options for DDNS can be selected.

**DDNS:** Dynamic Domain Name Server allows dynamic network connections.

**Note:** "dvr-ddns.com" and "www.dyndns.org" offer free registrations for DDNS service. Please refer to the appendix for DDNS setup page.

**Host Name:** Name the DVR or site, by pressing and typing with the virtual keyboard.

**ID/Password:** ID and Password are required for Authentication.

**Note:** Use ID/Password registered in DDNS.

### 2-5-3. MENU > NETWORK > Notification

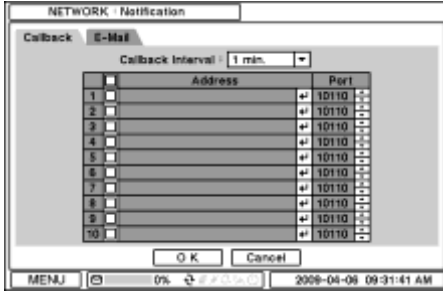

In Callback, setup IP addresses of client sites, so Events detected in local system can be notified to multi-remote client sites simultaneously. Enter IP addresses of client sites to receive event notifications on remote sites. Press **[F4]** to popup the virtual keyboard.

**Callback Interval:** Select Callback Interval to set time interval between the consequential events being sent to remote site.

**Note:** Any events that occur between the preset interval time will not be sent to remote site. For example, if the interval is set as 30 seconds, only the events that occurred every 30 seconds since the first event will be sent to remote site.



Events can be notified to personal email addresses through text message.

**E-Mail Interval:** Select E-Mail Interval to set time interval between the consequential events being sent to remote site via email.

**Recipient:** Enter the email address of a recipient. Up to 5 recipients can be entered.



**Note:** Any events that occur between the preset interval time will not be sent to remote site. For example, if the interval is set as 30 seconds, only the events that occurred every 30 seconds since the first event will be sent to remote site.

**SMTP Server:** Enter SMTP server using the virtual keyboard. SMTP server information can be obtained from a system administrator.

**Sender:** Enter the address/name where the email is being sent from.

#### 2-5-4. MENU > NETWORK > Transmission

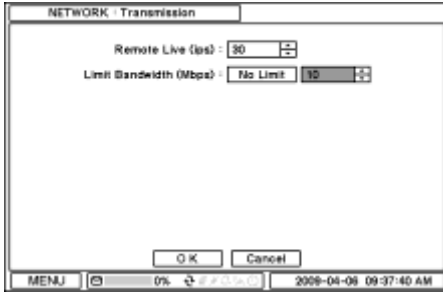

In Transmission, Network transmission can be controlled with ips and bandwidth.

**Note:** Maximum ips on Network Transmission is 60ips (NTSC) / 50ips (PAL)

## 2-6. EVENT

Under Event menu, events can be set in synchronization with Sensor, Motion, Video Loss, Text-In, System, G-Sensor

### 2-6-1. MENU > EVENT > Sensor



In Sensor, each sensor can be selected for activation, and the sensor type can also be selected. Select Sensor Type using  button.

- **NC**: Normally Closed
- **NO**: Normally Opened

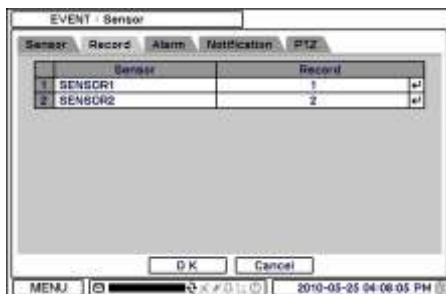

In Record, each sensor can be synchronized with single and multi cameras. Press  to synchronize the camera(s) with sensors.



In Alarm, each sensor can be synchronized with single and multi alarms. Press  to synchronize the alarms with sensors.

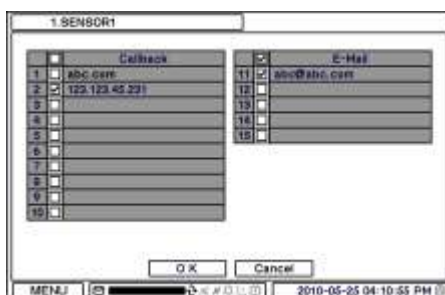

In Notification, each sensor can be synchronized with single and multi callback or emailing sites. Press  to enter the callback or email address to be synchronized with sensors.



PTZ can be synced with Event, using its preset function. If Event occurs, PTZ moves to the position where event and positions are preset. The above menu shows Sensor 1 set to sync to cameras 1,2. If you click PTZ section, PTZ preset (position) can be set for cameras in the event of Sensor activation.

PTZ event-related preset can be synced only with Sensor/Motion/Video Loss Events. If multi-events occur to a camera at same time, it takes events in order of *Sensor > Motion > Video Loss*.

## 2-6-2. MENU > EVENT > Motion



In Motion, system provides Motion Detection function. Set Motion Detection using Sensitivity, View, and Area options.

- **Sensitivity:** Select motion sensitivity from Very Low to Very High.
- **View:** Turn On or Off the appearance of motion zones on screen when motion is detected.
- **Area:** Define the area for motion detection.

Press Setup under Area to define motions detection areas. The blocks indicate the area that is defined for motion detection.

- **Select Block:** Use arrow keys to move around a box. Select individual blocks to set motion zones. Use number keys to select and unselect blocks. When using a mouse, use the left button.
- **Clear Block:** Unselect all blocks inside a box.
- **Select All:** Select blocks on entire screen.
- **Clear All:** Unselect blocks on entire screen.



In Record, each camera can be synchronized with single and multi-motion detections from other cameras. Press **[↔]** to select cameras to be synchronized with motions detections.



In Alarm, each camera with motion can be synchronized with single and multi alarms. Press **[↔]** to select alarms to be synchronized with cameras for motion events.



In Notification, each camera with motion can be synchronized with single and multi callback or emailing sites. Press **[↔]** to enter callback or email address to be synchronized with cameras for motion events.



PTZ can be synced with Motion event, using its preset function. If Motion is detected, PTZ moves to the position where event and positions are preset.

### 2-6-3. MENU > EVENT > Video Loss



In Video Loss, single or multi cameras can be synchronized for event recording when there is a video loss. Press **[←]** to select single or multi cameras to be synchronized with cameras for video loss.



In Alarm, each camera with video loss can be synchronized with single and multi alarms. Press **[←]** to select alarms to be synchronized with cameras for video loss.



In Notification, each camera with video loss can be synchronized with single and multi callback or emailing sites. Press **[←]** to enter callback or email address to be synchronized with cameras for video loss.



PTZ can be synchronized with Video Loss event, using its preset function. If Video Loss occurs, PTZ moves to the position where event and positions are preset.



## 2-6-4. MENU > EVENT > Text-In

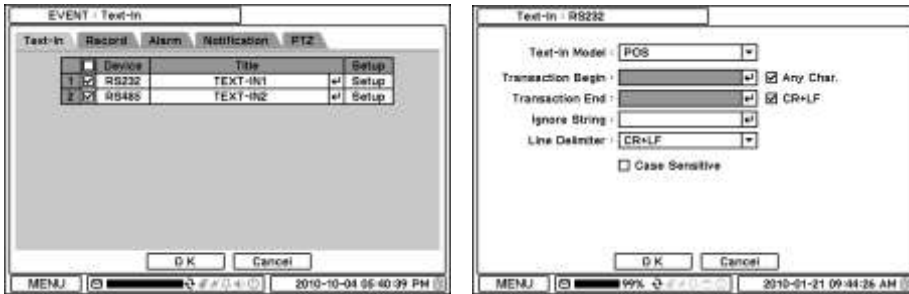

The system allows Text-In from POS/ATM machines.

**Note:** For use of POS/ATM, the system must support general ASCII code

- **Text-In Model:** Select Text-In model from the list.
- **Transaction Begin:** Enter a word that will be displayed before the Transaction begins.
- **Any Character:** Check "Any Character" to display a text with any character.
- **Transaction End:** Enter a word that will be displayed on the screen when the transaction ends. If you want additional lines to be displayed for Transaction End, select more line options.
- **Ignore String:** Enter a word to ignore strings.
- **Line Delimiter:** Enter a symbol or a word to distinguish the ending of lines.
- **Case Sensitive:** Select "Case Sensitive" option to distinguish a word with case sensitivity.

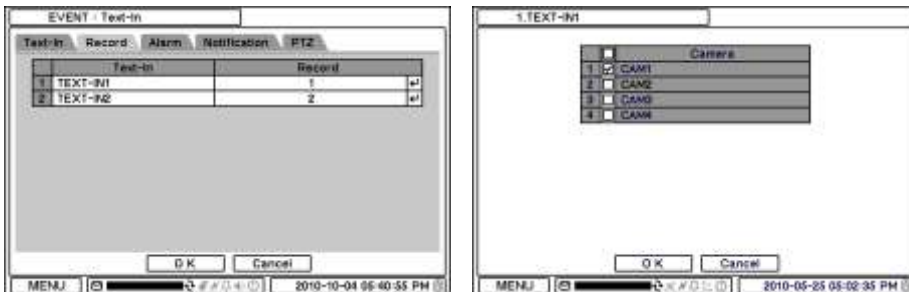

In Record, text event can be synchronized with single or multi camera record. Press to select camera(s) to be synchronized with text event. If RS232 and RS485 port are being used at the same time, they have to be used for different cameras. For example, if RS232 is set for cameras 1~12, RS485 should be set for cameras 13~16. They cannot share the same cameras.

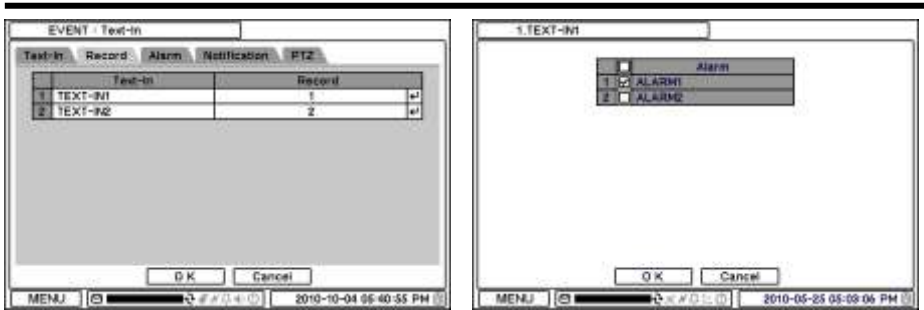

In Alarm, text event can be synchronized with single or multi alarms. Press  to select alarms to be synchronized with text event. If B is selected, system will buzz on alarm detections.

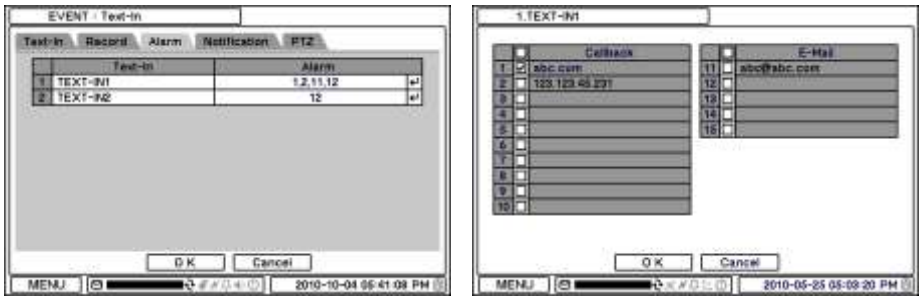

In Notification, text event can be synchronized with single and multi callback or emailing sites. Press  to enter callback or email address to be synchronized with text event.

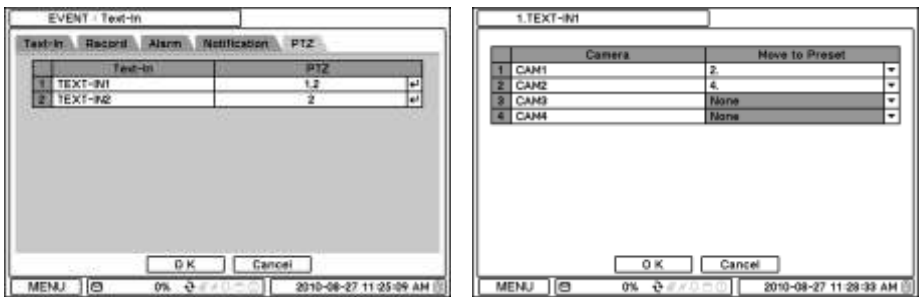

In Text-In, each text input can be synchronized with single and multi cameras. Press  to select cameras to be synchronized with text inputs.

## 2-6-5. MENU > EVENT > System



In System, S.M.A.R.T function monitors storage conditions such as Temperature, Conditions, and Recording.

S.M.A.R.T Threshold allows user to preset tolerable temperature levels of storage. If HDD temperature increases over preset temperature, it will notify a user in various ways according to following settings.

Record Threshold option can be set to notify a message for the indication of HDD storage usage level. Warning message can be notified in various ways as described below.

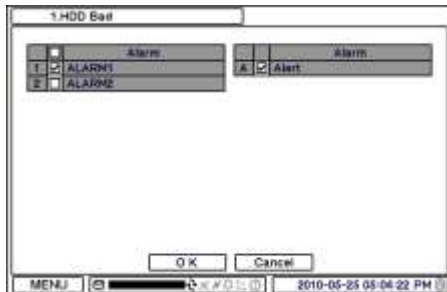

In Alarm, each system event can be synchronized with single and multi alarms. Press  to select alarms to be synchronized with each event. If Alert is selected, system will popup a warning message on screen.

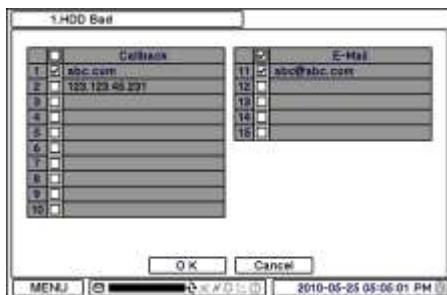

In Notification, each system events can be synchronized with single and multi callback or emailing sites. Press  to enter callback or email address to be synchronized with system events.

## 2-6-6. MENU > EVENT > G-Sensor

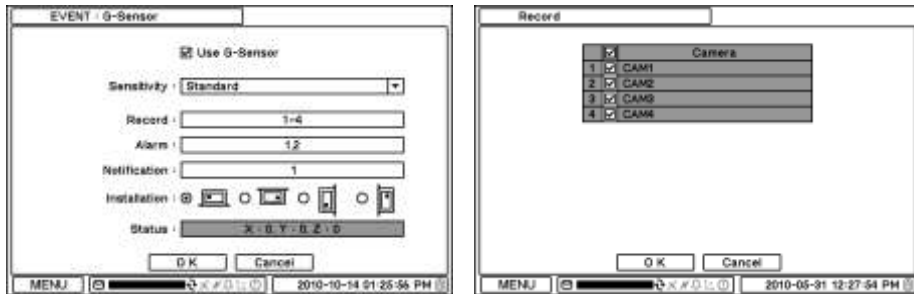

The built-in G-Sensor detects Quick Start, Quick Stop, and Traffic Accident. It associates Recording, Alarm, and Event Notification with detected information.

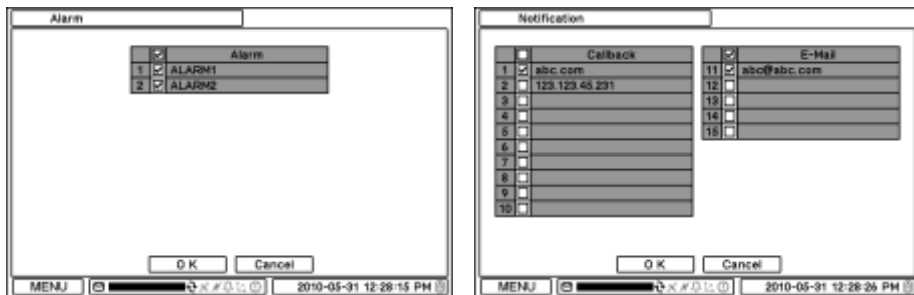

- **Use G-Sensor:** Enable or Disable the use of G-Sensor.
- **Sensitivity:** Setup the sensitivity of G-Sensor. There are five levels of Sensitivity.
- **Record:** Select the camera associated with G-Sensor that you will like to record.
- **Alarm:** Select the alarm associated with G-Sensor that you will output.
- **Notification:** Select the address associated with G-Sensor to where you will send notifications.
- **Installation:** DVR needs to be installed as shown on the first image. *Follow other reference images, only if SD or SSD is being installed.*

### 3. Playback

The system provides various playback functions to search recorded data. Click the right mouse button on Search mode and select the Storage Type. If backup data is selected, the data on external HDD can be searched.

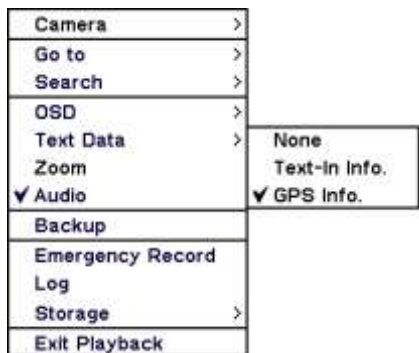



**Note:** To see the GPS information during playback, Contextual Menu -> Text Data -> Select GPS Info.

- Camera** : Select camera number
- Go to** : Search recorded data by date and time; move to the beginning or end of recorded data; or search data by 5/10/15/30/60 seconds before the current time of search
- Search** : Select Calendar Search, Event Search, and Text-In Search
- OSD** : Select OSD display option
- Text Data** : Select Text display option for Text-In and GPS Information
- Zoom** : Zoom in image by x2
- Audio** : Select Audio out
- Backup** : Select backup or Clip Copy option
- E. Record** : Start Emergency Recording
- Log** : Select System/Event log
- Storage** : Select playback storage option
- Exit Playback** : Exit Search Mode and return to Live Mode

### 3-1. Go to Time



Select Go to Time to search recorded data by time and date. Set time/date using  button. Go to Beginning and End options are selectable to search the very first and last data recorded. Once desired settings are completed, press  to begin playback.

- **Go to Beginning** : Move to the very first recorded data.
- **Go to End** : Move to the most recent recorded data.

### 3-2. Calendar Search

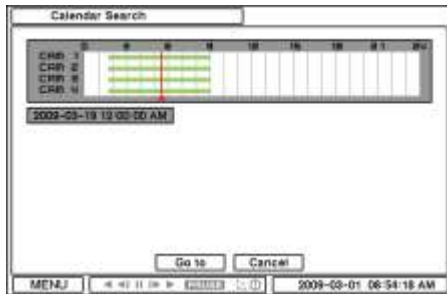

Calendar Search provides easy graphical search by displaying dates. Dates with recorded data will be highlighted. Once you select the date, it will display the recorded time table. The numbers on the top of the table shows the time frame in 24hours format, and the titles on the left indicate cameras numbers. The color bar shows the recorded data on the selected date. Move the indicator (line) to select a specific recorded time of the selected date. For a detail display of recorded data, please press  .

When the desired settings are completed, press  to begin playback.

### 3-3. Event Search

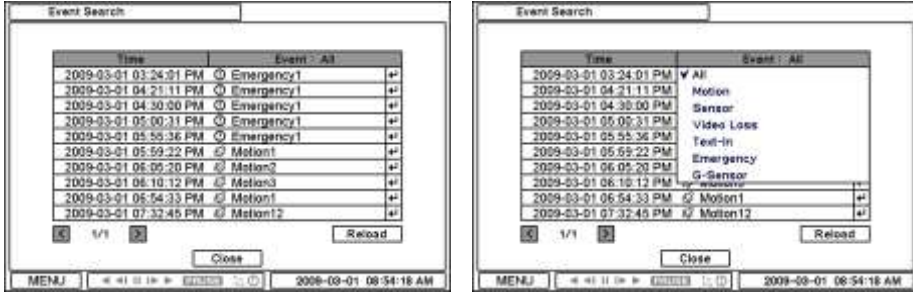

Event Search provides easy search by recorded event list. Select the date and type of event to find specific data. Press **Event : All** on the top of the list to display event search options.

- **All:** System displays every event
- **Motion:** System displays every event related to Motion
- **Sensor:** System displays every event related to Sensor
- **Video Loss:** System displays every event related to Video Loss
- **Text-In:** System displays every event related to Text-In
- **Emergency:** System displays every event related to Emergency Recording
- **G-Sensor:** System displays every event related to G-Sensor

Once the specific list of event is found, use the move up and down buttons to highlight the log and press it to playback the event data.

### 3-4. Text-In Search

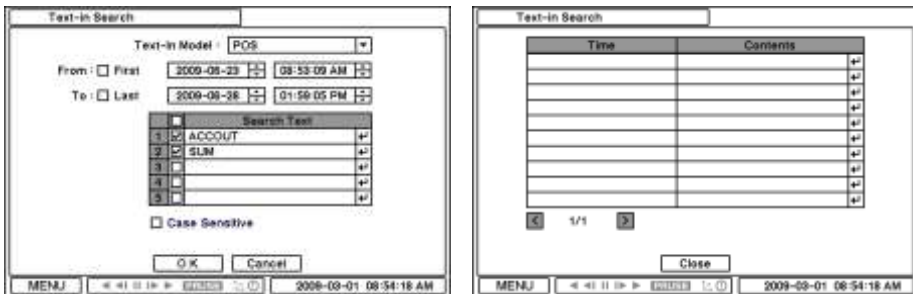

Text-In Search provides easy search by transactions.

- **Text In Model:** Select a model type for Text-In
- **From:** Set beginning time to start search or check "First" to search from the first data.
- **To:** Set end time to end search or check "Last" to search to the last data.
- **Search Text:** Enter any words to search for in the data.
- **Case Sensitive:** Select Case Sensitive option if you wish to distinguish a word with case sensitivity.

Once all the search information has been entered, press **OK** to start Text-In search.

---

### 3-5. Backup Data Playback



Backup files on backup media can be played on the DVR. Insert the media with backup files and select the file you wish to playback on the DVR.

### 3-6. Playback Control



- **R.Play:** Reverse Playback
- **Step Backward:** Go to the previous image
- **Pause:** Freeze or Stop current image
- **Step Forward:** Go to the next image
- **Play:** Play the data at normal speed

To control the backward and forward playback speed, press ◀ or ▶ repeatedly. Playback speed can increase up to 32 times.



## 4. Backup

Recorded data can be backed up on USB Flash memory. Select backup or Clip Copy option during Search or Live mode by selecting Backup.



### 4-1. Backup

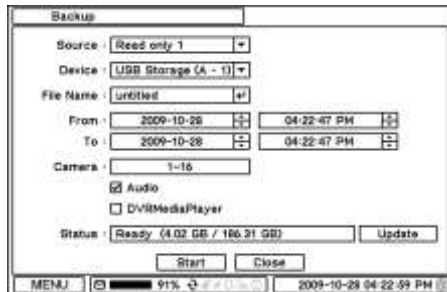

In BACKUP, the recorded data can be selected for backup to USB devices.

Press  for Device to select the type of USB Device connected to the system.

Select the time period to backup using  button.

Select Camera number or All to backup all the data recorded during the selected period. To backup recorded Audio with video data together check the box next to "Audio".

Status shows the capacity of the device being prepared for backup. It will show the backup progress during backup.



DVRMediaPlayer (.exe) format allows multi camera backup, and the saved files do not require any specific codec for playback on your PC. To open and play a file saved in DVRMediaPlayer (.exe) format, double click the file, and the video will automatically be played on Internet Explorer window. This function is supported only on Internet Explorer 7.0 or above.

**Note:** The backup process could be slowed down, if the system is being monitored/searched remotely on a client program.

**Note:** DO NOT remove the backup media while the data backup is being processed. It may cause critical damage to either the media or the system, if the backup media is removed during the backup process.

---

## 4-2. Instant Backup

Press **Backup** button to start Instant Backup during the playback. Instant Backup window will appear.

Select Device, File Name, and Audio; then, press **Start** to continue the playback and backup. The Backup Icon will appear on the screen during Instant Playback. Press **Backup** button one more time to stop and complete Instant Backup.

**Note:** DO NOT remove the backup media while the data backup is being processed. It may cause critical damage to either the media or the system, if the backup media is removed during the backup process

**Note:** Playback speed will be slower than usual, when instant backup is processing.

## 4-3. Clip Maker



Clip Maker allows you to create single channel backup files which can be played on your PC. Select Clip Maker option on the popup menu during the live or pause mode on the playback.

Select the backup option for Clip Maker. Press **Start** button to create Clip Maker. Use Quick Time player to play the file created using Clip Maker.

**Note:** The Clip Maker file can not be played on other programs, such as Window Media Player.

# Chapter 4. Transporter Viewer

## 1. Using Transporter Viewer

### 1-1. Starting the Software

Double click on "Transporter Viewer" icon on the PC to run the software.  
Main screen of the remote software appears as shown below.

**Note:** The minimum resolution is 1024 x 620, and the recommendable resolution is 1280 x 1024 or higher.

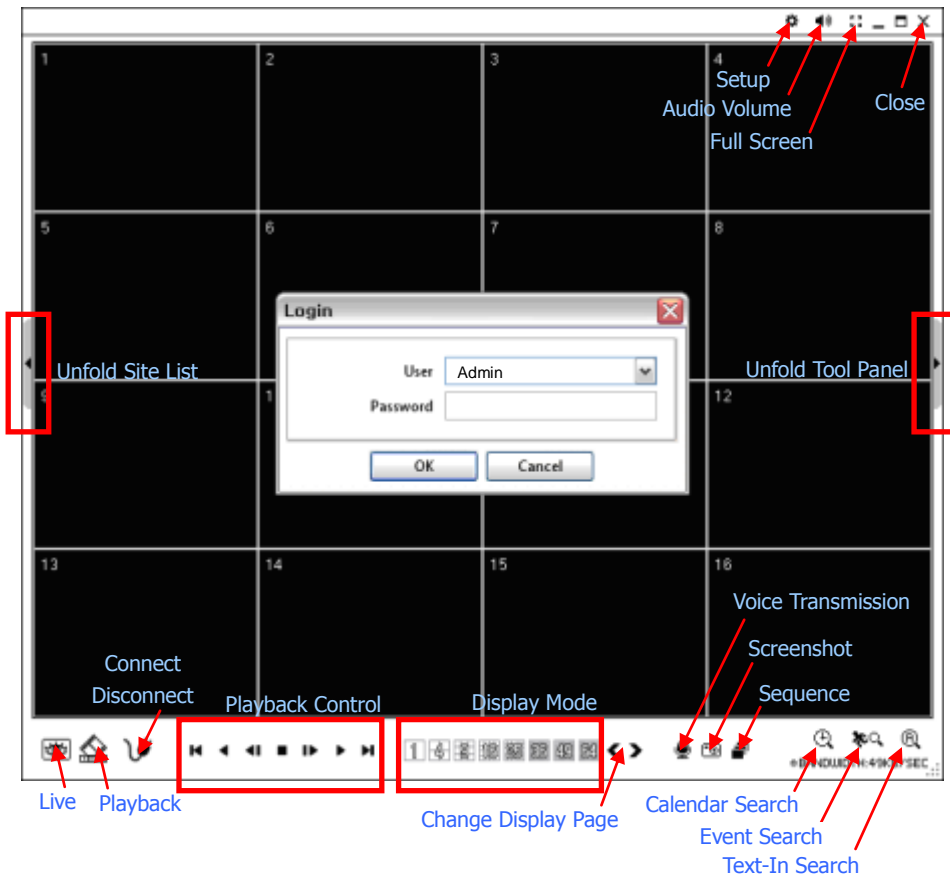

The Log In window will appear when Transporter Viewer starts. Select user. Each user will have a different authority level over the system control, depending on the pre setup. Enter **OK** once the user level is selected as the default password is 'none'.

- **Live:** Enter live mode.
- **Playback:** Enter playback mode.
- **Connect / Disconnect:** Connect a site as live or playback mode.
- **Playback Control:** Use buttons to control playback images. (Stop, Move by Image, Play, Rewind/Forward, and Move to First/End)
- **Display Mode:** Select display modes. (1, 4, 9, 16, 25, 36, 49, 64, and Full-Screen)
- **Change Display Page:** Display Previous or Next Camera in order.
- **Voice Transmission:** Transmit remote voice to the local DVR.

- 
- **Screenshot:** Capture the current screen and save it as an image file.
  - **Sequence:** Display images on pre-selected sites in sequence mode.
  
  - **Setup:** Change the setup of the Transporter Viewer or a remote DVR.
  - **Audio Volume:** Select audio volume and mute options. Select a camera to receive Audio (highlighted borderlines).
  - **Full Screen:** Display image on full-screen mode.
  - **Close:** Close the software

The below options are only selectable under playback mode.

**Calendar Search:** Search data using a graphic calendar and time table.

**Event Search:** Search data using recorded event logs.

**Text-In Search:** Search data using recorded Text-In data from POS/ATM device.



**Backup:** Shows backup options.

- **Save as MP4:** Save the recorded data in MP4 file format.
- **Backup:** Backup the recorded data.



**Storage:** Select a storage type installed in the connected DVR.

Either recording HDD or Archiving HDD can be selected for playback.

## 1-2. Site Set Up

Click **Connect** button to display registered remote locations or add new locations.



Click **Add** button to add remote location with its required information.

The screenshot shows a dialog box titled "Add Site" with the following fields and options:

- Name: TEST DVR
- Address: 111.111.111.111
- Port: 10101
- Description: DVR for TEST
- Auto Login
- User: Administrator (dropdown menu)
- Password: (empty text field)
- Layout: No Change (dropdown menu)

Buttons for "OK" and "Cancel" are at the bottom.

- **Name:** Enter Site Name.
- **Address:** Enter IP address or Domain Name of the Site.
- **Port:** Enter Port Number, if there is a specific port to be set for the software.
- **Description:** Enter a Description of the Site
- **Auto Login:** If do not want the Login window to popup whenever the remote S/W starts, check "Auto Login". This will skip the User/Password authentication process.
- **User:** Select the type of User.
- **Password:** Enter the Password of the DVR.
- **Layout:** Select desired display Layout for the site when it is connected.

**Note:** Using the display option on the menu, Layout can be changed once connected.

Click **OK** to save information and complete the registration. To connect to the site, double click the location or select it and click **Connection** button.



The DVR and the Client Program on the PC begin searching for each other when they are on the same local network. The [Auto Detection] menu displays the DVRs detected on the same local network.

**Note:** This function is only available on local networks. No settings are required, if both DVR and PC use DHCP. However, if Static IPs are used, DVR and PC need to have the same subnet information but different static IP addresses.

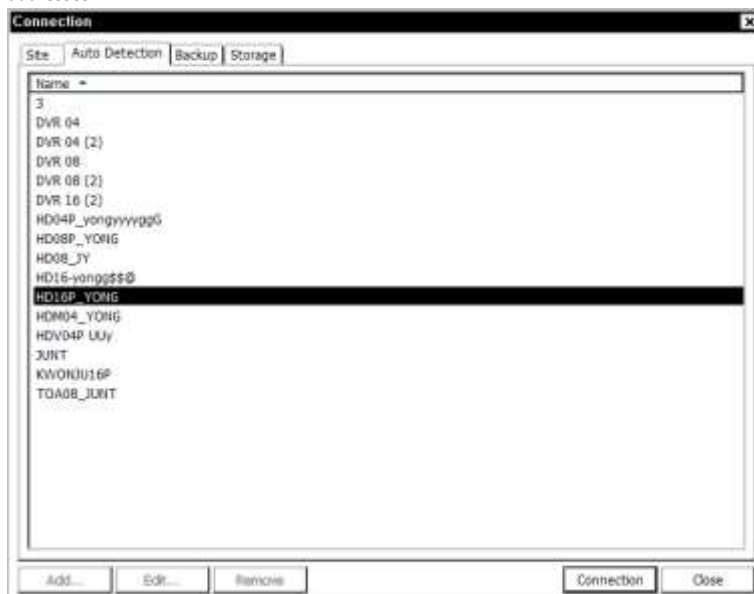

**Note:** [Auto Detection] automatically finds DVRs on the local network. To use this function, Apple® Bonjour® needs to be installed in your PC. Please refer to <http://www.apple.com/bonjour> for more details and download.

### 1-3. Favorite Set Up

[Favorite] function allows multi-site management. Up to 64 different cameras and sites can be monitored and managed on one screen. Select [Favorite] tab.

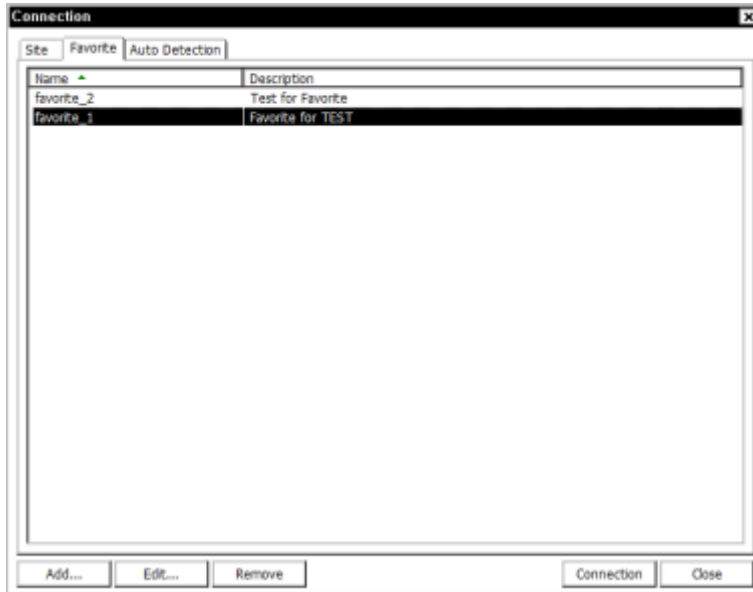

Click **Add** button to group multiple sites as one favorite group.

Enter the Group Name and Description. Up to 64 different cameras or sites can be grouped and displayed together. Select the sites and cameras from the list provided.

**Note:** Before setting the [Favorite], sites should be registered under [Site] menu.

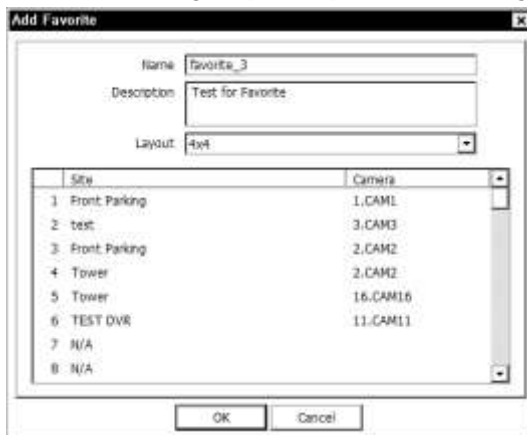

### 1-3. Site List Panel

The remote sites can be registered the on Site List Panel. Use the **ADD** , **EDIT** , **REMOVE** buttons located on the bottom to register and manage the remote sites and favorite sites.

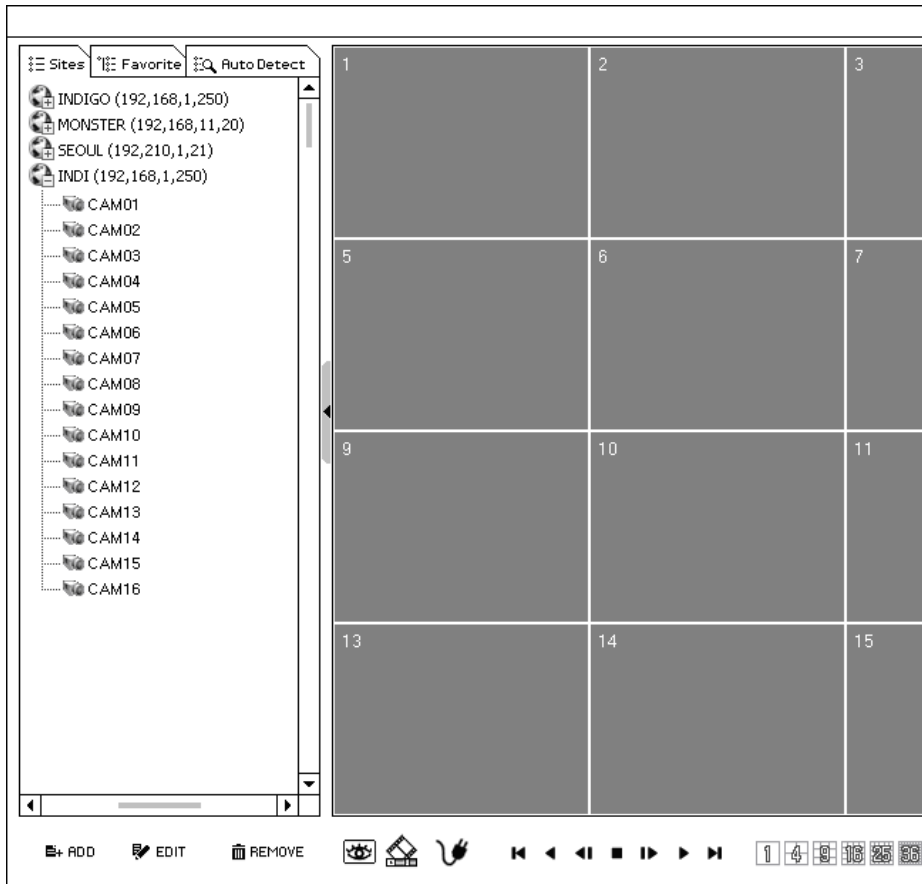

To connect to the sites, Drag and Drop the listed sites and cameras onto the Display Screen. When the different cameras have been arranged on the screen, click the [Favorite] tab to save the arrangement as a new Favorite site.

**Note:** You can exchange or move around Camera Positions with Drag and Drop.



## 1-4. Tool Panel

### 1-4-1. DVR

Site : TEST DVR  
Address : 111.111.111.111  
Description : DVR for TEST  
Version : 1.5.0

CAM 1				
CAM 2				
CAM 3				
CAM 4				
CAM 5				
CAM 6				
CAM 7				
CAM 8				
CAM 9				
CAM 10				
CAM 11				
CAM 12				
CAM 13				
CAM 14				
CAM 15				
CAM 16				

Event Pop-up

[DVR] tab shows Video Loss, Motion Detection, and Sensor Detection statuses of currently connected remote site. User can activate a remote alarm on DVR Status options.



**Reload:** Refresh the latest DVR status info.



**Reset Alarms:** Turn off activated Alarms on the DVR.

**Event Pop-up:** Set "Event Pop-up" option. This option will display a camera in full-screen mode when there is an event. Set Pop-up Duration at *Setup > System > Event Pop-up Duration*.

**Note:** When [DVR] tab is hidden and the other tabs (PTZ Control, Text-In, GPS) are being used, "Event Pop-up" will not be activated even though it is checked.

### 1-4-2. PTZ

Site : TEST DVR  
Address : 111.111.111.111  
Description : DVR for TEST  
Version : 1.5.0

PTZ

— ZOOM +

— FOCUS +

The [PTZ] tab will display the site information and activate the PTZ controllers, when a PTZ camera is connected in Live Mode.



**Set Preset:** Save PTZ camera's current location. Up to 16 Presets can be saved.



**Move to Preset:** Move PTZ camera to the saved location settings.

### 1-4-3. TEXT-IN

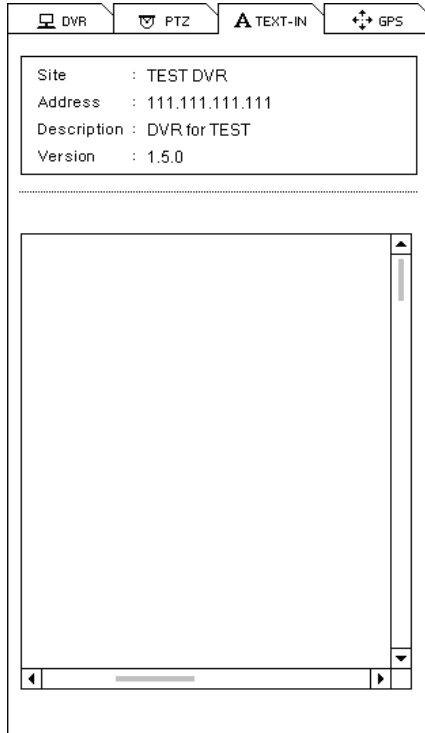

[TEXT-IN] tab displays recorded Text-In information. This tab is activated only under Playback Mode.

### 1-4-4. GPS

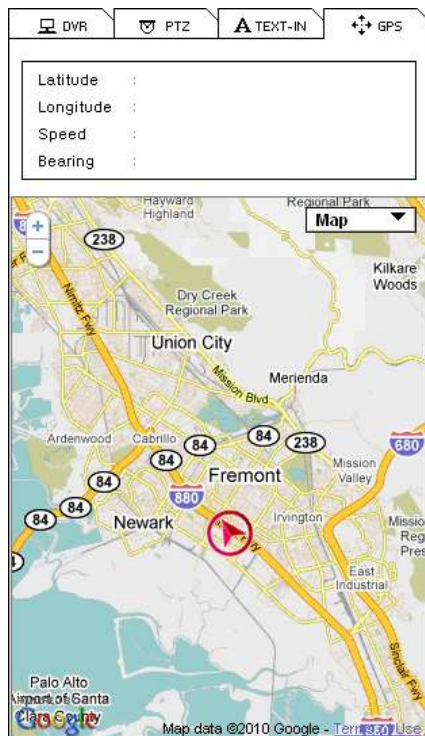

[GPS] tab is used to track Mobile DVR under Playback Mode. GPS data is recorded with images using a built-in GPS on the Mobile DVR. This data will be displayed on Google Map under Playback Mode.

## 2. Remote Playback

### 2-1. Calendar Search

The Calendar Search Panel appears when a site is connected under Playback Mode as shown below. The Time Bar will appear when a date is selected, and the Image Preview will appear when the specific time is selected on the Time Bar.

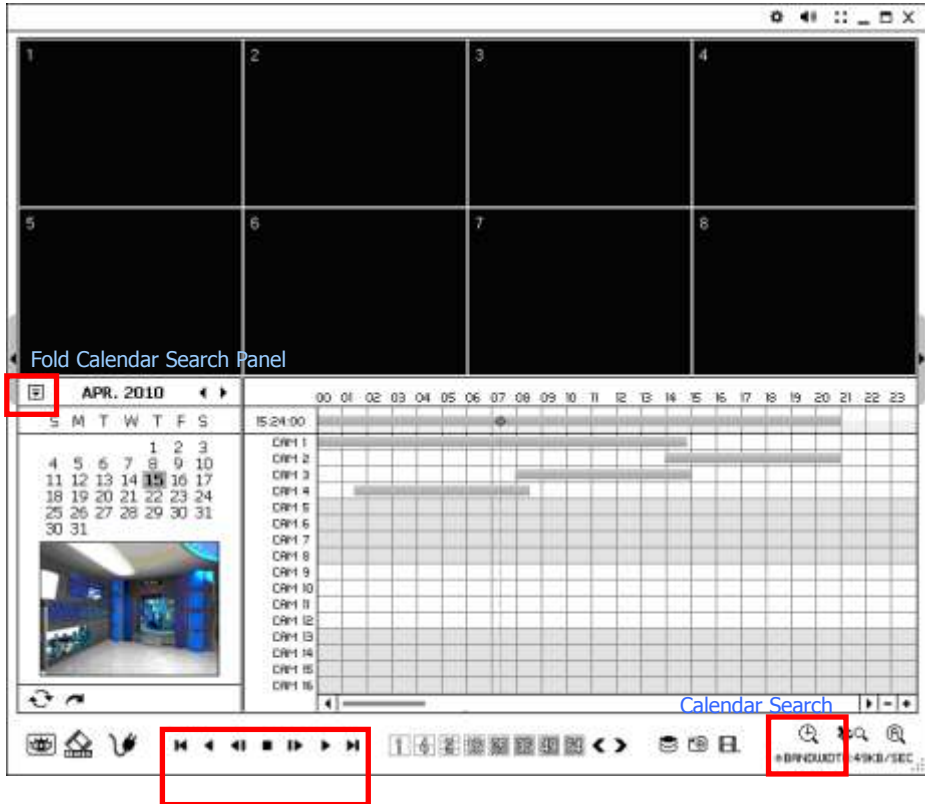



Use **Playback Control Buttons** to control the playback image.

- ⏮ Go to Beginning
- ⏪ Reverse Play / Rewind
- ⏩ Step Backward
- Stop
- ⏩ Step Forward
- ⏩ Play / Fast Forward
- ⏭ Go to End

#### Go To Time

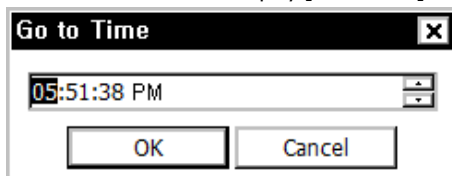
- Click on  icon to display [Go to Time] window. Enter a specific time to search the data.



- Click on  icon to refresh and update the calendar information.

## 2-2. Event Search

Select [Event Search] button located on the bottom of the screen to open EVENT SEARCH Panel. Select Date, Event Type, and Camera; then, click **SEARCH** button to retrieve the Search Results.

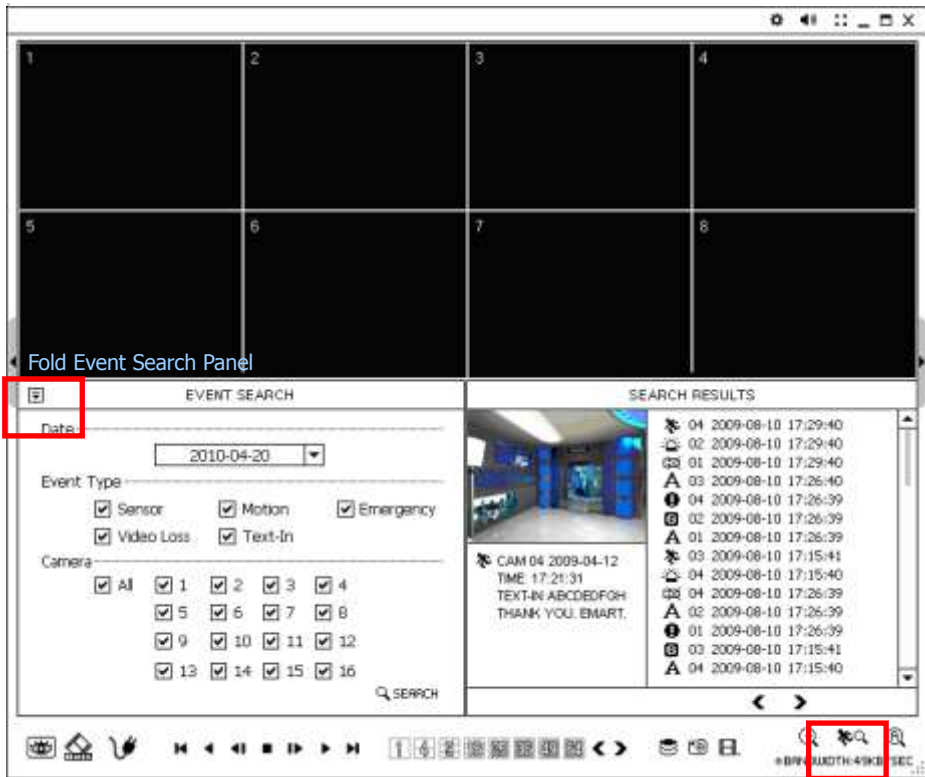

Event Search

Select an event from the [Search Results] list for playback. Search through the list using < > buttons.

Select the date of event search for from the Date list. Select All or specific camera numbers for related event search. Type of events can be selected from the list for detail and effective search.

### 3-3. Text-In Search

Select [Text-In Search] button located on the bottom of the screen to open TEXT-IN SEARCH Panel. Enter Date and Text and select **SEARCH** button to retrieve the Search Results.

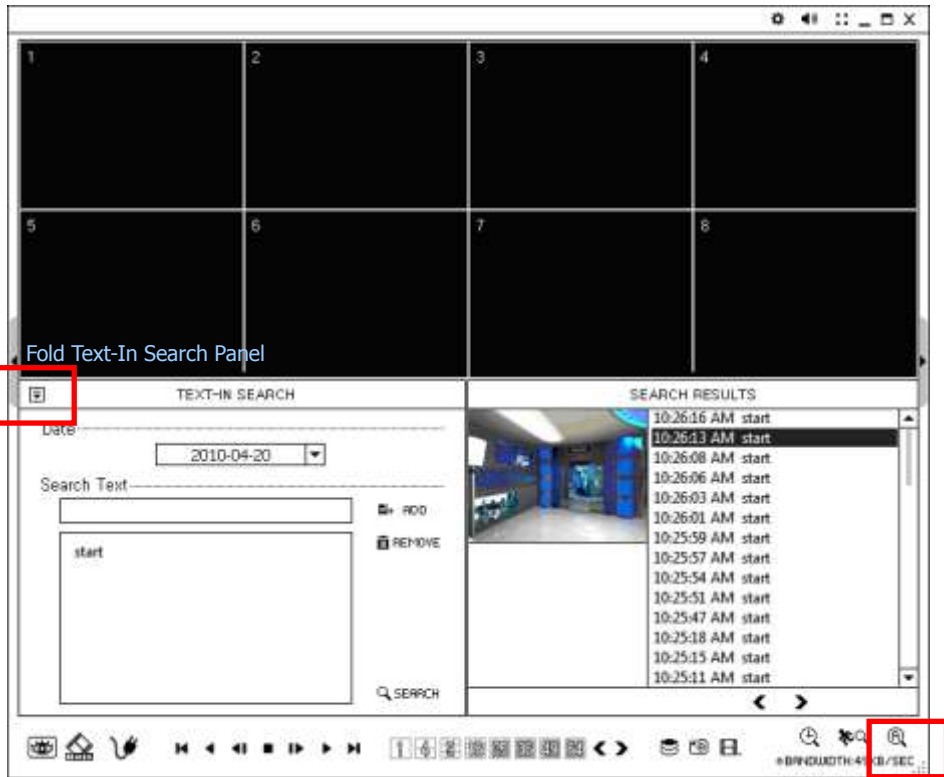

Select a Text-In Event from the list for playback. Search through the [Search Results] using < > buttons.

### 3-4. Saving the Recorded Data

#### Screenshot

Select  button to capture the current image during playback. Select  button to save the image. The Image can be saved in JPEG, BMP and PNG format.



#### Save as MP4

Select  button during playback and select [Save as MP4] to open the window shown below and save data in MP4 format.

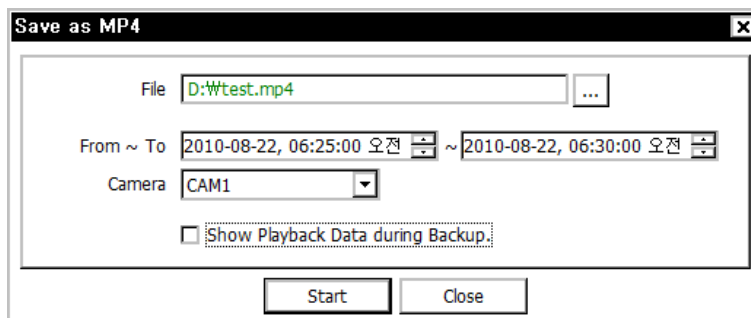

- **File:** Enter file name and select Location.
- **From ~ To:** Select the time period
- **Camera:** Select Camera number. Press Start to create MP4 file.

## Backup

Select  button during playback and select [Backup] to open the window shown below and save the video in the desired video format.

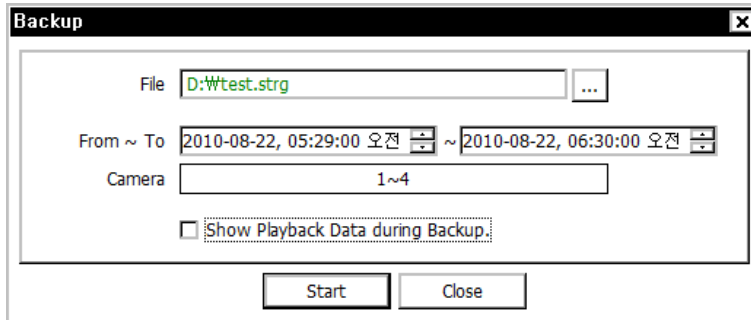

Backup

File: D:\test.strg

From ~ To: 2010-08-22, 05:29:00 오전 ~ 2010-08-22, 06:30:00 오전

Camera: 1~4

Show Playback Data during Backup

Start Close

- **File:** Enter file name and select Location.
- **From ~ To:** Select the time period
- **Camera:** Select Camera number. Press Start to create MP4 file.

## 3-5. Play Backup Data

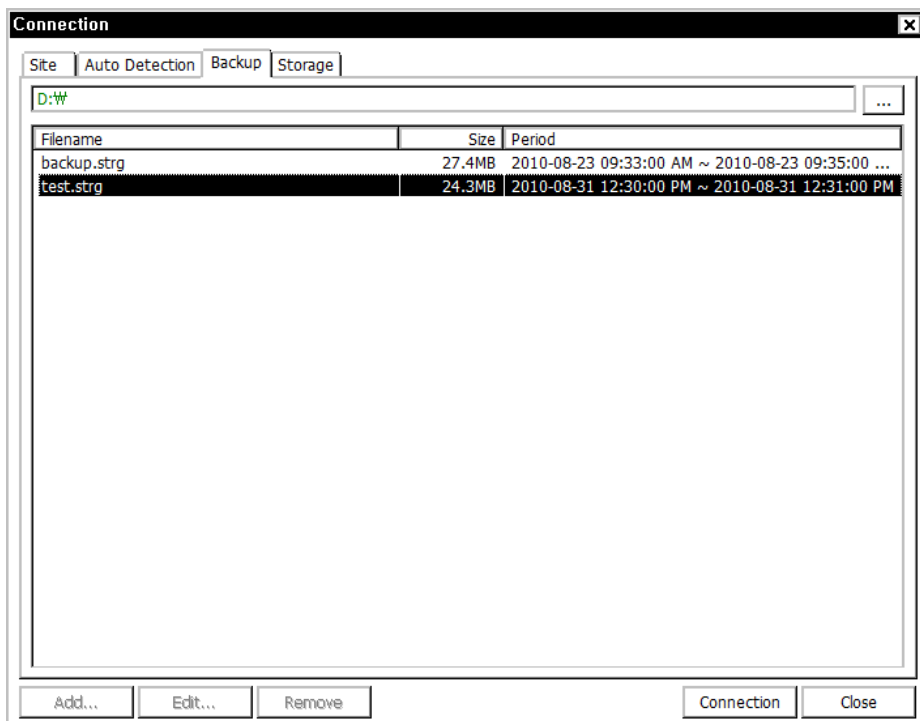

Connection

Site Auto Detection Backup Storage

D:\

Filename	Size	Period
backup.strg	27.4MB	2010-08-23 09:33:00 AM ~ 2010-08-23 09:35:00 ...
test.strg	24.3MB	2010-08-31 12:30:00 PM ~ 2010-08-31 12:31:00 PM

Add... Edit... Remove Connection Close

Data backed up from the local site can be played on the Transporter Viewer software.

Select  button during playback and the above window will appear. Select the location where your data is saved. Select the file you wish to play, and click **Connection** to play the video.

**Note:** Recorded Audio can be played on single screen only.

### 3-6. Play Independent HDD Data on PC

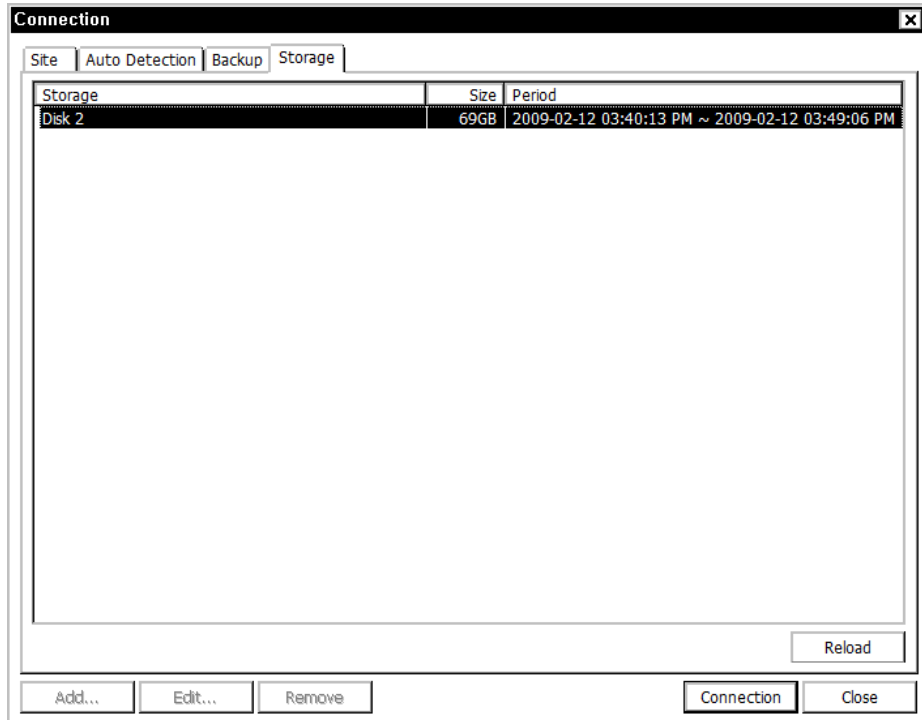

Data from an Independent HDD, removed from a DVR, can be played on the PC using Transporter Viewer Software. Connect the HDD to the PC, using a SATA to USB connector cable. Make sure the HDD is connected to the PC properly.

Select  button during playback. Click [Storage] tab to display HDD information. If HDD is not shown, click **Reload** button to refresh the list. Double click the storage you wish to play, or highlight the storage and click **Connection** button.

**Note:** When connecting the HDD to the PC, please connect both USB connectors to the PC to supply enough power for the HDD. Please look at the following image for a visual reference.





## 4. Setup

### 4-1. Transporter Viewer Setup

Click  and  to enter Transporter Viewer [Setup] Window.

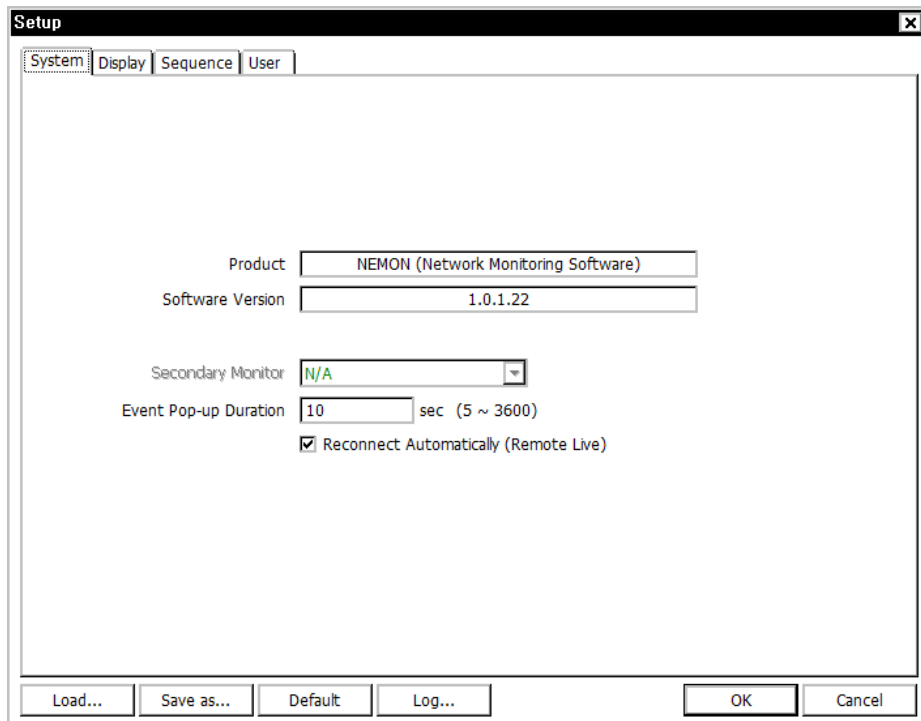

Setup

System | Display | Sequence | User

Product:

Software Version:

Secondary Monitor:

Event Pop-up Duration:  sec (5 ~ 3600)

Reconnect Automatically (Remote Live)

- **Product:** Displays general information of the software.
- **Software Version:** Displays current Software Version.
- **Secondary Monitor:** Select the Secondary Monitor when using more than one monitors on the PC
- **Event Pop-up Duration:** Set the time duration for a camera display, when it is displayed in full screen mode in case of an event.
- **Reconnect Automatically:** Check the box to set automatic reconnection on Live Mode, if the connection were to end.

- **Load...**: Load previously saved remote software settings.
- **Save as...**: Save the current listed settings for the remote software.
- **Default**: Set current settings as the Default settings for the remote software.
- **Log...**: Displays the history of the remote software usage.

Click on [Display] tab to enter display setup menu.

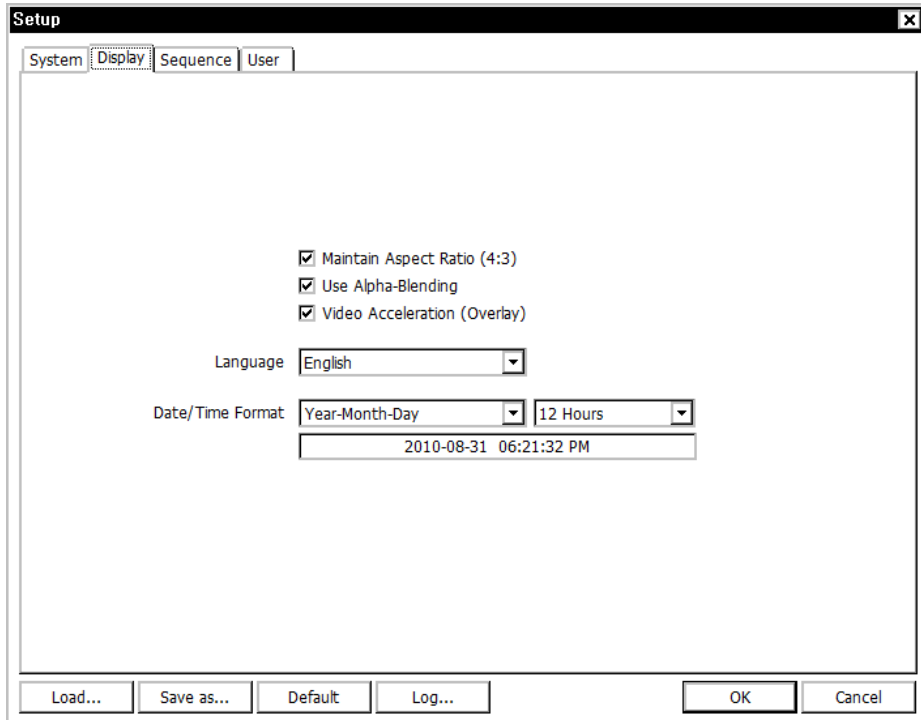

- **Maintain Aspect Ration (4:3):** Check to keep 4:3 display ratio on Transporter Viewer display screen.
- **Use Alpha-Blending:** Enables alpha-blending effect to software UI when checked.
- **Video Acceleration:** Video Acceleration option enhances natural live image display on the client software. Please do not select this option as it may cause improper live image display. Some PC graphic cards do not support this option.

**Note:** There are some graphic cards that do not support such functions. In this case, unselect the option as it might result in abnormal system operation.

- **Language:** Select desired Language for the remote software.
- **Date/Time Format:** Select Date/Time Format for the remote software.

Click on [Sequence] tab to enter sequence setup menu.

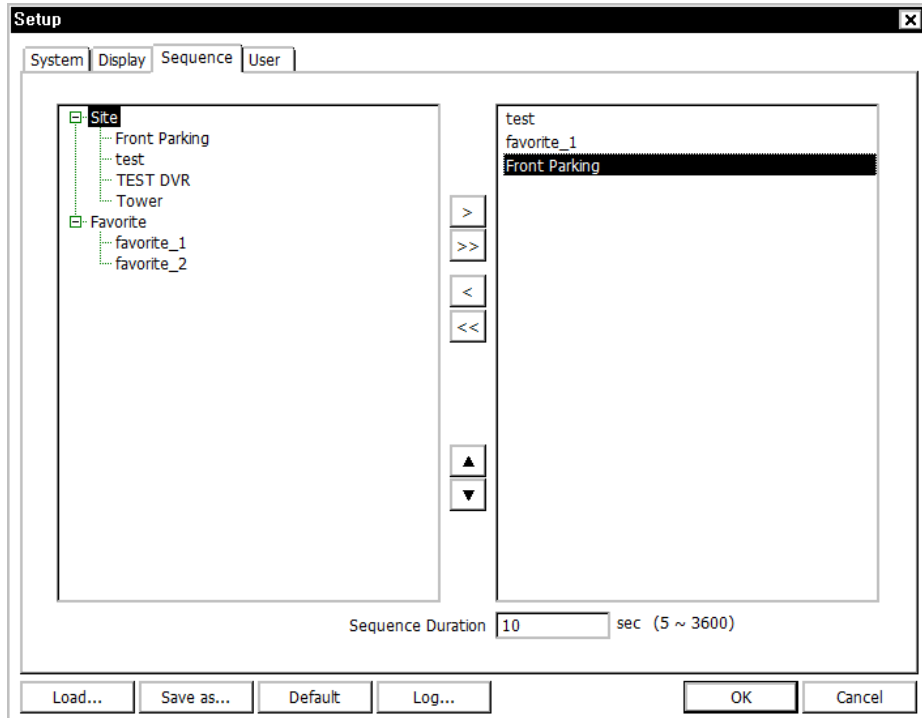

Set sequence mode and sequential sites from registered or Favorite sites. Click the site and select  button to add the site into the sequencing list.  button will move all sites into the sequencing list.

- **Sequence Duration:** Set sequence interval time.

Click on [Use] tab to enter user setup menu.

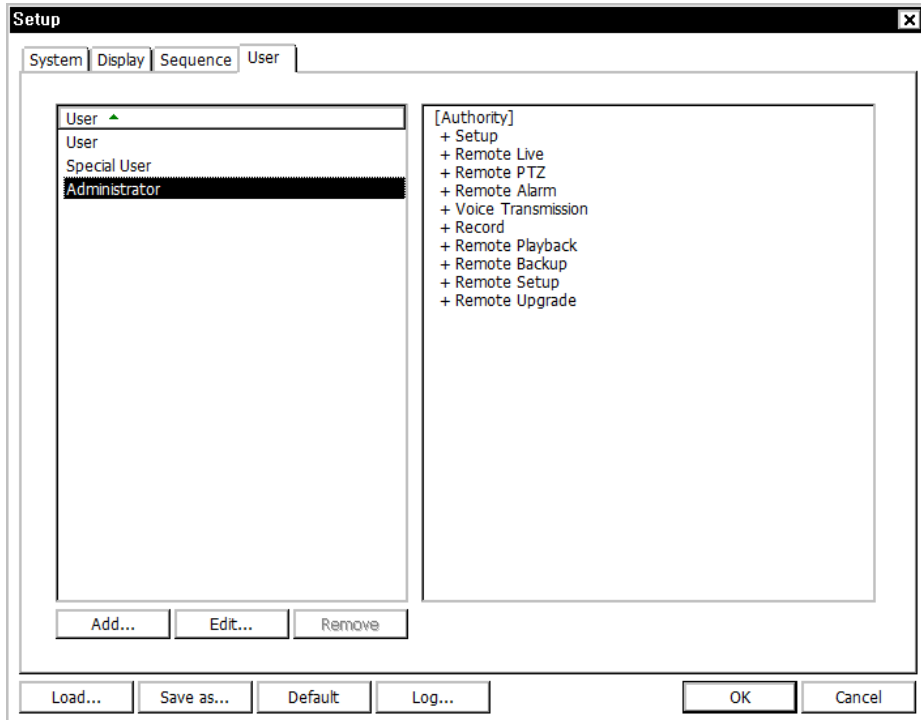

Add Transporter Viewer Software users. Select **Add** to add a new user.

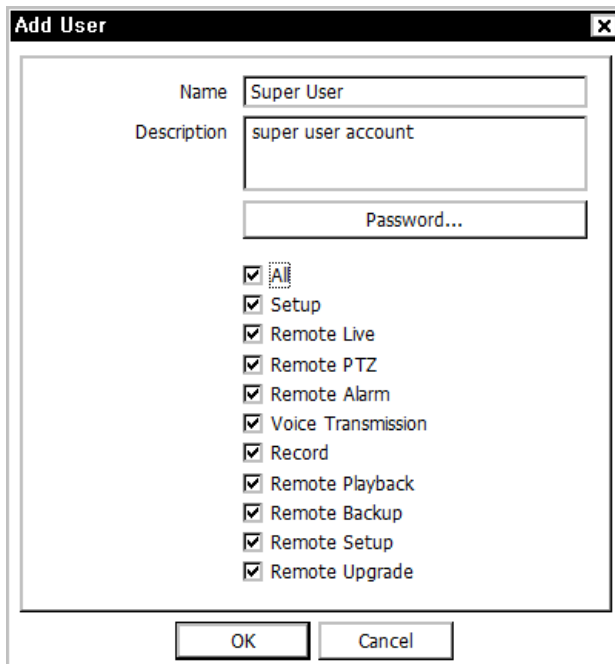

## 4-2. Remote Setup

Click  and [Remote Setup] to enter remote setup menu.

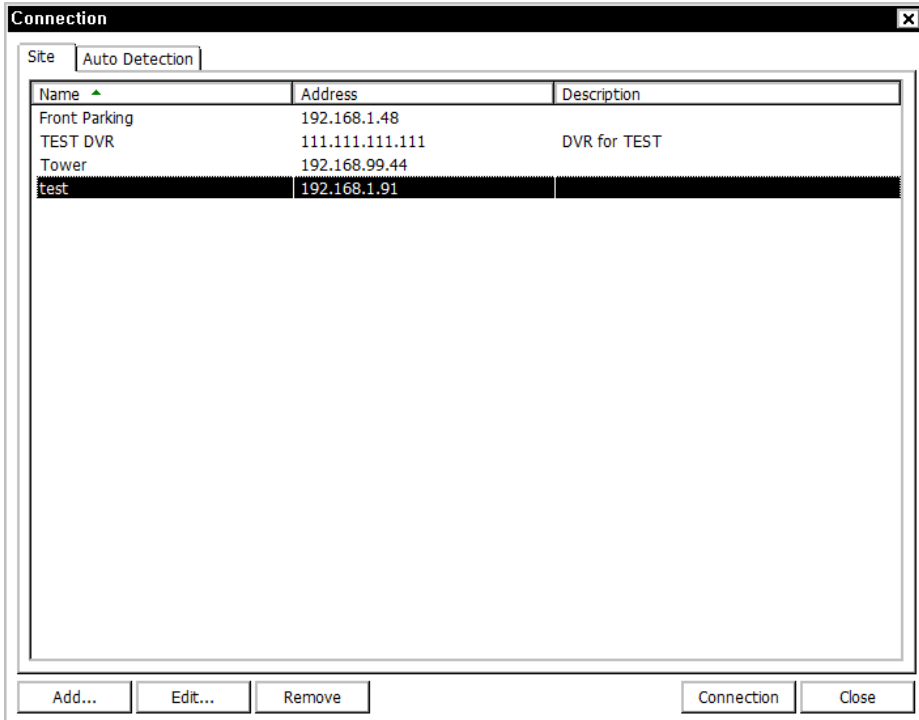

Select a DVR for setup and select **Connection** button. The Setup Menu shown below will appear when it is connected.

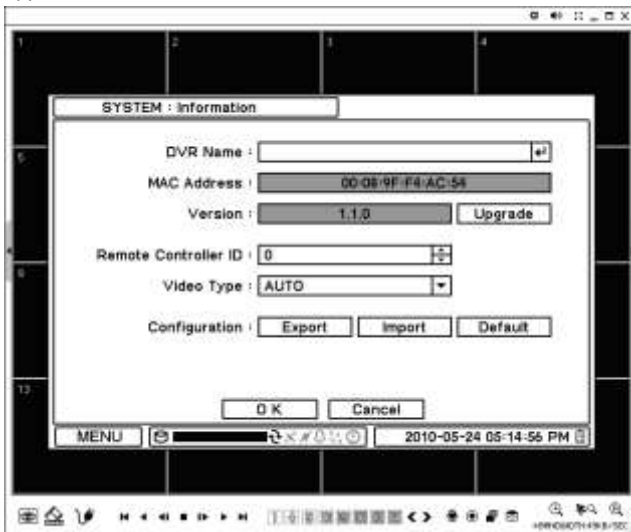

**Note:** The remote software provides interactive system setup that allows local DVR settings from remote sites to be easy. The exact same menu and options as the local system appears for remote sites.

### 4-3. Remote Upgrade

The DVR upgrade can be done through the Transporter Viewer program on the PC.

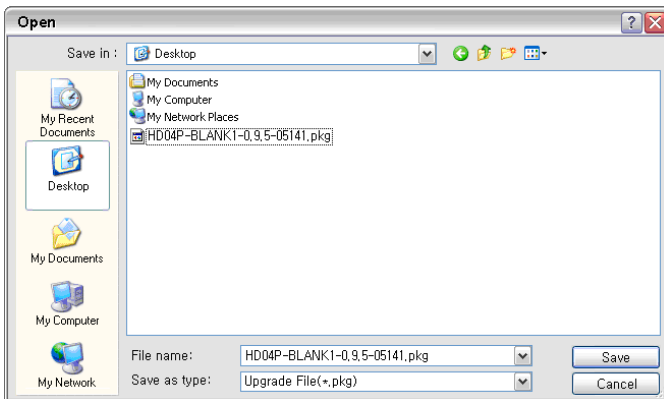
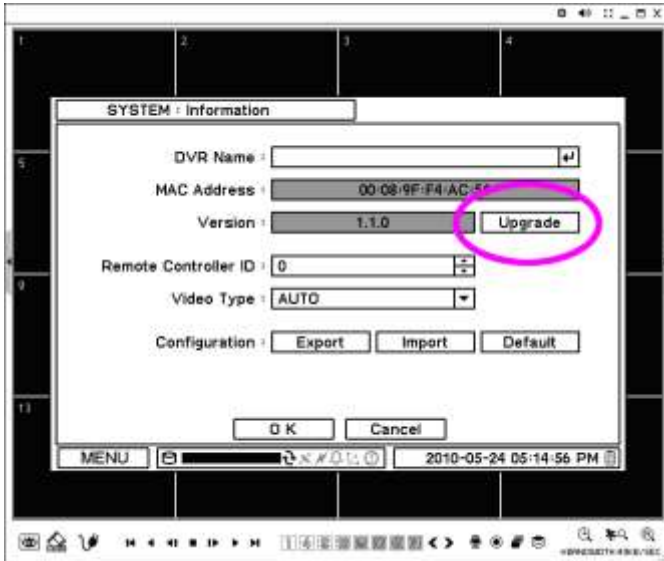

- Click  and [Remote Setup] to enter remote setup menu.
- Select [Information] under System.
- Click **Upgrade** next to the software Version to find a file for upgrade.
- Select the file location and the file to upgrade the system.

**Note:** Please do not close down Transporter Viewer Software or turn the computer power off until the system upgrade is complete.

## 5. Transporter Callback

Start > Program > Transporter > Transporter Callback



"Transporter Callback" icon will be displayed on the bottom right of the taskbar once the program starts. The "Callback" message will display as shown below.

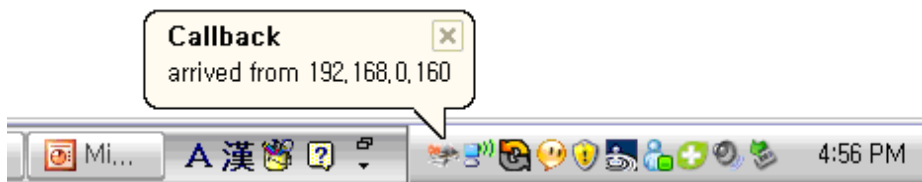

Click "Transporter Callback" icon to display the main window of Callback as shown below.

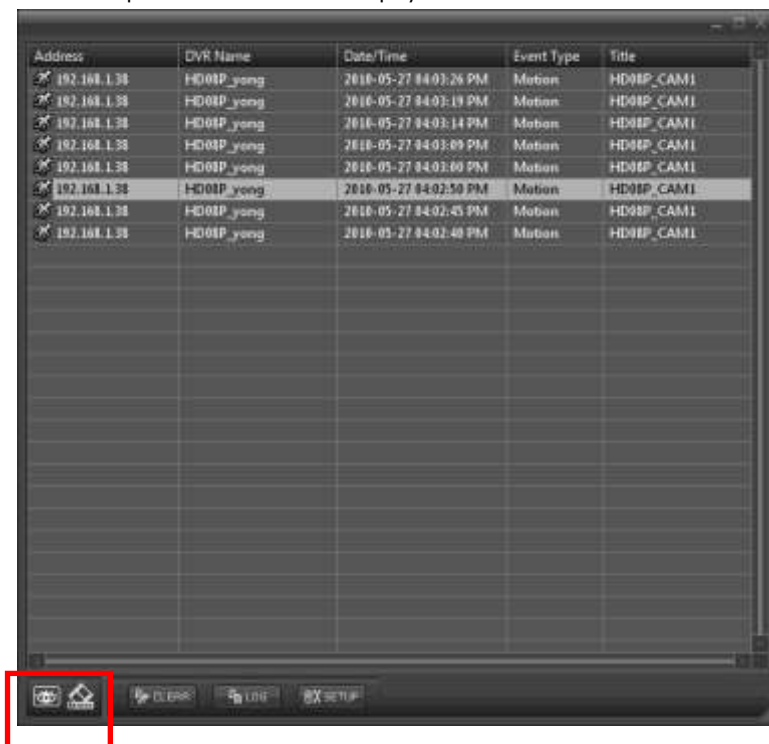

Select a log from the list and click Live or Playback icon image to connect to the related DVR.

- **Clear:** Clear all the logs listed on Transporter Callback Window
- **Log:** Click Log button to display Log window as shown below.

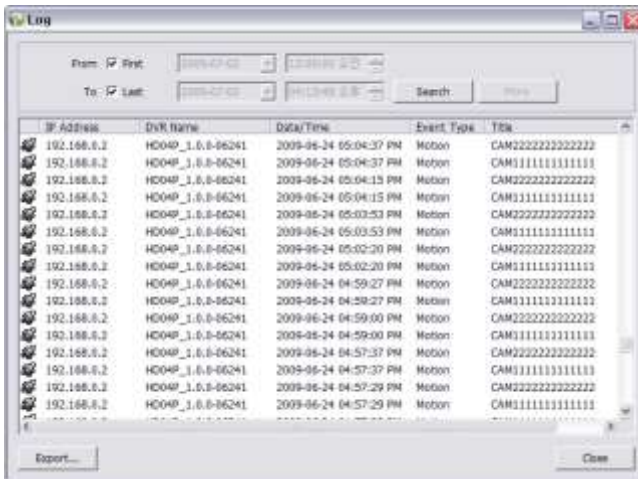

Up to 100,000 Logs can be saved. Only 1,000 logs will be displayed per search. To display the next 1,000 logs, click **More** button. Click **Export** button to save the searched logs in either txt or csv format.

- **Setup:** Click **Setup** button to set a port for Callback. Check "Run Callback at Startup of the System" box to start Callback program automatically when Windows starts.

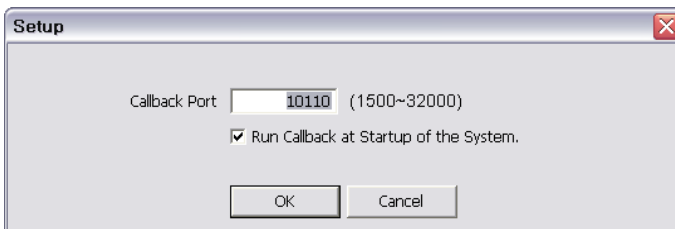

**Note:** If Firewall is being used, UDP port needs to be set to transmit Callback.



---

## Appendix A. Remote Access Using I.E.

The DVR can be accessed remotely using Internet Explorer. Open Internet Explorer and enter the IP address for the DVR to get connected.



Remote Login page will appear, when connected to the DVR. Enter ID, Password, and Port Number. Then, select **Live** or **Playback** button to display the desired remote control option. If Internet Explorer displays an ActiveX installation message, please install ActiveX.



Remote Live



Remote Playback

Please refer to the "Transporter Viewer" Manual, if further instructions on the control options are needed.

**Note:** Remote Access is only supported by Internet Explorer 7.0 or higher.

# Appendix B. Setting DDNS Using Router

Connect with ADSL directly, except when using Public IP.

Please refer to the following Diagram and follow this instructions listed. The diagram is an example of connecting 3 DVRs through a Local Network.

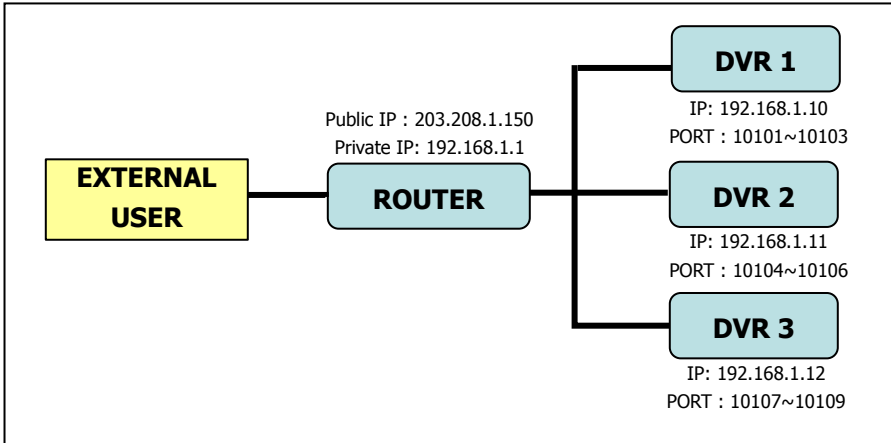

## 1. Domain Name Creation

- Go to [<http://www.dvr-ddns.com/>]
- Click **Sign Up!** to make an Account.



- Fill out the registration information like below.
- Click **Submit** to create the account.



- Enter the desired Domain Name and click **Request Domain** to create the Domain Name.



- You can see the registered Domain Name and the URL [http://dvr1.dvr-ddns.com].

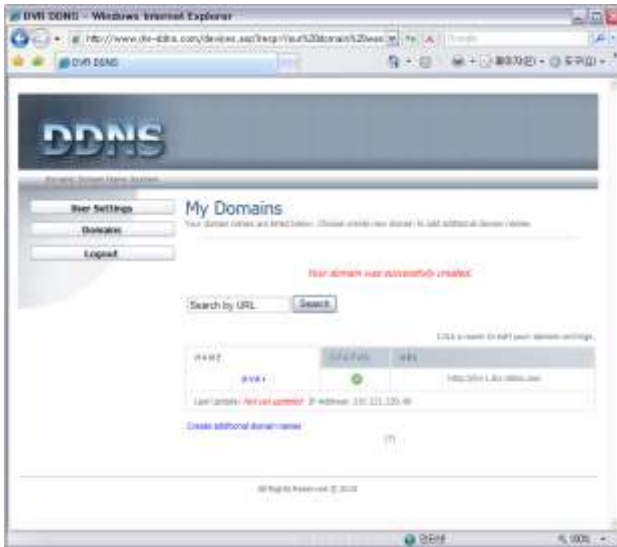

- Up to 3 Domain Names can be created for each account.
- Click the [Create additional domain names] link to create another Domain Name.



## 2. Router Configuration

- Insert the Gateway Address on Internet Explorer to connect to the homepage of the router.
- Click [Port Forwarding] tab. The image below is for the LINKSYS router.

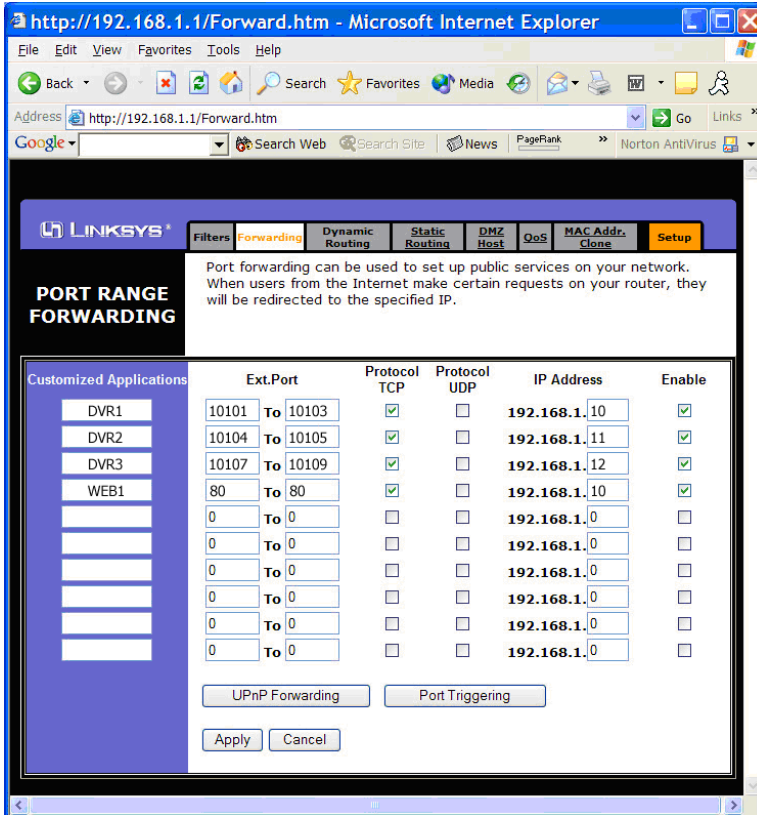

- Please insert the IP Address and Port Number for the DVR in the [Port Forward] menu.
- The Port Numbers listed in this menu make it possible to distinguish each of the DVRs.
- Specify the WEB Port Number to access the DVR with Internet Explorer.
- Default Port Number is 80.

### 3. DVR Configuration

This is an example of DVR Network Setting.

NETWORK : Address

Address Port

Type : Static IP

IP Address : 192 . 168 . 1 . 10

Subnet Mask : 255 . 255 . 255 . 0

Gateway : 192 , 168 . 1 , 1

DNS Server : 8 , 8 . 8 . 8

ID :

Password :

OK Cancel

MENU 99% 2009-12-17 04:49:45 PM

Select Static IP option and fill in the other information accordingly. The system should be allocated with the different IP Addresses.

NETWORK : Address

Address Port

Network Port : 10101 (1500 ~ 32000)

Web Port : 80

	Port
Live	10101
Playback	10102
Setup	10103
Web	80

OK Cancel

MENU 2010-03-23 05:19:59 PM

Set Ports according to the DVR port settings.

NETWORK : DDNS

Use DDNS

DDNS Server : dvr-ddns.com

Hostname : dvr1.dvr-ddns.com

Use ID

ID : test@abc.com

Password :

Update

OK Cancel

MENU 99% 2009-12-17 04:46:30 PM

DDNS can be used, if the system is registered on the DDNS Server. ID and Password are required for the registered server authentication.

---

## COMPLIANCE NOTICE OF FCC:

THIS EQUIPMENT HAS BEEN TESTED AND FOUND TO COMPLY WITH THE LIMITS FOR A CLASS A DIGITAL DEVICE, PURSUANT TO PART 15 OF THE FCC RULES. THESE LIMITS ARE DESIGNED TO PROVIDE REASONABLE PROTECTION AGAINST HARMFUL INTERFERENCE WHEN THE EQUIPMENT IS OPERATED IN A COMMERCIAL ENVIRONMENT. THIS EQUIPMENT GENERATES, USES, AND RADIATES RADIO FREQUENCY ENERGY; AND IF NOT INSTALLED AND USED IN ACCORDANCE WITH THE INSTRUCTION MANUAL, MAY CAUSE HARMFUL INTERFERENCE TO RADIO COMMUNICATIONS. OPERATION OF THIS EQUIPMENT IN A RESIDENTIAL AREA IS LIKELY TO CAUSE HARMFUL INTERFERENCE, IN WHICH CASE USERS WILL BE REQUIRED TO CORRECT THE INTERFERENCE AT THEIR OWN EXPENSE.

WARNING: CHANGES OR MODIFICATIONS NOT EXPRESSLY APPROVED BY THE PARTY RESPONSIBLE FOR COMPLIANCE COULD VOID THE USER'S AUTHORITY TO OPERATE THE EQUIPMENT.

THIS CLASS OF DIGITAL APPARATUS MEETS ALL REQUIREMENTS OF THE CANADIAN INTERFERENCE-CAUSING EQUIPMENT REGULATIONS.

---

## WEEE (Waste Electrical & Electronic Equipment)

**Correct Disposal of This Product** (Applicable in the European Union and other European countries with separate collection systems)



This marking shown on the product or its literature, indicates that it should not be disposed with other household wastes at the end of its working life. To prevent possible harm to the environment or human health from uncontrolled waste disposal, please separate this from other types of wastes and recycle it responsibly to promote the sustainable reuse of material resources.

Household users should contact either the retailer where they purchased this product, or their local government office, for details of where and how they can take this item for environmentally safe recycling.

Business users should contact their supplier and check the terms and conditions of the purchase contract. This product should not be mixed with other commercial wastes for disposal.

---

## ROHS Compliance

