

# PIXIM Bullet Camera

**DWC-B1365T**



 **PIXIM**

## **ABOUT MANUAL**

Before installing and using the camera, please read this manual carefully.  
Be sure to keep it handy for future reference.

## PRECAUTIONS

---

- Do not open or modify.
- Do not open the case except during maintenance and installation, for it may be dangerous and can cause damages.
- Do not put objects into the unit.
- Keep metal objects and flammable substances from entering the camera.  
It can cause fire, short-circuits, or other damages.
- Be careful when handling the unit.
- To prevent damages, do not drop the camera or subject it to shock or vibration.
- Do not install near electric or magnetic fields.
- Protect from humidity and dust.
- Protect from high temperature.
- Be careful when installing near the ceiling of kitchen or a boiler room, as the temperature may rise to high levels.
- Cleaning:  
To remove dirt from the case, moisten a soft cloth with a soft detergent solution and wipe.
- Mounting Surface:  
The material of the mounting surface must be strong enough to support the camera.

## FCC COMPLIANCE

---

This equipment has been tested and found to comply with the limits for a Class B digital device, pursuant to part 15 of the FCC rules. These limits are designed to provide reasonable protection against harmful interference, when the equipment is operated in a residential environment. This equipment generates, uses, and radiates radio frequency energy; and if it is not installed and used in accordance with the instruction manual, it may cause harmful interference to radio communications.

**WARNING:** Changes or modifications are not expressly approved by the manufacturer.

## TABLE OF CONTENTS

---

<b>Introduction</b> .....	Features .....	4
	Parts and Descriptions .....	5
	Dimensions .....	6
<b>Installation</b> .....	Inside the Box .....	7
	Mount Installation Instructions .....	8
	Connecting to Monitors .....	9
	Control Board .....	10
	Adjusting the Camera Lens .....	11
	Adjusting the Camera Angle .....	12
<b>Module OSD Menu</b> .....		13-24
<b>Troubleshooting</b> .....		25
<b>Warranty Information</b> .....		26-27
<b>Specifications</b> .....		28-29

## FEATURES\*

- 1/3" PIXIM Seawolf CMOS Sensor
- 690 Horizontal TV Lines
- 3.3~12mm Varifocal Auto Iris Lens
- TDN (True Day and Night/IR Cut Filter)
- 3D-DNR (3D Digital Noise Reduction)
- Powerful Wide Dynamic Range
- Ultra Low Light Sensitivity
- Smear Canceling Circuit
- AGC / BLC / AWB
- Programmable Privacy Zones (6) & Motion Detection
- OSD Menu with Built-in Joystick
- IP66 Certified (Weatherproof)
- No Fog or Condensation under Any Weather Condition
- Auto Sensing 12VDC/24VAC with Line Lock
- Secondary Video-BNC Output
- Ball Neck Bracket (Simple Camera Positioning)
- External Lens and OSD Control

## PARTS & DESCRIPTION\*

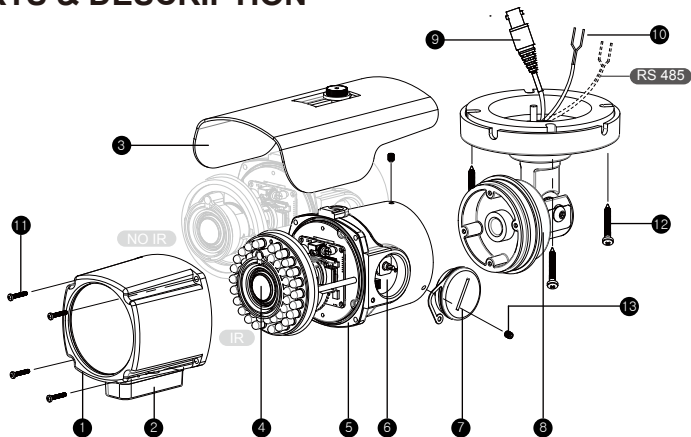

- 1 Front Case
- 2 Zoom & Focus Housing
- 3 Sunshield
- 4 Lens
- 5 Rear Case
- 6 Control Board
- 7 Control Cap

- 8 Double Arm Bracket
- 9 Second Video-BNC Output Connector
- 10 Power Input Connector (Dual Voltage)
- 11 Assembly Screw
- 12 Mounting Screw
- 13 Set Screw

## DIMENSIONS IN MILLIMETERS (IN)\*

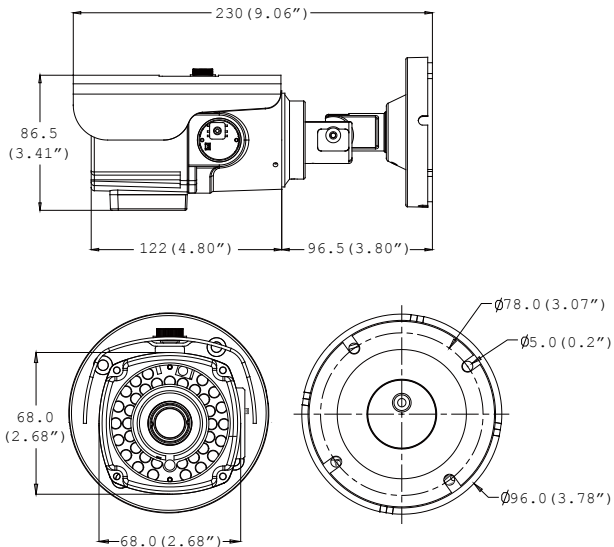

## INSIDE THE BOX\*

### Included with B1 Bullet Camera

- 1 User Manual
- 2 Mounting Template
- 3 4 Machine Screws and 4 Dry Wall Anchors
- 4 Secondary Video-BNC Cable
- 5 L-Key
- 6 Double-Sided TORX-T20 Hex Key



1

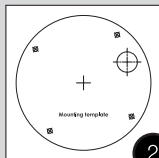

2

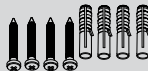

3



4



5



6

# SURFACE MOUNT INSTALLATION INSTRUCTIONS\*

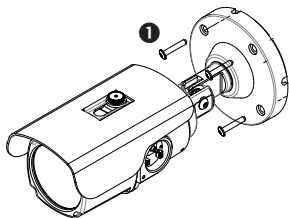

- 1 Use the 4 mounting screws to install the camera on the wall or ceiling.

Then, follow the next step on pages 9-12.

\*Installation Using a Junction Box

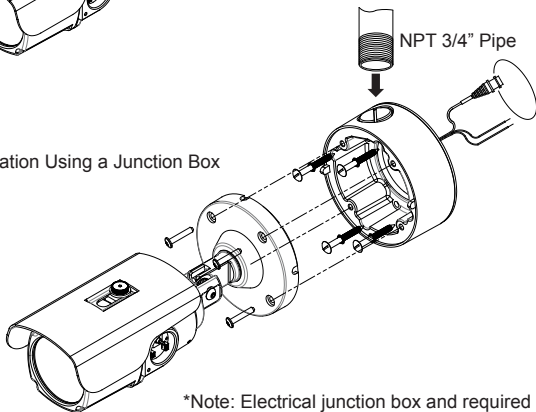

\*Note: Electrical junction box and required screws are sold separately.



## CONNECTING TO MONITORS\*

Use the diagram below to connect to a Monitor or CRT Monitor properly.

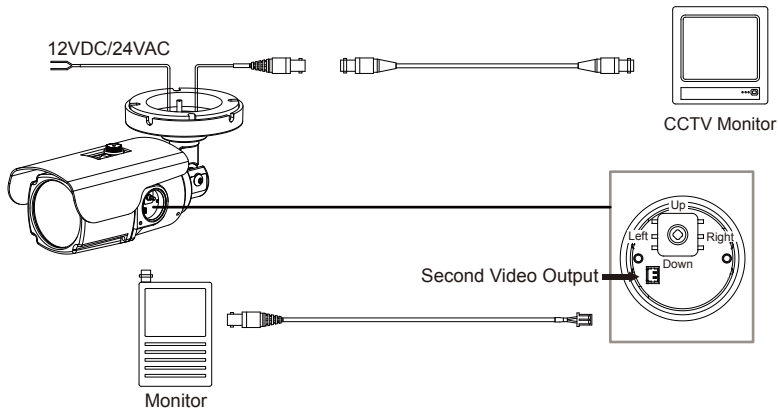

- Power Connection - 12VDC/24VAC Dual Voltage (Auto Polarity Detection and Protection)
- All cameras are equipped with a second video output for on-site configuration.

## CONTROL BOARD\*

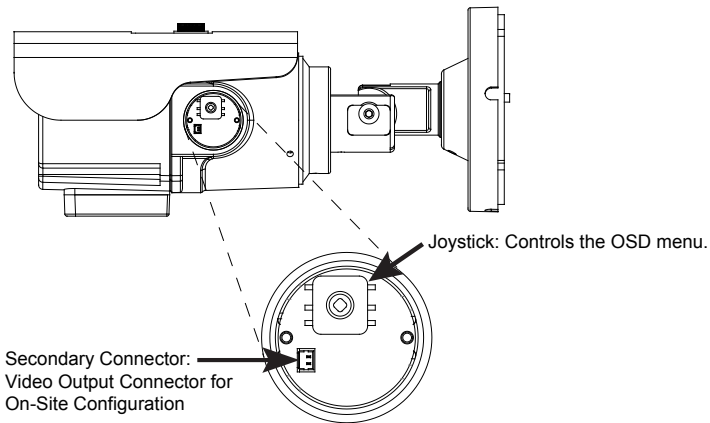

- 1 Remove clear plastic ring from the control cap.
- 2 Turn control cap counter-clockwise until cap separates completely from the camera body.

## ADJUSTING THE CAMERA LENS\*

Follow the instructions provided below to make any lens adjustments.

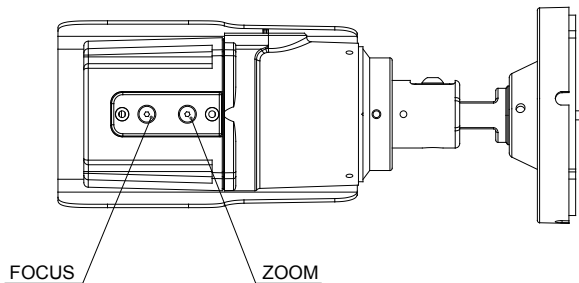

- 1 To adjust the field of view, use the L-Key to turn the zoom screw (located on the bottom of the camera) counter-clockwise to zoom in, or clockwise to zoom out.
- 2 Adjust the focus the same way as described above AFTER the desired zoom position is established.

## ADJUSTING THE CAMERA ANGLE\*

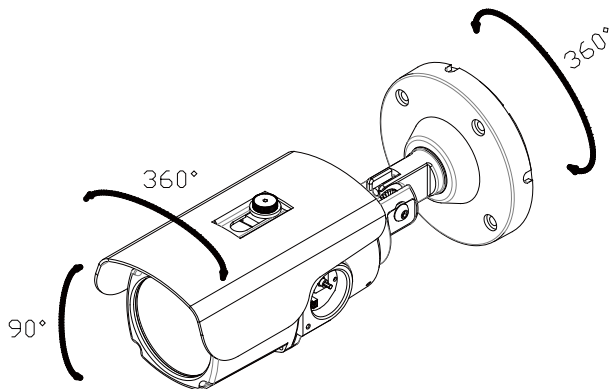

### CAUTION :

- 1 Do not rotate more than 360°.
- 2 Do not unnecessarily twist too many times.

# MODULE OSD MENU\*

EXPOSURE (EXP)	COLOR (RGB)	DAY NIGHT (D&N)	FUNCTION (FUN)
<ul style="list-style-type: none"> <li>— LENS MANUAL / DC</li> <li>— AE PREFERENCE OUTDOOR / INDOOR</li> <li>— BLC OFF / ON</li> <li>— WDR LOW / NORMAL / MEDIUM / HIGH / CUSTOM</li> <li>— AGC LOW / MEDIUM / HIGH</li> <li>— STARLIGHT OFF 2X 30FPS ~ X64</li> <li>— METER ZONE ADJUST ZONE1 / ADJUST ZONE2</li> <li>— EXIT JUMP SAVE &amp; EXIT / EXIT</li> </ul>	<ul style="list-style-type: none"> <li>— WB MODE AWC / ATW / PUSH LOCK / MANUAL</li> <li>— COLOR GAIN 4 ~ 8</li> <li>— EXIT JUMP SAVE &amp; EXIT / EXIT</li> </ul>	<ul style="list-style-type: none"> <li>— D&amp;N MODE AUTO / COLOR / BW</li> <li>— BW BURST OFF / ON</li> <li>— EXIT JUMP SAVE &amp; EXIT / EXIT</li> </ul>	<ul style="list-style-type: none"> <li>— MIRROR OFF / MIRROR / V-FLIP / ROTATE</li> <li>— SHARPNESS 3 ~ 8</li> <li>— GAMMA 25(0.25) ~ 100(1.0)</li> <li>— 3DNR OFF / LOW / MEDIUM / HIGH</li> <li>— D-ZOOM ZOOM / PAN / TILT</li> <li>— EXIT JUMP SAVE &amp; EXIT / EXIT</li> </ul>
MOTION (MOT)	PRIVACY (PRI)	SYNC (SYC)	SETUP (SET)
<ul style="list-style-type: none"> <li>— MOTION OFF / ON</li> <li>— MOTION ZONES 1 / 1-2 / 1-3 / 1-4 ADJUST ZONE 1 ADJUST ZONE 2 ADJUST ZONE 3 ADJUST ZONE 4 RETURN</li> <li>— EXIT JUMP SAVE &amp; EXIT / EXIT</li> </ul>	<ul style="list-style-type: none"> <li>— PRIVACY MASK OFF / ON (AREA 1-6) RETURN</li> <li>— MASK COLOR WHITE / BLACK / RED</li> <li>— EXIT JUMP SAVE &amp; EXIT / EXIT</li> </ul>	<ul style="list-style-type: none"> <li>— INT 1</li> <li>— INT 2 OFF / AUTO</li> <li>— LL LL LIMIT (0.25% / 0.50% / 1.00% / 5.00%) V PHASE(0-624) RETURN</li> <li>— EXIT JUMP SAVE &amp; EXIT / EXIT</li> </ul>	<ul style="list-style-type: none"> <li>— PC CONTROL CAM ID(1-255) / PROTOCOL / BAUDRATE / RETURN</li> <li>— TITLE OFF / ON</li> <li>— LANGUAGE ENGLISH / DEUTSCH / FRANCAIS / ITALIAN / ESPANOL / DUTCH</li> <li>— OMNI LENS ALARM / READ TIEM / ALARM ZOOM / STAND BY / RETURN</li> <li>— FLUORESCENT OFF / CR1 / CR2</li> <li>— DIGITAL VIDEO OUTPUT DIGITAL OUT / FIELD ORDER / FRAME RPT / RETURN</li> <li>— EXIT JUMP SAVE &amp; EXIT / EXIT</li> </ul>
EXIT (EXT)			
<ul style="list-style-type: none"> <li>— EXIT SAVE &amp; EXIT FACTORY SET</li> </ul>			



## EXPOSURE (EXP)

### LENS

MANUAL: Manual iris or Fixed board lens.

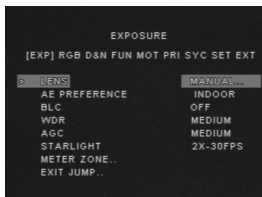

FOCUS METER helps you to find the clear focus. When the dark line aligns with the gray bar, the camera will be adjusting the focus. When it's set on the maximum, you get the clear image.

DC: Auto-iris Varifocal lens.

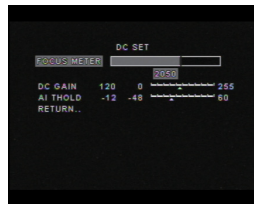

- Set the lens Focus Meter to maximum (See above for more information).
- DC GAIN is to adjust Iris speed. **0 ~ 255**. It is recommended to set the AUTO Gain to 120.
- AI THOLD is to define gain level. **-48 ~ 60**.



## EXPOSURE (EXP)

### AE PREFERENCE

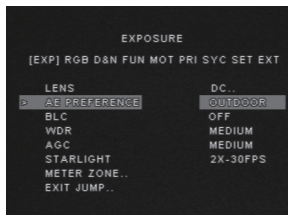

#### Auto Exposure

Set AE PREFERENCE depending on the environment in which the camera is installed. Select from the following options:

INDOOR / OUTDOOR

**BLC** Backlight compensation prevents subjects in defined areas from appearing too dark when backlighting is present. If BLC is enabled, adjust the SHADOW GAIN as desired.

SHADOW GAIN (10~50) The higher the number, the stronger the BLC masking.

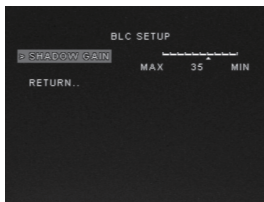
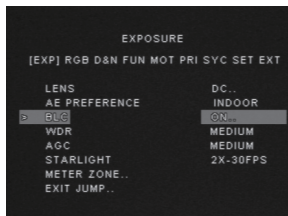



## EXPOSURE

### WDR (Wide Dynamic Range)

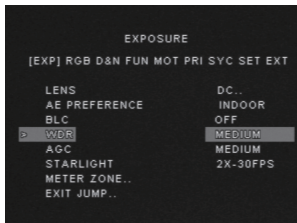

Enables the camera to capture clear images in the same frame, even when there are both very bright and very dark areas in the same field. Select from the following options:

LOW / NORMAL / MEDIUM (Factory Default) / HIGH / CUSTOM

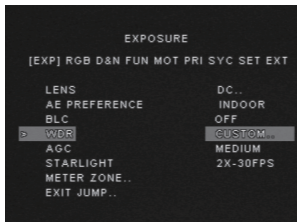

If CUSTOM is selected, adjust the Bias / Limit as you wish.

- BIAS (-30~30): Decide the WDR level in the range of LIMIT. The higher the number, the stronger the WDR adjustment.
- LIMIT (0~36): Decide the range of WDR effect level. 0 means WDR is OFF. The higher the number, the stronger the WDR will be.





## EXPOSURE (EXP)

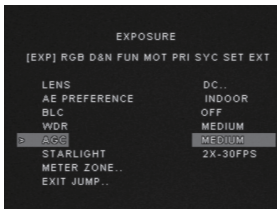

### AGC (Auto Gain Control)

Auto Gain Control automatically adjusts the video gain to enhance picture brightness in low light conditions. The higher number the better sensitivity. However, higher settings mean more digital noise in the image. Select one of the options.

LOW / MEDIUM / HIGH(Factory Default)

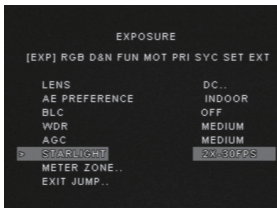

### STARLIGHT

Starlight mode automatically activates slow shutter function when the image is too dark. You can adjust the frame integration level from **X2-30FPS ~ X64\*\***. x2 - 30FPS is the default.

**\*\*Note: Increase the setting may cause the image to lag.\*\***



## EXPOSURE (EXP)

### METER ZONE

Defines an area in the image where the AE and WB settings will be applied. This option is useful when a camera is installed in an environment such as an ATM.

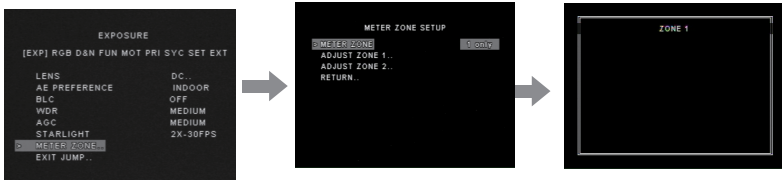

You can setup up to two (2) zones.

1. Select the zone you wish to adjust and enter edit mode.
2. The zone's borders will appear in white. Use the camera's joystick controller to move the zone across the image. When the zone's desired position is achieved, press the joystick controller.
3. The zone's borders will appear in green. Use the camera's joystick controller to increase the size of the zone.
  - a. Moving the joystick to the right will move the zone's **right** border further to the right.
  - b. Moving the joystick to the left will move the zone's **left** border further to the left.
  - c. Moving the joystick up will move the zone's **top** border further up.
  - e. Moving the joystick down will move the zone's **bottom** border further down.
4. Press the joystick again. The zone's borders will appear red. Use this option to reduce the size of the zone.
  - a. Moving the joystick to the right will move the zone's **left** border further to the right.
  - b. Moving the joystick to the left will move the zone's **right** border further to the left.
  - c. Moving the joystick up will move the zone's **bottom** border further up.
  - e. Moving the joystick down will move the zone's **top** border further down.
5. To exit edit mode, press & hold the camera's joystick controller for three (3) seconds.

### EXIT\_JUMP

Go to the Exit menu to save & exit, or exit without saving



## COLOR (RGB)

### WB MODE

Select on of the options:

**AWC** - Auto White Balance Control mode compensates for color temperature changes between 2000K and 18000K.

**ATW**- Auto Tracking White Balance Control mode compensates for color temperature changes between 2500K and 9500K. It is recommended to set the low level to 2.5K, and the high tp 11K.

**PUSH LOCK**- Pushlock is to fix the white balance based on current lighting.

**MANUAL\*\***- Users can control the white balance manually by changing RED GAIN and BLUE GAIN (see below).

**KELVIN (2K~11K)**- The color temperature level that will trigger the AWB.

The lower the number, the cooler the image will appear.

The higher the number, the warmer the image will appear.

**R-GAIN (-20~20)** Adjusts the amount of red in the image.

The higher the number, the image will appear red.

The lower the number, the image will appear green.

**B-GAIN (-20~20)**- Adjusts the amount of blue in the image.

The higher the number, the image will appear blue.

The lower the number, the image will appear yellow.

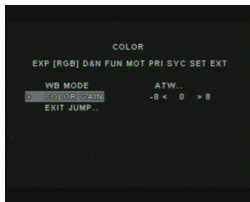
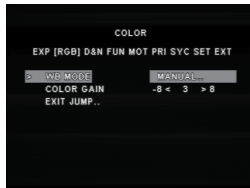

### COLOR GAIN

It's to adjust the amount of color in the image.

-8 (complete B/W) ~ 8 (Full Color)  
(Factory setting is 0.)

### EXIT\_JUMP

Go to the Exit menu to save & exit, or exit without saving

**\*\*All user properties will be written to ROM.\*\***



## DAY NIGHT (D&N)

### D&N MODE

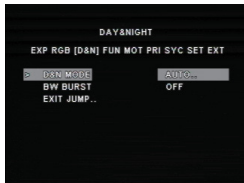

**AUTO** If AUTO is selected, the camera will automatically switch between color and B/W depending on the levels of light available. The camera will stay in color mode when there is enough light. The camera will switch to B&W at night or other low light environments. Please define the following settings:

**READ TIME (3~255):** Time interval delay before switching from day mode to night mode. It is adjustable from 3 seconds to 255 seconds.

**S LEVEL (Color -> B/W) (0~60):** Adjusts the light level at which the camera switches from day (color) to night (B&W) mode. The higher the number, the lower the light level.

**E LEVEL (B/W -> Color) (0~60):** Adjusts the light level at which the camera switches from night (B&W) to day (color) mode. This number should be lower than the value of COLOR->B&W above.

**BW AGC (0~60):** You can fix the Gain levels when the camera switches between Color and B/W.

### BW BURST\*\*

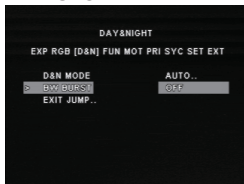

**COLOR** Camera always stays in day mode.  
**BW** Camera always stays in night mode.  
**OFF** Remove BURST when converting to B/W.  
**ON** Output BURST when converting to B/W.

### EXIT\_JUMP

Go to the Exit menu to save & exit, or exit without saving

**\*\*BW BURST available only if Day/ Night Mode is set to AUTO.\*\***



## FUNCTION (FUN)



### MIRROR

Flips the image horizontally / vertically or both(rotate).

OFF / MIRROR / V-FLIP / ROTATE

### SHARPNESS

-8~8 (-4 Default)

Sets the image's sharpness. The higher the number, the sharper lines and details will appear in the image.

However, the sharper the image, the more digital noise will be visible.

### GAMMA

Select the desired gamma level.

25~100 (45 is default.)

### 3D-DNR

#### (Digital Noise Reduction)

3D-DNR reduces the noise on the screen in low light conditions and allows for clearer images, even at night.

Select from the following options:

OFF / LOW / MEDIUM / HIGH

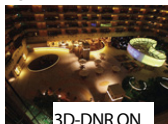
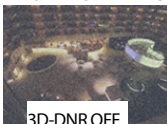

### D-ZOOM

The digital zoom function zooms to the center of the image by default. Set the Zoom level from 1~ X8.

This menu also allows you adjust the camera's Pan and Tilt.\*\*

### EXIT\_JUMP

Go to the Exit menu to save & exit, or exit without saving

**\*\*Note: Pan & Tilt Setup options are disabled for this camera module.\*\***



## MOTION (MOT)

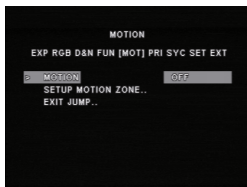

### MOTION

The camera can detect the movement and display an alarm on the screen when movement is detected.

#### OFF / ON

If Motion is enabled, you can setup the **ACTIVITY THRESHOLD**. This setups the camera's sensitivity to movement. The higher the number the camera will be more sensitive to smaller movements. Select from 0 ~ 255.

When motion is enabled, "ALARM!" will appear on the top right-hand corner of the screen when the camera detects motion.

### SET MOTION ZONE

Select from four (4) available zones. To display them, select :

- 1 Zones- Activate only the first zone.
- 1-2 Zones- Activat zones 1 & 2.
- 1-3 Zones- Activate zones 1, 2, & 3.
- 1-4 Zones- Activate all zones.

To edit a motion zone:

1. Select the zone you want to setup. The selected zone's botrders will appear in white.
2. Using your joystick, move the zone to the desired area.
3. Press the joystick to adjust the zone's size. The zone's borders will be green.
  - a. Move the joystick to the right to move the zone's right border further to the right.
  - b. Move the joystick to the left to move the zone's left border further to the left.
  - c. Move the joystick up to move the zone's top border further up.
  - e. Moving the joystick down will move the zone's bottom border further down.
4. Press the joystick again to reduce the zone's size. The zone's borders will appear red.
  - a. Moving the joystick to the right will move the zone's left border further to the right.
  - b. Moving the joystick to the left will move the zone's right border further to the left.
  - c. Moving the joystick up will move the zone's bottom border further up.
  - e. Moving the joystick down will move the zone's top border further down.
5. To exit edit mode, press & hold the camera's joystick controller for three (3) seconds.

### EXIT\_JUMP

Go to the Exit menu to save & exit, or exit without saving

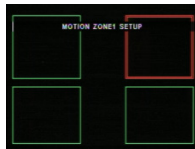
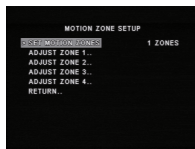



## PRIVACY (PRI)

### PRIVACY MASK

You can hide some parts of the screen for privacy purposes. A total of 6 privacy masks are available.

To enable Privacy Zone Masking, Select ON.

1. Select a mask (1-6) and enable by selecting ON.
2. Enter edit mode for a desired mask. The edit mode will display all masks that have been turned ON. The mask you selected will appear in WHITE. All other enabled masks will appear in GREEN.
3. When the mask in WHITE, use the joystick to move the mask to the area you wish to hide.
4. Press the joystick. The mask's color will change to BLUE. Use this option to adjust the mask's size.
5. Move the joystick Left and Right to adjust the width of the mask.
6. Move the joystick Up and Down to adjust the height of the mask.  
NOTE: when adjusting the size of the mask, the top and left borders of the mask will remain stationary. Only the right and bottom borders of the mask will move to adjust the mask's size.
7. If you have enabled multiple masks, press the joystick again to remain in edit mode and move to the next mask chronologically. If you are in size edit mode (BLUE mask) and you press the joystick once, the next mask will turn WHITE, and the previous mask would turn GREEN.
8. To exit edit mode, press & hold the joystick for three (3) seconds.

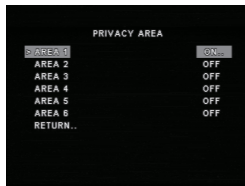
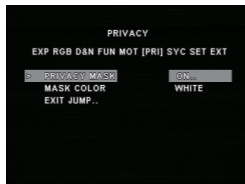

### MASK COLOR

Adjust the color of the privacy masks. Select from:  
WHITE / BLACK / RED

### EXIT\_JUMP

Go to the Exit menu to save & exit, or exit without saving



## SYNC (SYC)

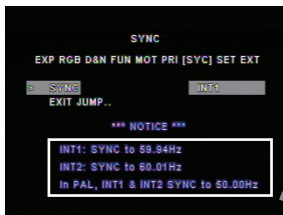

### INT1 INT2

Select INTERNAL if camera uses DC power, or if L/L is not required. Please note this setup option is only for NTSC version.

*\*\*Consult your installer for additional information and assistance with configuration.\*\**

INT1: SYNC to 59.94Hz  
INT2: SYNC to 60.01Hz  
In PAL, INT1 & INT2 SYNC to 50.00Hz.

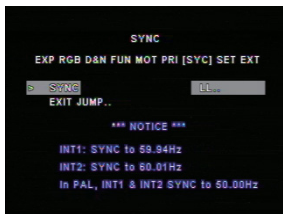

### LL (Line Lock)

Select L/L to synchronize video signals when two or more cameras are using AC power in a switching system.

### EXIT\_JUMP

SAVE & EXIT  
EXIT

Exit the OSD after saving the current settings.  
Exit the OSD without saving.





## SET-UP (SET)



### PC CONTROL

- CAMERA ID (1~255)

You can assign ID number for the camera (1 by Default).

- PROTOCOL (PELCO-D by Default)

- BAUD RATE (2400 / 4800 / 9600 / 19200)

Adjust data communication speed. Default is 9600.

### TITLE

Select if you want to display the camera's title on screen. You can setup a title up to 8 characters long. To edit the camera's title, move the joystick to the right. The 1st letter will be highlighted. Move the joystick left and right to select the desired character. Press the joystick to move to the next space and repeat as necessary.

ID POSITION- Select the position for the camera's Title:

- Up-Left
- Up-Center
- Up-Right
- Down-Left
- Down-Center
- Down-Right

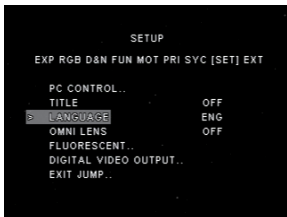

### LANGUAGE

You can select language you want to display on the monitor.

ENGLISH / DEUTSCH / FRANCAIS / ITALIAN / ESPANOL / DUTCH



## SET-UP (SET)



### OMNI LENS\*\*

You can set OMNI LENS menus when you use Omni Focus Lens.

When OMNI LENS is set ON , you can set the following sub-menus.

- **ALARM** works with MOTION DETECT function. When motion is detected, camera gives an alarm. Select ON or OFF.
- **READ TIME** is to set how many seconds to stay in zoom in. Select from **5** to **15** seconds.
- **ALARM ZOOM** is to set zoom rate when alarm occurs. Select from **4** to **214**.
- **STAND BY** is the zoom rate when it's normal scene. Therefore, when alarm disappear the zoom rate comes back to STAND BY rate. Select from **0** to **214**.

### FLUORESCENT

CRR (Color Rolling Reduction)

\*\*Only for NTSC version\*\*

- CRR1 If you use a manual lens, select CRR1 to release Rolling/Flicker problem.
- CRR2 If you use a DC lens, select CRR1 to release Rolling/Flicker problem.

### DIGITAL VIDEO OUTPUT

- DIGITAL OUTPUT (OFF / ON)
- FIELD ORDER (NORMAL / REVERS)
- FRAME RPT (OFF/ 2X / FREEZE)

### EXIT\_JUMP

SAVE & EXIT

EXIT

Exit the OSD after saving the current settings.  
Exit the OSD without saving.

\*\*Omni-Lens Settings available only in cameras with Moni Lens.\*\*



## **EXIT (EXT)**

### **EXIT**

Exit the OSD without saving.

### **SAVE & EXIT**

Exit the OSD after saving the current settings.

### **FACTORY SET**

Go back to factory default.

## **TROUBLESHOOTING**

---

Before sending your camera for repair, check the following or contact our technical specialist.

### **FOR NO VIDEO**

Check the coaxial cable and make sure it is connected securely.

Check the lens' iris adjustment at the camera's OSD menu.

Check the power supply and make sure the camera has the proper voltage and current.

### **FOR OUT-OF-FOCUS VIDEO**

Check the clear dome cover and the lens for dirt or fingerprints. Use a soft cloth and gently clean. Check the lens' manual focal and zoom adjustment. The use of a field test monitor is recommended.



## WARRANTY INFORMATION\*

Digital Watchdog (referred to as “the Warrantor”) warrants the Digital Watchdog Camera against defects in materials or workmanship as follows:

**LABOR:** For the initial five (5) years and one (1) year on IR LED from the original purchase date, if the camera is determined to be defective, the Warrantor will repair or replace the unit with a new or refurbished product at its option at no charge.

**PARTS:** In addition, the Warrantor will supply replacement parts for the initial five (5) years and one (1) year on IR LED.

To obtain warranty or out of warranty service, please contact a Technical Support Representative at **1-866-446-3595** Monday through Friday from 8:30AM to 8:00PM Eastern Standard Time.

A purchase receipt or other proof of the original purchase date is required before warranty service is rendered. This warranty only covers failures due to defects in materials and workmanship which arise during normal use. This warranty does not cover damage which occurs in shipment or failures which are caused by products not supplied by the Warrantor or failures which result from accident, misuse, abuse, neglect, mishandling, misapplication, alteration, modification, faulty installation, set-up adjustments, improper antenna, inadequate signal pickup, maladjustment of consumer controls, improper operation, power line surge, improper voltage supply, lightning damage, rental use of the product or service by anyone other than an authorized repair facility or damage that is attributable to acts of God.

## LIMITS & EXCLUSIONS\*

There are no express warranties except as listed. The warrantor will not be liable for incidental or consequential damages (including damage to recording media without limitation) resulting from the use of these products or arising out of any breach of the warranty. All express and implied warranties, including the warranties of merchantability and fitness for particular purpose, are limited to the applicable warranty period set forth above.

Some states do not allow the exclusion or limitation of incidental or consequential damages, or limitations on how long an implied warranty lasts, so the exclusions or limitations listed above may not apply to you. This warranty gives you specific legal rights, and you may also have other rights that vary from state-to-state.

If the problem is not handled to your satisfaction, then write to the following address:

Digital Watchdog, Inc.  
ATTN: RMA Department  
5436 W. Crenshaw Street  
Tampa, FL 33634

Service calls which do not involve defective materials or workmanship as determined by the Warrantor, in its sole discretion, are not covered. Costs of such service calls are the responsibility of the purchaser.

## SPECIFICATIONS\*

VIDEO	
Image Sensor	1/3" PIXIM Nightwolf CMOS Sensor
Total Pixels	768 (H) x 548 (V)
Scanning System	525 Lines, 2 : 1 Interlace
Frequency	15.734KHz (H), 59.95Hz (V)
Synchronization	Internal / Line Lock
Horizontal Resolution	690 Effective Horizontal TV Lines
Minimum Illumination	F1.2 (30IRE): 0.22Lux [Color]
	F1.2 (30IRE): 0.01 Lux [B&W]
S/N Ratio	50dB (AGC off)
Video Output	CVBS: 1.0Vp-p / 75 Ω
LENS	
Focal Length	3.3-12mm
Lens Type	DC Auto Iris
OPERATIONAL	
Lens	MANUAL / DC
AE Preference	OUTDOOR / INDOOR
Back Light Compensation	OFF/ ON
Wide Dynamic Range	LOW / NORMAL / MEDIUM / HIGH / CUSTOM
Auto Gain Control	LOW / MEDIUM / HIGH
Star-Light	OFF, x2-30FPS ~ x64

## SPECIFICATIONS\*

OPERATIONAL	
White Balance Mode	ATW/ PUSHLOK / MANUAL / AWC/ NORMAL
Day & Night	AUTO / COLOR / B&W
Mirror	OFF / MIRROR / V-FLIP / ROTATE
Sharpness	-8 ~ 8
3D Digital Noise Reduction	OFF/ LOW/ MEDIUM/ HIGH
Digital Zoom	x1 ~ x8
Privacy Zones	OFF / ON (6 Programmable Zones)
Baudrate	2400 ~ 38500
Protocol	PELCO-D
Language	ENGLISH, DEUTSCH, FRANCIAS, ITALIAN, ESPAÑOL, DUTCH
ENVIRONMENTAL	
Operating Temperature	-10°C ~ 55°C (14°F ~ 131°F)
Operating Humidity	Less than 90% (Non-Condensing)
Storage Temperature	-20°C ~ 70°C (-4°F ~ 158°F)
IP Rating	IP66 (Protects against dust and high pressure water.)
ELECTRICAL	
Power Requirement	Dual (12VDC & 24VAC)
Power Consumption	12VDC: 3.9W, 325mA 24VAC: 4.2W, 175mA
MECHANICAL	
Housing Material	Aluminum
Dimensions	230 X 86.5 mm (9.06 X 3.41 in)
Weight	1.50 lbs

\*Specification is subject to change without prior notice.



**MEMO\***

**MEMO\***

**MEMO\***





***Everything's Digital***

5436 W Crenshaw St. Tampa, FL 33634

Tel : 866-446-3595 / 813-888-9555

Fax : 813-888-9262

[www.Digital-Watchdog.com](http://www.Digital-Watchdog.com)

[technicalsupport@dwcc.tv](mailto:technicalsupport@dwcc.tv)

Technical Support Hours : Monday-Friday

8:30am to 8:00pm EST