

Indoor Dome Camera

DWC-D362D

DWC-D362DIR

User Manual



ABOUT MANUAL

Before installing and using the camera, please read this manual carefully.
Be sure to keep it handy for future reference.

PRECAUTIONS

- Do not open or modify.
- Do not open the case except during maintenance and installation, for it may be dangerous and can cause damages.
- Do not put objects into the unit.
- Keep metal objects and flammable substances from entering the camera. It can cause fire, short-circuits, or other damages.
- Be careful when handling the unit.
- To prevent damages, do not drop the camera or subject it to shock or vibration.
- Do not install near electric or magnetic fields.
- Protect from humidity and dust.
- Protect from high temperature.
- Be careful when installing near the ceiling of kitchen or a boiler room, as the temperature may rise to high levels.
- Cleaning :
To remove dirt from the case, moisten a soft cloth with a soft detergent solution and wipe.
- Mounting Surface :
The material of the mounting surface must be strong enough to support the camera.

FCC COMPLIANCE

This equipment has been tested and found to comply with the limits for a Class B digital device, pursuant to part 15 of the FCC rules. These limits are designed to Provide reasonable protection against harmful interference. when the equipment is operated in a residential environment. This equipment generates, uses, and radiates radio frequency energy; and if it is not installed and used in accordance with the instruction manual, it may cause harmful interference to radio communications.

WARNING : Changes or modifications are not expressly approved by the manufacturer.

Table of Contents

Introduction	Features	4-5
	Parts and Descriptions	6
	Dimensions	7
Installation	Included Accessories	8
	Easy Installations	9
	Base Installations	10
	Connecting to Monitors	11
	Adjusting the Camera	12
	Adjusting the 3-Axis Gimbal	13
Camera OSD Menu and Glossary		14-17
Troubleshooting		18
Warranty Information		19-20
Specifications		21

FEATURES*

DWC-D362D

- Sharp 1/3" CCD
- 540 TV Lines
- 2.8 ~ 11mm Varifocal Auto Iris Lens
- Electronic Day and Night
- DRC (Dynamic Range Compressor)
- HME (Highlight Masking Exposure)
- SLC (Side Light Compensation)
- AGC / BLC / AWB
- Mirror Image Control
- RS485 Built-In (Optional)
- Programmable Privacy Zone (4) & Motion Detection
- Easy Icon Driven OSD Menu with Built-In Joystick
- Auto Sensing 12VDC or 24VAC with Line Lock
- Secondary Video-BNC Output
- Video Test Output Included

FEATURES*

DWC-D362DIR

- Sharp 1/3" CCD
- 540 TV Lines
- 2.8 ~ 11mm Varifocal Auto Iris Lens
- 85ft Range IR with Intelligent Camera Sync
- Electronic Day and Night
- DRC (Dynamic Range Compressor)
- HME (Highlight Masking Exposure)
- SLC (Side Light Compensation)
- AGC / BLC / AWB
- Mirror Image Control
- RS485 Built-In (Optional)
- Programmable Privacy Zone (4) & Motion Detection
- Easy Icon Driven OSD Menu with Built-In Joystick
- Auto Sensing 12VDC or 24VAC with Line Lock
- Secondary Video-BNC Output
- Video Test Output Included

PART & DESCRIPTIONS*

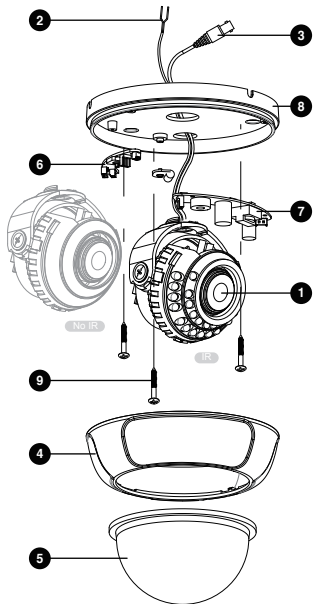

- 1 Lens
- 2 Power Input Connector
12VDC/24VAC Dual Voltage
- 3 Video Output Connector - BNC
- 4 Upper case
- 5 Bubble
- 6 Control board
- 7 Power board
- 8 Bottom case
- 9 Mounting screw

DIMENSIONS IN MILLIMETERS*

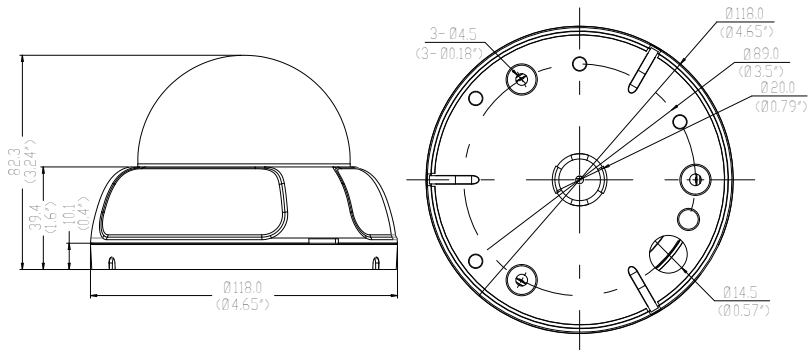

INSTALLATION*

Included with Value Line Indoor Dome Camera

1. User Manual
2. Mounting Template
3. Second Video Jack
4. Mounting Screw (3)

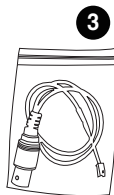
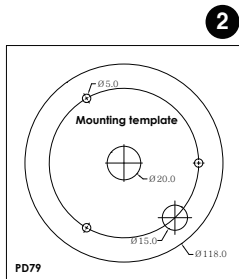

EASY INSTALLATION*

Install the Enclosure Cover

To install the dome cover, align the dome cover with the camera base and push until it securely snaps into place.

Dome Cover

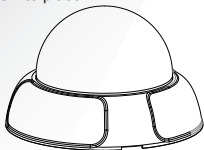

Camera Base

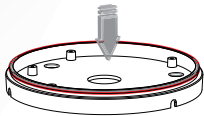

Remove the Dome Cover

Before you can mount or adjust your PD79, you must remove the dome cover. Insert a coin or screwdriver in the slot on the dome cover, then twist to pry the dome cover from the camera base.

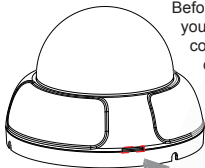

BASE INSTALLATION*



1. Pull wires through and make connections, Refer to page 11. Use mounting template to mount camera with dry wall mounts and wood screws.



2. Adjust the camera's pan, tilt and zoom. See page 13 for details.



3. Use the joystick to adjust the OSD menu. See page 14~17 for details.

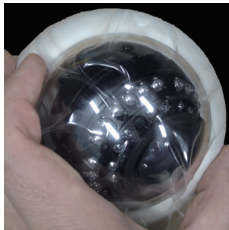

4. Attach the camera housing to the junction box using the assembly screws.

CONNECTING TO MONITORS*

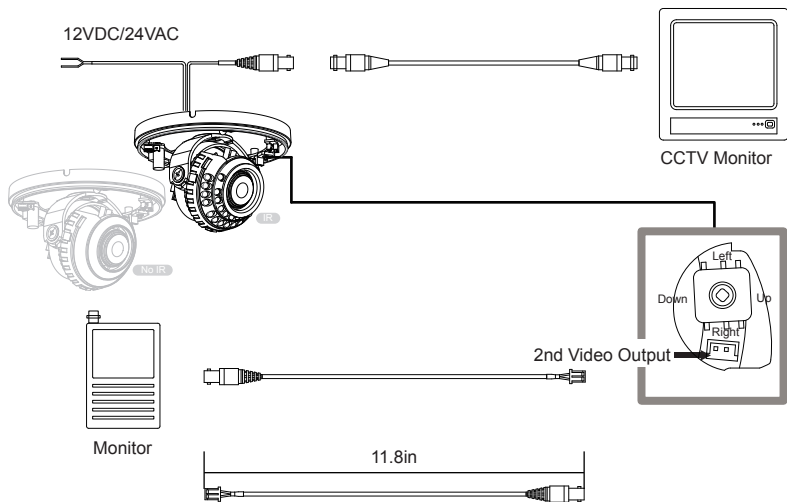

- Power connection - 12VDC/24VAC Dual Voltage.(Auto polarity detection and protection)
- All camera are equipped with a 2nd video output on the camera Main Board.

ADJUSTING THE CAMERA*

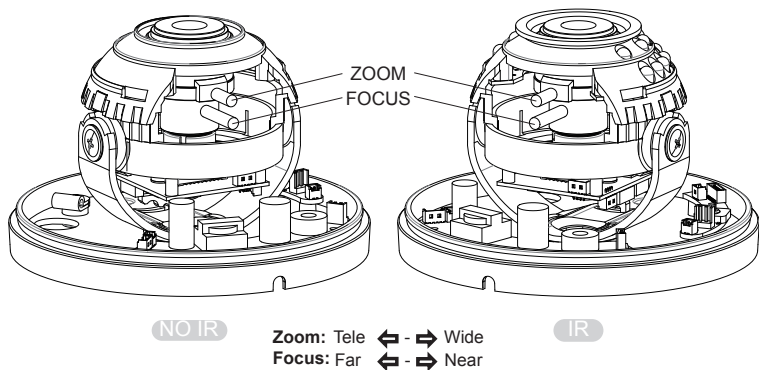

- 1 Loosen the Zoom & Focus Handles by rotating them counter-clockwise.
- 2 Adjust the Field of view by moving the handle to the RIGHT(Tele) to zoom in, or to the LEFT(Wide) to zoom out.
- 3 Adjust the Focus the same way as described above AFTER the desired Zoom position is established.
- 4 Once the desired adjustments have been made, please tighten the handles back by turning them clockwise.

ADJUSTING THE 3-AXIS GIMBAL*

The Gimbal mechanism yields maximum rotation and placement as shown below.

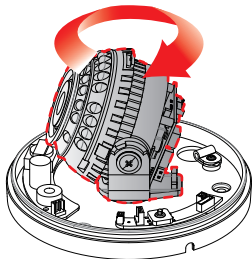

1 Rotation 360°

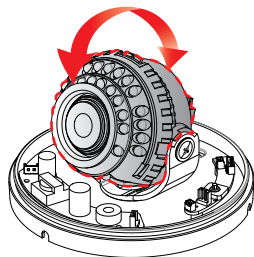



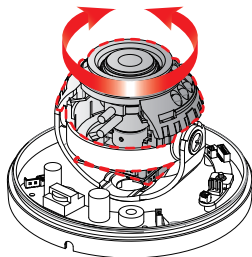





2 Tilting 70°



3 Panning 360°

MODULE OSD MENU*

EXPOSURE	COLOR	DAY&NIGHT
 <ul style="list-style-type: none"> └ LENS └ E.SHUTTER └ BLC └ AGC 	 <ul style="list-style-type: none"> └ WB MODE └ R-Y GAIN └ B-Y GAIN 	 <ul style="list-style-type: none"> └ D&N MODE
FUNCTION	MOTION	PRIVACY
 <ul style="list-style-type: none"> └ MIRROR └ SHARPNESS └ GAMMA └ SLC └ HME └ DRC 	 <ul style="list-style-type: none"> └ ALARM 	 <ul style="list-style-type: none"> └ MASK 1 └ MASK 2 └ MASK 3 └ MASK 4 └ COLOR SET
SETUP	EXIT	
 <ul style="list-style-type: none"> └ CAMERA ID └ TITLE EDIT └ TITLE RESET └ TITLE POSITION └ DPC SET └ LANGUAGE └ PC CONT. 	 <ul style="list-style-type: none"> └ EXIT └ SAVE & EXIT └ FACTORY SET 	

MODULE OSD MENU AND GLOSSARY*

EXPOSURE	
LENS	MANUAL (ELC LEVEL : 0 ~ 100) / DC (DC LEVEL : 0 ~ 31)
E.SHUTTER	1/60 / 1/100FLC / 1/250 ~ 100000 / AUTO
BLC	OFF / ON(Set Level 0~255) BLC (Back Light Compensation)
AGC	OFF ~ 36dB AGC (AUTO GAIN CONTROL)
COLOR	
WB MODE	AWC / ATW / MANUAL / PUSH LOCK
R-Y GAIN	0 ~ 255
B-Y GAIN	0 ~ 255
DAY & NIGHT	
Day & Night Mode	AUTO / COLOR / BW COLOR → BW : Switching from COLOR to BW; If the number is higher, the camera will only switch during a super low light condition. BW → COLOR : Switching from BW to COLOR; This number should be always lower than COLOR to BW Read Time : time interval to switch from COLOR to BW COLOR B&W : (BURST : OFF/ON) When the burst is OFF, the picture will have less noise.

FUNCTION

MIRROR	OFF / ON
SHARPNESS	0 ~ 49
GAMMA	USER / 0.45 / 0.6 / 1.00
SLC	OFF / ON (0 ~ 50) SLC (Side Light Compensation)
HME	OFF / ON (0 ~ 155) HME (Highlight Masking Exposure)
DRC	OFF / ON DRC (Dynamic Range Compressor)

MOTION

ALARM	OFF / ON
	SET WINDOW
	ALL SET (Set the Entire Screen)
	ALL CLEAR (Clear the Entire Screen)
	SENSITI. (0 ~ 55)
	SHOW INDI. (OFF / ICON / TRACE)
	DELAY OUT(1 ~ 15) Motion Alarm Zoom-In Delay

PRIVACY

MASK 1	OFF / ON ↕
MASK 2	OFF / ON ↕
MASK 3	OFF / ON ↕
MASK 4	OFF / ON ↕
COLOR SET	BLACK / GRAY / COLOR 1~ 6

SETUP

CAMERA ID	0 ~ 254
TITLE EDIT	
TITLE RESET	
TITLE POS.	
DPC SET	OFF / ON DPC (Dead Pixel Cancellation)
LANGUAGE	English / Chinese
PC CONT.	OFF / ON

EXIT

EXIT	Exit the menu
SAVE & EXIT	Exit the menu and save the setting
FACTORY SET	Reset the menu setting to factory default

TROUBLESHOOTING

Before sending your camera for repair, check the following or contact our technical specialist.

No VIDEO

Check the coaxial cable and make sure it is connected securely.

Check the lens' iris adjustment at the menu setup of the camera.

Check the power supply and make sure the camera has the proper voltage and current.

Out-of-Focus VIDEO

Check the clear dome cover and the lens for dirt or fingerprints. Use a soft cloth and gently clean.

Check the lens manual focal and zoom adjustment. Field test monitor is recommended.

WARRANTY INFORMATION*

Digital Watchdog (referred to as "the Warrantor") warrants the Digital Watchdog Camera against defects in materials or workmanship as follows:

LABOR : For the initial two (2) years and one (1) year on IR LED from the original purchase date, if the camera is determined to be defective, the Warrantor will repair or replace the unit with a new or refurbished product at its option at no charge.

PARTS : In addition, the Warrantor will supply replacement parts for the initial two (2) years and one (1) year on IR LED.

To obtain warranty or out of warranty service, please contact a Technical Support Representative at **1-866-446-3595** Monday through Friday from 8:30AM to 8:00PM Eastern Standard Time.

A purchase receipt or other proof of the original purchase date is required before warranty service is rendered. This warranty only covers failures due to defects in materials and workmanship which arise during normal use. This warranty does not cover damage which occurs in shipment or failures which are caused by products not supplied by the Warrantor or failures which result from accident, misuse, abuse, neglect, mishandling, misapplication, alteration, modification, faulty installation, set-up adjustments, improper antenna, inadequate signal pickup, maladjustment of consumer controls, improper operation, power line surge, improper voltage supply, lightning damage, rental use of the product or service by anyone other than an authorized repair facility or damage that is attributable to acts of God.

LIMITS AND EXCLUSIONS*

There are no express warranties except as listed above. The Warrantor will not be liable for incidental or consequential damages (including without limitation or damage to recording media), resulting from the use of these products or arising out of any breach of the warranty. All express and implied warranties, including the warranties of merchantability and fitness for particular purpose, are limited to the applicable warranty period set forth above.

Some states do not allow the exclusion or limitation of incidental or consequential damages, or limitations on how long an implied warranty lasts, so the exclusions or limitations listed above may not apply to you. This warranty gives you specific legal rights, and you may also have other rights that vary from state to state.

If the problem is not handled to your satisfaction, then write to the Address listed on the next page.

Service calls which do not involve defective materials or workmanship as determined by the Warrantor, in its sole discretion, are not covered. Costs of such service calls are the responsibility of the purchaser.

SPECIFICATION*

MODEL	DWC-D362D, DWC-D362DIR
General Spec	NTSC
CCD Type	1/3" 410K Pixels Color
Total number of pixels	811(H) x 508(V)
Min. Illumination	0.1Lux [(F1.2, 24IRE), (at COLOR)] 0.001Lux [(F1.2, 24IRE), (at B/W)]
Resolution	540 TV Lines [at COLOR] 580 TV Lines [at B/W]
Shutter speed	1/60s - 1/100,000s
S/N Ratio	50dB or more (AGC off)
Gamma	0.45
Sync System	Internal
Electric Spec	
Voltage	DC 12V (10V ~ 16V), AC 24V (20V ~ 28V)
Power Consumption	LED OFF : 1.8W,150mA(DC12V) / 1.8W,75mA(AC24V) LED ON : 5.0W,417.7mA(DC12V) / 4.6W,191.7mA(AC24V)
Mechanical Spec	
Operation temp	-10 °C ~ +50 °C (14°F ~ 122°F)
In storage temp	-20 °C ~ +70 °C (-4°F ~ 158°F)
Operation humidity	Under 90% (Non-condensing)



5436 W Crenshaw St. Tampa, FL 33634

Tel : 866-446-3595

Fax : 813-888-9262

www.Digital-Watchdog.com

technicalsupport@dwcc.tv

Technical Support Hours : Monday-Friday
8:30am to 8:00pm Eastern Time