



**DWC-MB721M4TIR**

**DWC-MB721M8TIR**

**IP 2.1MP Weather Resistant Bullet IR Camera**



ONVIF



Before installing or operating the camera, please read and follow this manual carefully.

## PRECAUTIONS

- Do not open or modify.
- Do not open the case except during maintenance and installation, for it may be dangerous and can cause damages.
- Do not put objects into the unit.
- Keep metal objects and flammable substances from entering the camera. It can cause fire, short-circuits, or other damages.
- Be careful when handling the unit.
- To prevent damages, do not drop the camera or subject it to shock or vibration.
- Do not install near electric or magnetic fields.
- Protect the camera from humidity and dust.
- Protect the camera from high temperature.
- Be careful when installing near the ceiling of a kitchen or a boiler room, as the temperature may rise to high levels.
- Cleaning: To remove dirt from the case, moisten a soft cloth with a soft detergent solution and wipe.
- Mounting Surface: The material of the mounting surface must be strong enough to support the camera.

## FCC COMPLIANCE

This equipment has been tested and found to comply with the limits for a Class B digital device, pursuant to Part 15 of the FCC rules. These limits are designed to provide reasonable protection against harmful interference, when the equipment is operated in a residential environment. This equipment generates, uses, and radiates radio frequency energy, and if it is not installed and used in accordance with the instruction manual, it may cause harmful interference to radio communications.

**WARNING:** Changes or modifications are not expressly approved by the manufacturer.

# TABLE OF CONTENTS\*

<b>Introduction.....</b>	<b>4</b>
Features.....	4
Parts .....	5
Dimensions.....	6
Inside the Box .....	7
<b>Installation.....</b>	<b>8</b>
Network Connection.....	8
Installation- Mounting .....	9
<b>MEGApix Camera Setup.....</b>	<b>10</b>
Installing the IP Finder.....	10
Using IP Finder Software.....	11-12
Network Options.....	13
Upgrading Cameras using the IP Finder Software.....	14
Camera Reboot.....	15
<b>MEGApix Camera Web Viewer.....</b>	<b>16</b>
Accessing the Web Viewer via Internet Explorer.....	16
Accessing the Web Viewer via Google Chrome, Mozilla Firefox and Safari.....	17
GUI Description .....	18
First & Second Stream.....	19
Export Image.....	20
Print Image.....	21
Instant Recording.....	22-23
<b>MEGApix Camera Setup.....</b>	<b>24</b>
Video .....	24-29
Event .....	30-32
Network.....	33-38
Record .....	39-42
System.....	43-48
<b>Specifications .....</b>	<b>49-50</b>
<b>Troubleshooting .....</b>	<b>51-54</b>
<b>Warranty.....</b>	<b>55</b>
<b>Limits &amp; Exclusions.....</b>	<b>56</b>

## FEATURES\*

- › ONVIF Compliant, Profile S
- › 2.1 Megapixels (1080P, 30fps)
- › Triple Codecs with Simultaneous Dual-Stream
- › 1/2.8" CMOS Sensor
- › 4.0mm Fixed Lens [DWC-MB721M4TIR]
- › 8.0mm Fixed Lens [DWC-MB721M8TIR]
- › 12X Digital Zoom
- › 50ft IR with Intelligent Camera Sync
- › TDN [True Day and Night]
- › Power over Ethernet [PoE] & DC12V
- › Micro SD/SDHC Class 10 Card for Emergency Backup [Not Included]
- › IP66 Certified [Weatherproof]
- › No Fog or Condensation under Any Weather Conditions
- › WDR [Wide Dynamic Range]
- › 3D-DNR [3D Digital Noise Reduction]
- › Motion Detection

## PARTS & DESCRIPTIONS \*

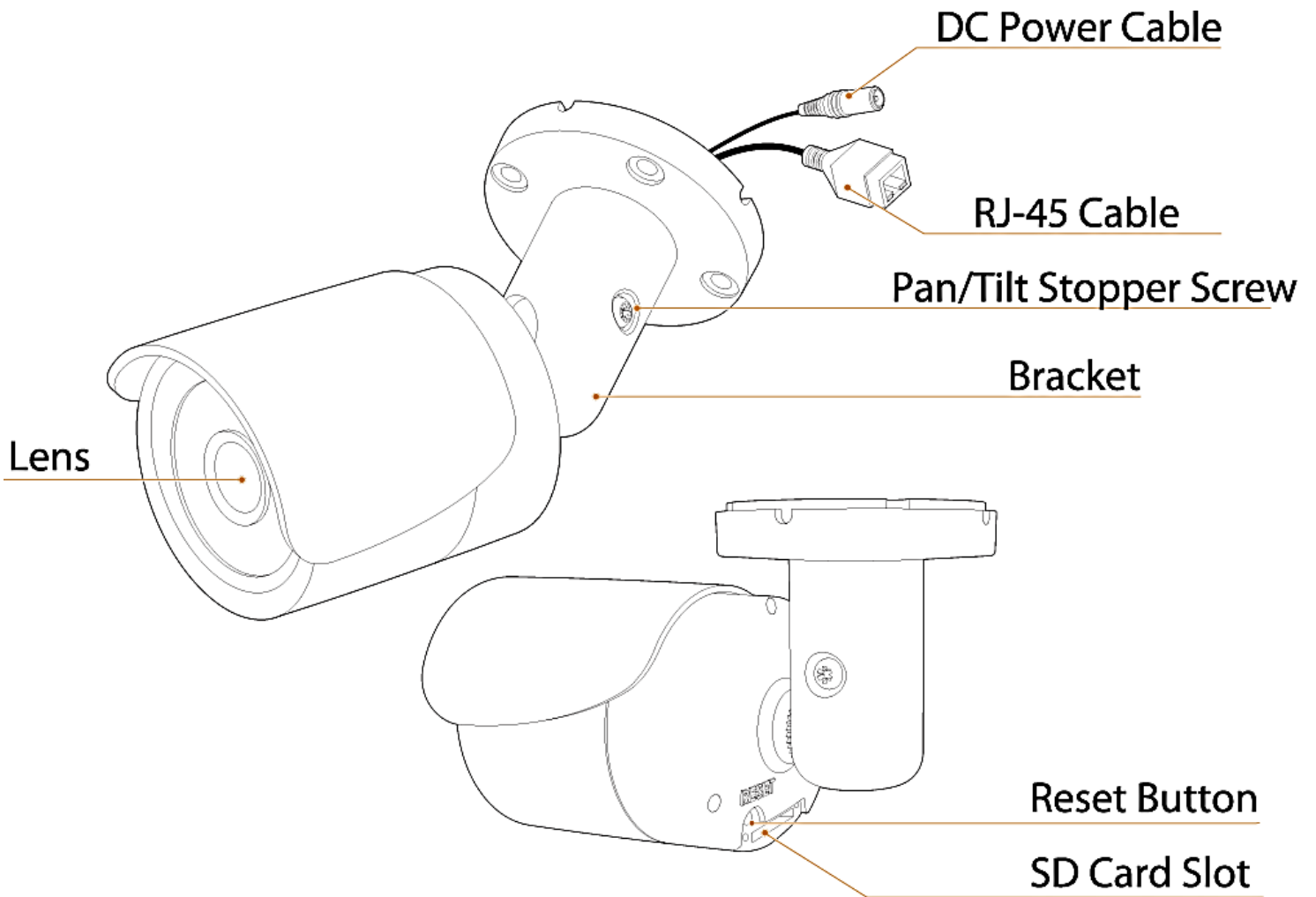

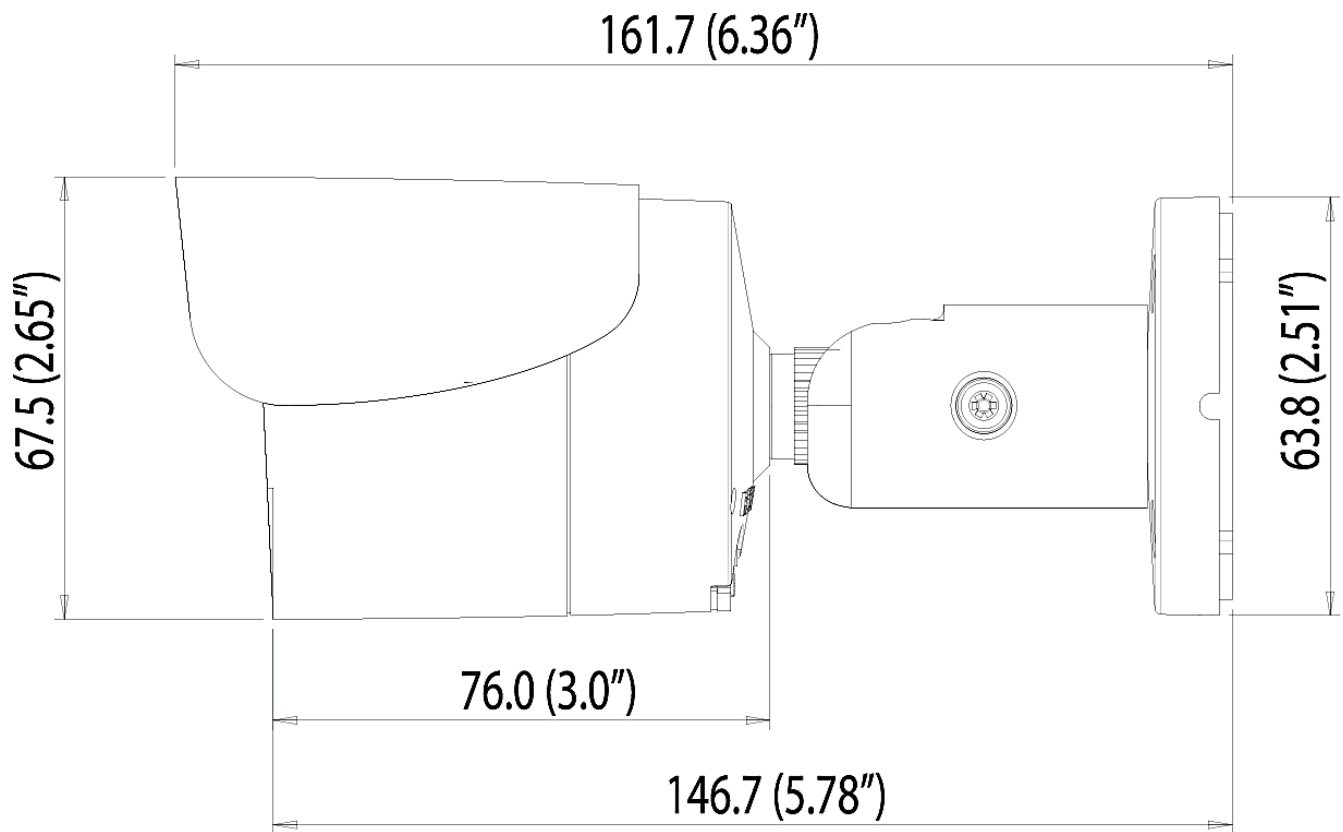
**DIMENSIONS\***

# INSIDE THE BOX \*

The following items are included with the MEGApix camera.

Quick Start  
Guide



L-Wrench



CD  
(Manual &  
Software)



Mounting  
Template

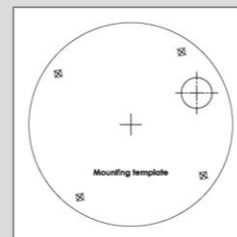

4 Screws & 4  
Dry Wall  
Anchors

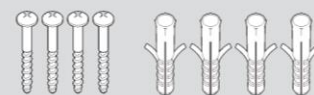

# NETWORK CONNECTION\*

## There are two options to power the MEGApix camera.

Use a PoE-enabled switch to connect data and power through a single cable and begin viewing and recording images instantly. A non-PoE switch will require an adaptor for power transmission.

### 1. Using a PoE-Enabled Switch

The MEGApix Camera is PoE-Compliant, allowing transmission of power and data via a single Ethernet cable. PoE eliminates the need for the different cables used to power, record, or control the camera. Follow the illustration below to connect the camera to a PoE-enabled switch using an Ethernet cable.

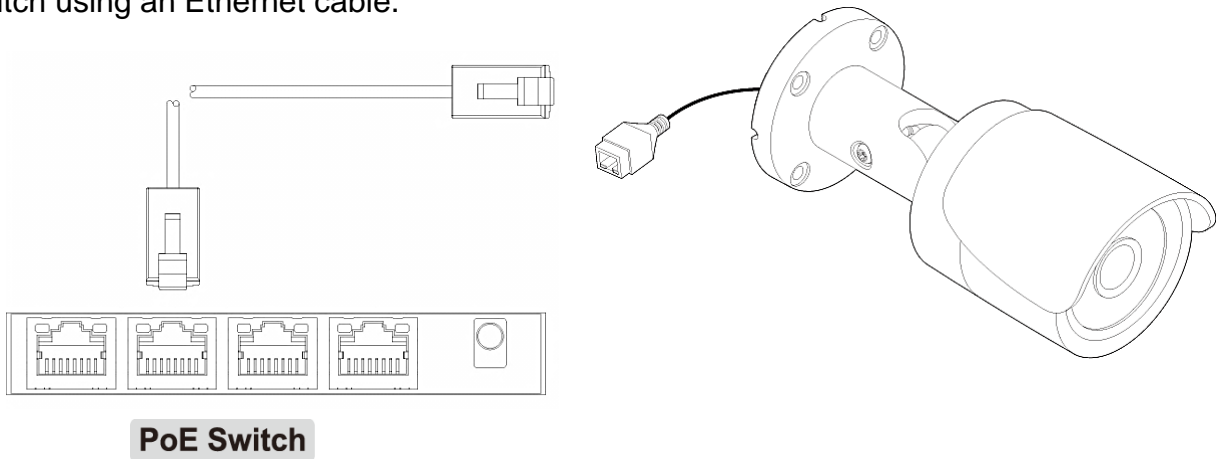

### 2. Using 12VDC

If a PoE injector is not available, use a power adaptor for power transmission and a non-PoE switch for data transmission. Follow the illustrations below to connect the camera without a PoE injector.

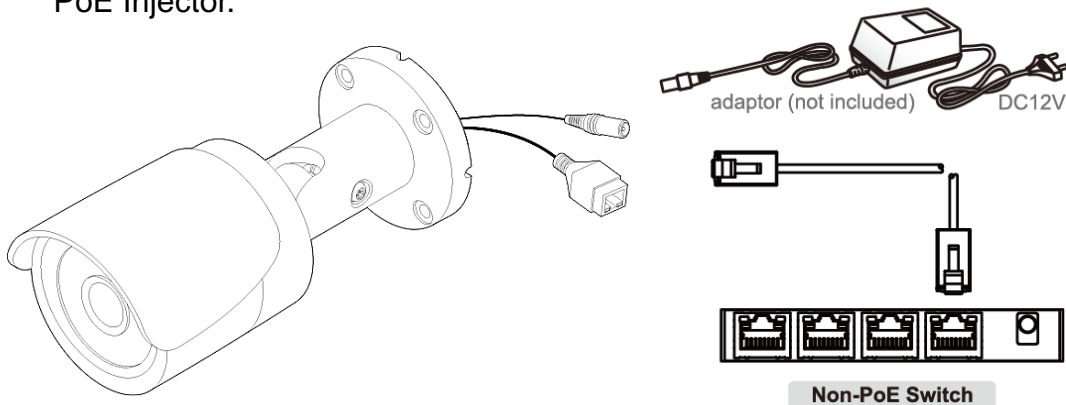



# INSTALLATION\*

## Preparing the Camera and Mounting Surface:

Before mounting the camera, please check the following:

1. The mounting surface must be able to sustain five times the weight of your camera.

## Mounting the Camera:

1. Use the camera's mounting template or the camera's housing to mark the drilling holes in the mounting surface.
2. Drill holes into the drywall using the included dry wall anchors.
3. Pull wires through and make connections.
4. Mount the camera to the wall or ceiling using the screws provided with the camera.
5. To adjust the camera's pan and tilt, loosen the Pan/ Tilt stopper screw by rotating it counter clock-wise.
6. Once the camera's an and tilt angles have been adjusted, tighten the Pan/ Tilt stopper screw back to secure the camera in its position by rotating it clock-wise.
7. When the installation is complete and before powering the camera, remove the protective cover sticker from the camera's vent hole. The vent hole is located on the back of the camera, above the reset button.

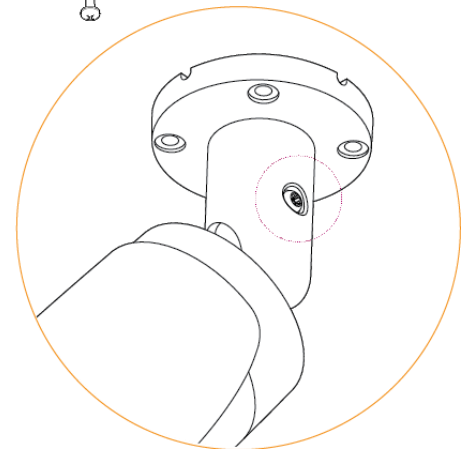
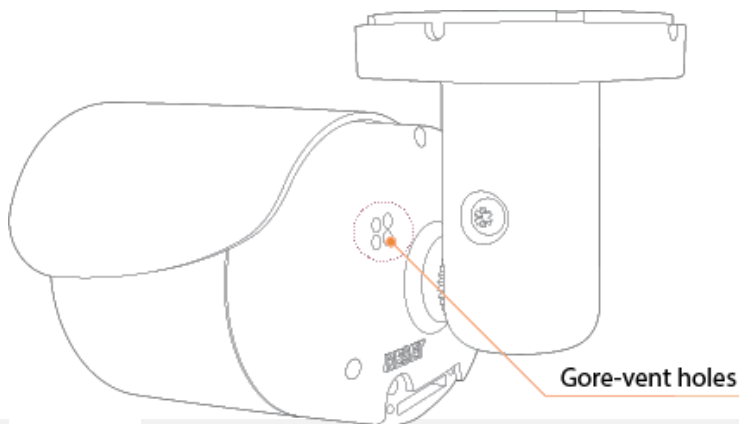
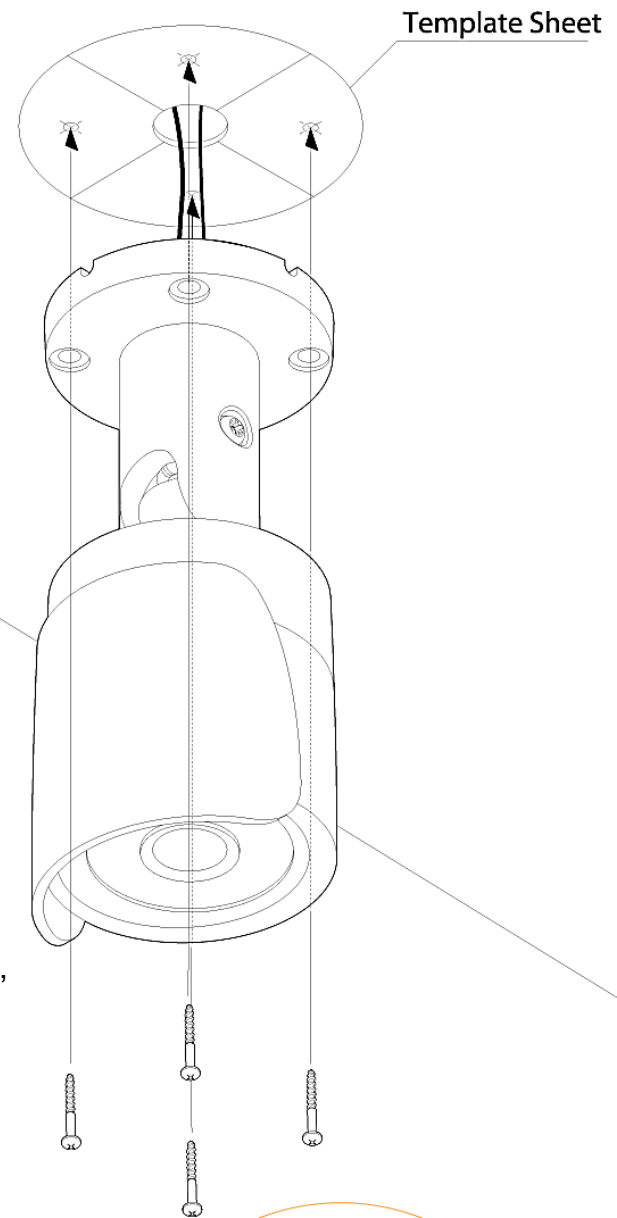

# IP FINDER SOFTWARE\*

## Installing IP Finder Software

IP Finder searches for all the available Digital Watchdog devices currently connected to your network.

1. Install **IP Finder** to find the MEGApix camera on your local network. The software can be found on the included User Manual CD. Run **IP Finder** and install onto your PC\*.
2. When setup is complete, launch **IP Finder**.
3. To find your MEGApix camera, click **Search** button. Your MEGApix camera will appear as **"DWC-MB721M4TIR."**
4. Select the desired device and click **Web Connect** to access the camera directly via Internet Explorer.

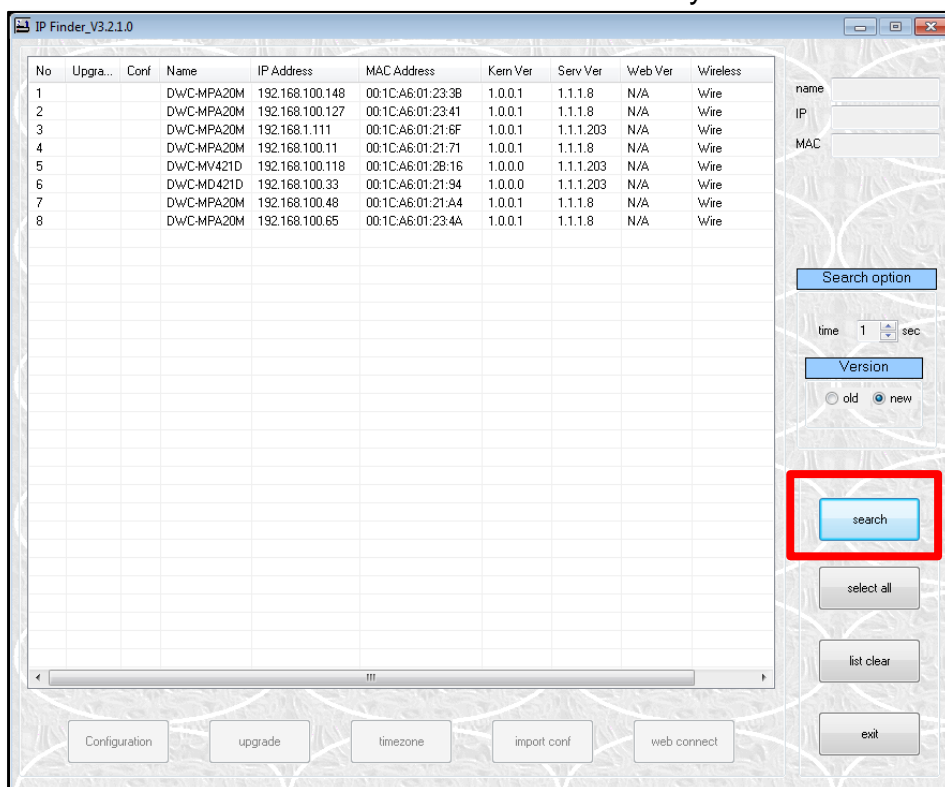

\*Install the IP Finder to a computer located on the same Subnet Mask as the MEGApix camera.

# IP FINDER SOFTWARE\*

## Using IP Finder Software

Use IP Finder to change the basic settings of your MEGApix camera or to connect to your MEGApix camera.

1. **Configuration:** Change the device's connection type and/or IP address information. See page 12 for more information.
2. **Upgrade:** Upgrade the camera's firmware. See page 14 for more information.
3. **Time-zone:** Change the time-zone on the camera.
4. **Import Config:** Import setup configuration.
5. **Web Connect:** Connect to the MEGApix camera through Internet Explorer.

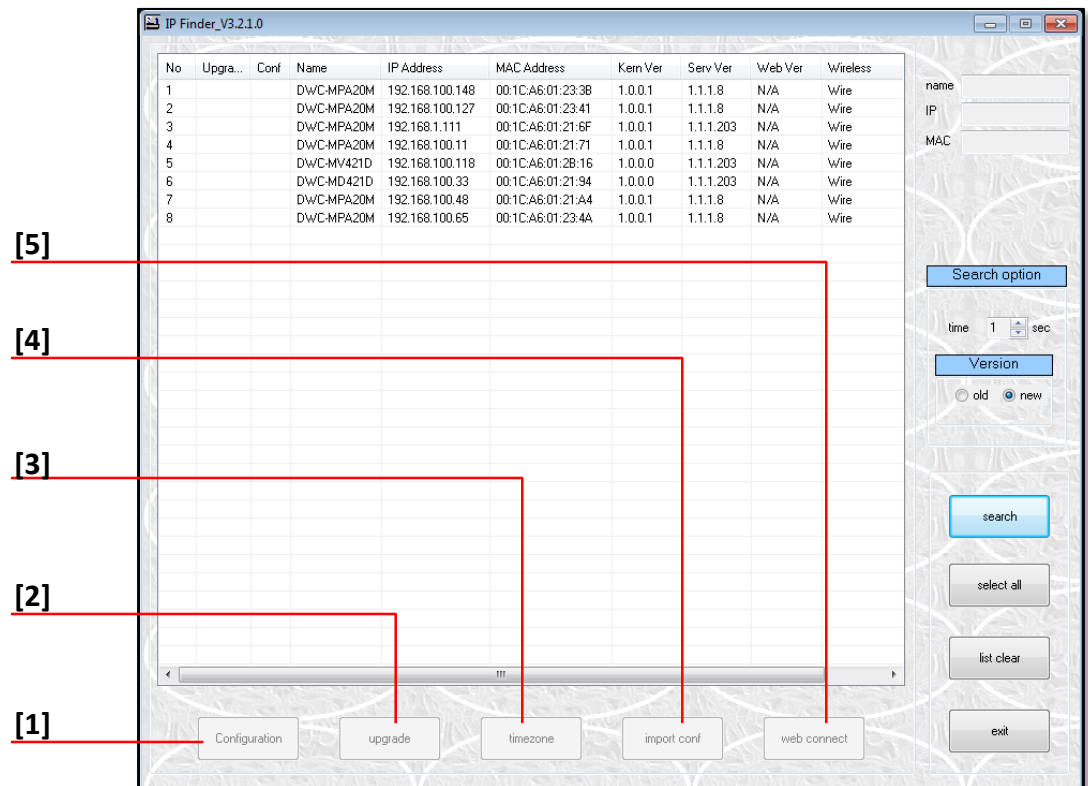

# IP FINDER SOFTWARE\*

## Using IP Finder Software

Use IP Finder to set the connection type and the IP address information for your MEGApix camera.

1. **DHCP:** Select DHCP to access the camera within the same internal network. For further explanation on DHCP, please see page 13.
2. **PPPoE:** requires previous registration. Enter the username and password.
3. **Static IP:** Select Static to connect to the camera from an external network. For further explanation on Static, please see page 13.
4. **Use DDNS:** Check this option to use DDNS service. For further explanation on DDNS, please see page 13.
5. **Port:** The port numbers required for communication with the camera. Use the IP Finder to change other basic settings for your MEGApix camera. (The menu options may vary depending on the camera model.)

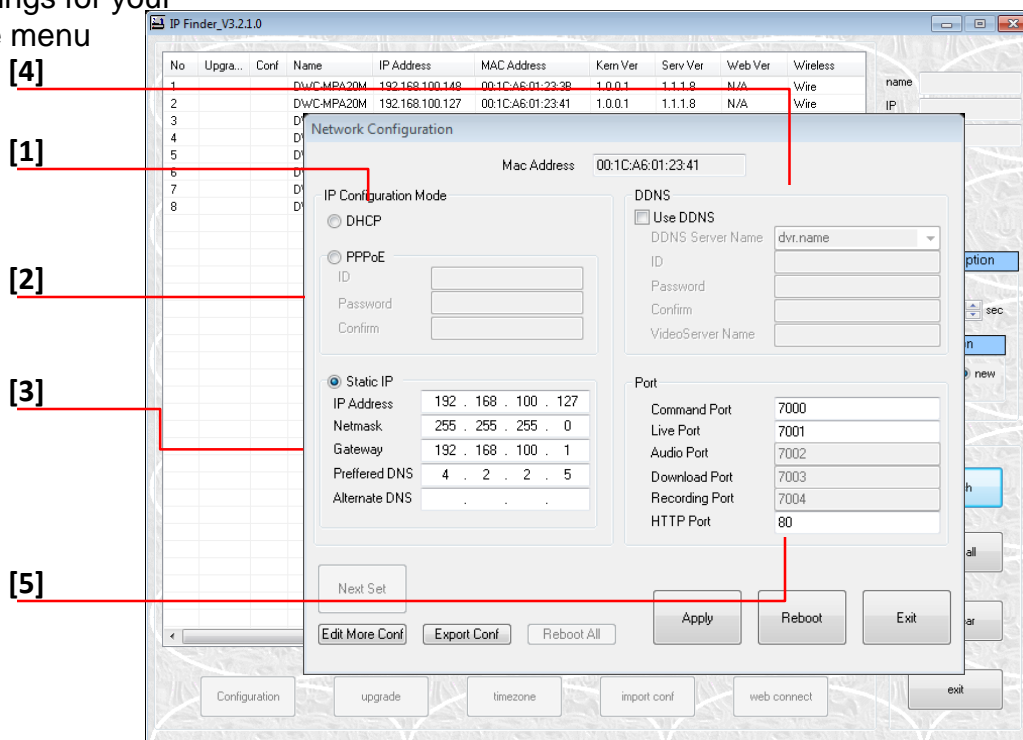

\*If you change the camera's IP, write down the camera's MAC Address for identification in the future.

# IP FINDER SOFTWARE\*

## DHCP

The Dynamic Host Configuration Protocol (DHCP) is a network configuration protocol that allows a device to configure automatically according to the network it is connected to.

If your network supports DHCP and your MEGApix camera is set to DHCP, IP Finder will automatically find and set your MEGApix camera to correspond with your network requirements.

## Static

Static IP addresses are recommended when using a network that does not support DHCP or when setting your device to be accessed externally via the internet. If Static is selected, you must manually enter the correct network settings for your MEGApix camera. The settings will correspond with your network. To set your camera to a static IP address, we recommend that you (1) setup the camera to DHCP, (2) allow it to configure itself according to your network, and (3) change the settings to a static IP address.

1. To set your MEGApix camera to Static, highlight the desired device from the search results list, and click on **Configuration**. In the “Network Configuration” window, make sure **Static** is selected.
2. Enter the following information: **IP Address**, **Net-mask**, **Gateway**, and **Preferred DNS**.
3. Click **Apply** and **Reboot** to save all changes.

## DDNS

Dynamic Domain Name Server is a feature that allows you to use a specific URL instead of an IP address to access your MEGApix camera. This feature is optional. It may require a subscription and fee.

1. To use the DDNS feature, check the box next to **Use DDNS**.
2. Select the server you wish to use. \*Some servers may require a subscription and fee.
3. If applicable, enter the **User ID** and **Password**.
4. Click **Apply** and **Reboot** to save all changes.

# IP FINDER SOFTWARE\*

## Upgrading Cameras using the IP Finder Software

Use IP Finder to perform firmware upgrade to all your MEGApix cameras from one convenient location.

1. Select all the cameras you would like to upgrade. You can select multiple cameras by clicking on multiple camera models while holding down the Ctrl button\*.
2. Press the 'Upgrade' button.
3. Browse and select the appropriate file to use for the upgrade. Press the 'OK' button.
4. The system will start updating all the selected cameras in a new window.
5. The system will indicate if the upgrade was successful or not for each camera.
6. When all cameras have been upgraded, press the 'Close' button
7. To complete the upgrade, reboot the cameras by pressing the 'server reboot' button.
8. Press 'Exit'
9. Allow up to 60 seconds for the cameras to reboot and press the 'Search' button. If the cameras reappear in the IP Finder the reboot is complete and the camera is ready.

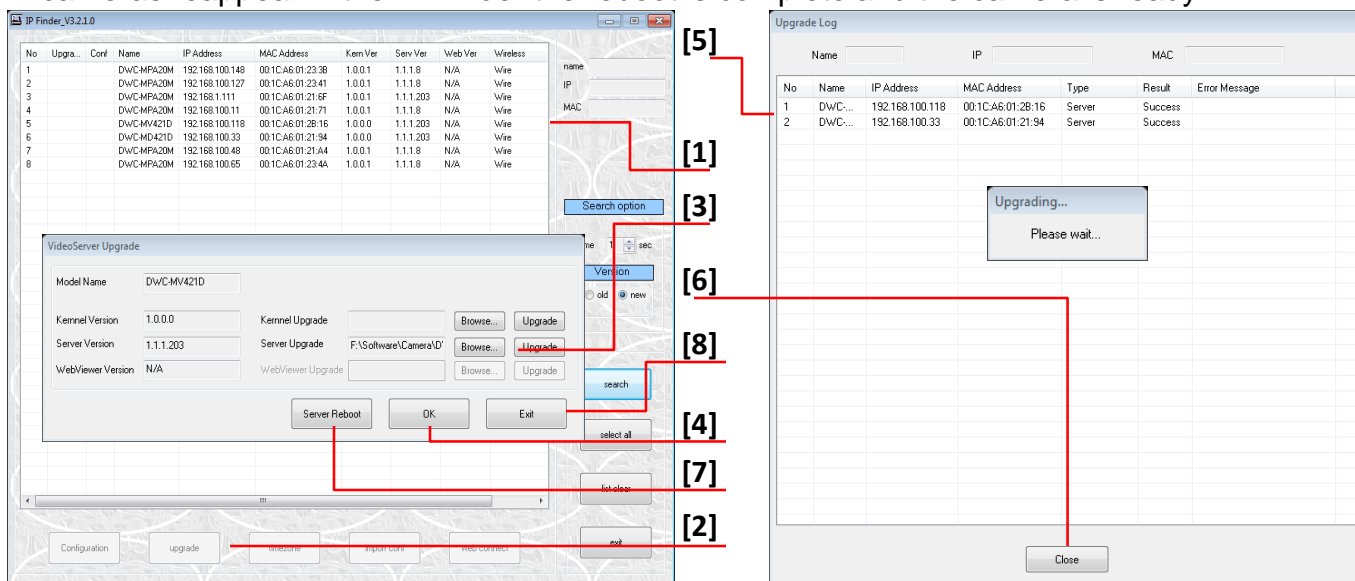

\* IP Finder can perform multiple upgrades at the same time only for the same camera models. Some cameras may require different firmware depending on the model.

# CAMERA REBOOT\*

## Resetting the Camera

Pressing the reset button on the camera's back for five (5) seconds will initialize all environmental variables to factory default. Previous setup for IP default, time, etc. will be deleted. If a system's IP address is lost, reset the camera back to factory default.

The following are the default network settings.

<b>IP Mode</b>	<b>DHCP</b>
<b>IP Address</b>	<b>192.168.1.123</b>
<b>Subnet Mask</b>	<b>255.255.255.0</b>
<b>Gateway</b>	<b>192.168.1.23</b>
<b>Command Port</b>	<b>7000</b>
<b>HTTP Port</b>	<b>80</b>
<b>Live Port</b>	<b>7001</b>

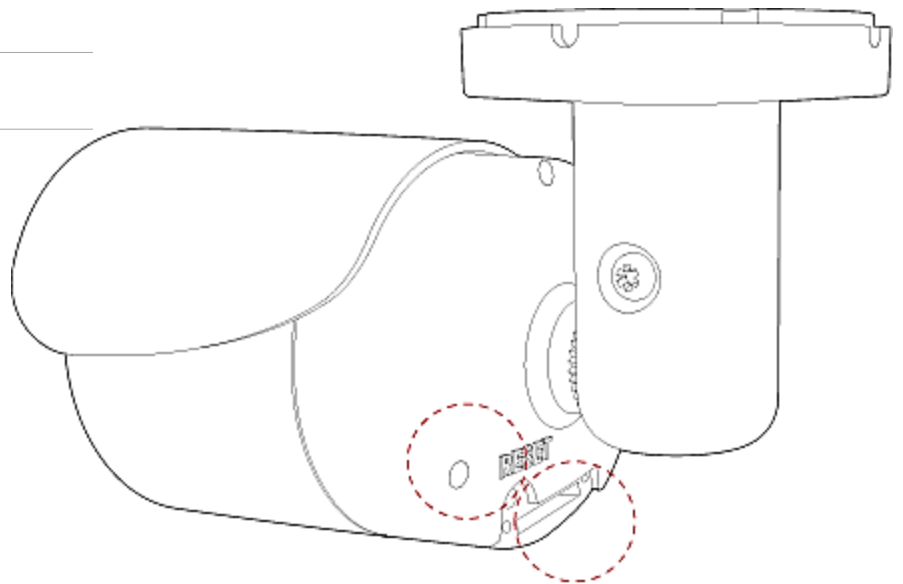

\* Frequent use may cause system error.

# WEBVIEWER\*

## Remote Video Monitoring Via Internet Explorer

Monitor and configure the MEGApix camera through a built-in web viewer.

1. Type the IP address of the camera in an Internet Explorer window.  
Example: `http://192.168.1.123` (Factory Default)
2. Enter **Username** and **Password**  
Default: Username: admin | Password: admin
3. The web browser will ask to install **ActiveX Control** to view video from the camera. Once it has been installed, Internet Explorer will display video images from the camera.

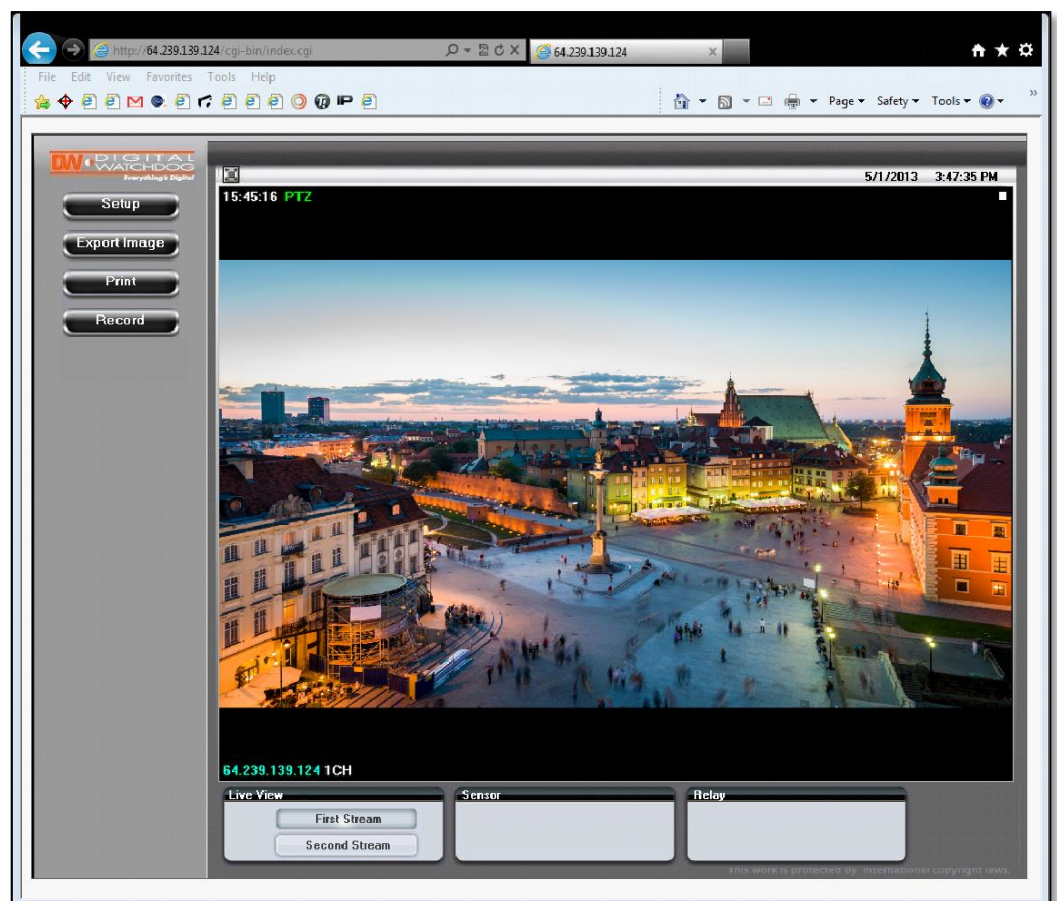



# WEBVIEWER\*

## Remote Video Monitoring Via Chrome, Firefox, or Safari

You can view your MEGApix camera using web browsers other than Internet Explorer. To do so, at least one of the streams of the camera must be set to the codec MJPEG.

1. Open Google Chrome, Mozilla Firefox, or Apple Safari Web Browser.
2. Enter the camera's IP address. If the first stream is set to H.264, video will not be displayed on the GUI.
3. Click the **Setup** button located at the top right side of the page. Then go to **Video > Stream Settings**.
4. Modify one of the two streams to the codec **MJPEG**.
5. Click **Apply** and **Reload** to make sure all changes have been saved.
6. Click on **Live View** to return to the camera's main page.
7. At the bottom of the page, select the stream you set as MJPEG to start streaming video.

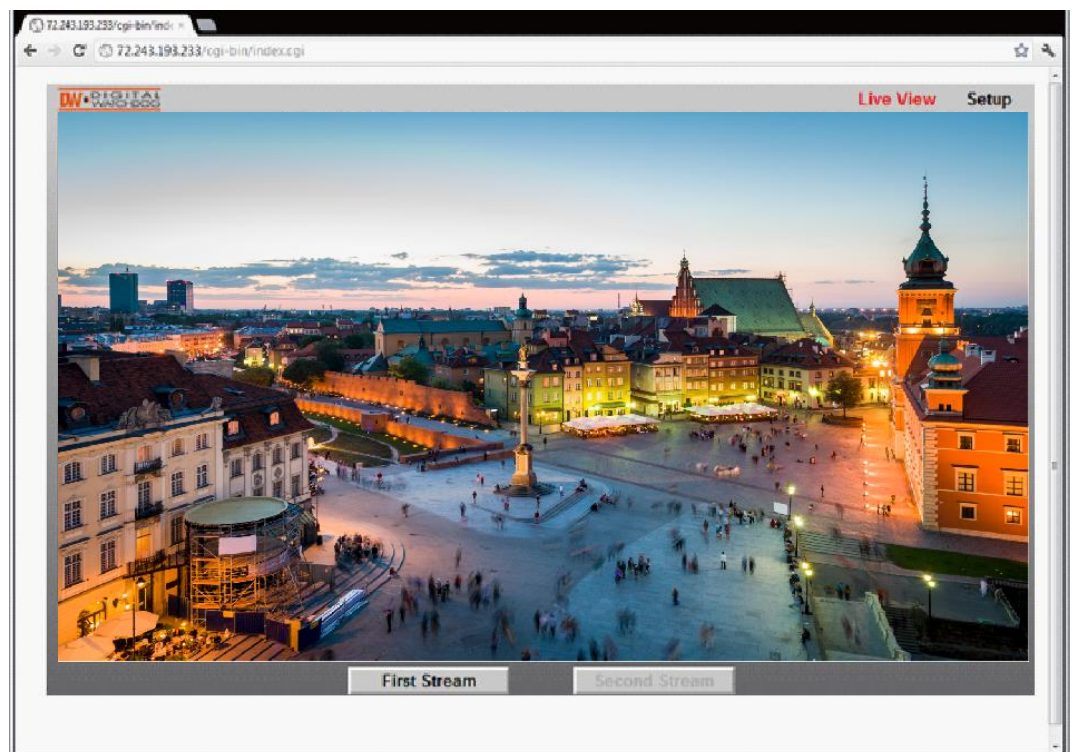

# WEBVIEWER\*

## GUI Description

- Camera's Name
- Full Screen Mode
- Camera's Time
- Access Setup Menu
- Export Camera's Current Display as JPEG
- Print Camera's Current Display
- Start/ Stop Panic Recording

- Main Display Area
- Alarm Status
- Computer Date & Time

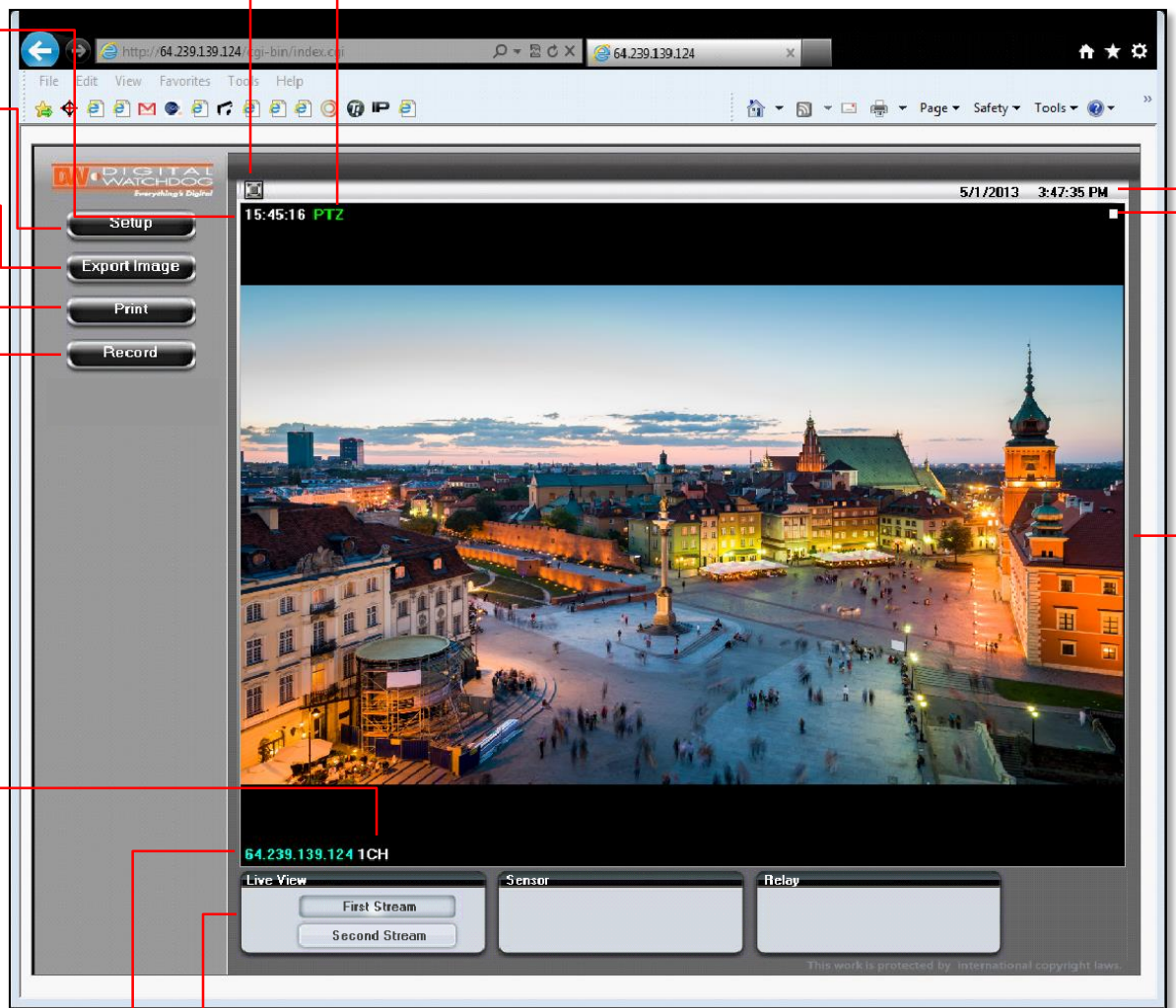

- Stream's Name
- Camera's IP Address
- Stream Control

# WEBVIEWER\*

## First Stream & Second Stream

Configure two stream settings for monitoring and recording.

On the main monitoring page, user can view the camera with the First Stream settings or the Second Stream settings. Below the display screen, click on the **First Stream** and **Second Stream** buttons to alternate between the different camera settings.

To Setup Stream Settings, refer to page 24.

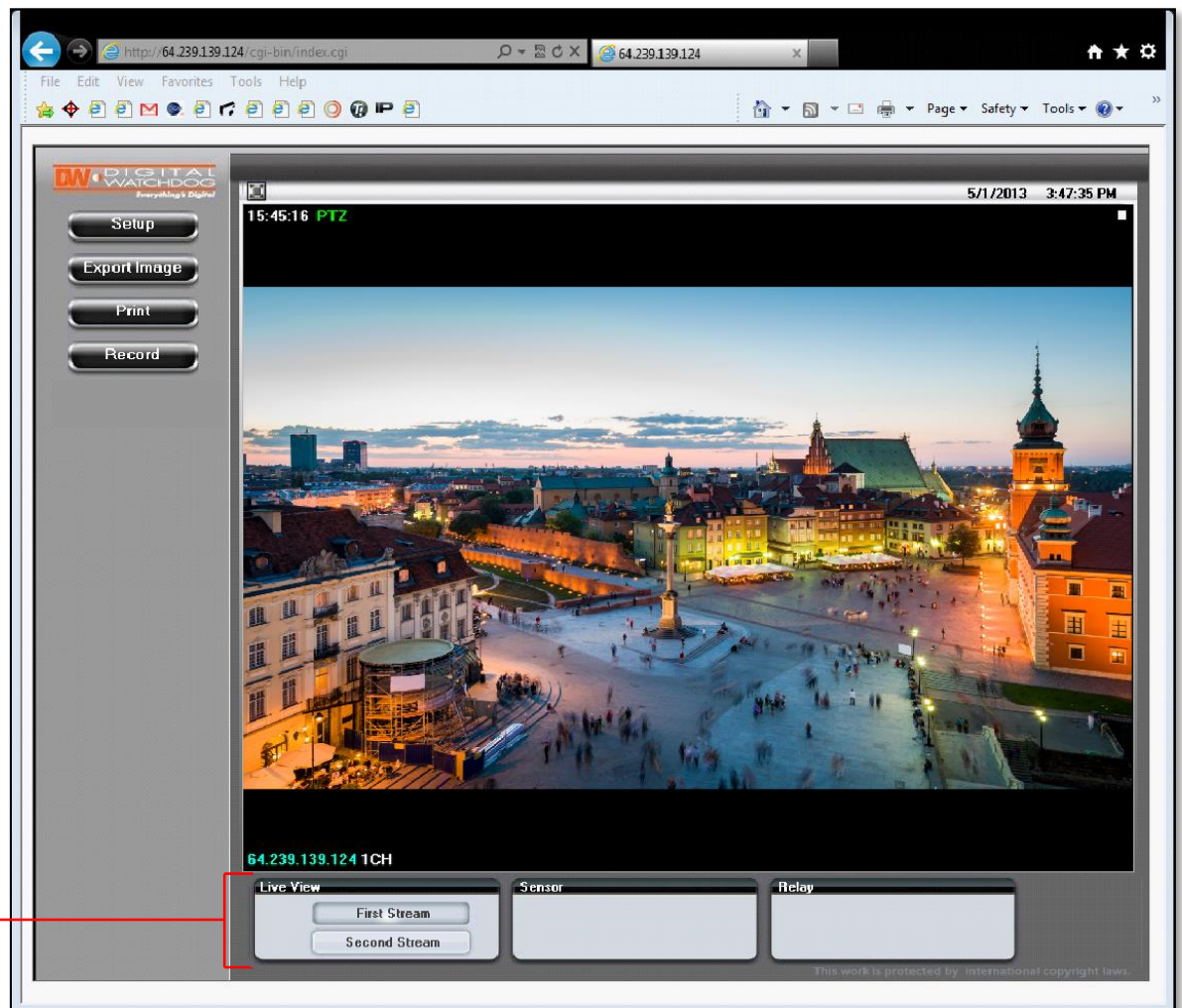

**[Streams Selection]**

# WEBVIEWER\*

## Export Image

Export a screenshot of the current live video to your computer.

1. Click **Export Image** button located on the left.
2. A .jpg image will automatically be stored under a WNMDWViewer folder.
3. The image's name will include the camera's IP address, Channel name, date, and time.

[Export Image]

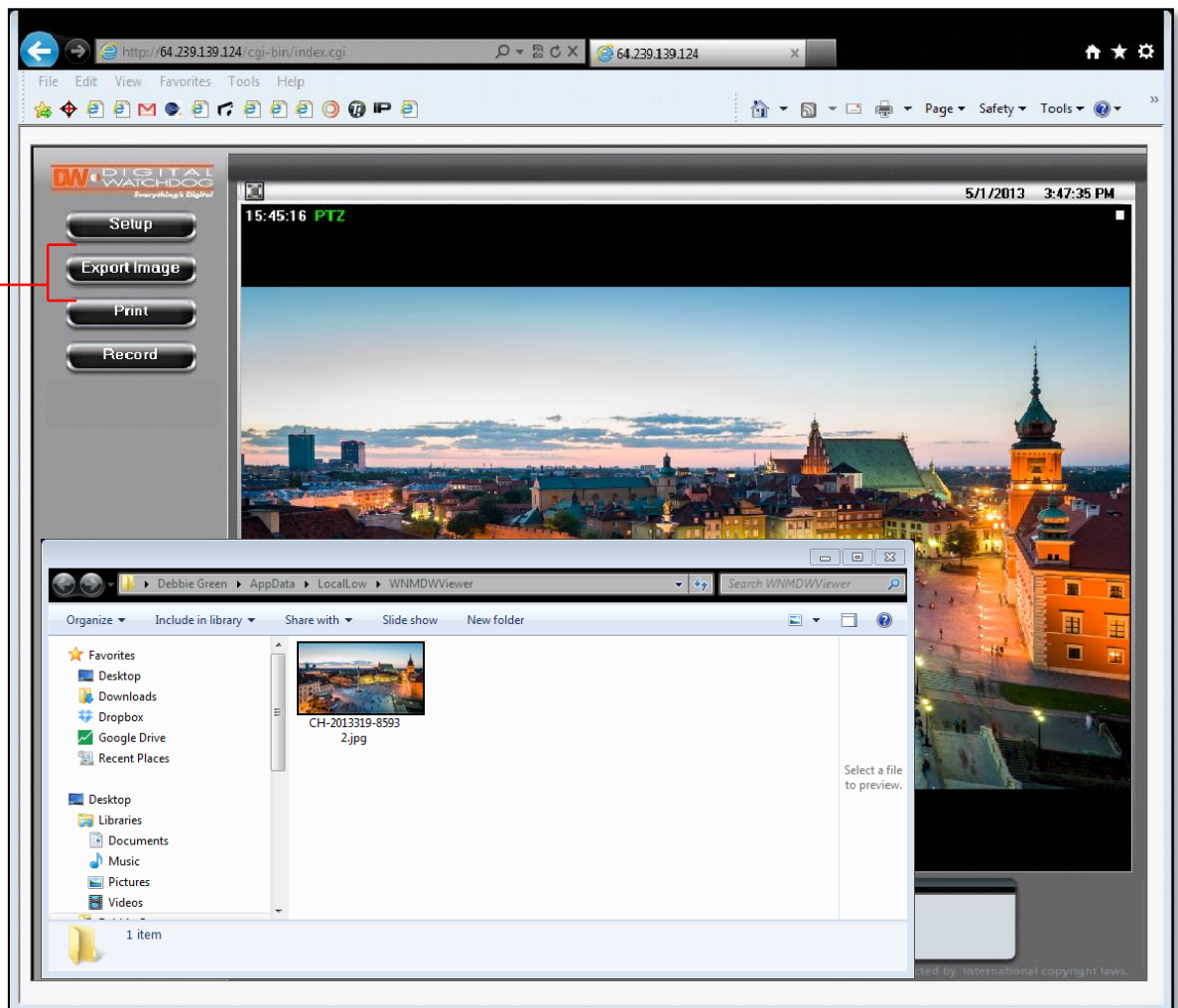



# WEBVIEWER\*

## Print Image

Print a screenshot of the current live video.

1. Click **Print** button, and the **Print Preview** window will appear.
2. Scale the size of the screenshot or adjust its orientation.
3. To print information about the screenshot, select **View Title**. To add a memo for the screenshot, click **Page Option**.
4. Go to **Printer Setup** to select the printer and manage the printer properties.
5. Select **Print** to print the page, or **Close** to cancel the print.

[Print Image]

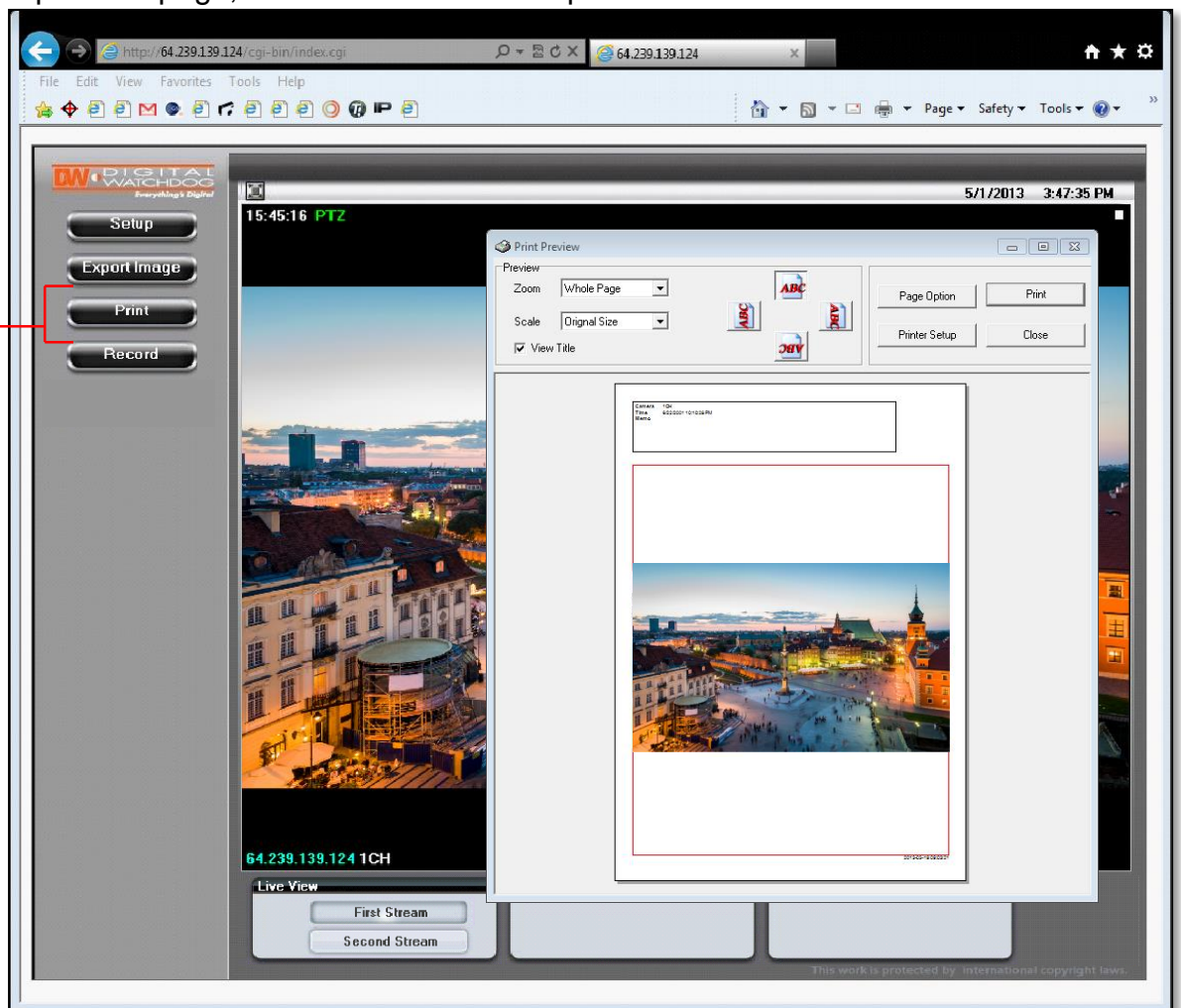

# WEBVIEWER\*

## Instant Recording

Record live video to your local drive.

*To Setup Instant Recording*

1. Click on the **Record** button located to the left of the Web viewer.
2. Setup where you want the videos to be saved.
3. Setup the duration of the instant recording. You can record up to 120 seconds of live video.
4. When setup is complete, click **OK** to save changes or **Cancel** to cancel any changes.

[Local Recording]

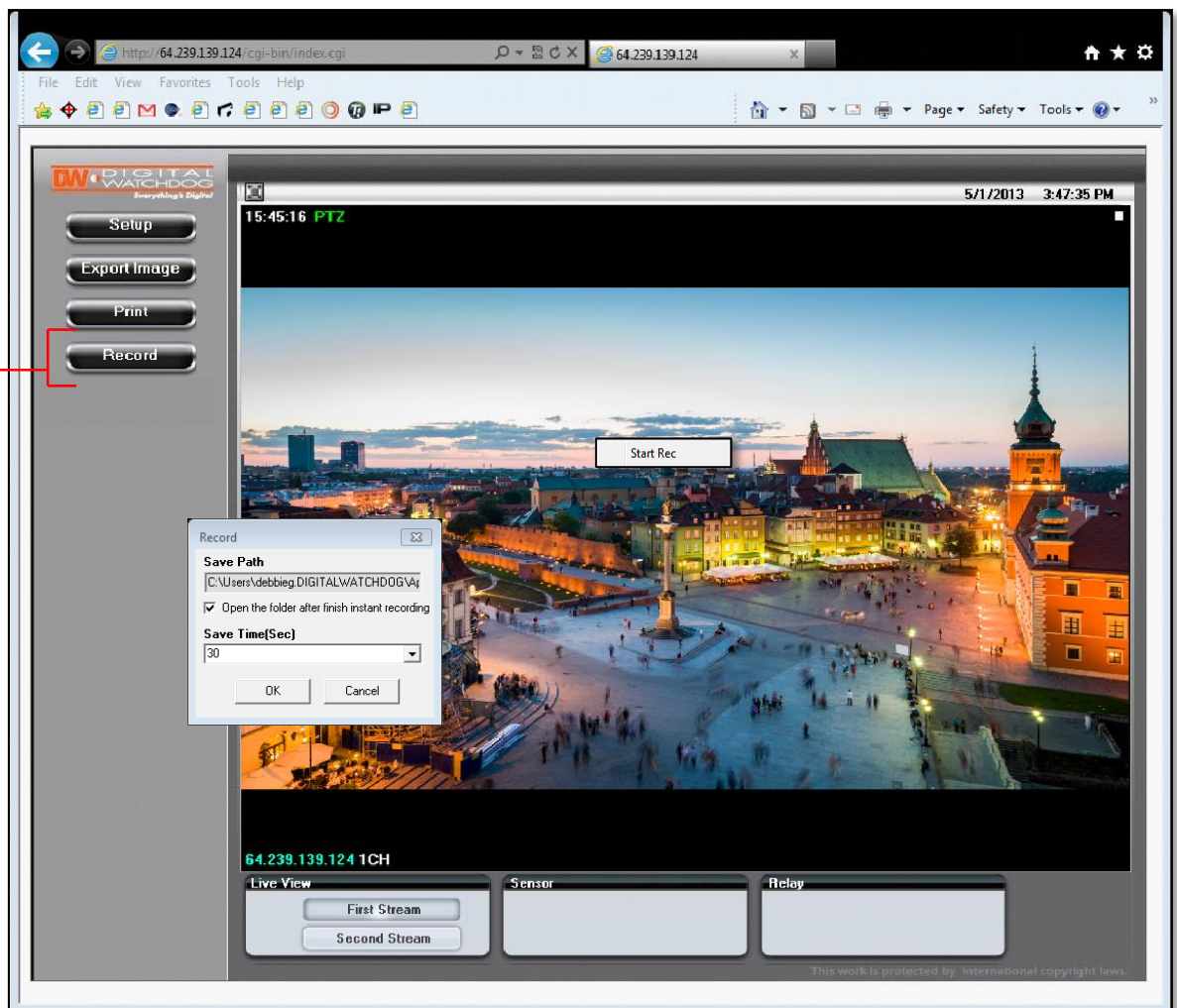

# WEBVIEWER\*

## Instant Recording

Record live video to your local drive.

*To Start and Stop Instant Recording*

1. To Start, right-click anywhere on the display screen.
2. Click on **Start Rec**. The icon on the top right of the screen will change to **INSTANT**.
3. To Stop, right-click anywhere on the display screen.
4. Click on **Stop Rec**. The video will be displayed in the designated folder when recording is complete.

[Local Recording]

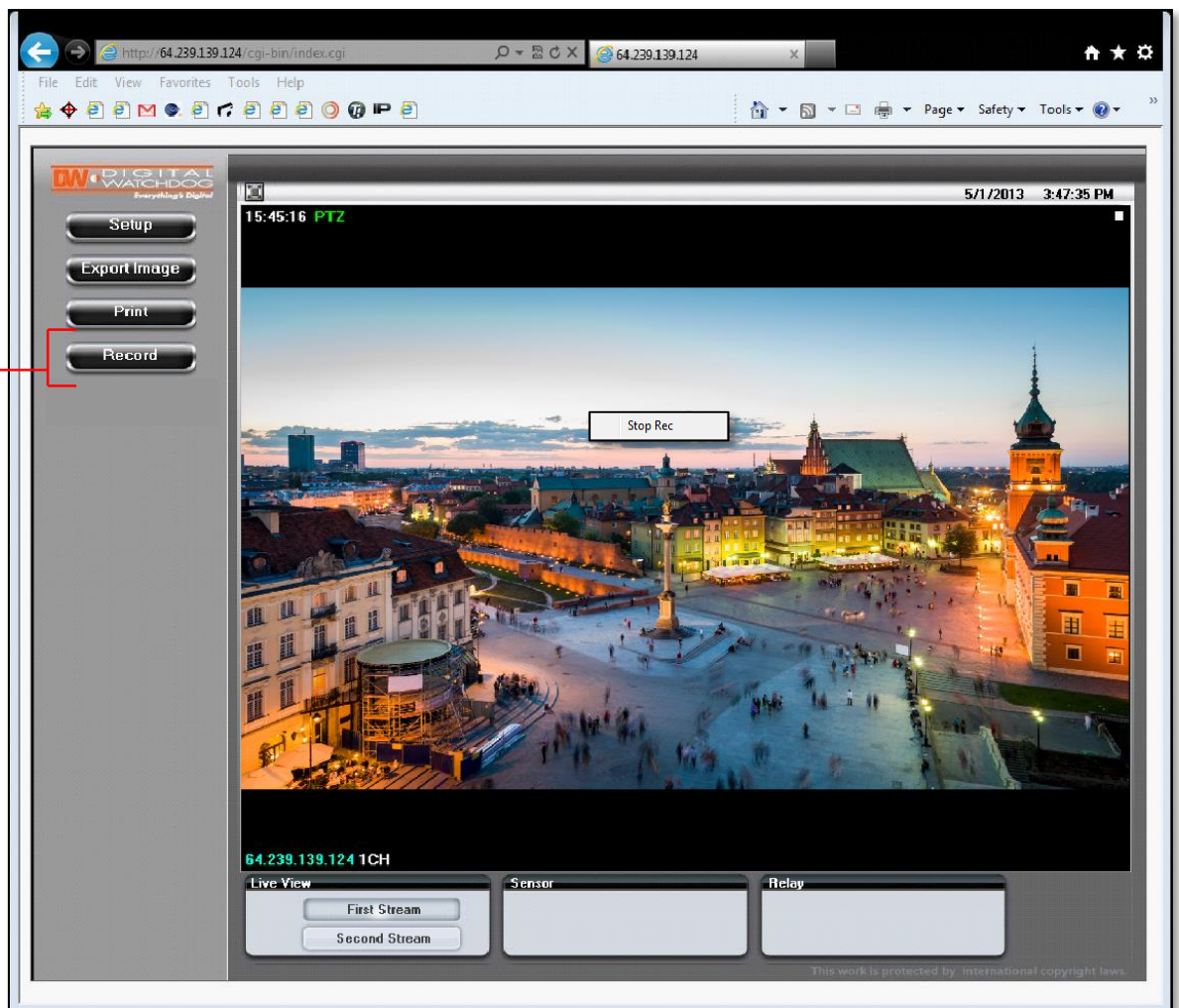

# WEBVIEWER\*

## Setup > Video > Stream Settings

The MEGApix camera allows you to setup two different streams to optimize storage and bandwidth usage.

1. Name- Set a unique name to each stream to identify them.
2. Resolution- Set Resolution for each stream. The better the resolution, the more bandwidth it will require to stream images.
3. Compression Type (Codec)- Select the type of compression to use when outputting the video. The compression type affects the image quality, bandwidth, and file size of saved images. MJPEG, the lowest Compression type, will provide the highest image quality, but also will cause the image size to be the largest, and take up the most bandwidth. H.264 Baseline Profile is the default codec.
4. Data Transfer Speed- Set encoding bitrate if H.264 and MPEG4 compression type is selected. Select from 1800 to 8000Kbps.
5. Frame-rate- Select from 0fps to 30fps. The camera is set by default to 28fps.
6. MJPEG Quality- Set MJPEG image quality. This is only available when the compression is set to MJPEG. The higher the quality, the more bandwidth will be required to stream the image.
7. Select '**Apply**' to save changes.

The screenshot shows the 'Stream Settings' configuration page. On the left is a navigation menu with categories: Video, Event, Network, Record, and System. The 'Video' category is expanded to show 'Stream Settings', 'Color Settings', and 'Privacy Zone'. On the right, the 'Stream Settings' form is displayed, divided into 'First Stream' and 'Second Stream' sections. At the bottom are 'Apply' and 'Reload' buttons. Red lines connect numbered callouts [1] through [7] to specific parts of the interface:

- [1] points to the 'Stream Settings' menu item in the navigation bar.
- [2] points to the 'Stream Settings' section header.
- [3] points to the 'Event' category in the navigation menu.
- [4] points to the 'Record' category in the navigation menu.
- [5] points to the 'System' category in the navigation menu.
- [6] points to the 'MJPEG Quality' dropdown menu in the 'First Stream' section.
- [7] points to the 'Apply' button at the bottom right.

Stream Settings	
<b>First Stream</b>	
Name :	1CH
Resolution :	1920x1080 (16:9)
Compression Type :	H.264 Baseline Profile
Data Transfer Speed :	5378 [1800 ... 8000] Kbps
Framerate :	28 (fps) [Avg. 5019Kbps]
MJPEG Quality :	Normal
<b>Second Stream</b>	
Name :	2CH
Resolution :	480x272 (16:9)
Compression Type :	H.264 Baseline Profile
Data Transfer Speed :	1024 [350 ... 8000] Kbps
Framerate :	7 (fps) [Avg. 238Kbps]
MJPEG Quality :	Low



# WEBVIEWER\*

## Setup > Video > Color Settings

Use the color settings menu to adjust the camera to its unique lighting environment and to get the best image quality.

**White Balance:** This gives the camera a reference to “true white.” White Balance is used to make colors appear the same in the Field of View (FoV) no matter what is the light temperature of the light source. Select: Auto, Indoor, Outdoor, Preset, Auto Ext, or Manual.

If AUTO, AUTO Ext, Indoor, or Outdoor are selected, the camera will automatically adjust itself.

If PRESET is selected, white balance is fixed based on current lighting. To activate, press the blue button that will appear next to the White Balance Settings.

If MANUAL is selected, adjust the following values:

- > Kelvin- Determines the warmth or coolness of the light. Select from Low, Middle, or High.
- > White Balance Red Offset- select from 0~20 range. The lower the number, the image will appear green. The higher the number, the image will appear red. Default value is 10.
- > White Balance Blue Offset- select from 0~20 range. The lower the number, the image will appear yellow. The higher the number, the image will appear blue. Default value is 10.

### [White Balance Settings]

Select: ‘Apply’ to save changes, ‘Reload’ to return to the last saved settings, or ‘Default’ to return all settings to their factory default values.

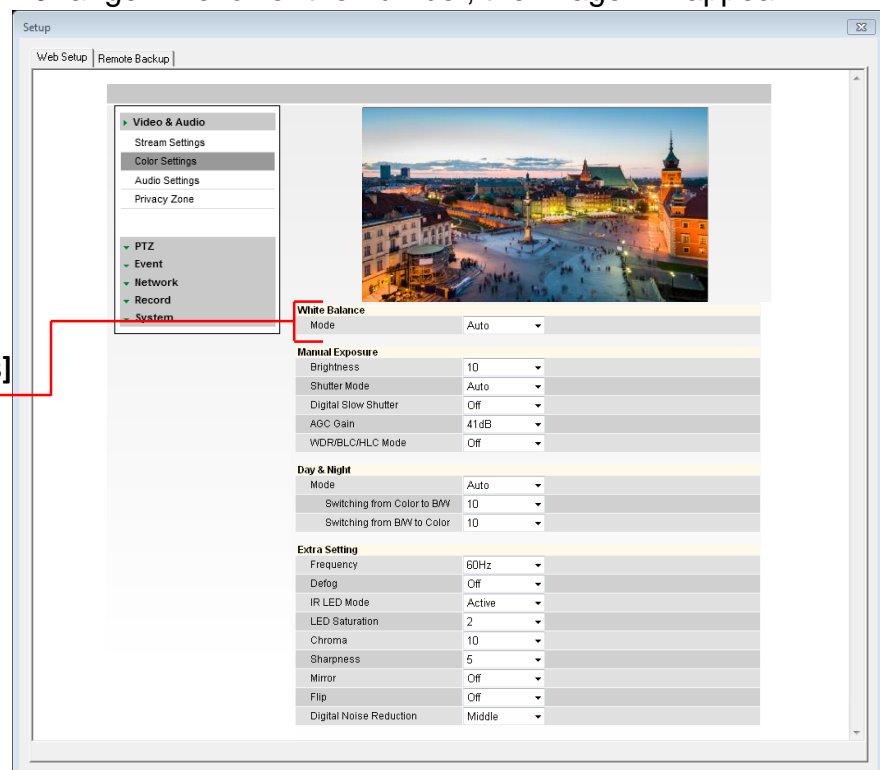

# WEBVIEWER\*

## Setup > Video > Color Settings

Use the color settings menu to adjust the camera to its unique lighting environment and to get the best image quality.

**Manual Exposure:** Set Brightness, Shutter Mode, Digital Slow Shutter Speed, AGC, BLC, & WDR.

- > **Brightness**- Set the brightness of the camera's image from 0~20. The higher the number, the brighter the camera's image will appear. Default value is 10.
- > **Shutter mode**- Set the camera's shutter mode to Auto or manual. If manual is selected, select the shutter speed. Select from the available options between 1/30 and 1/60000. Select 1/30 to set more exposure time to light. This setting is used to make movements look natural/ unfrozen. Select 1/60000 to set less exposure time to light. This settings is used to catch fast moving objects.
- > **Digital Slow Shutter**- Slow shutter mode decreases the shutter speed in low light to improve the image quality. Set the camera's digital slow shutter for: Off, 2x ~ 8x. The smaller the value the darker the image will appear.

[Manual Exposure Settings]

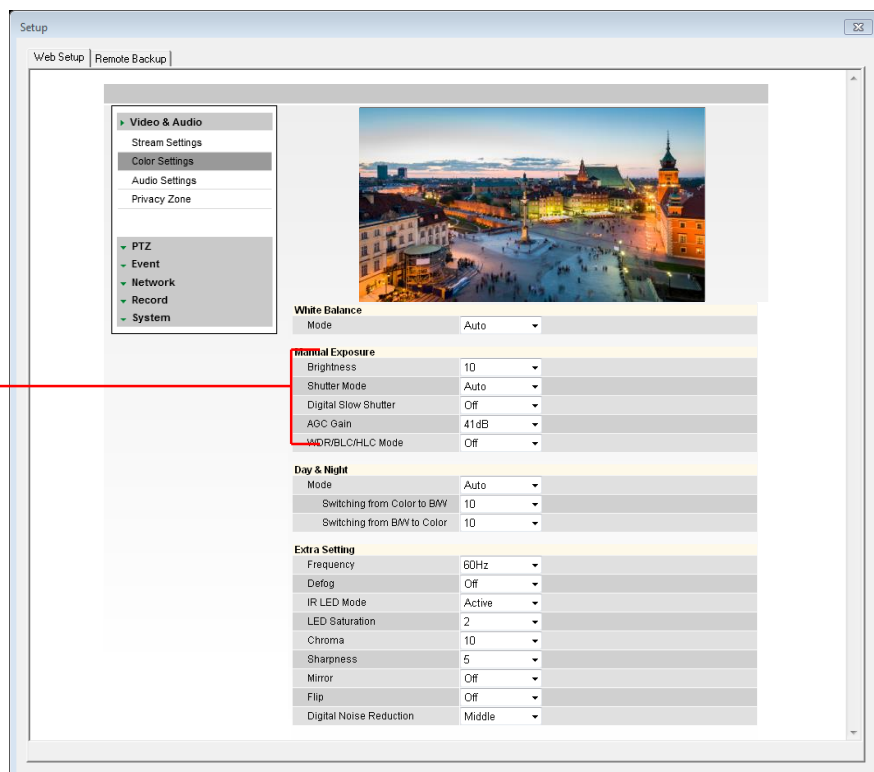

# WEBVIEWER\*

## Setup > Video > Color Settings

Use the color settings menu to adjust the camera to its unique lighting environment and to get the best image quality.

**Manual Exposure:** Set Brightness, Shutter Mode, Digital Slow Shutter Speed, AGC, BLC, & WDR.

- › AGC Gain- Maximum light gain settings in low light conditions. Select from 0dB (least light) to 41dB (most light). Default value is 41dB.
- › HLC [Highlight Compensation]- Masks highlights for objects to appear clearly on the screen.
- › BLC [Backlight Compensation]- This setup option allows you to adjust the camera's capture of light when there is strong backlight in the camera's Field of View [FoV].
- › WDR [Wide Dynamic Range]- the Wide Dynamic Range is used when there are extremely bright and extremely dark areas in the VoF of the camera. If WDR is selected, select the WDR level from: Low, Middle, High. Default is Middle.

**Day & Night Settings:** control the camera's Day & Night Mode.

- › Day & Night- Set mode to Night (B/W), Day (Color), or Auto.
- › COLOR → B&W: The higher the number, the lower the light level.
- › B&W → COLOR: This number should be lower than the value of COLOR → B&W above. **[Manual Exposure Settings]**

**[Day & Night Settings]**

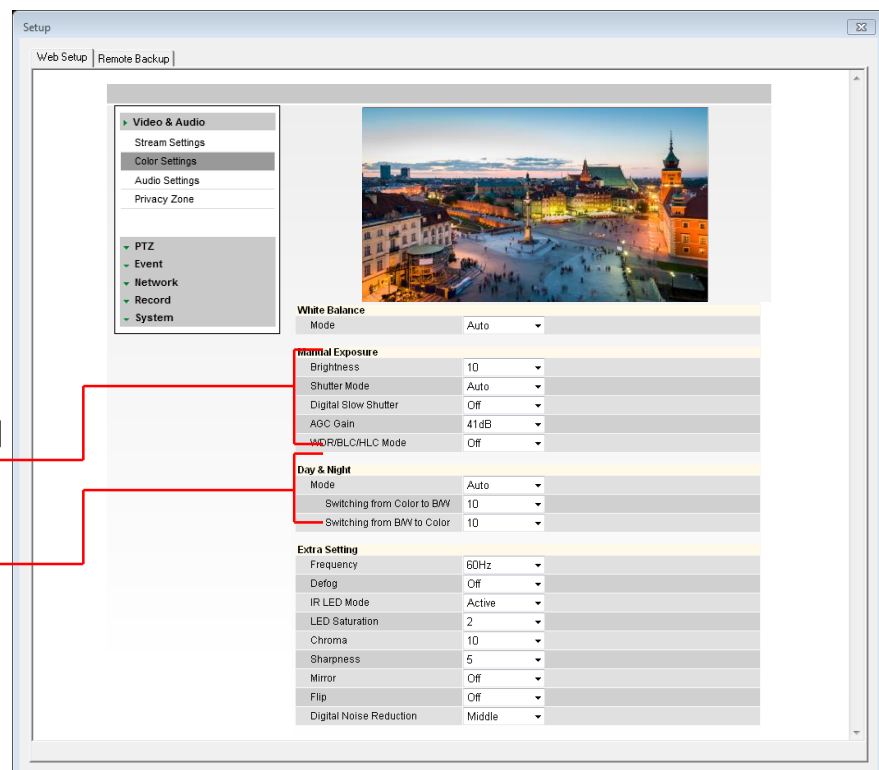

# WEBVIEWER\*

## Setup > Video > Color Settings

Use the color settings menu to adjust the camera to its unique lighting environment and to get the best image quality.

**Extra Settings:** control the camera's Day & Night Mode, Focus, WDR, Flip, Digital Zoom, Aperture Level, and Noise Reduction.

- > Frequency- In case the camera's image is flickering, adjust the value on this setting.
- > Defog- Sharpens the camera's image to compensate for blurry view due to weather conditions.
- > IR LED Mode- this function is for smart IR adjustment. Turn Smart IR On (Active), or Off (Inactive).
- > LED Saturation- This is a Smart IR feature, controlling the saturation level in the image created by the IR LED reflection from objects in the camera's view.
- > Chroma- Chroma settings affect the color quality including both hue and saturation. Black, white, and gray colors have 0 Chroma. Higher numbers accentuate brighter colors.
- > Sharpness- Sets the image sharpness. The higher the number, the sharper the image.
- > Mirror- reflect the image from left to right.
- > Flip- Select On or Off to flip the image upside down.
- > Digital Noise Reduction- Control the level of noise in the image. Select from Off, Level 1 – Level 5. The higher the level, the more the camera will manipulate the image to reduce digital noise, but it will also increase lagging when motion occurs.

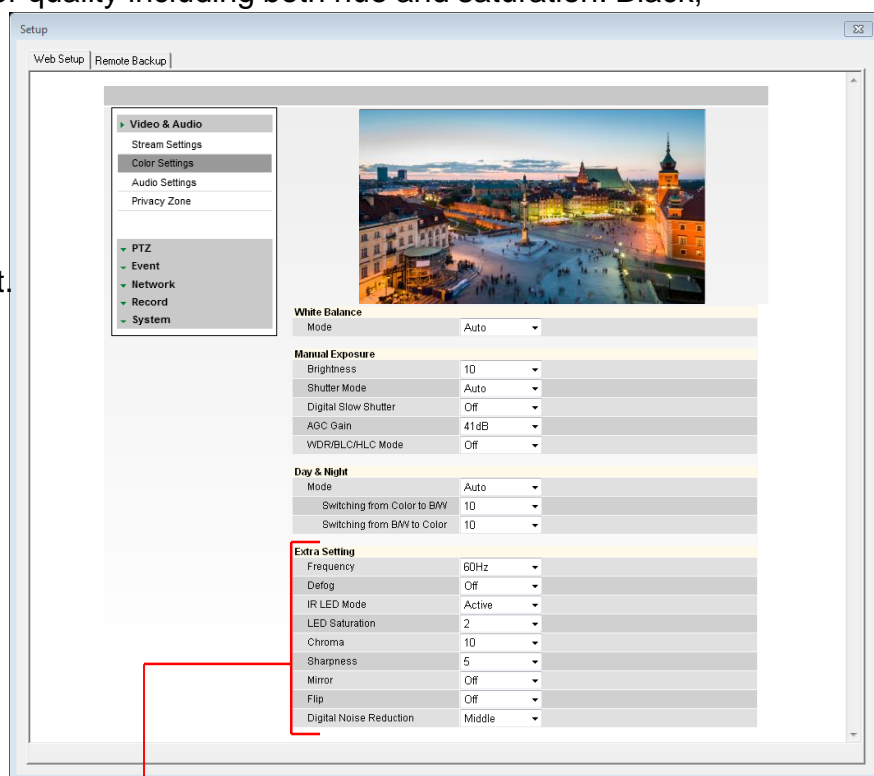

[Extra Image Settings]

# WEBVIEWER\*

## Setup > Video > Privacy Zone

The MEGApix camera offers up to 16 privacy zones. To set Privacy Zones:

### Global Settings:

1. Change Mode to On and click Apply. By default, all 16 privacy zones will be displayed.
2. Adjust the mask's color by changing the Y, Cb, and Cr values. Click Apply to view the changes.  
Y: Adjust the Brightness of the mask's color. The higher the number, the brighter the color.  
Cb: Adjust the blue color levels of the mask.  
Cr: Adjust the red color levels of the mask.  
Hover your mouse over the Color section for a complete list of values for common colors such as Black, White, Cyan, Magenta, Blue, Green, Yellow, Red, Gray, and Purple.
3. Select the zones you want to view. Use the 'Show All' button to display all 16 privacy zones, or 'Hide All' to deselect them. After selecting the privacy zone you want to modify, click Apply.

### Local Settings:

4. Chose which privacy masking you want to modify. Click 'Apply'.
5. Set the zone's size and location, using the grid lines.  
Horizontal Position: 0~59.  
Vertical Position: 0~33.  
Width: 1~60.  
Height: 1~34.
6. Click 'Apply' after each modification to verify the size and position match your requirements.
7. Click 'Reload' to make sure your changes have been applied.

The screenshot displays the 'Privacy Zone Settings' interface. On the left, a navigation menu has 'Privacy Zone' selected. The main area shows a 4x4 grid of 16 zones over a city scene. Below the grid are 'Global Settings' and 'Local Settings' sections. The 'Global Settings' section includes a 'Mode' dropdown set to 'Off', an 'Apply' button, and color adjustment fields for Y (20), Cb (20), and Cr (0). A 'Display Zone' section has 16 checkboxes, all of which are checked. The 'Local Settings' section includes a 'Zone' dropdown set to 'Zone 1', an 'Apply' button, and input fields for 'Horizontal Position' (12), 'Vertical Position' (2), 'Width' (3), and 'Height' (3). A 'Reload' button is located at the bottom right.

# WEBVIEWER\*

## Setup > Event > Motion Detection

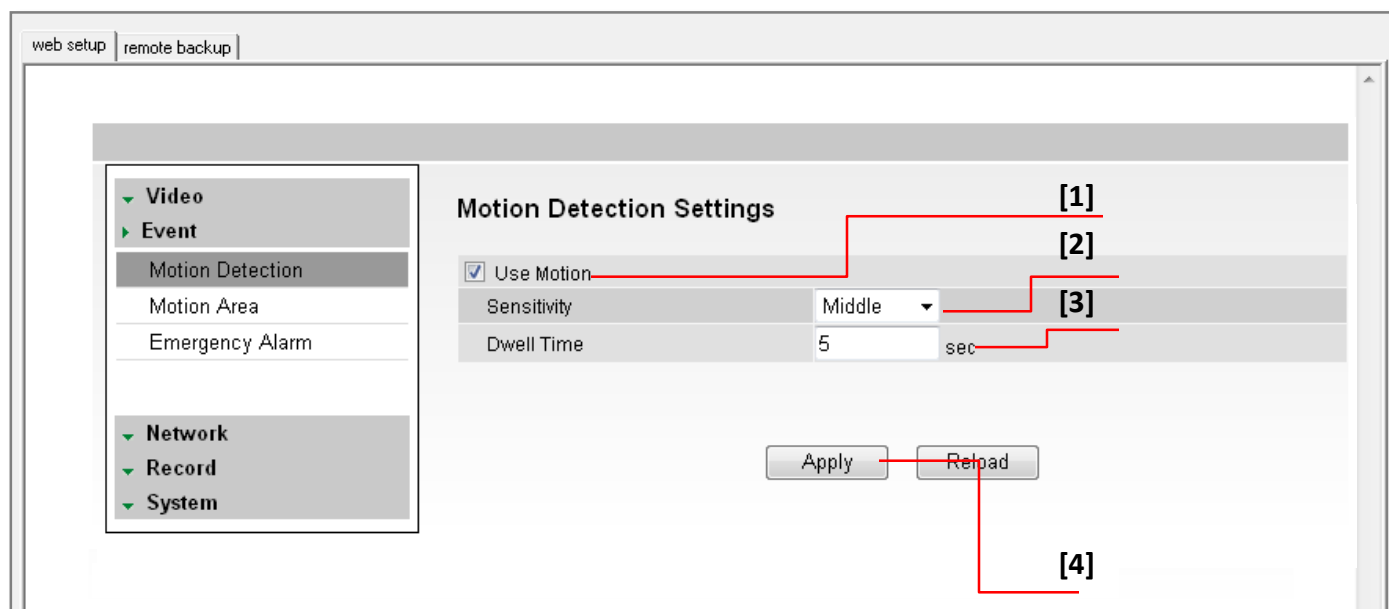

The Motion detection feature allows the MEGApix camera to detect motion and trigger an alarm. To set the camera to send e-mail notifications for every motion triggered alarms, see page 45.

1. Check the **Use Motion** box.
2. Sensitivity- Select from Low, Middle, or High.
3. Dwell Time- When a motion is triggered, the camera can be set to record for a certain period of time. Dwell Time can be set up to 900 seconds.
4. Select **Apply** to save changes.

To setup specific areas of the camera's view to motion detection, please see the next page.

# WEBVIEWER\*

## Setup > Event > Motion Area

The Motion detection feature allows the MEGApix camera to detect motion and trigger an alarm. To set the camera to send e-mail notifications for every motion triggered alarms, see page 45.

1. Using the virtual joystick next to the camera's preview screen, move the camera to the position you would like to set for motion detection.
2. Hold left mouse button and drag the mouse pointer over image to select the motion area, or use Set All button to select the entire screen.
3. Select Clear All to deselect motion areas.
4. Select **Apply** to save changes.

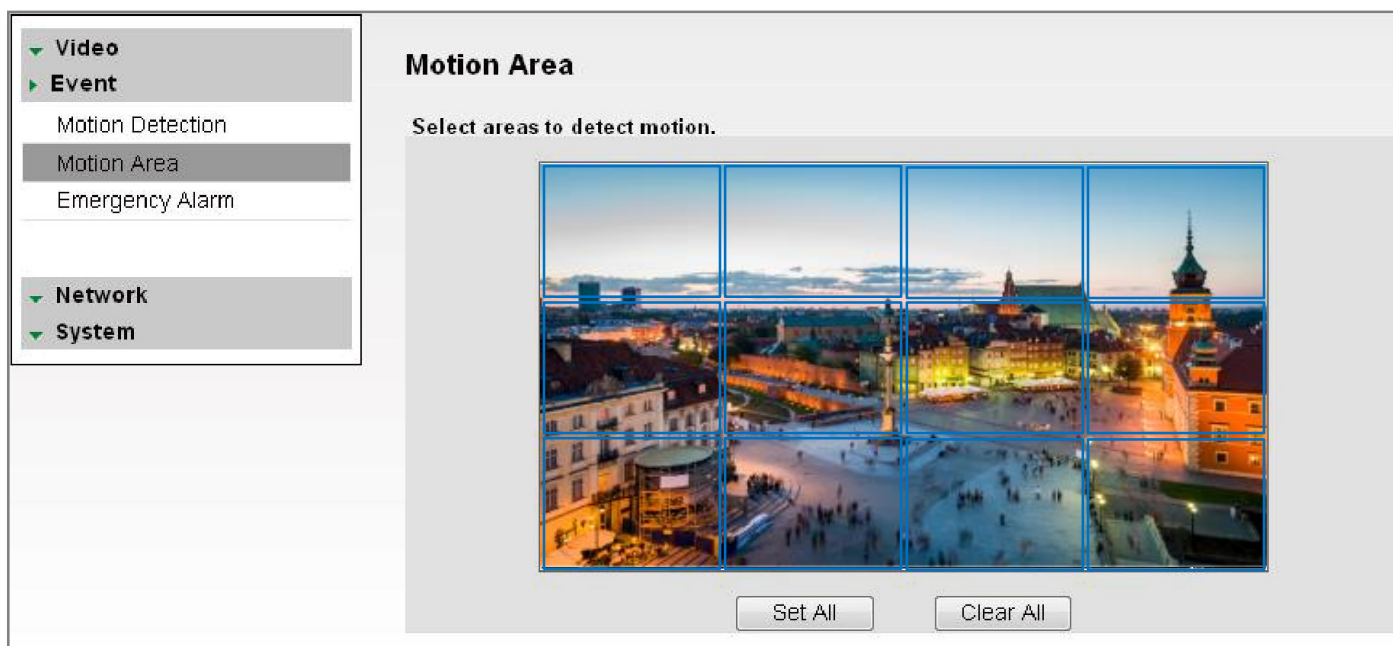

# WEBVIEWER\*

## Setup > Event > Emergency Alarm

The Emergency Alarm option allows the camera to send a notification when an alarm is triggered to a predefined destination (i.e. remote client software).

1. Site Information- Site Name, Transmission Settings, and Video Duration for the video that will be sent when motion is detected.
2. Emergency Alarm Recipient List- Enter the IP address and the Port for the remote site(s) to which you want to send the video. You can set-up up to five different servers. You must set same port to get EACH data.
3. Select **Apply** to save changes.

[Site Information]

[Emergency Alarm Recipient]



# WEBVIEWER\*

## Setup > Network > Network Settings

Use this setup page to adjust the camera's network settings, including the IP address, DNS information, and ports. In the IP Mode section, select the type of IP address for the camera.

1. DHCP- Select if using a DHCP Server and camera will to obtain an IP address automatically.
2. PPPoE- Select when using a WAN service. Enter a Username and Password from your ISP.
3. Static IP- Enter IP information if you decided to give the camera a static (fixed) IP address.
  - a. IP Address- Enter the static IP Address of the camera
  - b. Subnet Mask- default is 255.255.255.0
  - c. Gateway- your router's external (public) IP address. It is used when accessing the camera from outside the network. The router will channel your data to the correct destination even if it is on a different subnet mask.
  - d. To obtain a static IP Address and network information, contact your Internet Service Provider or Network Administrator.
4. DNS- Enter Primary DNS and Secondary DNS. The Domain Name Server translates web addresses to IP addresses.
5. IPv6 Mode- IPv6 offers a new 128-bit address system.
6. MAC Address- Displays the camera's Mobile Access Control Address.
7. Port- Displays all the ports necessary for communication and router setup.
8. Use Flow Control- Control the network stream (quality & Frame rate) pending on the network circumstance.
9. Select '**Apply**' to save all changes and reboot the server.

The screenshot shows the 'Network Settings' page in a web browser. The interface is divided into several sections: 'Network Settings', 'DNS', 'IPv6 Mode', 'PORT', and 'Miscellaneous'. Red lines and numbers [1] through [8] are overlaid on the image to highlight specific fields. [1] points to the 'Network Settings' title. [2] points to the 'IP Mode' section. [3] points to the 'Username' field. [4] points to the 'IP Address' field. [5] points to the 'IPv6 Mode' section. [6] points to the 'Auto' radio button and the IPv6 address field. [7] points to the 'Command Port' field. [8] points to the 'Use Flow Control' checkbox. The 'Static IP' mode is selected, with fields for IP Address (64.239.139.112), Subnet Mask (255.255.255.224), and Gateway (64.239.139.97). The 'DNS' section has a Primary DNS field (188.126.63.1). The 'IPv6 Mode' section has 'Not Use' selected. The 'PORT' section has Command Port (7000), Live Port (7001), Web Port (80), and Recording Port (7004). The 'Miscellaneous' section has 'Use Flow Control' unchecked. 'Apply' and 'Reload' buttons are at the bottom.

# WEBVIEWER\*

## Setup > Network > Dynamic DNS

If you do not use a public IP address, DDNS provides you to connect on WAN. DDNS allows you to connect to the MEGApix camera with a URL address instead of an IP address. DDNS automatically redirects traffic to your IP address every time it changes. DW's MEGApix cameras offer free DDNS services using the DVR.NAME server option.

1. To use DDNS, select the Use DDNS checkbox.
2. To use Digital Watchdog's free DDNS service, you must register your camera with Digital Watchdog's technical support. Please contact our Technical Support by calling 1-866-446-3595.
3. Select one of the DDNS System Names from the drop down list. Default DDNS server is DVR.NAME, the free DDNS service provided by Digital Watchdog for the MEGApix cameras.
4. Enter Username & Password as registered with Digital Watchdog's Technical Support Team.
5. Enter Host Name. The Host name should be the same as the domain name.
6. Click 'Apply' and reboot the camera. System will automatically restart and may take up to 20 seconds to reboot.

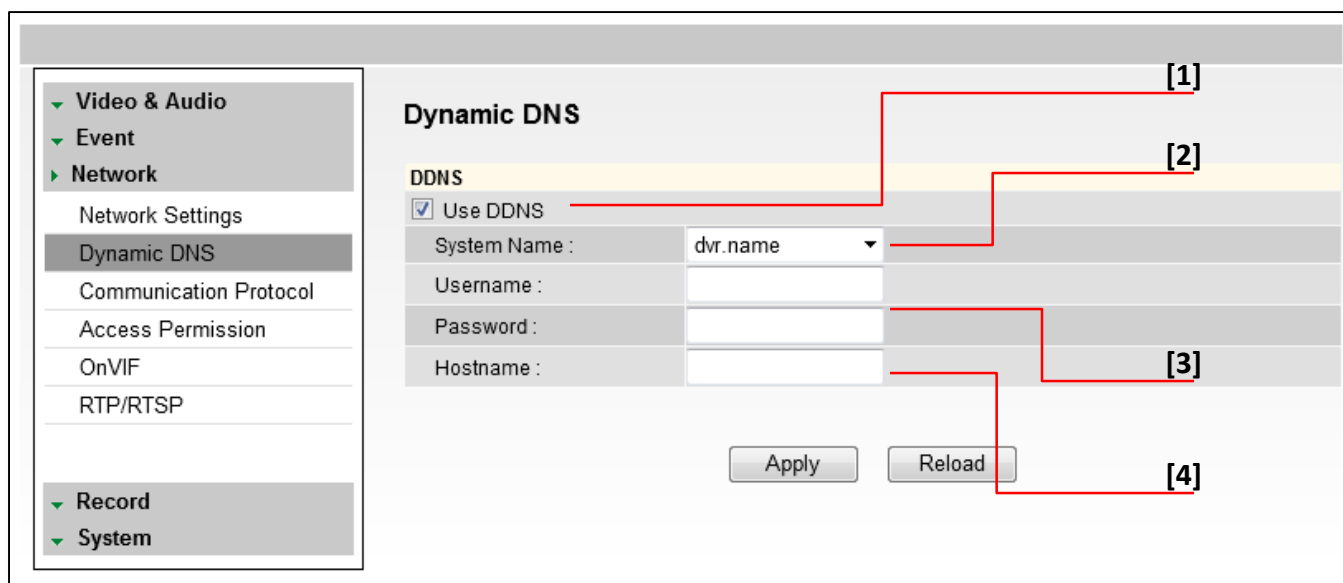

# WEBVIEWER\*

## Setup > Network > Communication Protocol

Current Protocol displays the current selected protocol.

1. To change the Protocol, select one of the three options—TCP, UDP, or Multicast.
2. If you select Multicast, enter the Multicast IP and Multicast Port.
3. Reboot your system to apply the changes to your camera. To Reboot, select Apply. A dialogue box will appear, select OK. System will automatically restart and may take up to 20 seconds to reboot.

The screenshot displays the 'Communication Protocol' configuration interface. On the left, a sidebar menu is visible with categories: Video & Audio, Event, Network (expanded), Record, and System. Under 'Network', the following options are listed: Network Settings, Dynamic DNS, Communication Protocol (highlighted), Access Permission, OnVIF, and RTP/RTSP. The main content area is titled 'Communication Protocol' and contains the following fields and controls:

- Current Protocol :** TCP [1]
- Protocol :**  TCP  UDP  Multicast
- Multicast IP :** [Empty text input field] [2]
- Multicast Port :** 0

At the bottom of the configuration area, there are two buttons: 'Apply' and 'Reload'.

# WEBVIEWER\*

## Setup > Network > Access Permission

Use the Access Permission page to allow or block specific IP addresses to connect to the camera.

1. Select Allow All to allow anyone to connect to this camera. If Allow All is selected, the Allowed IP List and Blocked IP List will be ignored.
2. To allow only a specific list of IP addresses to connect to this camera, select Allow. Enter an IP Address and click the Add button.
3. To block a specific list of IP addresses from connecting to this camera, select Block. Enter an IP Address and click the Add button.

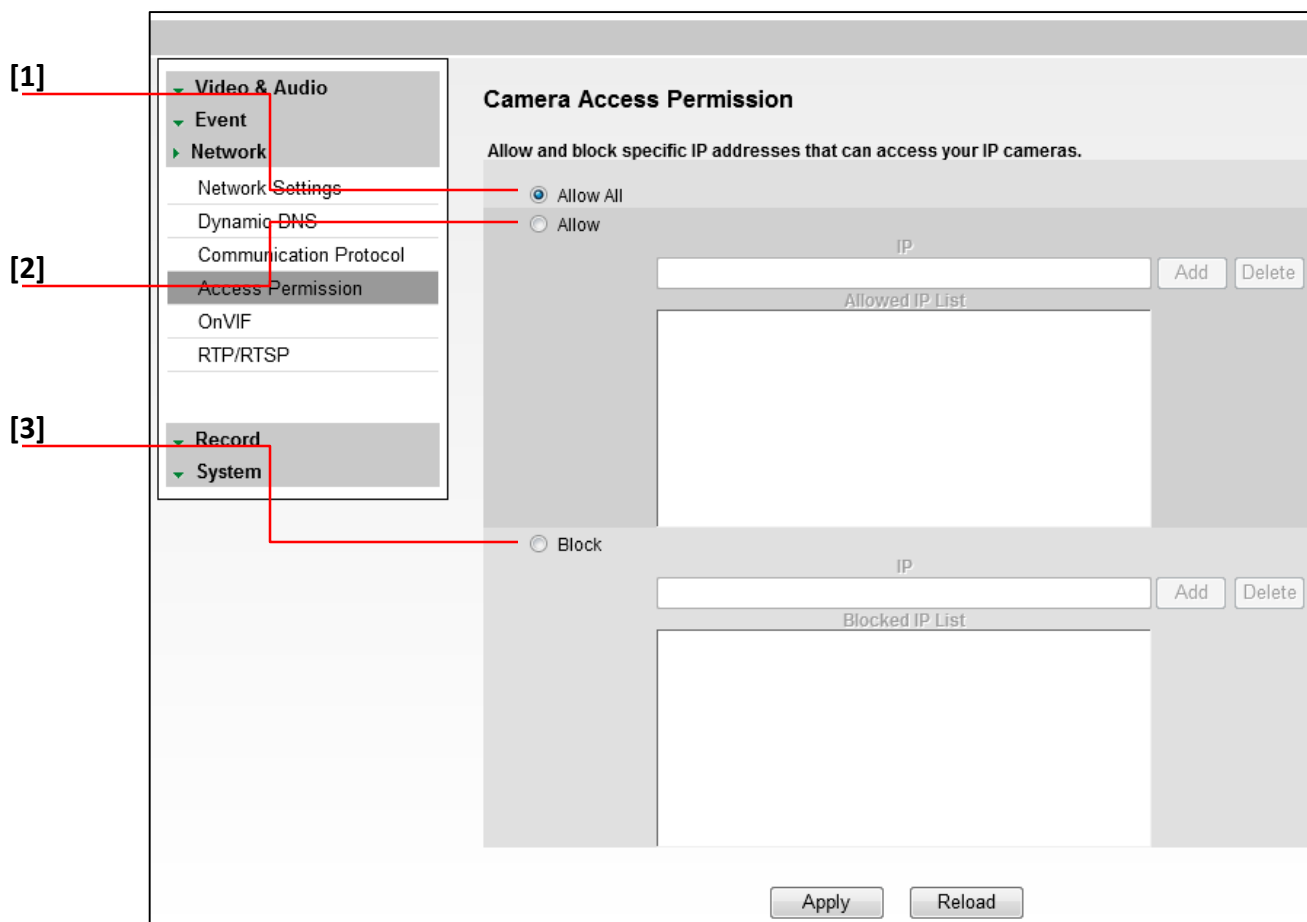

# WEBVIEWER\*

## Setup > Network > OnVIF

OnVIF is the Open Network Video Interface Forum.

1. To use OnVIF, check Enable.
2. Select the number of streams the camera will be sending using the OnVIF protocol. This may vary depending on the software and server you use. Consult your NVR's manual for additional information. The camera will be set to dual stream on OnVIF by default.
3. Service Port will be set by default to "8032." This is the camera's OnVIF port. Use this port information when connecting the camera to a server using the OnVIF protocol.
4. Select On or Off to Authenticate Address.
5. Select On or Off for WS-Discovery (Web Services Dynamic Discovery)
6. Select Apply to save changes.

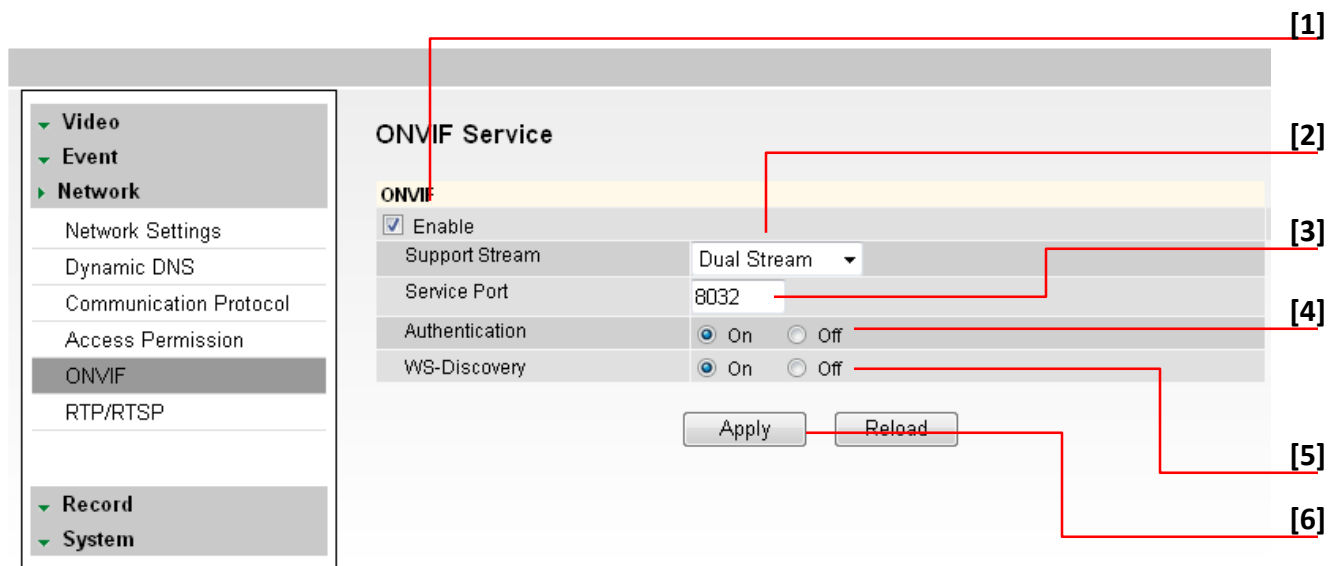

# WEBVIEWER\*

## Setup > Network > RTP/ RTSP

Real-time Transport Protocol (RTP) and Real-time Streaming Protocol (RTSP) are data transfer protocol for delivering live and stored media to one or more clients at the same time. These protocols allow software to access the first and second stream directly, by assigning each stream its own ports. RTP and RTSP are used for integration and communication between the cameras and other software.

To use RTP/ RTSP:

1. Check the box to enable authentication on RTSP
2. If necessary, modify the ports for the first and second stream.
3. Click '**Apply**' so save all changes or 'Reload' to view the last saved settings.

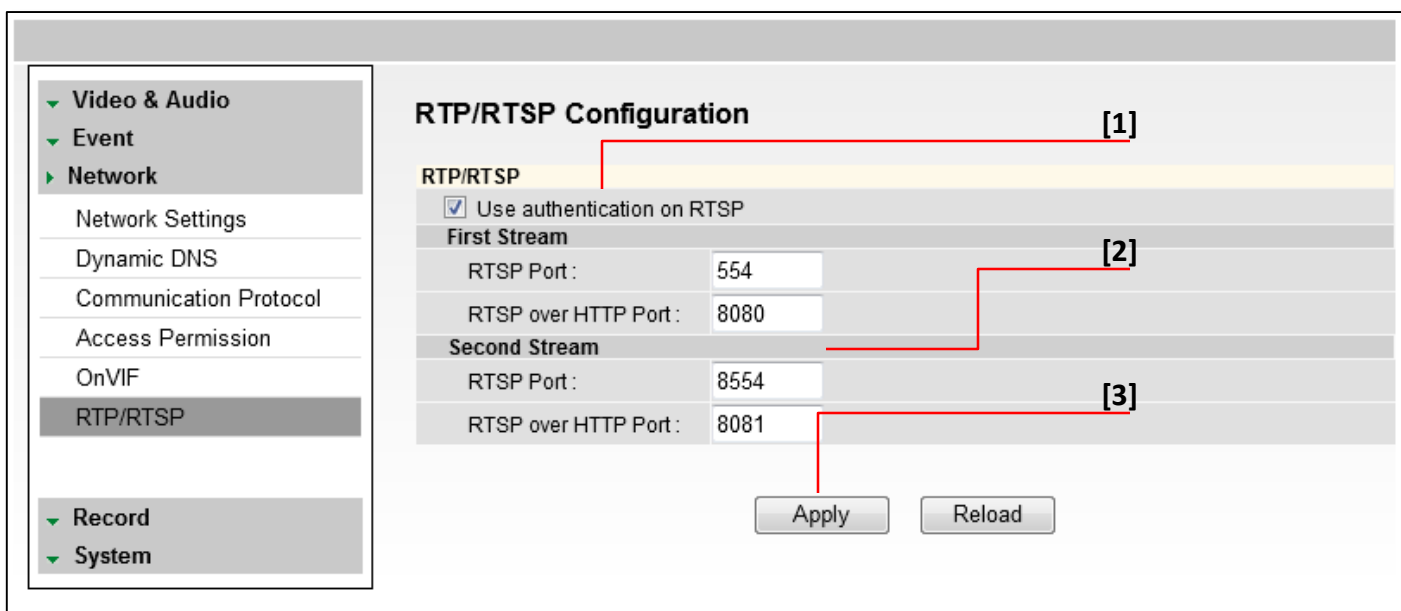

# WEBVIEWER\*

## Setup > Record > Storage Device

### Device Information

1. Click the icon Load Device Information to find the SD card connected to the camera.
2. The system will display all storage devices currently connected to the camera.
3. To activate the SD card to start recording, select Record Start.
4. To stop the SD card's recording, select Record Stop.
5. To safely remove the SD card, select 'Device Eject'.
6. To delete all content on the SD card, select 'Format Device'. NOTE: all data stored on the SD card will be erased.

### Recording Information

7. This section displays the first and last recorded data available on the selected SD card. The SD card records video from the second stream. To modify recording quality, please see page 42.

The screenshot shows the 'Storage Device Configuration' web interface. On the left is a navigation menu with 'Record' > 'Storage Device' selected. The main area is titled 'Storage Device Configuration' and contains a 'Device Information' section with a 'Load Device Information' button and a table. Below the table is a 'Current Recording Partition' field and four buttons: 'Record Start', 'Record Stop', 'Device Eject', and 'Format Device'. At the bottom is a 'Recording Information' section with 'Recording Start Time' and 'Recording End Time' fields. Red callout boxes [1] through [7] point to the following elements:

- [1] Video & Audio menu item
- [2] Record menu item
- [3] Storage Device menu item
- [4] Load Device Information button
- [5] Table with columns: Partition, Size (MB), Free (MB), Recordable, Recording
- [6] Recording Start Time field
- [7] Recording End Time field

Partition	Size (MB)	Free (MB)	Recordable	Recording
A01	3720	10	o	

**IMPORTANT:** The SD card recording function operates as an emergency recording, designed to record video from the camera only when there is a network loss. If you connect to the camera via the Web viewer or an NVR, the SD card recording will stop.

# WEBVIEWER\*

## Setup > Record > Schedule

The recording schedule applies to the SD card local recording. When the camera detects a network loss, it will start recording backup video to the SD card based on the schedule setup.

### Video Schedule

1. Set recording schedule daily or weekly. Default is daily setting. It only saves single day's setting without changing to 'Multi Day Mode.'
2. Select the type of recording: Continuous (Cyan), Motion (Yellow) & Sensor (Red) by clicking on the corresponding button.
3. Drag your mouse over the hours you want to set for motion recording. The recording mode will be applied to the hours you selected when you release the mouse's right-click.
4. To remove scheduled recording for a specific day, select 'No Record' and press the box for which hours you want the recording removed. The box will now appear white.
5. Select Apply to save changes, or Reload to view the last saved settings.

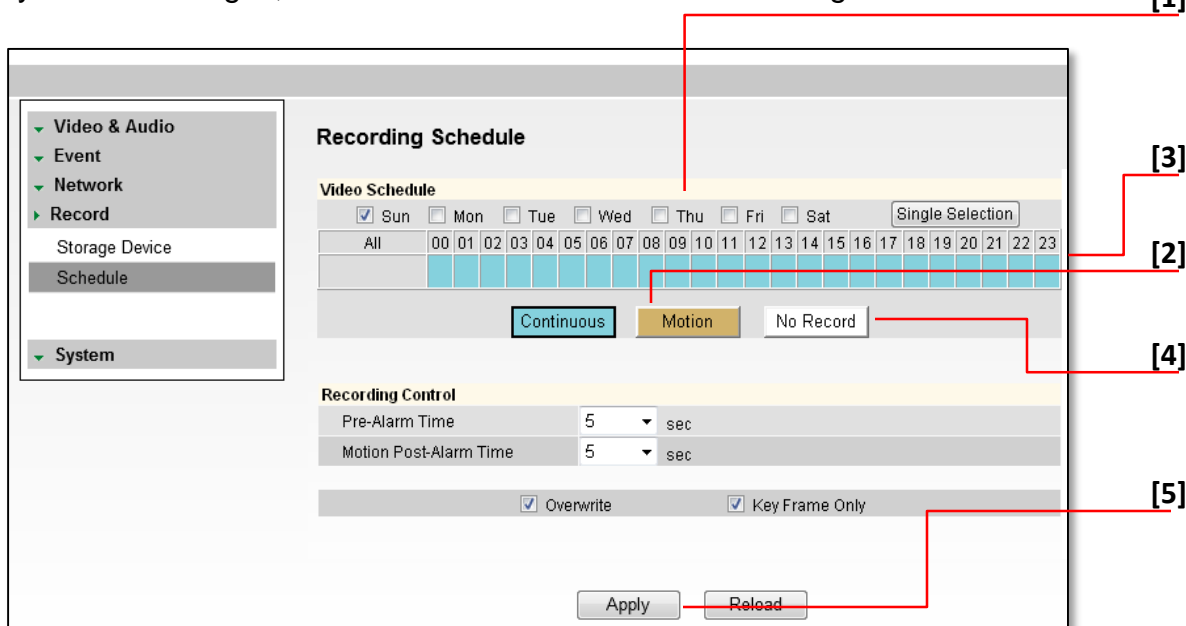



# WEBVIEWER\*

## Setup > Record > Schedule

The recording schedule applies to the SD card local recording. When the camera detects a network loss, it will start recording backup video to the SD card based on the schedule setup.

### Recording Control

6. Pre-Alarm Time- Save previous image of event for duration of time.
7. Motion Post-Alarm Time- Save images after motion events for duration of time.
8. Overwrite- If selected, once the SD card is full, new video will be recorded over older data.
9. Key Frame Only- If selected, the SD card will record only Start and End Key Frame, the main frames in the series. This option is recommended when you have limited storage space.
10. Select Apply to save changes.

The screenshot shows the 'Recording Schedule' configuration page. On the left is a navigation menu with 'Record' expanded to show 'Storage Device' and 'Schedule'. The main area is titled 'Recording Schedule' and contains two sections: 'Video Schedule' and 'Recording Control'. The 'Video Schedule' section has a weekly selection row with 'Sun' checked, a 'Single Selection' dropdown, and a 24-hour grid. Below this are three buttons: 'Continuous', 'Motion', and 'No Record'. The 'Recording Control' section has two rows: 'Pre-Alarm Time' and 'Motion Post-Alarm Time', both set to 5 seconds. Below these are two checked checkboxes: 'Overwrite' and 'Key Frame Only'. At the bottom are 'Apply' and 'Reload' buttons. Red lines connect callouts [6] through [10] to the following elements: [6] to 'Schedule' in the menu, [7] to 'Motion Post-Alarm Time', [8] to 'Overwrite', [9] to 'Key Frame Only', and [10] to the 'Apply' button.

# WEBVIEWER\*

## Setup > Remote Backup Tab

The MEGApix Series allows you to back up your SD card locally to your computer without the need to remove it from the camera.

1. Go to the Remote Backup Tab in the camera's Setup menu.
2. On the calendar, select the date for remote backup.
  - a. Days with recorded data will be indicated in **BOLD**.
  - b. Hours with recorded data on them will be indicated by the pink line in the time bar.
3. Select the Backup Start Time and Backup End Time.
4. Select the Target Drive. The Target Drive is where the remote backup will be saved.
5. You can also use the interactive time bar.
  - a. Right-click on the time you want to set as Start Time.
  - b. Left-click on the time you want to set as End Time.
  - c. The time frame you have selected will appear in BLUE.
6. Select Backup Start. To cancel a backup in progress, select Backup Cancel.

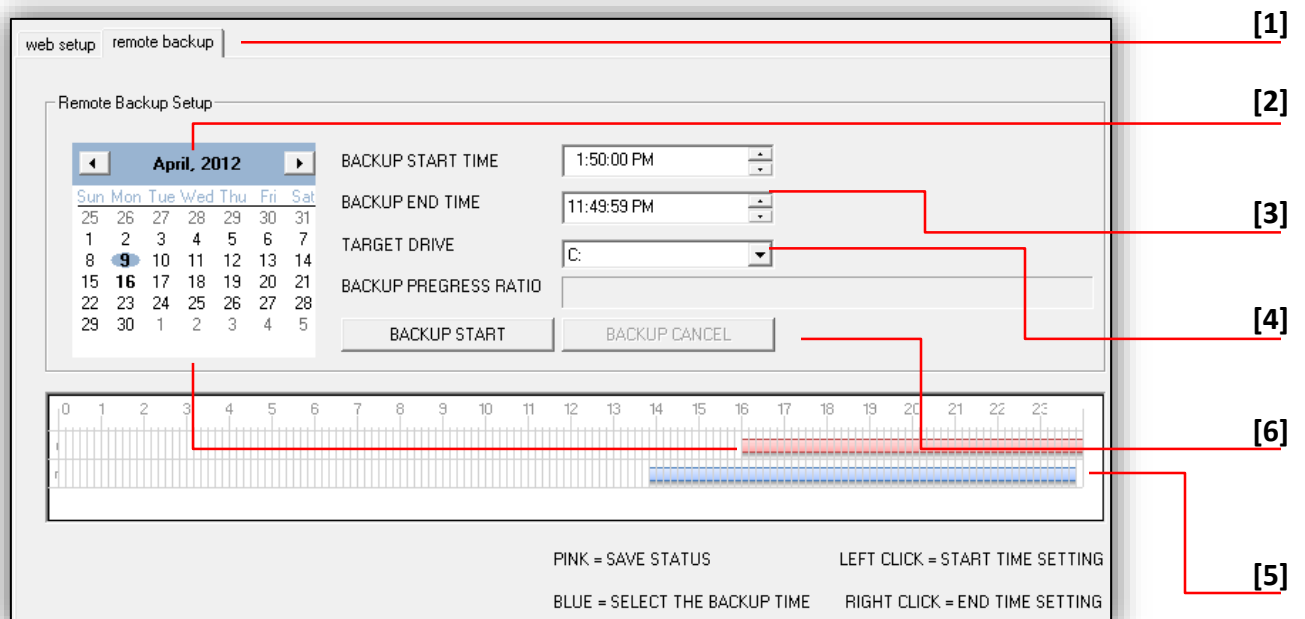

# WEBVIEWER\*

## Setup > System > Upgrade

Upgrade the MEGApix camera and reset it to factory default.

Camera Information- Shows the camera's model name, current firmware, Kernel, and Server versions, and the camera's internal Flash size memory. This is the camera's internal memory necessary, for the camera's operation, and cannot be used for recording locally.

Manual Upgrade- To upgrade system firmware, you have to contact manufacturer and get the upgrade file first. Go to [www.Digital-Watchdog.com](http://www.Digital-Watchdog.com) and select Support tab.

- a. Browse file and select the file and press 'Upgrade'. The system will automatically reboot.

FTP Upgrade-

- a. Server Address- FTP Server IP address.
- b. Port- Default is 21.
- c. User ID and Password- FTP Server Log in ID and Password.
- d. Directory- Upgrade File Path.
- e. Action- Select Check Upgrade to display the Upgrade File list.
- f. Status- Display upgrade progress.

Factory Reset- Reset the camera to its original factory settings.

- a. 'General'- reset to factory default on all settings except Network settings.  
Full'- will reset ALL of the camera's settings. **[Manual Upgrade]**

**[FTP Upgrade]**

**[Factory Default]**

The screenshot displays the 'System Management' interface. On the left is a navigation menu with 'System Management' selected. The main content area is divided into four sections:

- Camera Information:** Model Name: DWC-MB721M4TIR, Firmware Version: 1.1, Kernel Version: 2.1.0.0, Server Version: 2.1.0.3, Flash Size: 128 MB.
- Manual Upgrade:** Fields for Kernel Upgrade and Server Upgrade, each with a 'Browse...' button and an 'Upgrade' button. An 'Upgrade Status' field is also present.
- FTP Upgrade:** Fields for Server Address (ftp.digital-watchdog.com), Port (21), User ID (dwmpix), Password (masked with dots), and Directory (/FTP/firmware\_megapix). Action buttons include 'Check Upgrade', 'Apply', and 'Reload'. A 'Status' field is at the bottom.
- Factory Default:** A 'Mode' section with radio buttons for 'General' (selected) and 'Full', and a 'Run' button. A 'System Reboot' button is located at the bottom center of the interface.

# WEBVIEWER\*

## Setup > System > Date & Time

Set date and time information.

1. Insert the Date and Time. Select the type of Format for your time.
2. To synchronize with the NTP Server, select the option and type the NTP Server Address.  
Example: pool.ntp.org.
3. Select your Time Zone.
4. Select Apply to save changes.

**Date& Time**

**Time Mode**

Manual

Date : 2013 / 1 / 25 (YYYY/MM/DD)

Time : 16 : 22 : 7

Format : 24 HRS

**Synchronize with NTP server**

Synchronize with NTP server

NTP Server Address : time.windows.com

Update Status :

**Timezone**

Timezone : (GMT -05:00) Eastern Time (US & Canada)

Automatically adjust clock for Daylight Saving Time

# WEBVIEWER\*

## Setup > System > E-mail Notification

Send an e-mail notification from the camera based on events such as sensor activation, motion detection, camera reboot or upgrade.

1. Select Use Event Mail option. Select Event Type.
2. Enter SMTP Server information. Example: smtp.gmail.com.
3. Enter Username and Password.
4. Enter Sender E-mail.
5. Add the E-mail(s) you wish to send the notifications to.
6. Select Apply to save changes.

The screenshot shows the 'Event and Alarm Email Notification' configuration page. On the left, a sidebar menu has 'System' expanded, with 'Email Notification' selected. The main area contains the following fields and options:

- Use Event Mail
- Events :  Sensor  Motion  Relay  Reboot  Upgrade
- SMTP Server : [2]
- Username : [3]
- Password : [3]
- Sender E-Mail : [4]
- E-Mail List : [4] (with Add, Modify, Delete buttons)

At the bottom, there are 'Apply' and 'Reload' buttons. Red lines and numbers [1] through [6] indicate the steps for configuration:

- [1] points to the 'System' menu item.
- [2] points to the SMTP Server field.
- [3] points to the Username and Password fields.
- [4] points to the Sender E-Mail and E-Mail List fields.
- [5] points to the 'Email Notification' menu item.
- [6] points to the 'Apply' button.

\* Email Notifications do not support TSL/SSL option. Notifications are TEXT only.

# WEBVIEWER\*

## Setup > System > User Access Control

To add a new user:

1. Enter Username and Password.
2. Select a Permission type.
  1. Super- Administrator
  2. Operator- View and Edit Video and Event Settings Only
  3. Viewer- View Only
3. Click Add.
4. To modify a user, select the user from the User List, and click Modify.
5. To remove a user, select the user from the User List, and click Remove.
6. Select Apply to save changes.

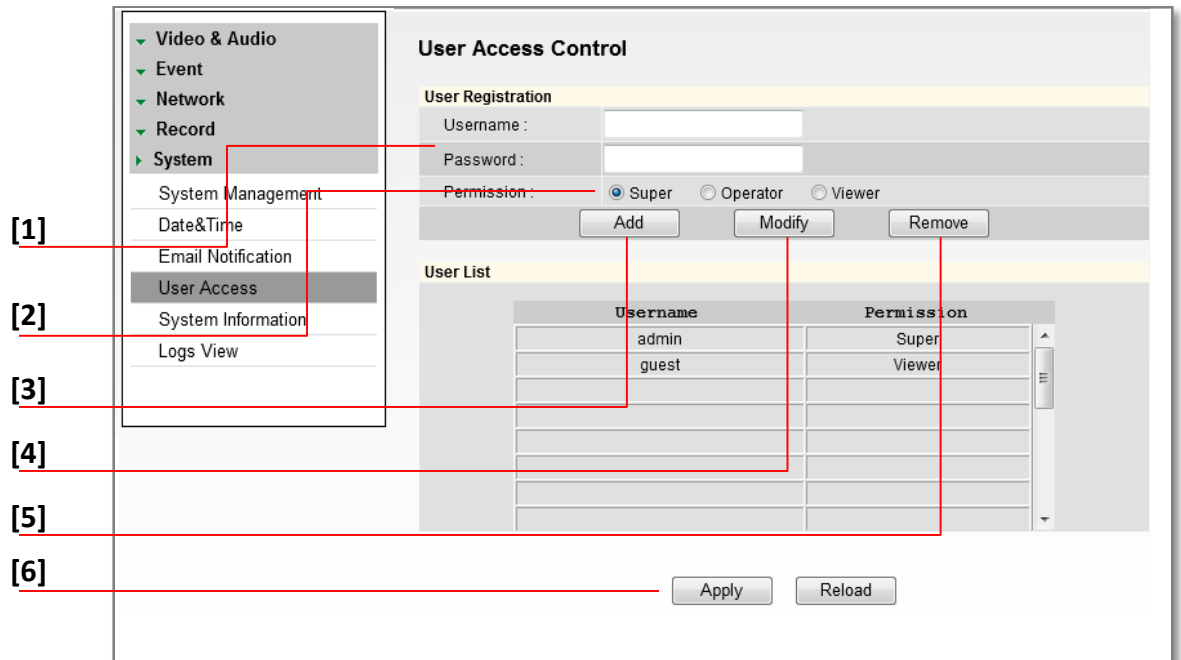

\* The maximum number of users (including admin) is twenty.

# WEBVIEWER\*

## Setup > System > System Information

System Information will display all the current camera settings: System Version, Time Information, Network Information, and Stream Information.

You can export a camera's settings to apply to other cameras by using the import/ export buttons on this page.

To Export the settings from the current camera:

Press the export button. The system will generate a '.bin' file with all the cameras settings in your Internet Explorer 'Downloads' page.

To import settings from a different camera Press the Browse button and locate the '.bin' file you have imported from a different camera.

Select the 'Import' button. The system will update the current camera's settings with all the imported information.

The progress bar will display the import process.

The screenshot displays the 'System Information' page in a web browser. On the left is a navigation menu with the following items: Video & Audio, Event, Network, Record, System (selected), System Management, Date&Time, Email Notification, User Access, System Information (highlighted), and Logs View. The main content area is titled 'System Information' and contains several sections:

- Configuration Import/Export:** Includes an 'Export Configurations' button, a 'Configuration Import' field with a 'Browse...' button and an 'Import' button, and a 'Status' field.
- System Version:** A checked section containing a table:

Camera Firmware	4.3
Kernel Version	1.0.0.0
Server Version	1.1.0.1
- Time Information:** An unchecked section.
- Network Information:** A checked section containing a table:

IPv4 Mode	Static (72.243.193.200)
DNS	168.126.63.1 4.2.2.5
IPv6 Mode	Not Use
MAC Address	00:1C:A6:01:21:8E
Port	
Command	7000
Live	7001
Web	80
Dynamic DNS	Not Use
Communication Protocol	TCP
- Stream Information:** An unchecked section.
- Color Information:** A checked section containing a table:

White Balance	Auto
Brightness	16
Shutter Mode	Manual
Digital Slow Shutter	4x
Shutter Speed	1/30
AGC Gain	20
WDR/BLC Mode	Off
Day & Night	Day(Color)
Chroma	8
Sharpness	5
Mirror	Off
Flip	Off
Digital Noise Reduction	High
- Audio Information:** An unchecked section.
- Motion Detection Information:** A checked section containing a table:

Use	Use
Sensitivity	Middle
Dwell Time	5 sec
Relay	None
Duration	5 sec
- Sensor Information:** An unchecked section.

# WEBVIEWER\*

## Setup > System > Logs View

User can view detailed logs for system and/or events triggered and recorded in the camera.

1. To view, select the type of report you want to view: System, Event, or System & Event.
2. Select View.
3. The system will generate a report up to 140,000 bits of data.
  - › For events to record, make sure the camera is set to record when an event, like motion detection, is triggered. See page xxx for information on how to set motion detection for the MEGApix camera.
4. Select Export to save the log report to an excel file.

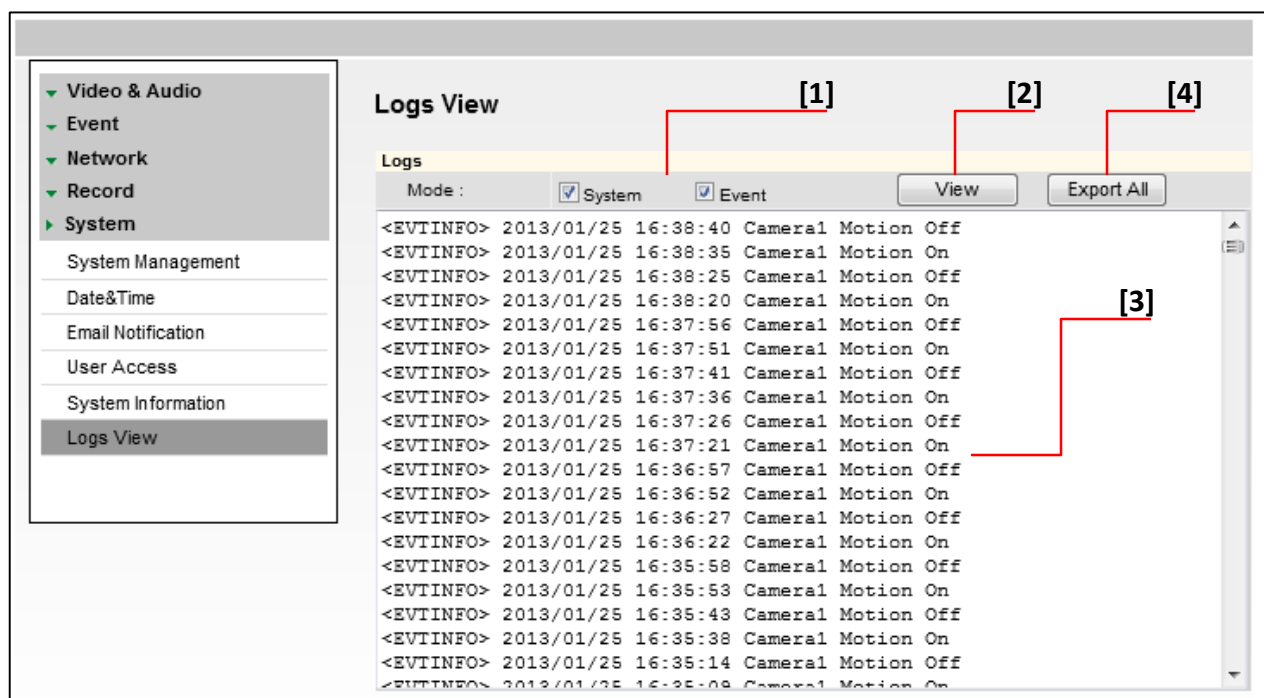



# SPECIFICATIONS\*

IMAGE	
Image Sensor	1/2.8" CMOS Sensor
Effective Pixels	1920 (H) x 1080 (V)
Minimum Scene Illumination	F2.0 (30IRE): 2.4 Lux [Color] F2.0 (30IRE): 0.5 Lux [B&W]
Focal Length	4.0mm , F1.8 [DWC-MB721M4TIR] 8.0mm , F2.0 [DWC-MB721M8TIR]
Lens Type	Fixed Lens
Digital Zoom	12X
IR Distance	50ft Range IR
OPERATIONAL	
Brightness	0~20
Shutter Mode	Auto/ Manual
Digital Slow Shutter	Off/ Up to x8
DNR (Digital Noise Reduction)	Off/ Low/ Middle/ High
Auto Gain Control	Max 41dB
BLC (Back Light Compensation)	Off/ On
WDR (Wide Dynamic Range)	Off/ Low/ Middle/ High
Day and Night	Auto/ Day (Color)/ Night (B/W)
Alarm Notifications	Notifications via E-mail
Privacy Zone	Off/ On (16 Programmable Zones)
Motion Detection: Sensitivity	Low/ Middle/ High
Memory Slot	24 hours recording to Micro SDHC Card (4GB-32GB) for emergency backup only. *Card not included
Recording Schedule Setup	Continuous/ Motion/ Sensor/ Pre- & Post- Alarm
Chroma (Hue & Saturation Settings)	0~20
Sharpness	0~10
Mirror & Flip	Off/ On

# SPECIFICATIONS\*

## NETWORK

LAN	802.3 Compliance 10/100 LAN
Video Compression Type	H.264, MPEG4, MJPEG (Super Fine ~ Low)
Resolution	1920X1080 (16:9) ~ 320X240 (4:3)
Frame Rate	Up to 30fps at All Resolutions
Stream Capability	Dual-Stream at Different Rates and Resolutions
IP	IPv4, IPv6
Protocol	TCP/IP, HTTP, DHCP, PPPoE, ICMP, ARP, RARP, RTSP, NTP, UDP, Multicast
Maximum User Access	5 Users
Memory Slot	Local SDHC Card Backup- 24 hours recording to Micro SDHC Card (4GB-32GB)
ONVIF Conformance	Yes, Profile S
Web Viewer	Supported OS: Windows XP, Windows Vista, Windows 7, MAC OS Supported Browser: Internet Explorer, Google Chrome, Mozilla Firefox, Safari
Video Management Software	DW Spectrum

## ENVIRONMENTAL

Operating Temperature	-10°C ~ 50°C (14°F ~ 122°F)
Operating Humidity	Less than 90% (Non-Condensing)
IP Rating	IP66 Certified (Protects against dust and high pressure water)
Other Specifications	CE, FCC, RoHS

## Electrical

Power Requirement	DV12V, PoE [IEEE802.3af, Class 2]
Power Consumption	LED Off: 3.5W, 300mA LED On: 5W, 430mA (Max 500mA)

## Mechanical

Housing Material	Aluminum Die-Casting
Dimensions	161.7 x 67.5mm (6.36 x 2.66in)
Weight	0.93 lbs

## TROUBLESHOOTING

Before sending your camera for repair, check the following or contact your technical specialist.

### **I can't find my MEGApix camera on the IP Finder software.**

- Is the PoE cable connected properly?  
Make sure cable is tightly connected at both ends. It should make a “click” sound when connected properly.  
Make sure cable is intact and there are no cuts or exposed wires.
- If Yes, are the camera's LED lights turned on and blinking?  
The camera's LED lights indicate that the camera is powered on. Blinking LED lights indicate that the camera has finished booting up and is transmitting data.
- If Yes, is the internet working properly?  
Make sure you can connect to the internet with other devices on the network (ex. Your Computer). Your internet could be temporarily down.
- If Yes, if using a power adaptor, does it meet camera's power requirements?  
Power Requirements: DC12V (5.16W, 430mA), PoE Ports (Class 2, less than 7W)
- If Yes, if using PoE Switch, is it connected to a proper internet outlet and operating properly?  
Make sure the PoE Switch is connected to a router/modem and the ports that have devices connected to them have a green LED on.
- If Yes, is the computer on the same network as the MEGApix camera?  
Camera and computer should be connected to the same router. Contact your network administrator if you have more than one network available.
- If Yes, try pinging the IP camera's default IP address 192.168.1.123  
From your desktop, go to Start > Programs > Accessories > Command Prompt. Type “ping 192.168.1.123” and press Enter. If you get the message “Request timed out,” camera is not connected. Camera is connected if you get data.
- If Yes, try connecting the camera to a different port in the PoE Switch.  
That specific Switch Port may be damaged or currently not working properly.
- If Yes, try resetting the camera to default settings.  
Press the 2 buttons in the back together and hold for 5 seconds. The camera will return to factory default with default IP address 192.168.1.123. If your network supports DHCP, the camera will be found using the IP Finder software with an IP address that matches your network's requirements.

## TROUBLESHOOTING

Before sending your camera for repair, check the following or contact your technical specialist.

### **I can't connect to my MEGApix camera through the Web Browser**

- Are the camera's LEDs on and blinking?  
The camera's LED indicates the camera is On. If the LED blinks, the camera has finished booting up and is transmitting data.
- If Yes, is the internet working properly?  
Make sure you connect to the internet with other devices on the network (ex. Your Computer). Your internet could be temporarily down.
- If Yes, is the computer on the same network as the IP camera?  
Camera and computer should be connected on the same router. Contact your network administrator if you have more than one network available.
- If Yes, try pinging the MEGApix camera's IP address as it appears on the IP finder.  
From your desktop, go to Start > Programs > Accessories > Command Prompt. Type "ping" followed by the camera's IP address; then, press Enter. If you get the message "Request timed out," camera is not connected. If you get data back, that means the camera is connected.
- If Yes, try connecting the camera, to a different port in the PoE Switch.  
That specific Switch Port may be damaged or currently not operating properly.
- If Yes, check your security settings on your internet browser.  
Try adding the camera's IP address to the trusted sites list in your Internet Options. \*Setup may vary depending on the browser you use.

## TROUBLESHOOTING

Before sending your camera for repair, check the following or contact your technical specialist.

### **I can't see the live video of my MEGApix camera.**

- Are you trying to view the camera's video from an Internet Explorer browser?  
Make sure you have the minimum PC requirements to view the MPA20M camera. \*See below for more information.
- If Yes, did you install ActiveX files?  
When you connect to your MEGApix camera for the first time, your browser will ask you to install ActiveX. Make sure your Web Browser's security settings do not block pop-up windows and allows ActiveX files to be installed and used. \*Setup may vary depending on the browser you use.
- If Yes, make sure nothing is blocking the MPA20M camera's lens.
- Are you trying to view the camera's video from a different browser than Internet Explorer (ex. Google Chrome, Mozilla Firefox, MAC Safari)?
- If Yes, at least one of the streams of the camera must have Codec set to MJPEG.  
Go to the camera's setup menu. Select Stream Settings. Select one of the streams and change its codec to MJPEG. Click Save and Reload to save changes. Go back to live screen and at the bottom of the screen, select the stream you have set to MJPEG. Live video will start streaming to your web browser.

### **Web Viewer Specifications**

#### *Minimum Requirements for PC*

<b>CPU</b>	Intel P4 2.0GHz Dual Core
<b>RAM</b>	More than 1GB
<b>HDD</b>	200 GB Required for Saving Clip Image
<b>OS</b>	Microsoft Windows XP or Higher
<b>Resolution</b>	Higher than 1024X768

## TROUBLESHOOTING

Before sending your camera for repair, check the following or contact your technical specialist.

### Setting the IP Address for your PC

Dynamic Host Configuration Protocol (DHCP) is the default setting for the camera.

If the MEGApix camera is connected to a DHCP network and the camera's IP Configuration Mode is set to DHCP, the server will automatically assign an IP address to the camera. If the camera is using DHCP, the default IP address will be 192.168.1.123, and the default subnet mask will be 255.255.255.0.

The MEGApix camera can also connect to the web viewer using a static IP address. This will allow you to set your own IP address manually.

Setup the Network Protocol on your PC.

1. Go to Network icon on your PC.
2. Right-click and select Properties.
3. Double-click Local Area Connection.
4. Click Properties.
5. Double-click Internet Protocol Version 4 (TCP/IPv4).
6. Select Obtain an IP address automatically to set the computer to a dynamic IP address, or select Use the following IP address to set the computer to a static IP address.
7. If the option Use the following IP address has been selected, setup the IP address as 192.168.1.XXX. The last three digits should be a number between 1 and 254.

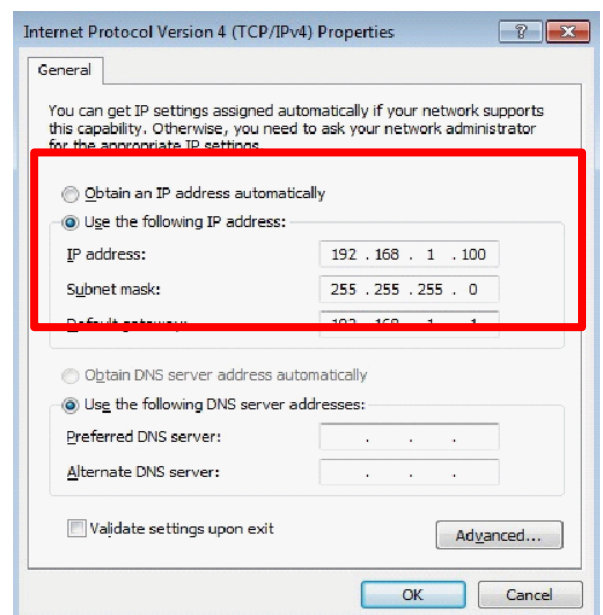
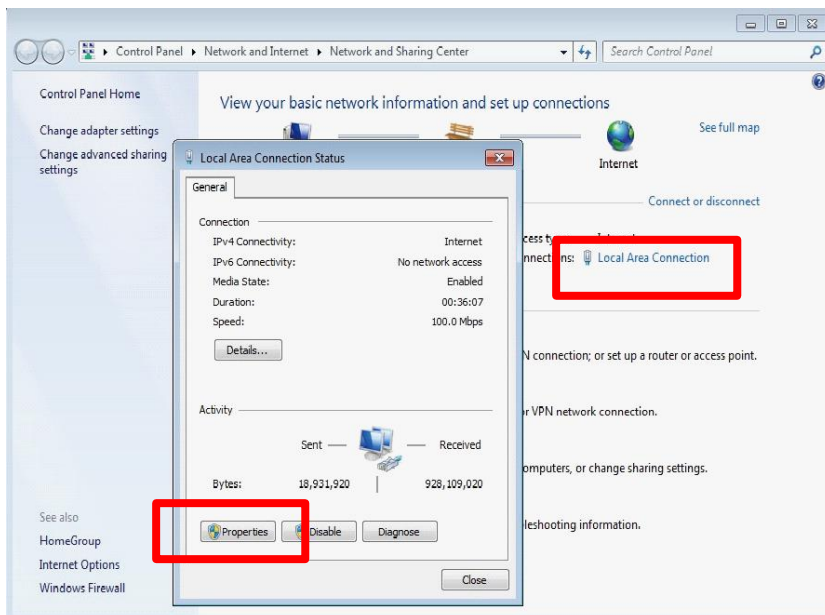

## WARRANTY INFORMATION\*

**Digital Watchdog** (referred to as “the Warrantor”) warrants the Camera against defects in materials or workmanships as follows:

**Labor:** For the initial two (2) years from the date of original purchase if the camera is determined to be defective, the Warrantor will repair or replace the unit with new or refurbished product at its option, at no charge.

**Parts:** In addition, the Warrantor will supply replacement parts for the initial two (2) years.

To obtain warranty or out of warranty service, please contact a technical support representative at 1-866-446-3595 Monday through Friday from 9:00AM to 8:00PM EST.

A purchase receipt or other proof of the date of the original purchase is required before warranty service is rendered. This warranty only covers failures due to defects in materials and workmanship which arise during normal use. This warranty does not cover damages which occurs in shipment or failures which are caused by products not supplied by the Warrantor or failures which result from accident, misuse, abuse, neglect, mishandling, misapplication, alteration, modification, faulty installation, set-up adjustments, improper antenna, inadequate signal pickup, maladjustments of consumer controls, improper operation, power line surge, improper voltage supply, lightning damage, rental use of the product or service by anyone other than an authorized repair facility or damage that is attributable to acts of God.

## LIMITS & EXCLUSIONS\*

There are no express warranties except as listed above. The Warrantor will not be liable for incidental or consequential damages (including, without limitation, damage to recording media) resulting from the use of these products, or arising out of any breach of the warranty. All express and implied warranties, including the warranties of merchantability and fitness for particular purpose, are limited to the applicable warranty period set forth above.

Some states do not allow the exclusion or limitation of incidental or consequential damages or limitations on how long an implied warranty lasts, so the above exclusions or limitations may not apply to you. This warranty gives you specific legal rights, and you may also have other rights from vary from state to state.

If the problem is not handled to your satisfaction, then write to the following address:

Digital Watchdog, Inc.  
ATTN: RMA Department  
5436 W Crenshaw St  
Tampa, FL 33634

Service calls which do not involve defective materials or workmanship as determined by the Warrantor, in its sole discretion, are not covered. Cost of such service calls are the responsibility of the purchaser.

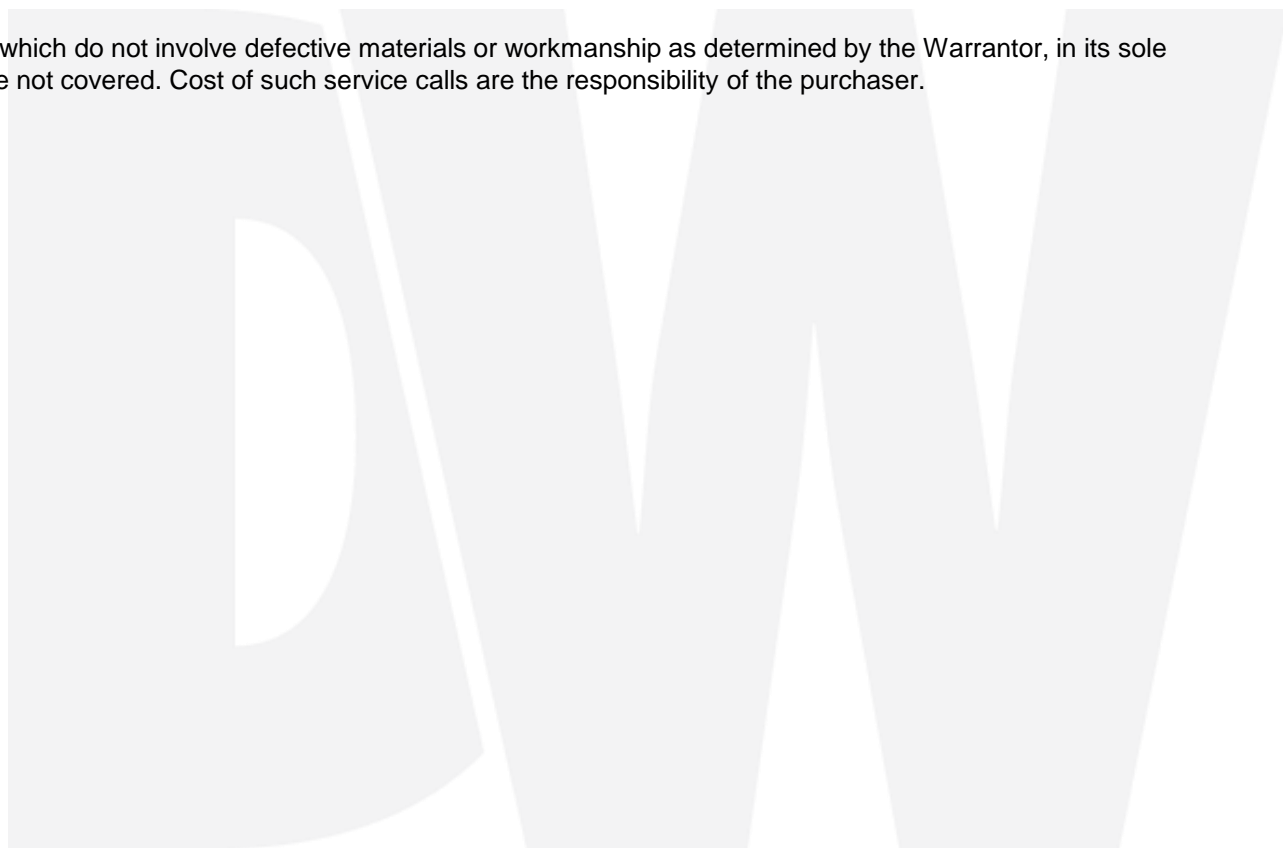



# MEMO\*

**MEMO\***

# MEMO\*



**Headquarters Office: 5436 W Crenshaw St, Tampa, FL 33634**  
**Sales Office: 16220 Bloomfield Ave., Cerritos, California, USA 90703**  
**PH: 866-446-3595 | FAX: 813-888-9262**  
**[www.Digital-Watchdog.com](http://www.Digital-Watchdog.com)**  
**[technicalsupport@dwcc.tv](mailto:technicalsupport@dwcc.tv)**  
**Technical Support PH:**  
**USA & Canada 1+ (866) 446-3595**  
**International 1+ (813) 888-9555**  
**French Canadian 1+ (514) 360-1309**  
**Technical Support Hours: Monday-Friday**  
**9:00am to 8:00pm Eastern Standard Time**