

MEGApix[®] Panoramic 2.1MP 180° Camera DWC-PV2M4T



User's Manual Ver. 1.0 / 2015.04.21

Before installing and using the camera, please read this manual carefully.
Be sure to keep it handy for future reference.

Safety Information



CAUTION

RISK OF ELECTRIC SHOCK.
DO NOT OPEN.



CAUTION:

TO REDUCE THE RISK OF ELECTRIC SHOCK, DO NOT REMOVE COVER (OR BACK) NO USER SERVICEABLE PARTS INSIDE. REFER SERVICING TO QUALIFIED SERVICE PERSONNEL.



Warning

This symbol indicates that dangerous voltage consisting a risk of electric shock is present within this unit.



Precaution

This exclamation point symbol is intended to alert the user to the presence of important operating and maintenance (servicing) instructions in the literature accompanying the appliance.

WARNING

To prevent damage which may result in fire or electric shock hazard, do not expose this appliance to rain or moisture.

WARNING

1. Be sure to use only the standard adapter that is specified in the specification sheet. Using any other adapter could cause fire, electrical shock, or damage to the product.
2. Incorrectly connecting the power supply or replacing battery may cause explosion, fire, electric shock, or damage to the product.
3. Do not connect multiple cameras to a single adapter. Exceeding the capacity may cause excessive heat generation or fire.
4. Securely plug the power cord into the power receptacle. Insecure connection may cause fire.
5. When installing the camera, fasten it securely and firmly. A falling camera may cause personal injury.
6. Do not place conductive objects (e.g. screw drivers, coins, metal items, etc.) or containers filled with water on top of the camera. Doing so may cause personal injury due to fire, electric shock, or falling objects.
7. Do not install the unit in humid, dusty, or sooty locations. Doing so may cause fire or electric shock.
8. If any unusual smells or smoke come from the unit, stop using the product. Immediately disconnect the power source and contact the service center. Continued use in such a condition may cause fire or electric shock.
9. If this product fails to operate normally, contact the nearest service center. Never disassemble or modify this product in any way.
10. When cleaning, do not spray water directly onto parts of the product. Doing so may cause fire or electric shock.

Precaution

Operating

- Before using, make sure power supply and all other parts are properly connected.
- While operating, if any abnormal condition or malfunction is observed, stop using the camera immediately and contact your dealer.

Handling

- Do not disassemble or tamper with parts inside the camera.
- Do not drop the camera or subject it to shock or vibration as this can damage the camera.
- Clean the clear dome cover with extra care. Scratches and dust can ruin the quality of the camera image.

Installation and Storage

- Do not install the camera in areas of extreme temperature, exceeding the allowed range.
- Avoid installing in humid or dusty environments.
- Avoid installing in places where radiation is present.
- Avoid installing in places where there are strong magnetic fields and electric signals.
- Avoid installing in places where the camera would be subject to strong vibrations.
- Never expose the camera to rain or water.

Important Safety Instructions

- 1. Read these instructions.** - All these safety and operating instructions should be read before the product is installed or operated.
- 2. Keep these instructions.** - The safety, operating and use instructions should be retained for future reference.
- 3. Heed all warnings.** - All warnings on the product and in the operating instructions should be adhered to.
- 4. Follow all instructions.** - All operating and use instructions should be followed.
- 5. Do not use this device near water.** - For example: near a bath tub, wash bowl, kitchen sink, laundry tub, in a wet basement; near a swimming pool; etc.
- 6. Clean only with dry cloth.** - Unplug this product from the wall outlet before cleaning. Do not use liquid cleaners.
- 7. Do not block any ventilation openings. Install in accordance with the manufacturer's instructions.** - Slots and openings in the cabinet are provided for ventilation, to ensure reliable operation of the product, and to protect it from over-heating. The openings should never be blocked by placing the product on bed, sofa, rug or other similar surface. This product should not be placed in a built-in installation such as a bookcase or rack unless proper ventilation is provided and the manufacturer's instructions have been adhered to.
- 8. Do not install near any heat sources such as radiators, heat registers, or other apparatus (including amplifiers) that produce heat.**
- 9. Do not defeat the safety purpose of the polarized or grounding-type plug.** A polarized plug has two blades with one wider than the other. A grounding type plug has two blades and a third grounding prong. The wide blade or the third prong are provided for your safety. If the provided plug does not fit into your outlet, consult an electrician for replacement of the obsolete outlet.
- 10. Protect the power cord from being walked on or pinched particularly at plugs, convenience receptacles, and the point where they exit from the apparatus.**
- 11. Only use attachments/accessories specified by the manufacturer.**
- 12. Use only with cart, stand, tripod, bracket, or table specified by the manufacturer, or sold with the apparatus. When a cart is used, use caution when moving the cart/apparatus combination to avoid injury from tip-over.**
- 13. Unplug this apparatus during lightning storms or when unused for long periods of time.**
- 14. Refer all servicing to qualified service personnel.** Servicing is required when the apparatus has been damaged in any way, such as power supply cord or plug is damaged, liquid has been spilled or objects have fallen into the apparatus, the apparatus has been exposed to rain or moisture, does not operate normally, or has been dropped.





Disposal of Old Appliances

1. When this crossed-out wheel bin symbol is attached to a product it means the product is covered by the European Directive 2002/96/EC.
2. All electrical and electronic products should be disposed of separately from the municipal waste stream in accordance to laws designated by the government or the local authorities.
3. The correct disposal of your old appliance will help prevent potential negative consequences for the environment and human health.
4. For more detailed information about disposal of your old appliance, please contact your city office, waste disposal service or the shop where you purchased the product.



This equipment has been tested and found to comply with the limits for a Class A digital device, pursuant to part 15 of the FCC Rules. These limits are designed to provide reasonable protection against harmful interference when the equipment is operated in a commercial environment. This equipment generates, uses, and can radiate radio frequency energy and, if not installed and used in accordance with the instruction manual, may cause harmful interference to radio communications. Operation of this equipment in a residential area is likely to cause harmful interference in which case the user will be required to correct the interference at his own expense.

Introduction - Product & Accessories

⊠ Please check that all the following accessories are included in the package.

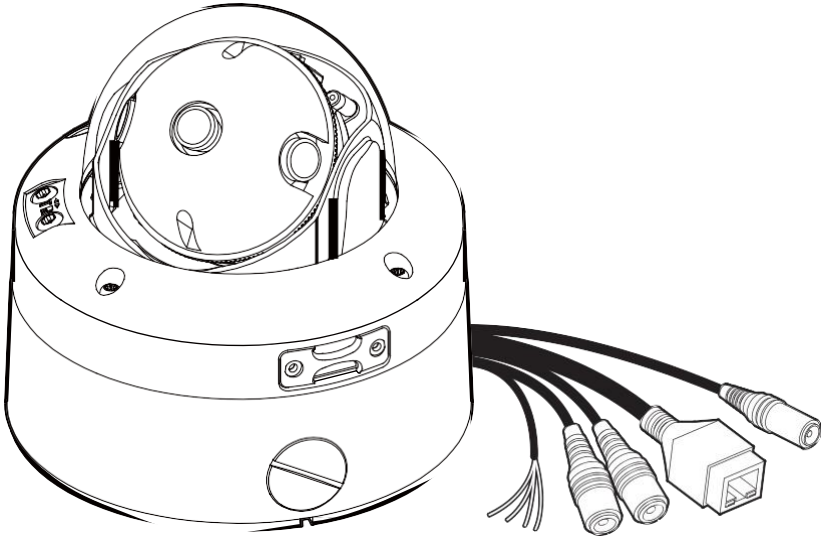

Camera

Cables

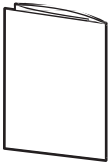

Quick Manual

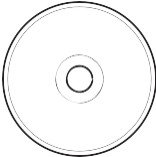

Manual CD

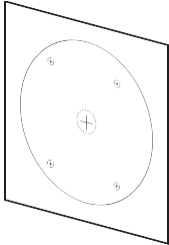

Template Sheet



Test Monitor Cable

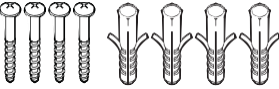

Screw & Plastic Anchor-4pcs

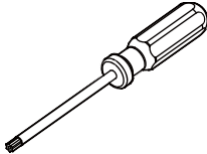

T-Wrench
(For Lens Tilting and
Rotation Control)

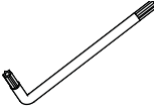

Torx Wrench
(For SD Card Cap)

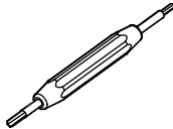

Six angles Wrench
(For Hard Lock Set Screw)

Introduction - Product & Accessories

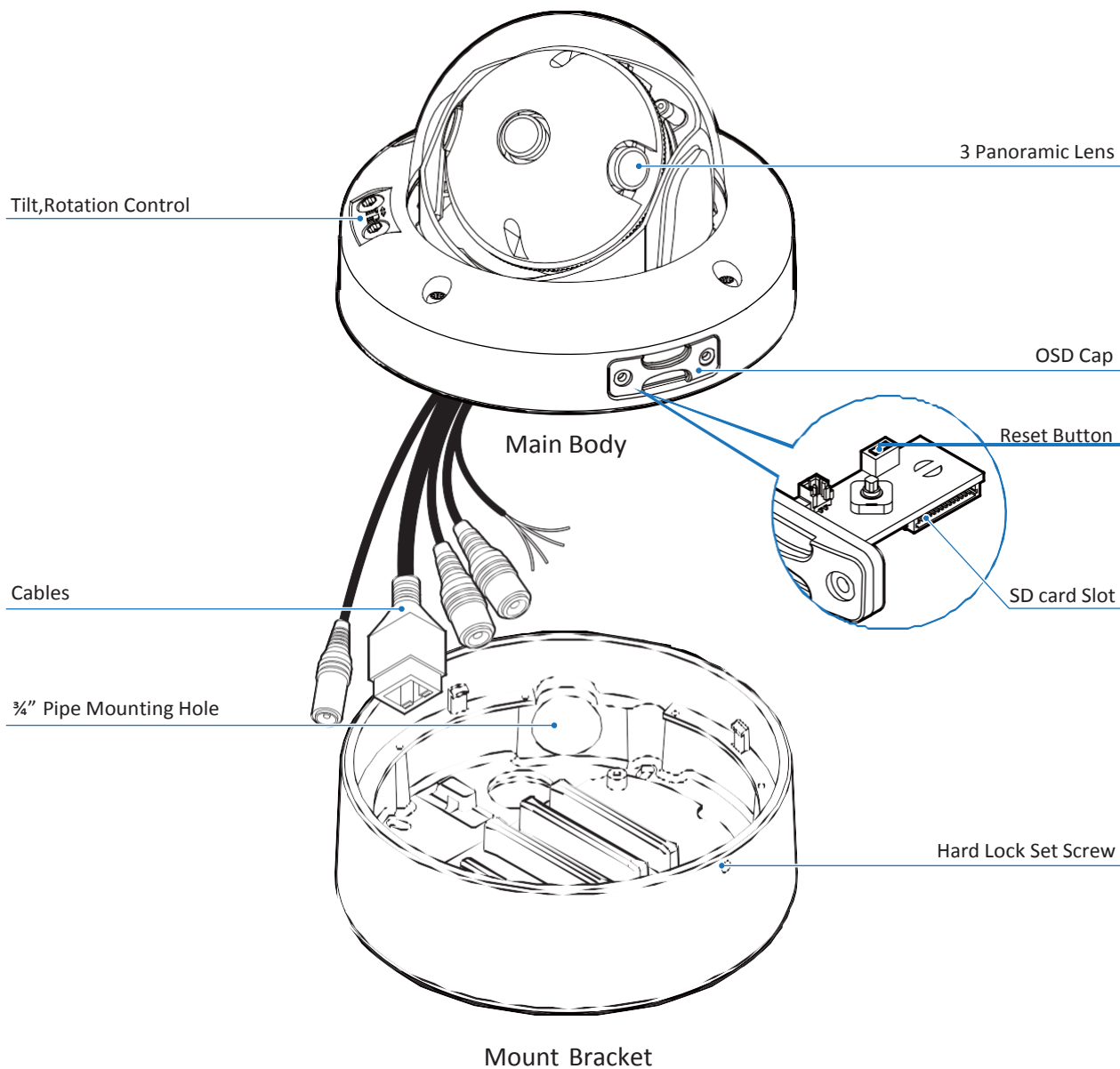

Installation - Disassemble the Camera

Before installing your camera, you have to read the following cautions.

1. You have to check whether the location can bear five times of the weight of your camera.
2. Don't let the cable to be caught in improper place or the electric line cover to be damaged. Otherwise it may cause a breakdown or fire.
3. When installing your camera, don't allow any person to approach the installation site. If you have any valuable things under the place, move them away.

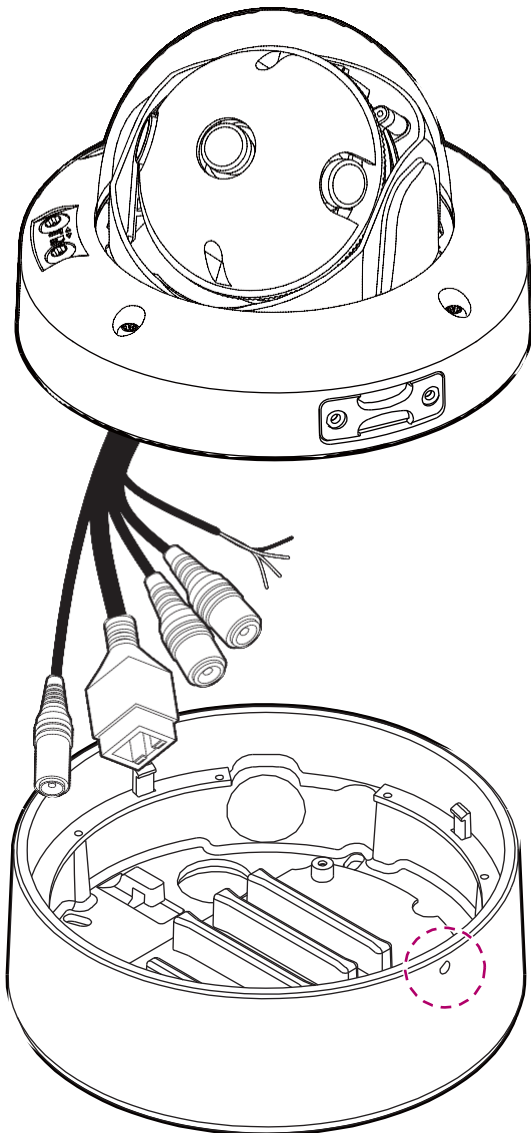

1 Disassemble the camera

Loosen a small hard lock set screw on the Mount Bracket using a small six angles wrench to disassemble the camera from a Mount Bracket to for installation.

⚠ Warning:

Never Open the Dome.

Supplier will not take any responsibility on any defecion from an arbitrary disassembly.

Installation - Mounting the Camera

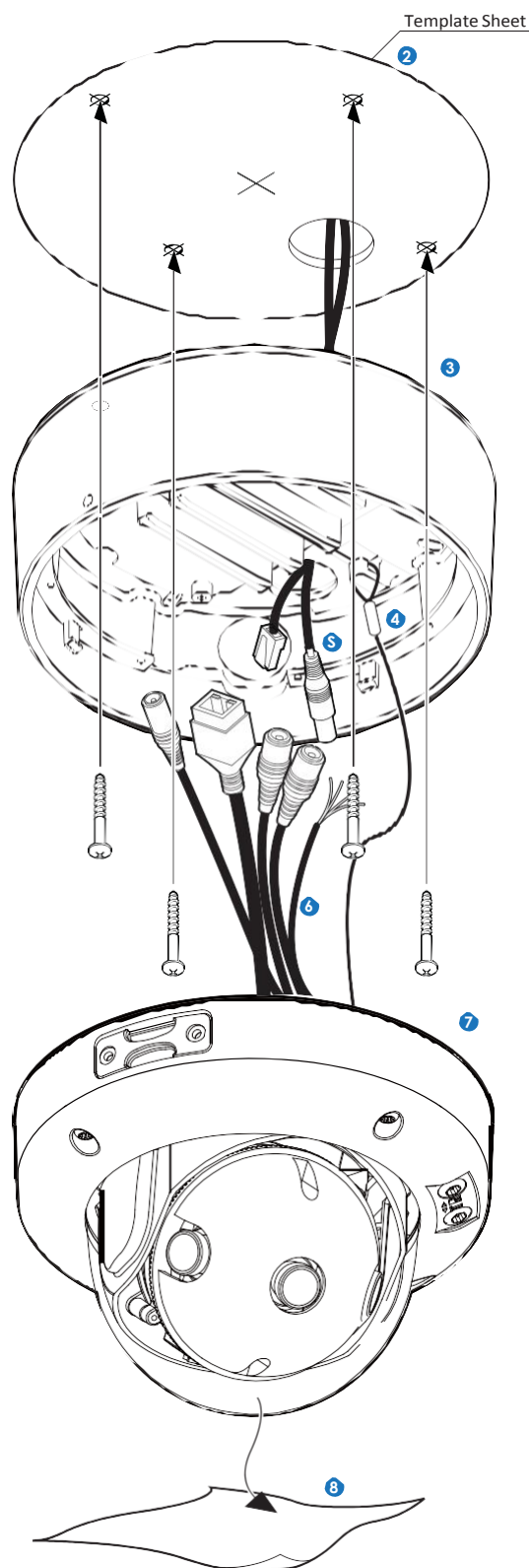

- 1 Disassemble the camera, See the section 'Disassemble the camera' for details.
- 2 Using the template sheet, make the cabling holes on the wall/ceiling.
- 3 Fix the Mount bracket on the wall/ceiling by screw provided.
- 4 Hook the Main body to Mount bracket with safetywire.
- 5 Bring the cables into the Mount bracket through the hole.

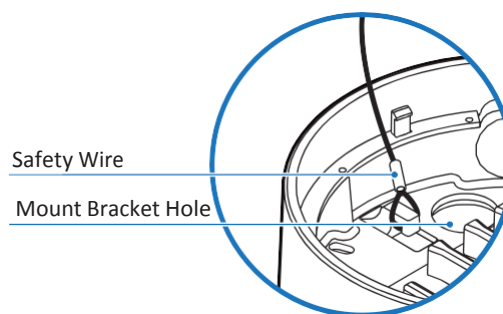

- 6 Connect the cables respectively. See the section 'Cabling' for details.
- 7 After connecting the cables, main body to be assembled into the Mount bracket.
- 8 Detach the protection film from the Dome Cover.
- 9 Adjust the panning angle of the camera and tighten the hard lock set screw on the camera's Dome. See next page for more information.

Installation - Adjusting the Camera's Pan and Tilt

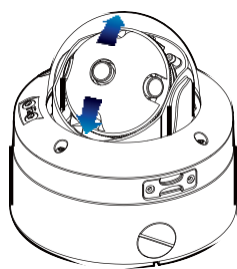
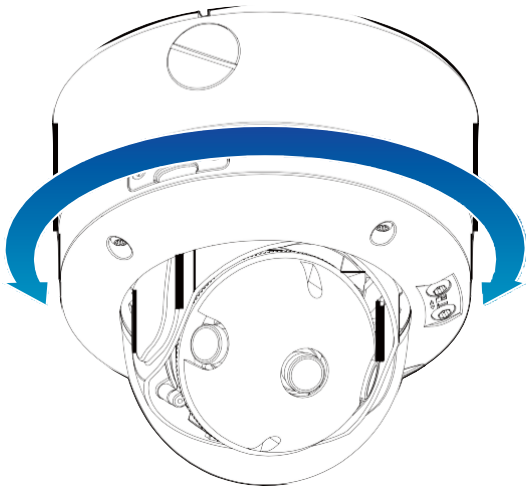

Lens Tilt

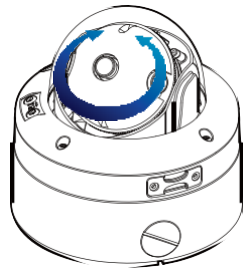

Lens Rotation

- 6 Pull wires through and make all necessary connections. See 'Cabling' section for more information.
- 7 Connect the camera's main body to the mounting bracket.
- 8 Adjust the panning angle of the camera and tighten hard lock set screw to fix the camera. Use the included six-angle wrench included with the camera to tighten the screw and secure the camera module to the mounting bracket.
- 9 Adjust the lens' angle by adjusting the controlling screws on the main body. Use the included T-wrench. The screws located at the base of the camera dome control the lens' tilt up and down and its rotation.

Tilting Range	Rotating Range
0° ~ 90°	0° ~ 360°

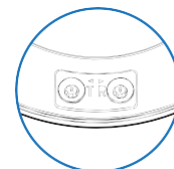

- 10 When the installation is complete, detach the protective film from the camera's dome.

⊠Warning:

The camera's lens module can rotate 360° at each direction. Rotating the lens constantly to the same direction may harm the internal rotation mechanism and cause the lens' rotation harness to snap.

Installation - Inserting / Removing the SD Memory Card

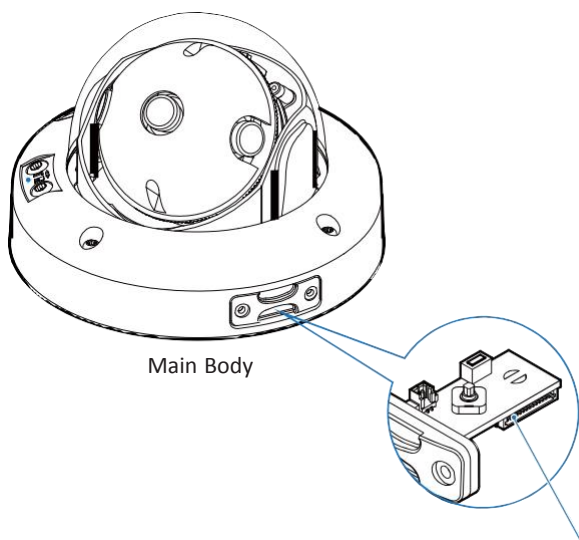

- 1 To open the SD card slot, use the included Torx wrench.
- 2 Insert the SD card in the arrow direction.

⊗ Do not insert the SD memory card while it's upside down by force. Otherwise, it may damage the SD memory card.

- 3 Removing an SD Memory Card Gently press down on the Remove the SD Memory Card gently by pressing down on the exposed end of the memory card as shown in the diagram to eject the memory card from the slot.

⊗ Pressing too hard on the SD memory card may cause the card to shoot out uncontrollably from the slot when released.

⊗ If you have saved data in the SD memory card, removing the SD memory card prior to setting record to OFF will cause damage to the data stored in the card.

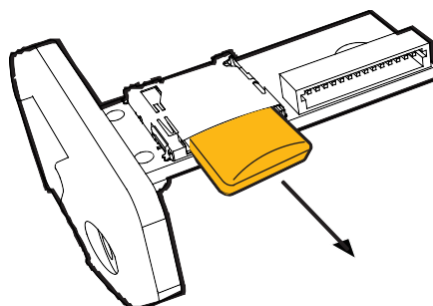
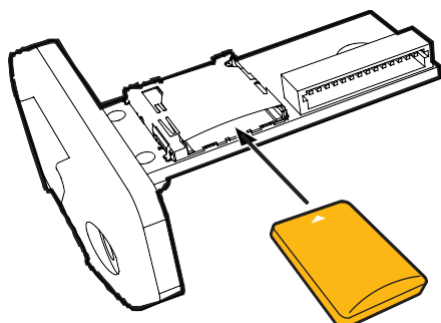

The memory card is an external data storage device that has been developed to offer an entirely new way to record and share video, audio, and text data using digital devices.

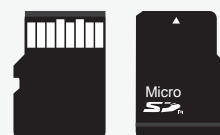

- ⊗ Recommended SD Card Specification (**Not Included**)
- Type: Micro SD (SDHC)
 - Manufacturer: Transcend, Kingston, Toshiba, SanDisk
 - Capacity: 4~16G
 - Class: over Class 6

Installation - Cabling

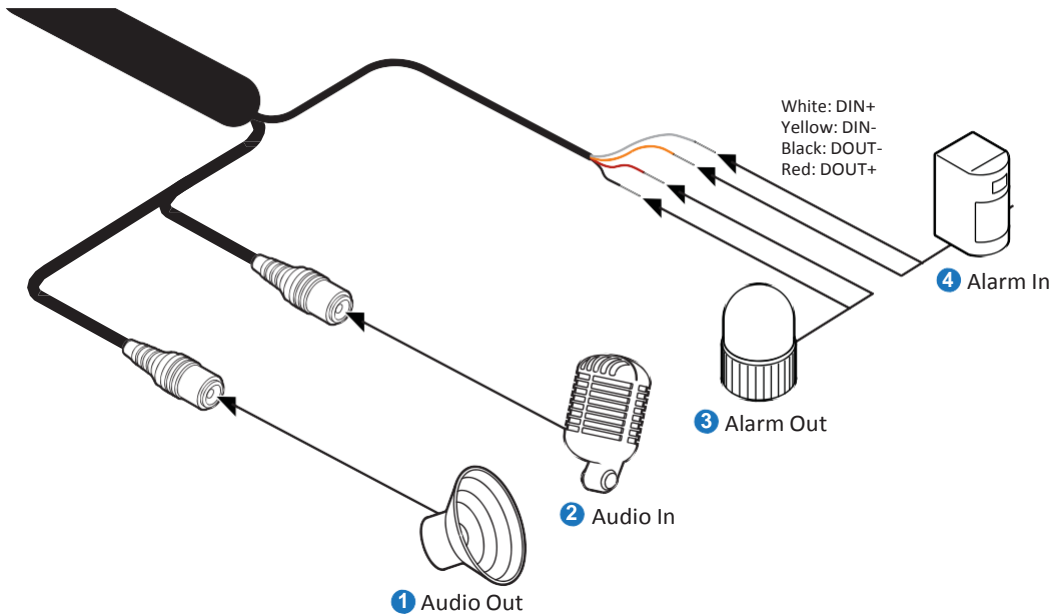

① Audio In

Connect an 'Audio In' device such as a microphone to the camera's input cable and GND pin of the cable slot. Audio input device is activated and configured from the camera's web-viewer.

② Audio Out

Connect an 'Audio Out' device such as a speaker to the camera's output cable and GND pin of the cable slot. Audio volume is controlled from the camera's the web-viewer.

③ Alarm Out

Connects to alarm lights, siren or lamps. Sensor types are normal open and normal close. Connect an alarm output device to the camera's alarm out+ and alarm out- cables in the cable slot.

④ Alarm In

Connect a sensor/alarm input device to the camera's alarm in+ and alarm in- cables in the cable slot.

Installation - Cabling

Two Options

Use a PoE-enabled switch to connect data and power through a single cable and begin viewing and recording images instantly. A non-PoE switch will require an adaptor for power transmission.

1. Using a PoE-Enabled Switch

The Camera is PoE-compliant, allowing transmission of power and data via a single Ethernet cable. PoE eliminates the need for the different cables used to power, record, or control the camera. Follow the illustration below to connect the camera to a PoE-enabled switch using an Ethernet cable.

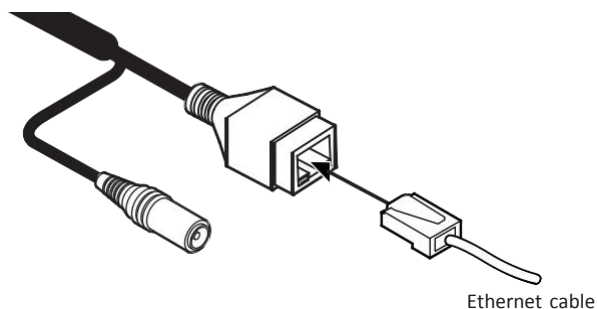

2. Using a Non-PoE Switch

If a PoE-enabled switch is not used, use a power adaptor for power transmission and non-PoE switch for data transmission. Follow the illustrations below to connect the camera without a PoE-enabled Switch.

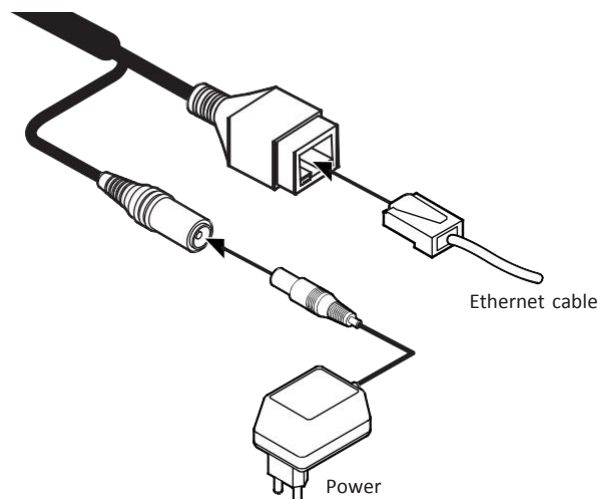

Network Setup - DW Desktop Tool™

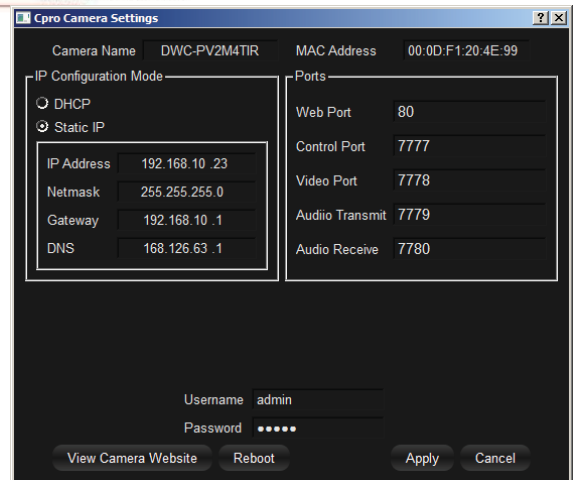
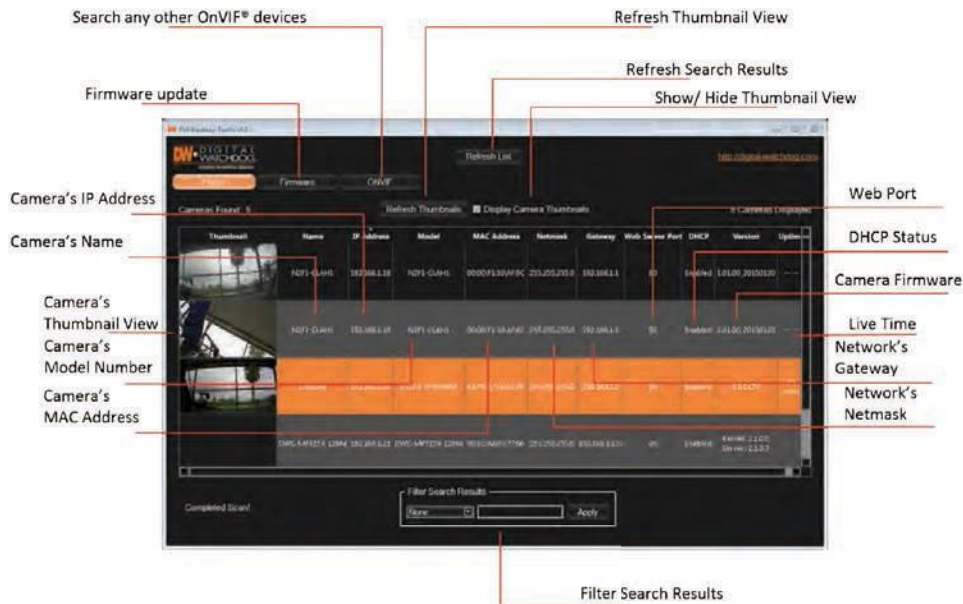

- 1 Run the CD included with the camera and click on the DW Desktop Tool™ file.
- 2 The software will scan your network for all supported cameras and display the results in the table. Allow up to 5 seconds for the IP Installer to find the camera on the network.
- 3 You can press the 'Refresh List' to search the network again, or filter the search results by entering a value in the filter box at the bottom of the page.
- 4 Check the box next to 'Display Camera Thumbnail' to view a JPEG image of the camera's view next to the camera name on supported models.
- 5 Select a camera from the list by double-clicking on it. The camera's network information will appear. If necessary, you can adjust the camera's network type.

i Select DHCP if the internet service is dynamic IP. This will allow the camera to receive its IP address from the DHCP server.

i Select STATIC to manually enter the camera's IP address, subnet mask, Gateway and DNS information.

i Contact your network administrator for more information.

- 6 The camera's default network information is:

i Default TCP/IP information

- IP: 192.168.1.80
- Subnet Mask: 255.255.255.0
- Gateway: 192.168.1.1
- DNS : 168.126.63.1

- 7 To view the camera's web client, click on 'View Camera Website'.

i A 'Port Forwarding' has to be set in your network's router for external access to the camera.

- 8 To save the changes made to the camera's settings, input ID and PW of the camera for authentication.

- 9 If the camera needs to be rebooted after the settings were changed, press the 'Reboot' button. The camera will power cycle and will appear back in the search results once the reboot is complete.

i Default ID / PW : admin / admin

- 10 Click 'Save' to save changed values.

- 11 To update the camera's firmware from the DW Desktop Tool™, click on the firmware tab, upload the firmware file and select the cameras to update. You can update multiple cameras at the same time.

Network Setup - Quick Start of Network Connection

Please follow the steps below to complete the initial setup of the network function.

- ❗ Do not power on the IP camera until instructed.
- ❗ Temporarily disable any proxy servers configured in Internet Explorer.
- ❗ If the IP camera is connected directly to a modem, power down and reset the modem. Leave the modem powered down until configurations are finalized with the IP camera and the IP camera has been correctly connected to the modem.

1. In order to communicate with the IP camera, access your PC/laptop for configuration.
Keep a record of your PC's TCP/IP properties (IP address, subnet mask, gateway, DNS, etc.)

Current TCP/IP Settings	
IP Address	
Subnet Mask	
Default Gateway	
Primary DNS Server	
Secondary DNS Server (Optional)	

- ❗ If your PC obtains its IP address automatically, there is no need to record any information.

2. Change the IP address of the host PC to 192.168.1.11 and subnet mask to 255.255.255.0 (leave all other entries blank).
3. Connect the IP camera directly to your PC's Ethernet port via a crossover cable. (It does not matter what end is used for the PC).
4. Power on the IP camera using a power adapter.
5. After 1 minute, verify a flashing ACTIVE indicator and a flashing or solid LINK indicator. After the corresponding indicator lights are properly displayed, open Internet Explorer.
6. Type - <http://192.168.1.80> (the default IP of the IP camera) into your address bar.
7. Default ID/Password to access IP Camera are both the word: **admin**.
8. Locate the TCP/IP configuration under Setup> Network> TCP/IP.
9. Select STATIC under 'Network Type'. Select Dynamic only if you are connecting the IP camera directly to your cable/DSL/Broadband modem and your Internet Service Provider is supplying a dynamic address.

- ❗ If you have a network with other devices (such as PC/laptop, etc.) or a router, NEVER select Dynamic.

10. Configure the IP camera's TCP/IP settings as you normally do any other PCs on your network by providing a proper IP address, subnet mask, default gateway, and DNS server.

- ❗ If this is a stand-alone unit with a direct connection to cable/DSL/Broadband modem, input the addresses from your ISP. If you have received no IP address from your ISP, select Dynamic and choose the proper settings.

11. The IP Camera utilizes five TCP ports - Web Port, Video Port, Control Server Port, and Audio ports. A Web Port utilizes Internet Explorer, a Video Server port supports the streaming video, a Control Server Port transmits control commands to the camera and Audio Ports transmit and receive Audio data. If the IP camera is directly attached to a cable/DSL/Broadband modem or it has been assigned a static IP from your ISP, do not change the default port settings. If you are installing the IP camera on a network, you must define a Web Port other than 80 as some ISP block port 80. The other ports can remain unchanged.

12. If the IP camera is connected to a network utilizing a router, you must have Port Forwarding configured on your personal router to forward all ports to the IP address you have assigned the IP Camera. (See your Network Administrator for more information).

13. After configuring Port Forwarding on your router (if necessary), you may access your IP camera on your local network by opening Internet Explorer and typing the camera's IP address and Web Port.

- ❗ Example: <http://192.168.0.200:8888>

- ❗ If you leave your Web Port set to 80, you do not need to specify the port in the Address Bar to access to your IP Camera.

14. Access your IP Camera via the Internet :

If you use a static IP address assigned by your ISP

- 1) Open Internet Explorer.
- 2) Type the IP of the IP camera.
- 3) If you use a router, type the routers' static IP and the web port number of the IP Camera.

If you have a dynamic address provided by your ISP

- 1) Open Internet Explorer and visit the DDNS website.
- 2) Register the IP camera.
- 3) Reboot the IP camera.
- 4) Give the DDNS server up to 10 minutes to locate your IP camera's IP information.
- 5) Click the refresh button in Internet Explore.

Network Setup - Direct Connection to PC for Initial Setup

This section provides a guide on how to connect the IP camera to your PC/Laptop for initial setup.

Please follow the instructions in the order below. Do not supply power to the IP camera until instructed.

In order to access the IP camera's firmware you will need to connect the Video Server to a PC or Laptop directly via a network cable.

1. Before you begin, you must determine the current network/Internet (TCP/IP) settings on the PC or laptop. Write down your entries below for quick reference.

Current TCP/IP Settings	
IP Address	
Subnet Mask	
Default Gateway	
Primary DNS Server	
Secondary DNS Server (Option)	

- ❗ For information on how to determine your current settings, see Appendix A.
- ❗ If you are obtaining an IP Address automatically using DHCP Settings, there is no need to write down the information.

2. To make the IP camera communicate with your PC, change your PC's IP address and subnet mask.

- ❗ Change your PC's IP address to 192.168.1.11 and the subnet mask to 255.255.255.0
Leave all other entries (Default Gateway, DNS Servers, etc.) blank.
- ❗ For information on how to change your IP address and subnet mask, see Appendix B.

3. Attach the IP camera to your PC via a network cable. Plug-in either end of the network cable into the PC's network slot and the other end into your IP camera.
4. Power on the IP camera by plugging in a power supply.
5. Wait up to 1 minute after powering on the IP camera and verify that the ACTIVE indicator light is flashing, and the LINK indicator light is flickering or solid. If they are not, see FAQ.

6. You can now access the camera's viewer using Internet Explorer.

- ❗ Open Internet Explorer and type the IP address 192.168.1.80 (default IP of the IP camera) into the Address Bar of the web browser (as seen below). Press Enter.



- ❗ If a message box as below appears, choose 'Try Again!'. The message will vary depending on the operating system.



7. Once you connect to the camera successfully, the camera's login screen will appear.

- ❗ The 3 authorities are available:
Administrator, Operator and Viewer. The authority setup is available in the camera's Setup menu.
 - Viewer : Only monitoring is allowed.
 - Operator : Most of the functions are allowed except 'Setup'.
 - Administrator: All functions are allowed.

8. The default ID and Password for the camera are both 'admin'
9. At any time if you are prompted to download ActiveX controls, Click 'Yes' as all contents are safe.

- ❗ You will have to click 'Yes' twice to two individual prompts. This allows your video to be displayed in Internet Explorer.

Network Setup - DDNS Registration

If you have DYNAMIC IP service from your Internet Service Provider (ISP), you will not be able to tell the current IP address of the IP camera. To solve this problem, you may register to our DDNS service.

Check if you are using dynamic addressing for the camera. If so, register your IP Video Server on our DDNS website before you configure, setup, or install the IP Camera.

Even though your IP is not dynamic, you can register your camera to the DDNS server. This allows you to remember a simple URL address instead of complicated series of numbers like <http://201.23.4.76:8078>.

For more details, contact our Support Center.

- ⊠ To register IP camera to DDNS, the camera's 'Serial No.' is required. The 'Serial No.' can be found in section 6 'Setup - DDNS' menu.
- ⊠ To use a public DDNS such as 'dyndns' or 'no-ip', refer to the detail information on how to use the service. (Visit the web site: <http://www.dyndns.com> or <http://www.no-ip.com> for more information).

Network Setup - Guide to Network Environment

Please configure the IP camera at the installation site. Determine your network scenario in order to configure the IP camera with the proper TCP/IP settings. This tutorial will guide you through the process. Before configuring the IP camera, determine what settings need to be applied. Record those settings to be used to configure your IP camera for reference.

When configuring your IP camera, treat the IP camera as any other PC on your network. You will assign it several addresses and other TCP/IP properties to match your current network.

This step-by-step tutorial will teach what IP addresses and network configurations should be assigned based on the network scenario.

1. Before you begin, locate any information and settings received from your Internet Service Provider (ISP). You may need to refer to these IP addresses at a later time during the configuration.

Current TCP/IP Settings	
IP Address	
Subnet Mask	
Default Gateway	
Primary DNS Server	
Secondary DNS Server (Option)	

Static Dynamic

- i** If you were not given any IP addresses or the ISP was responsible for the setup and installation of your Internet connection, go to step 2.
- i** If you are not using a router on your network, your 'Current TCP/IP Settings' from the previous section and 'Assigned IP Addresses from My ISP' will be exactly the same.

2. You must determine whether the IP address is STATIC or DYNAMIC. At this moment, you are only concerned via the ISP. Did they provide you with a STATIC or DYNAMIC address? If you are unsure, contact your ISP.
3. Configure your IP camera's TCP/IP settings for network connectivity by selecting Setup from the camera's web viewer and selecting TCP/IP under the network settings.

4. If prompted for ID and Password, use 'admin' for both entries.
The default web port is 80. If port 80 is blocked by the ISP, a value between 1025 ~ 60000 should be used. If TCP port 80 is blocked, consult the ISP.
5. The following descriptions are several basic network scenarios. Determine which scenario describes your network. If your network does not match one of the scenarios below and you are unsure how to setup your IP camera, contact your network administrator and then call our Support Center.

Network Setup - Setup Case A, B

Case A: Dynamic IP + Personal Router [Most SOHO]

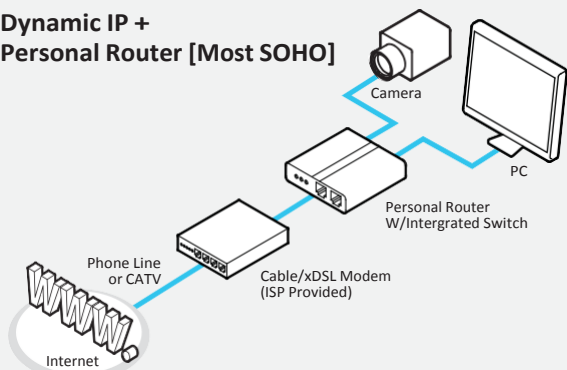

Case B: Static(Fixed) IP + Personal Router [Efficient]

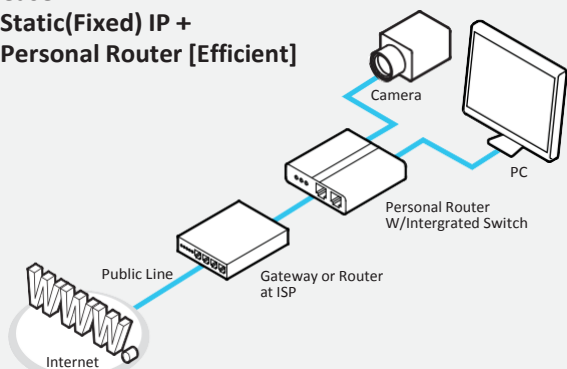

Configure your IP Camera's TCP/IP properties as follows:

1. Network Type : STATIC (even though you have Dynamic IP from your ISP, use STATIC on the IP Camera)

2. Internet Address : A private IP address such as 192.168.0.200 (Example)

- ❗ Assign an IP address to the IP Camera just as you do with PC.
- ❗ The IP address you assign must be unique to your network and match your network as well. For information on how to choose a unique IP and match your network, read the FAQ.
- ❗ The IP address you assign must be a private IP. For information on how to choose a private IP please, read the FAQ.

3. Subnet Mask : 255.255.255.0(Example)

- ❗ Use the same subnet mask as the one you noted under 'Current TCP/IP Settings'.

4. Default Gateway : 192.168.0.1 (Example)

- ❗ This is the IP address of your router. (private or LAN side)
- ❗ Use the same Default Gateway you noted under 'Current TCP/IP Settings'.

5. Preferred DNS Server : Use the 1st DNS Server from 'Assigned IP Address from My ISP'.

- ❗ If you did not receive any IP addresses from your ISP, contact the ISP and acquire the IP address of their DNS server.

6. DDNS Server : Use the DDNS server.

- ❗ This is the same site you will register later to accommodate dynamic IP from your ISP.

7. Web Port : 8888

- ❗ Do not use the default port 80 as this number may be blocked by your ISP.
- ❗ You may select any number between 1025 ~ 60000.

8. Control Port : 7777

- ❗ You may select any number between 1025 ~ 60000.

9. Video Port : 7778

- ❗ You may select any number between 1025 ~ 60000.

10. Audio Transmit Port : 7779

- ❗ You may select any number between 1025 ~ 60000.

11. Audio Receive Port : 7780

- ❗ You may select any number between 1025 ~ 60000.

Network Setup - Setup Case C, D

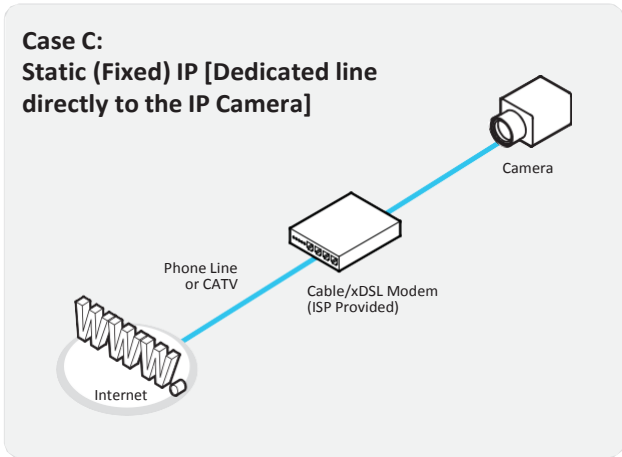

Configure your IP camera's TCP/IP properties:

- 1. Network Type :** STATIC
- 2. Internet Address :** A static IP address received from your ISP such as 24.107.88.125 (Example)

i Assign an IP address to the IP camera just as you do with PC.

- 3. Subnet Mask :** Subnet mask assigned from your ISP such as 255.255.255.240 (Example)

- 4. Default Gateway :** 24.107.88.113 (Example)

i Use the assigned default gateway from your ISP

- 5. Preferred DNS Server :** Use the 1st DNS Server from 'Assigned IP Address from My ISP'

i Contact you ISP to acquire the IP address of their DNS server.

- 6. DDNS Server :** Use the DDNS server

i The same site you will register later to utilize a DDNS service.

- 7. Web Port :** 80

i You may select any number between 1025 ~ 60000.

- 8. Control Port :** 7777

i You may select any number between 1025 ~ 60000.

- 9. Video Port :** 7778

i You may select any number between 1025 ~ 60000.

- 10. Audio Transmit Port :** 7779

i You may select any number between 1025 ~ 60000.

- 11. Audio Receive Port :** 7780

i You may select any number between 1025 ~ 60000.

Case D: Dynamic IP + DSL/Cable Modem [Connected directly to the IP Camera]

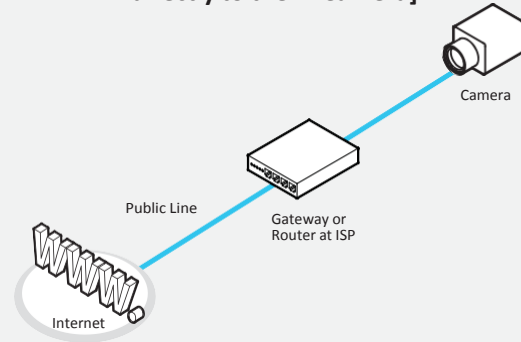

i To connect the IP camera directly to a modem, power down and reset the modem. Leave the modem powered down until configurations are finalized with the IP camera and the IP camera has been connected correctly to the modem. Then power on the modem, followed by the IP camera.

Configure your IP Camera's TCP/IP properties as follows:

- 1. Network Type :** DYNAMIC
- 2. DDNS Server :** Use the DDNS server

i The same site you will register later to accommodate dynamic IP from your ISP.

- 3. Web Port :** 80

i You may select any number between 1025 ~ 60000.

- 4. Control Port :** 7777

i You may select any number between 1025 ~ 60000.

- 5. Video Port :** 7778

i You may select any number between 1025 ~ 60000.

- 6. Audio Transmit Port :** 7779

i You may select any number between 1025 ~ 60000.

- 7. Audio Receive Port :** 7780

i You may select any number between 1025 ~ 60000.

Network Setup - Port Forwarding

After entering the correct TCP/IP settings, you are ready for 'Port Forwarding' (Cases A, B).

1. Record the TCP/IP settings of your IP camera for future reference. You may need this information to access your IP camera and to configure 'Port Forwarding'.

IP Camera TCP/IP Settings	
IP Address	
Subnet Mask	
Default Gateway	
Preferred DNS Server	
DDNS Server	
Web Port	
Control Port	
Video Port	
Audio Transmit Port	
Audio Receive Port	

2. After clicking 'Apply', the system will prompt for a reboot. Please allow the system 50 seconds to reboot and accept the changes. After 50 seconds, close the configuration screen. The view will display 'Trying to Reconnect'. If the ACTIVE light on the IP camera has gone off and is now back on again flashing, the IP camera has rebooted. After the system reboots completely, remove the power supply from the unit and close Internet Explorer.
3. Return your PC/Laptop TCP/IP properties to their original settings.
4. Before installing the IP camera, you must use 'Port Forwarding' on your personal router (Cases A, B).

You will need to forward 5 ports:

- Web Port
- Control Port
- VideoPort
- Audio Transmit Port
- Audio Receive Port

All the ports will be forwarded to the IP address you assigned to the IP Camera.

In the example above, you would forward:

- 8888 → 192.168.0.200
- 7777 → 192.168.0.200
- 7778 → 192.168.0.200
- 7779 → 192.168.0.200
- 7780 → 192.168.0.200

i For information on how to use 'Port Forwarding', please read Appendix C.

Network Setup - Starting IP Camera

After forwarding correctly the Web Port, Video Port, Control Port and two Audio Ports through your router (if applicable), install the IP camera in a proper location.

1. Locate the serial number located on the label attached to the bottom of the IP camera, you will need this for DDNS registration.
2. Connect the IP camera to your router or cable/DSL modem (per your network scenario) via a Cat5/5e UTP Ethernet network cable.
3. Supply power to the IP camera (if not using a PoEswitch)
4. After 1 minute, verify the IP camera indicators:
 - ACTIVE : Flashing
 - LINK : Flickering/Solid
5. After configuring Port Forwarding on your router (if necessary), access your IP camera on your local network by opening Internet Explorer and entering the IP address and Web Port assigned to the IP camera.

i Examples: <http://192.168.0.200:8888> or <http://24.106.88.123>

i If you left your Web Port set to 80, do not specify the port in the Address Bar to access the IP Camera.

6. Access your IP camera via the Internet :

If you use Case B, C

- 1) Open Internet Explorer.
- 2) Type the IP of the IP camera.

If you use Case A, D

- 1) Open Internet Explorer.
- 2) Visit the DDNS website.
- 3) Register the IP camera.
- 4) Give the DDNS server 10 minutes (MAX) to locate your IP Camera's IP information. You may reboot the server to send an immediate request to our DDNS server.
- 5) After your camera is connected, select your camera.

i The difference between B and C is that B needs to set the port forwarding.

i Since the type of DDNS differs from the service type, refer to the related service site.

Web Viewer Screen - Basic Screen

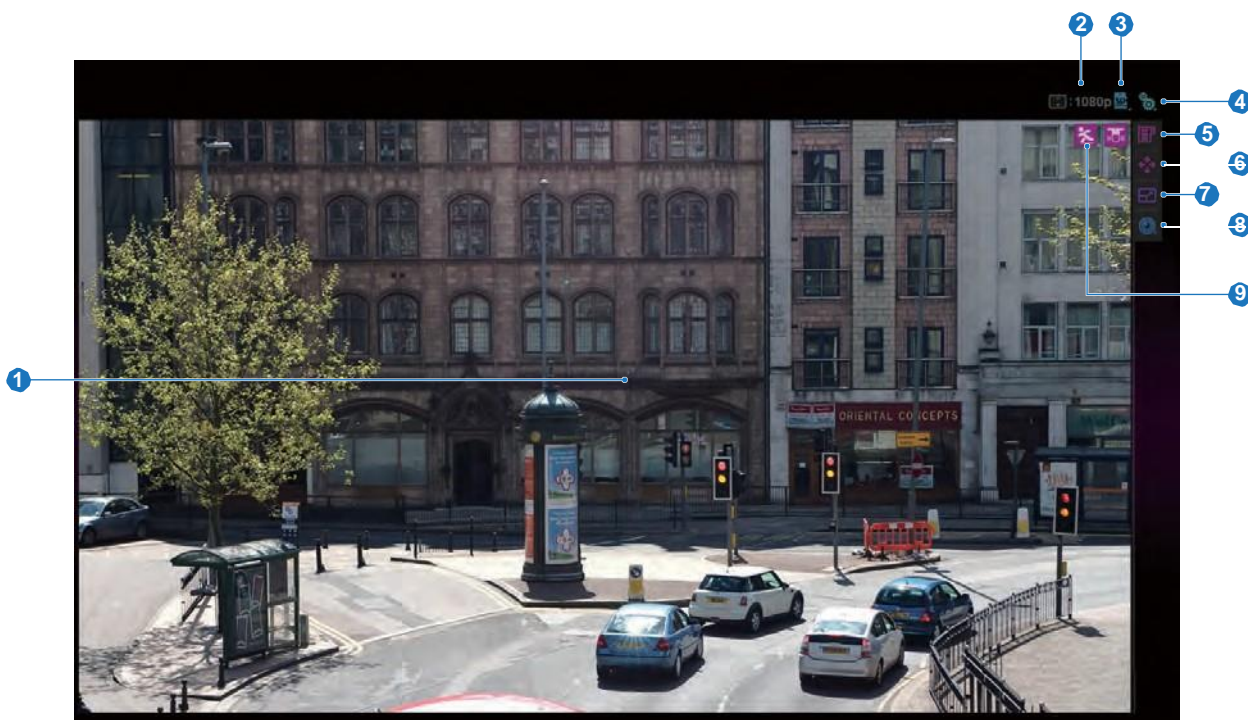

⊠ Web viewer is optimized with Windows XP or above and Internet Explorer browser.

① Live video display. This displays live video stream from the camera.

② Resolution. The resolution information of the video currently on display.

③ SD Card Search. Searching or Playing images stored in the SD Card.

④ Setup popup button. Click it to open the camera's setup page. This allows you to setup the camera's Video, Network, Events, System etc.

⑤ Control tab button. Click the button to extend the panel for full control of the web-viewer's function.

⑥ PTZ control button. Click the button to extend the panel to control the camera's Pan, Zoom, Preset, Tours etc.

⑦ Full screen button. Click the button to extend the display to full screen. Press 'Esc' or 'Enter' to return to normal mode.

⑧ Camera Setup button. Click the button to open the Setup page to setup the camera's image settings such as lens, white balance, auto exposure, BLC etc.

⑨ Event alert icon. If Alarm in and Motion detection are detected, below icons will appear.



<Alarm Input> <Motion Detection>

Web Viewer Screen - Control Tab

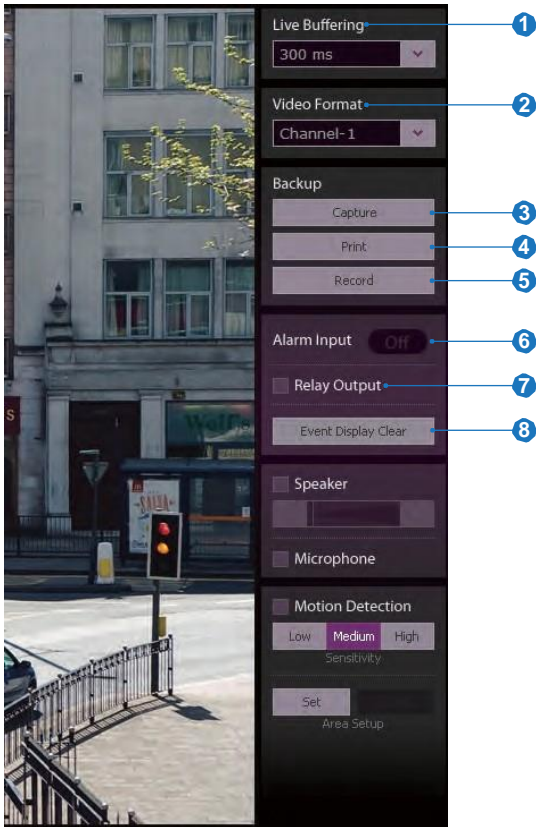

- 1 Live Buffering - When the camera's image is unsmooth due to bad network connection, you can setup the camera to delay streaming live video to adjust and improve image quality. The camera will store live images for the set duration (in milliseconds).
- 2 Video stream - Select which camera stream to display in the live view screen.
 - ☒ Refer to 'Setup > Basic > Video' to setup the Video Stream.
- 3 Capture - Capture the live video as a BMP or JPG file. The location and file name can be decided after clicking the button.
- 4 Print - Print the camera's current live image for your records.
- 5 Record - If you click this button, the current live video will be stored as AVI format file in your PC. During the recording, you cannot change the Video Format. If you change the Video Format, the recording will stop.
 - ☒ Recoding directory:
[Windows installation driver:\Users\username\AppData\LocalLow\IP_NETWORK_CAMERA\RECORD\MAC ADDRESS](#)
- 6 Alarm Input Status - Shows the Alarm Input status. If the status of alarm input becomes On, the 'Off' button will be changed to 'On' button and event alert icon (🔔) will be displayed on the 'Live video display'. If alarm is removed, the alarm input status is reset.
 - ☒ Regardless of alarm status, the Alert Icon will remain unless 'Event Display Clear' button is clicked.
- 7 Relay Out - Enable or Disable relay out function.
- 8 Event Display Clear - Remove Event Alert Icons resulted from Alarm Input or Motion detection.

Web Viewer Screen - Control Tab

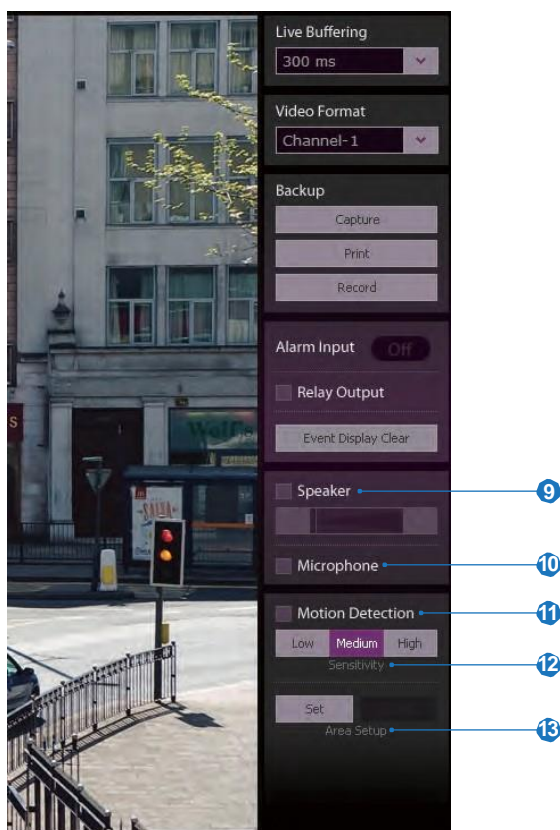

9 Speaker Control - Enable/Disable Audio stream received from the camera and Volume control of the speaker in the computer.

10 Mic Control - Enable/Disable the Audio stream to the camera.

11 Motion Detection - Enable or Disable motion detection function. 'Area Setup' below must be set in advance. Event Alert Icon (🚨) will appear on the screen if 'Motion Detection' is activated. Icon will remain unless 'Event Display Clear' button is clicked.

⚠ While the motion detection is activated, this function is de-activated momentarily if the OSD and OSD menu is shown on the screen. It is re-activated once the OSD and OSD menu disappear.

12 Sensitivity - Define the sensitivity of motion detection. If High is selected, it will detect very small motion while it becomes relatively insensitive when Low is selected.

13 Area Setup - Setup the target area for motion detection.

- 1) If 'Set' button is clicked, Live screen will display a grid to help area setup.
- 2) By clicking or dragging mouse on the grids, create or erase the masks on the main view.
- 3) Motion detection is effective in the masked Area.
- 4) Save setting by clicking 'Save' button.

⚠ Area Setup is possible only on the Ch No.1 in the 'Video Format'. If you change the video format, motion detection area will return the setup to its default settings.

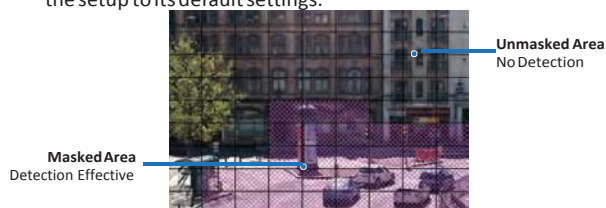

Web Viewer Screen - PTZ Control

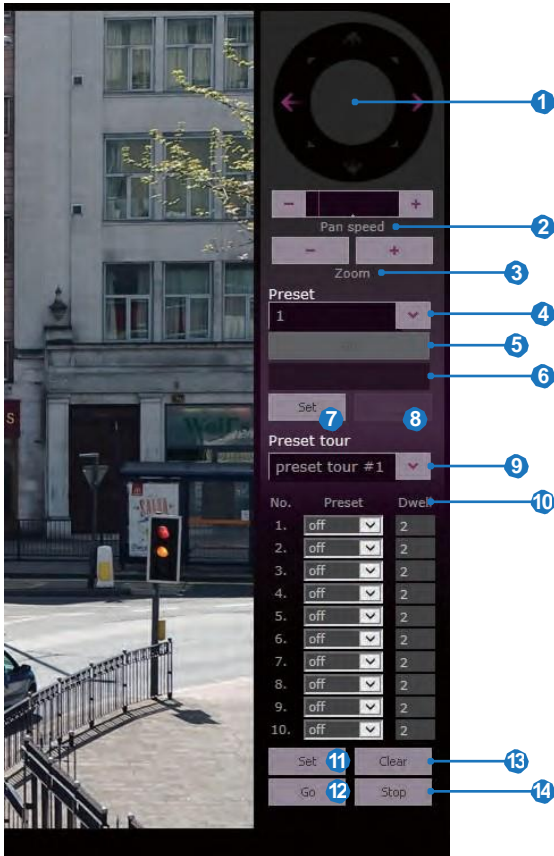

- 1 Pan-tilt wheel buttons - The Pan-tilt wheel enables you to move the camera directions by clicking the corresponding arrow buttons. To move the camera, click and hold the direction arrow. To stop the camera's movement, release the button.
- 2 Pan-tilt speed slider - The camera's pan-tilt speed is controlled by clicking the '+' or '-' buttons, or by dragging the red-lined slider in the center.
- 3 Zoom control button - Zoom in and out of the camera's image by clicking the '+' or '-' buttons.
- 4 Preset Selection - View and select a preset number from the drop down list.
- 5 Go Button - Move the camera to a selected preset.
- 6 Name Preset - Name the current preset. Max. 9 characters are allowed (including space).
- 7 Set Button - Save current location at selected preset.
- 8 Delete Button - Delete a location of a selected preset.
- 9 Preset Tour - Select a Tour from the drop-down list.
- 10 Tour Setup - Select a preset and set the preset's dwell time during the tour before moving to the next preset. At least 2 presets must be setup prior in order to properly setup a preset tour.
- 11 Set Button - Save the current preset tour changes.
- 12 Go Button - Press 'Go' button to start running a tour.
- 13 Clear Button - Clear the selected tour settings.
- 14 Stop Button - Stop running the selected preset tour.

Camera Setup - Camera Setup

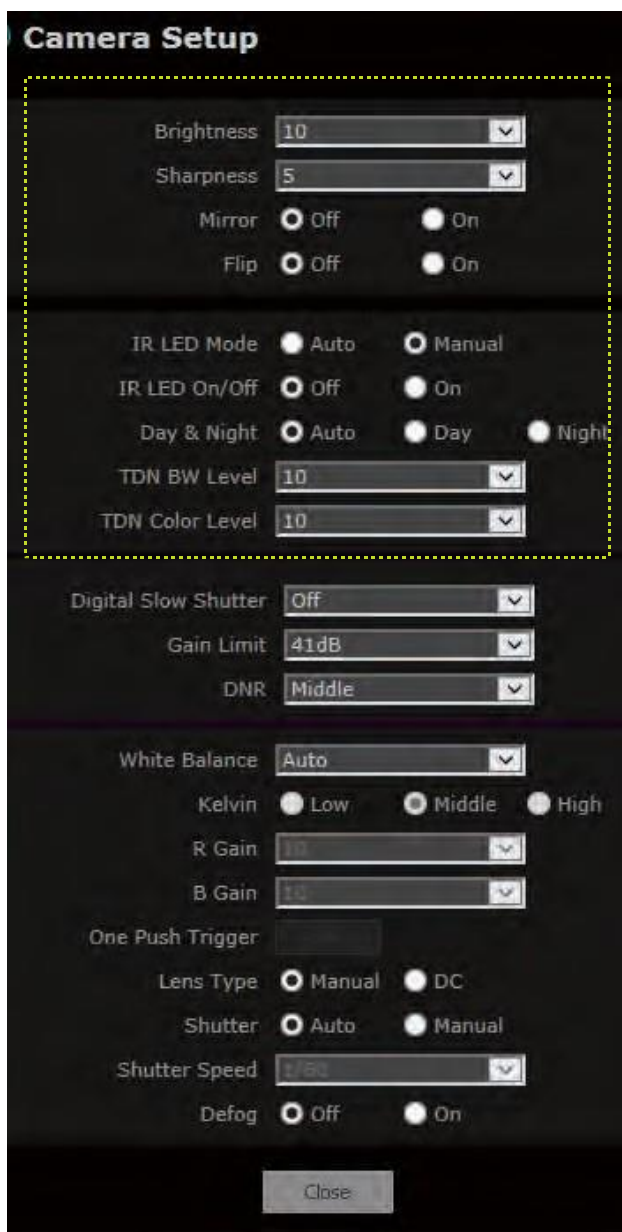

Brightness

Set the brightness of the camera's image from 0~20. The higher the number, the brighter the camera's image will appear. Default is 10.

Sharpness

Sets the image sharpness. The higher the number, the sharper the image.

Mirror

Reverse the video from side to side.

Flip

Reverse the video from up to down.

IR LED Mode

Applied for Cameras with IR LED only.

Auto: IR will be set automatically.

Manual: IR can be set manually. 'Night' must be selected at 'Day & Night' option for manual control of IR.

Day & Night

Auto: In this mode, the IR cut filter is removed automatically depending on the light conditions.

Day: In this mode, the IR cut filter is applied to the image sensor all the time. Thus, the sensitivity will be reduced in the dark light condition but better color reproduction performance are obtained.

Night: In this mode, the IR cut filter is removed from the image sensor all the time. The sensitivity will be enhanced in the dark light condition but the image will be in black and white.

TDN BW Level

The light levels at which the camera will switch from Day mode into Night mode when Day & Night mode is Auto. The higher the number, the lower the light level. This number should be lower than the value of TDN Color Level.

TDN Color Level

The light levels at which the camera will switch from Night mode into Day mode when Day & Night mode is Auto.

Camera Setup - Camera Setup

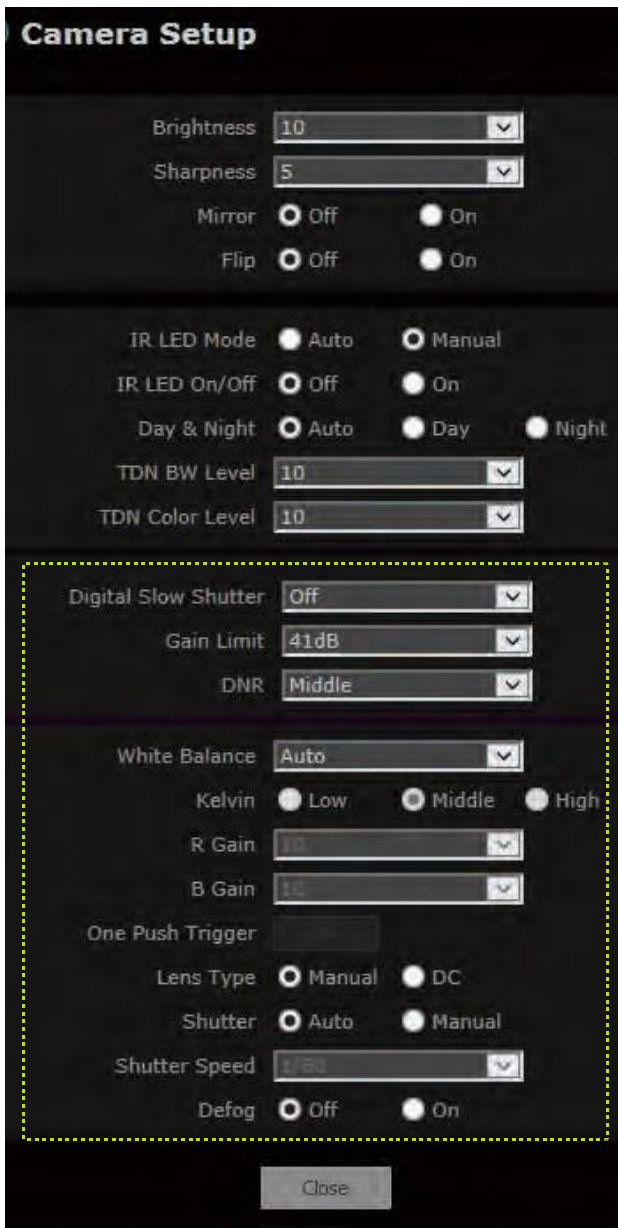

Digital Slow Shutter

Slow shutter mode decreases the speed of the shutter in low light to improve image quality. The slower the shutter, the brighter the image. However, this can also cause ghosting when fast motion occurs.

Gain Limit

Maximum light gain settings in low light conditions. Select from 0dB (least light) to 41dB (most light). Default value is 41dB.

DNR

If reduces the noise caused by 'AGC' action. If set towards 'HIGH', the noise will be reduced but the ghost effect on moving objects will be increased.

White Balance

Auto: White Balance is set automatically based on current conditions.

Auto-Ext: White Balance is set automatically under the assumption of special external illumination like halogen.

Indoor: White Balance is set automatically under the assumption of indoor illumination settings.

Outdoor: White Balance is set automatically under the assumption of outdoor illumination settings.

Preset: White Balance is fixed based on current lighting. Click 'Set' in One push Trigger.

Manual: The R/B gain level can be set up manually.

Kelvin

Determines the warmth or coolness of the light. Select from Low, Middle, or High. Default value is Middle.

One Push Trigger

Click 'Set' continuously until screen image attain an ideal WB.

Shutter

If Shutter is set to Auto, shutter speed is adjusted automatically according to the surrounding illumination.

Shutter Speed

The faster the shutter speed is, moving objects will appear without ghosting effect. However, this will also cause the picture to appear darker if there is no sufficient lighting. This menu is activated when Shutter is set to Manual.

LED Saturation

Control the LED Saturation.

Defog

Eliminate amount of fog on display screen.

Setup - Video Setup

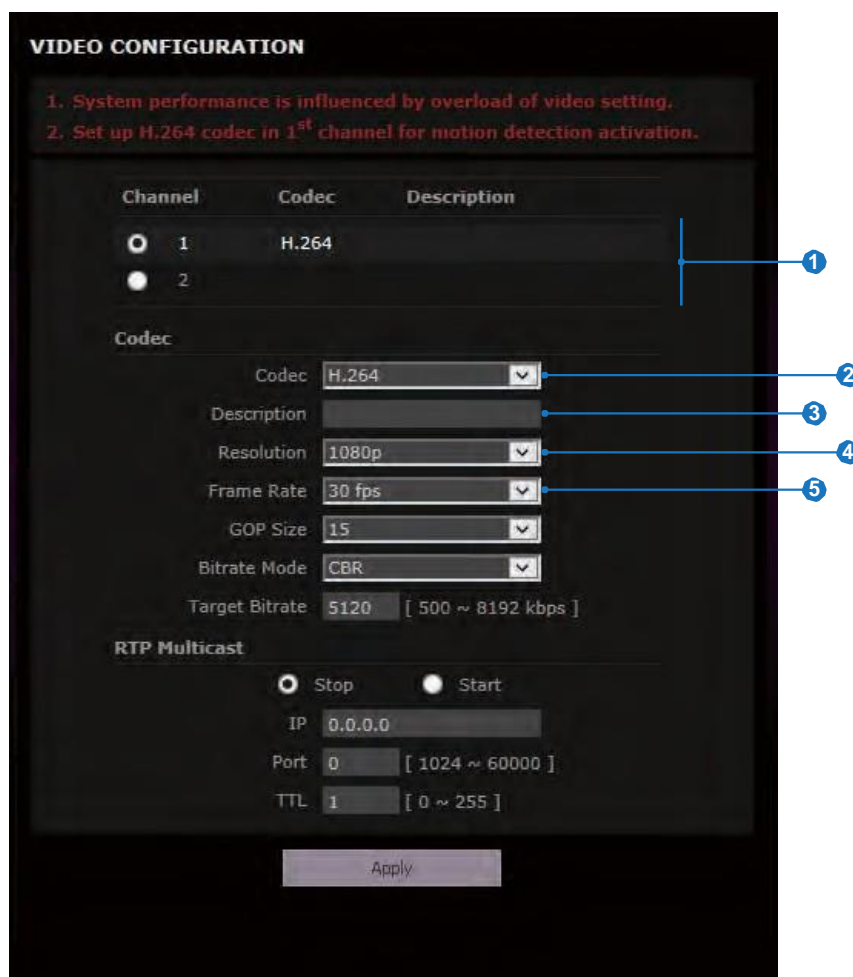

1 Live Video Channel/ Stream Setup

The video can be configured to variety settings with a combination of codec and resolution. The camera performance has to be considered when setting multiple channels/ streams. This may influence the camera's performance.

☒ Channel 1 must be set to H.264 in order to activate 'Motion Detection'.

2 Codec

Choose the video codec. According to the selected codec, the subcategories will change automatically. When MJPEG is selected, it will be able to set whether to use the relevant channel for image transfer. The channel for image transfer can only be set to channel 2.

3 Description

Input a description for the selected channel. Max. 15 characters are allowed.

4 Resolution

Select the video resolution.

☒ Available resolution depends on the codec setup between the channels.

	NTSC	PAL
1080p/i	1920 x 1080	1920 x 1080
D1	720 x 480	720 x 576
CIF	352 x 240	352 x 288
QCIF	176 x 120	176 x 144

<Resolution Video Format>

5 Frame Rate

Select the maximum Frame Rate up to 30fps.

☒ Available Frame Rate can be different although same codecs were set up.

Setup - Video Setup

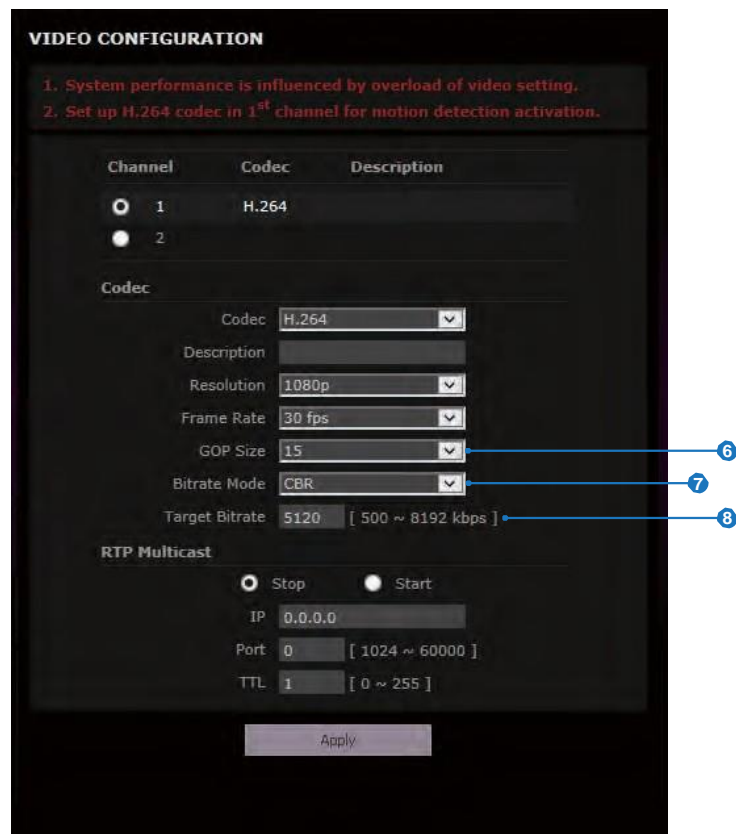

6 GOP(Group of Pictures)Size

Set up the number of frames (P-frame) which contain only changed information based on basic frame (I-frame) from 1 to 30. In videos with lots of movement, if you set GOP size bigger, only the number of P-frames is bigger. As a result, video resolution will be low but 'File size' and 'Bit-rate' will decrease.

※ GOP(Group of Pictures) Size is..

I-frame and P-frame can be created for MPEG4 and H 264 video compression. I-frame(=key-frame) means the whole image data for one specific scene of video. P-frame is image data which has been changed information compared to I-frame. GOP is made up of one I-frame and corresponding several P-frames. To improve video quality, set the number of P-frames smaller. To decrease image size, set the number of P-frames bigger.

7 Bitrate Mode

Select the bit rate control scheme of video compression from CBR (Constant Bit Rate) or VBR (Variable Bit Rate).

Quality

For VBR, The Target Quality of video can be setup. Set from 1 to 5(Highest). Default is 3.

CBR

To guarantee the designated constant bit rate, the quality of video are controlled in this mode. The quality of video is likely to be varying when network traffic is changing.

VBR

To guarantee the designated quality, the bit rate of video stream is changed in this mode. The frame rate of video is likely to be varying when network traffic is changing.

※ This category will be disabled if you select the codec.

8 Target Bitrate

For CBR, you can set the Target Bitrate. Set the target bitrate value from 500 to 8192 kbps. Default is 5478.

Image Transfer

When MJPEG codec is selected, it will be able to set whether to use the relevant channel for image transfer. This option is available only for Channel 2.

Setup - Video Setup

VIDEO CONFIGURATION

1. System performance is influenced by overload of video setting.
2. Set up H.264 codec in 1st channel for motion detection activation.

Channel	Codec	Description
<input type="radio"/> 1	H.264	
<input checked="" type="radio"/> 2		

Codec

Codec:

Description:

Resolution:

Frame Rate:

GOP Size:

Bitrate Mode:

Target Bitrate: [500 ~ 8192 kbps]

RTP Multicast

Stop Start

IP:

Port: [1024 ~ 60000]

TTL: [0 ~ 255]

9 RTP Multicast

To activate RTP Multicast:

1. Click "Start" button
2. Enter accessible RTP Multicast IP, port for video stream control, RTP packet TTL
3. Click "Apply". Click "Stop" button to disable RTP Multicast.

☒ You can setup individual RTP Multicasts for each channel/ stream.

10 Click 'Apply' to save all changes.

☒ Click the 'Apply' button after completing setup for each channel.

Setup - Audio Setup

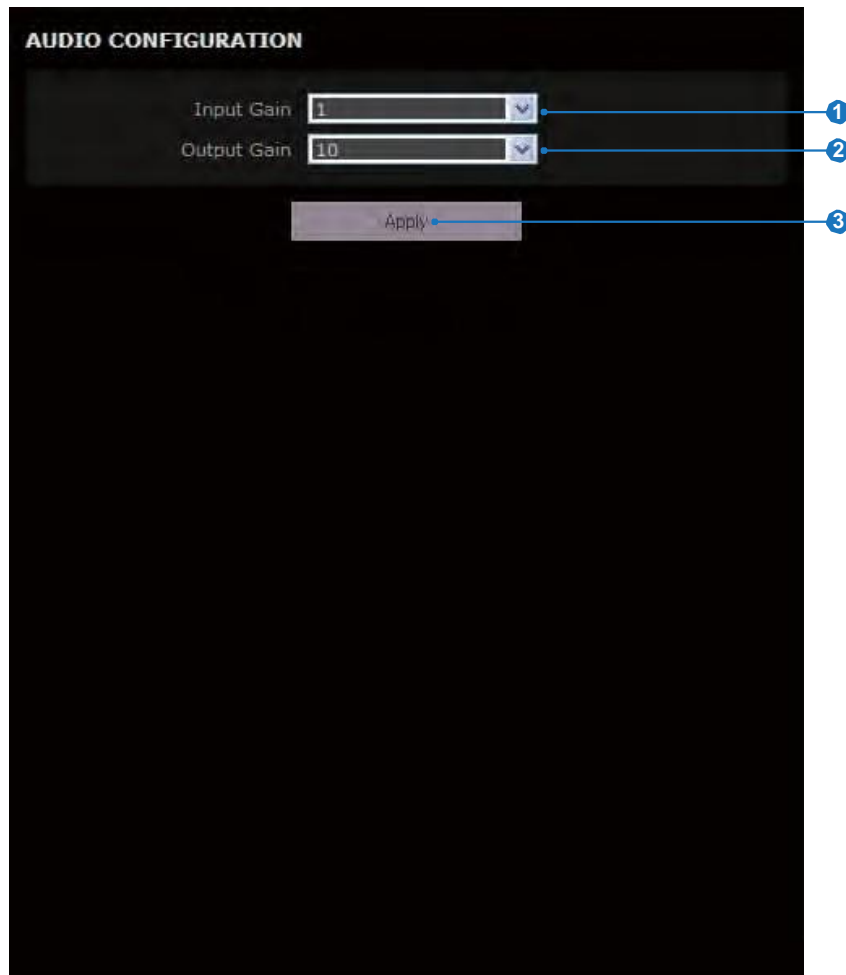

- 1 Input Gain**
Adjust the input gain of audio.
- 2 Output Gain**
Adjust the output gain of audio. Output gain 0 is mute.
- 3** Click 'Apply' to save all changes.

Setup - Panorama Configuration

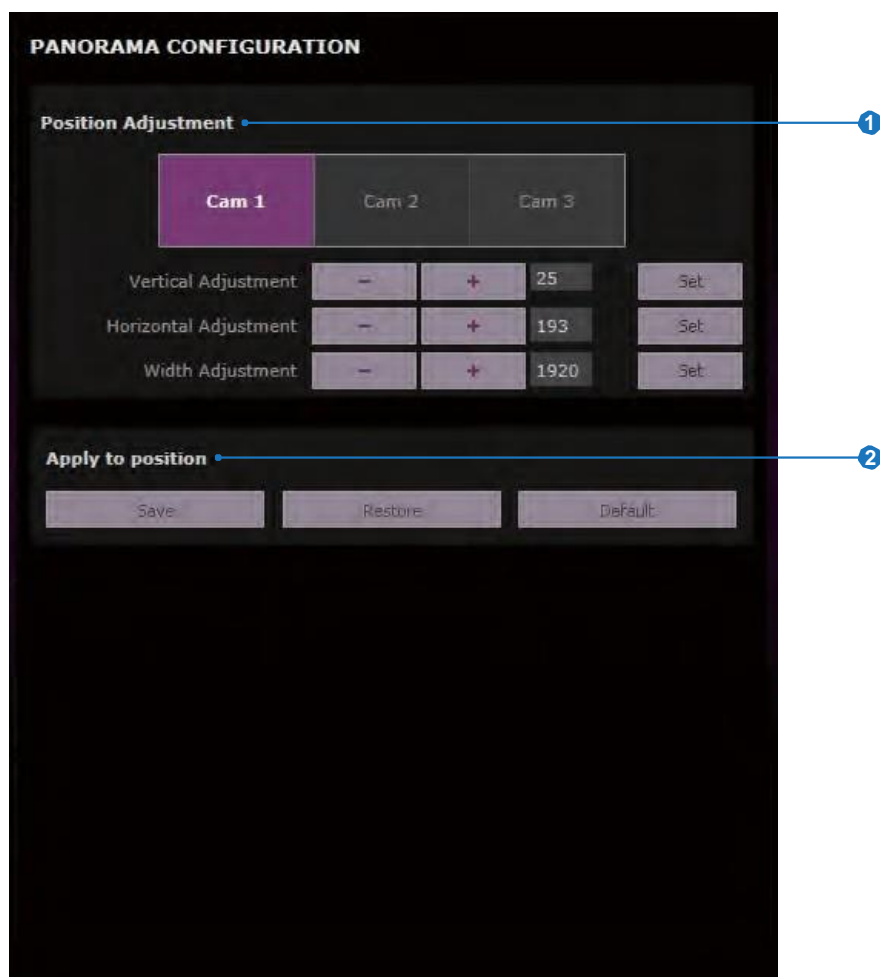

1 Position Adjustment

Adjust the video position of each individual lens.
Select a 'Cam' and adjust the position by using '-', '+' buttons.
Press 'Set' to save.

2 Apply to position

After the camera's positions have been adjusted, click 'Save'.
Restore: Restore last saved values.
Default: Restore the default value.

	Cam1	Cam2	Cam3
Vertical Position	25	12	77
Horizontal Start Position	193	241	189
Horizontal Width	1920	1695	1920

⊠ If total width adjustment is down up to 1920, you may see black video. This time, its value is set up to 1920, video is normal.

Setup - Motion Setup

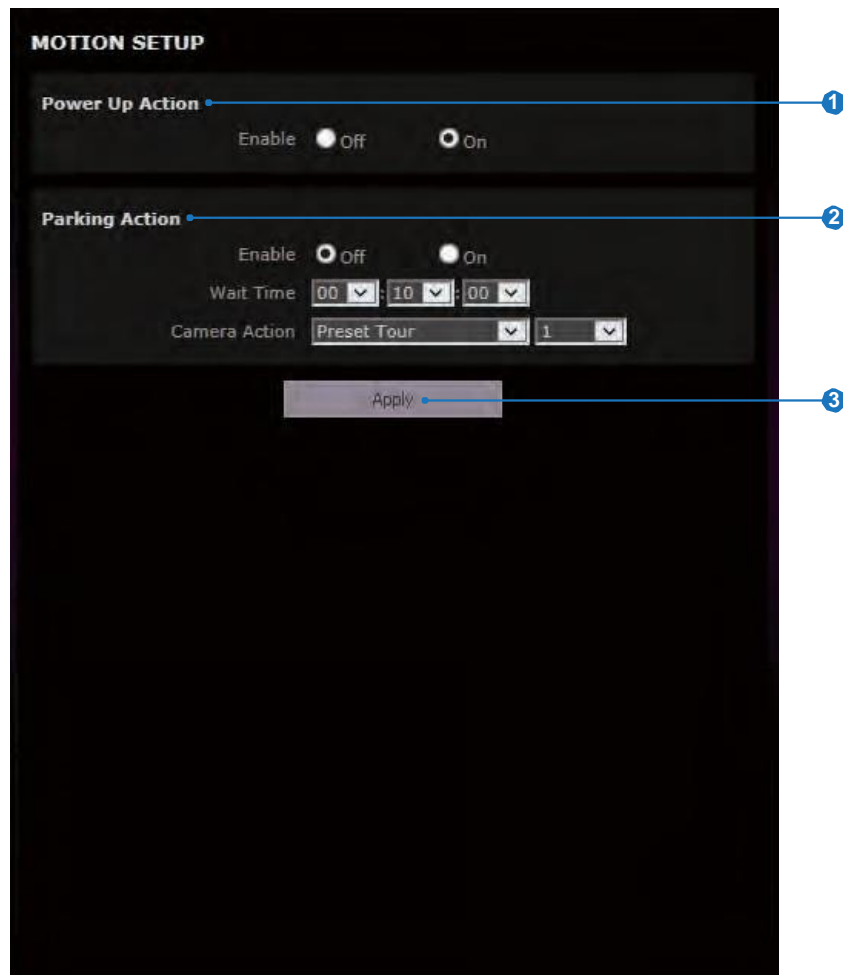

1 Power Up Action

This function enables to resume the last action executed before the camera powered down. Most of actions such as preset, pattern, scan and group are available for this function but jog actions are not available to resume.

2 Parking Action

If 'Enable' is set to 'On', the camera will run an assigned 'Camera Action' automatically if no PTZ command is running during the assigned 'Wait Time'.

☒ See section 'Web Viewer Screen_Auto map' for details of Preset, Pattern, Scan, and Group.

3 Click 'Apply' to save all changes.

Setup - OSD

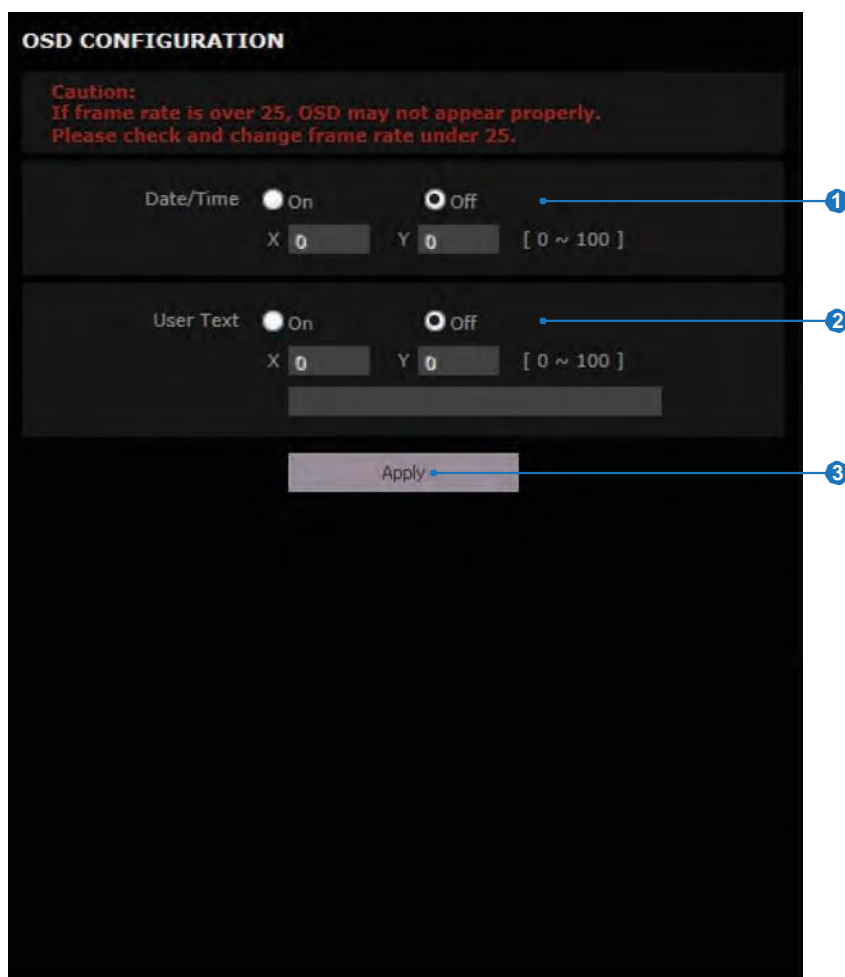

1 Date/Time

Display the current time.

- ⊠ When Date/Time is displayed, deletion of the motion detection mask on the area of Date/Time display are strongly recommended to prevent misdetection on the time's changing numbers. See Motion Detection Setup for more information.

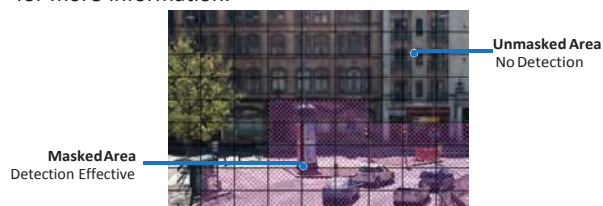

2 User Text

Display specific text on the camera's view.
Support up to 30 characters.

- 3 Click 'Apply' to make above setting effective.

Setup - TCP/IP Setup

The screenshot shows the 'TCP/IP CONFIGURATION' window. At the top, 'Network Type' has radio buttons for 'Static' and 'Dynamic'. Below is the 'IP Setup' section with input fields for 'IP Address' (192.168.1.118), 'Subnet Mask' (255.255.255.0), 'Default Gateway' (192.168.1.1), and 'Preferred DNS Server' (168.126.63.1). The 'Port Setup' section lists 'Control Port' (7777), 'Video Port' (7778), 'Audio Transmit Port' (7779), 'Audio Receive Port' (7780), 'HTTP Port' (80), and 'HTTPS Port' (443). At the bottom, 'IPv6 Setting' has an 'Enable' checkbox, and an 'Apply' button is at the very bottom.

1 Network Type

Select the network type from Static Mode for fixed IP or Dynamic Mode for dynamic IP address. If Static is selected, manually enter the camera's IP Address, Subnet Mask, Gateway, DNS Server and all ports. If Dynamic is selected, the camera's network settings will be assigned automatically by your DHCP router. If you click 'Apply', the system will re-boot. To access the camera again, open an Internet Explorer browser and enter the camera's new IP address in the address bar.

2 IP Address

View or edit the camera's IP address. The address consists of four numbers separated by dots, each ranging from 0 to 255.

3 Subnet Mask

View or edit the camera's Subnet Mask.

4 Default Gateway

View or edit the Gateway IP Address. This is your router's public IP address, and will be used if you are trying to access the camera remotely over the internet.

5 Preferred DNS Server

View or edit the DNS server IP address.

6 Port

The camera requires five ports for different services. To get those services separately, unique port number must be assigned to each service.

7 IPv6 Setting

Create an IPv6 address. If you click 'Apply' after checking the IPv6 box, the system will re-boot. If you re-visit this screen after the camera completes rebooting, the IPv6 address will be shown.

⚠ To use IPv6, network camera has to connect with the router for IPv6.

8 Click 'Apply' to save all changes.

⚠ If the network type is dynamic, the camera's IP address will in cases as below. The IP address will have to be searched again, and the camera will have to be reconnected each time.

- When the camera powers off.

- After Firmware update, Default set and reboot.

It is recommended to set a DDNS address for the camera. This allows you to connect to your camera using the same URL all the time, regardless of IP address change.

Setup - RTSP

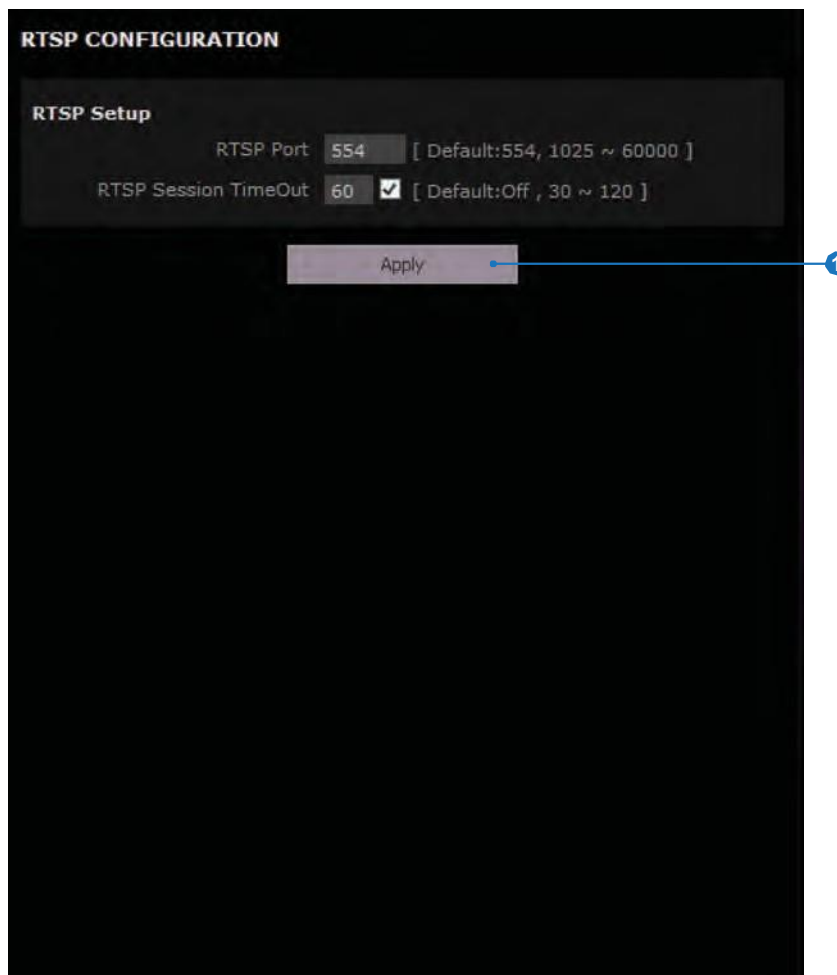

⊠ RTSP Session TimeOut

Check the check box to enable 'RTSP Session Timeout' function.
Select the duration of the time out from 30 to 120 seconds.

① Click 'Apply' to save.

Setup - ONVIF

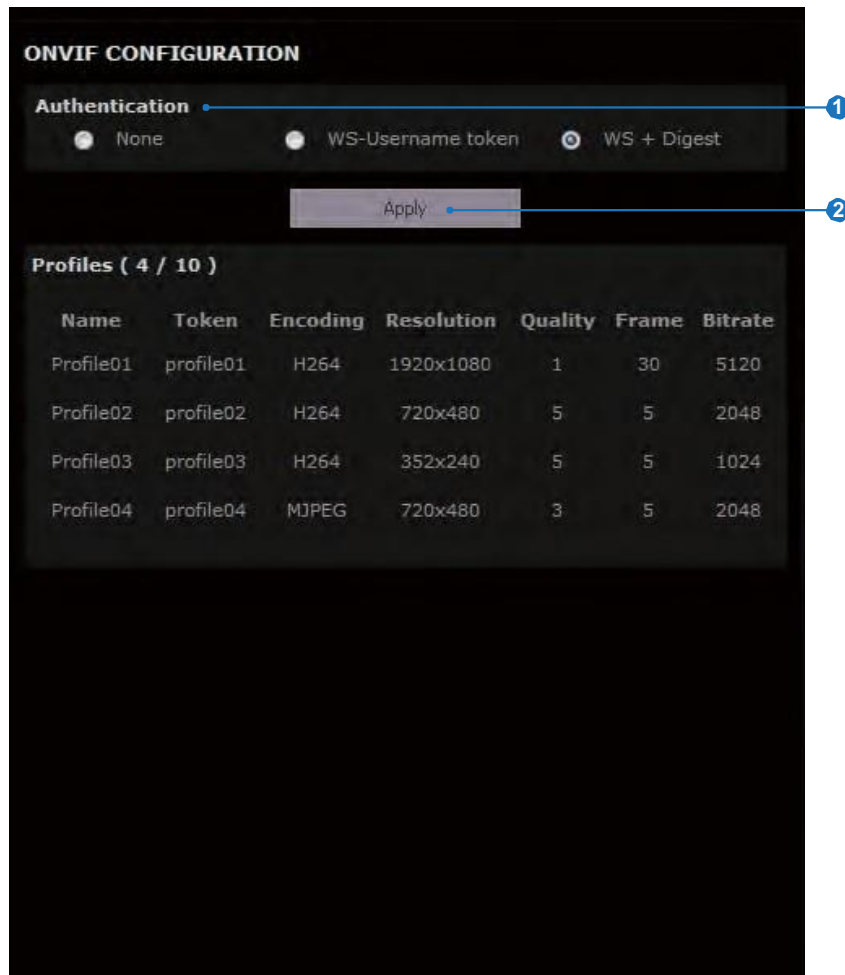

1 Authentication

- None:** Allows access without ONVIF authentication.
- WS - Username token:** Allows access with WS-User Token of ONVIF authentication.
- WS + Digest:** Allows access with WS-User Token and Digest of ONVIF authentication.

2 Click 'Apply' to save all changes.

Setup - DDNS Setup

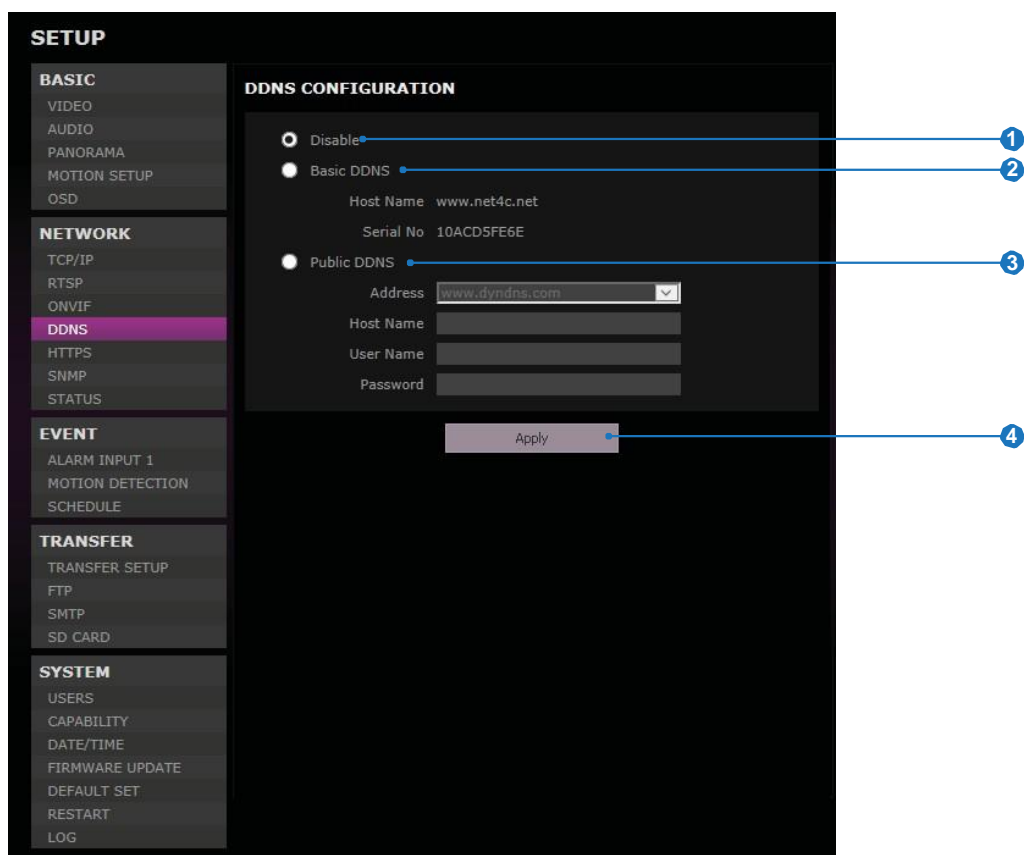

1 DDNS Disable

If it is selected, DDNS service will be off.

2 Basic DDNS

Please register the camera in net4c site so as to use net4c DDNS. Insert the serial number shown on the screen in the serial entry field.

3 Public DDNS

To use a public DDNS service, select a site listed in the list. After filling out the Host Name of the site, the setup is completed by entering the User Name and Password registered in that DDNS site.

DDNS Provider	Site Address
DynDNS	www.dyndns.com
No-IP	www.no-ip.com

⚠ If you setup DDNS properly, the IP address of your camera will update automatically whenever the IP address is changed or the system is rebooted.

⚠ If IP updating to DDNS site fails, the camera will keep trying to reconnect every 1minute.

4 Click 'Apply' to save all changes.

Setup - HTTPS Setup

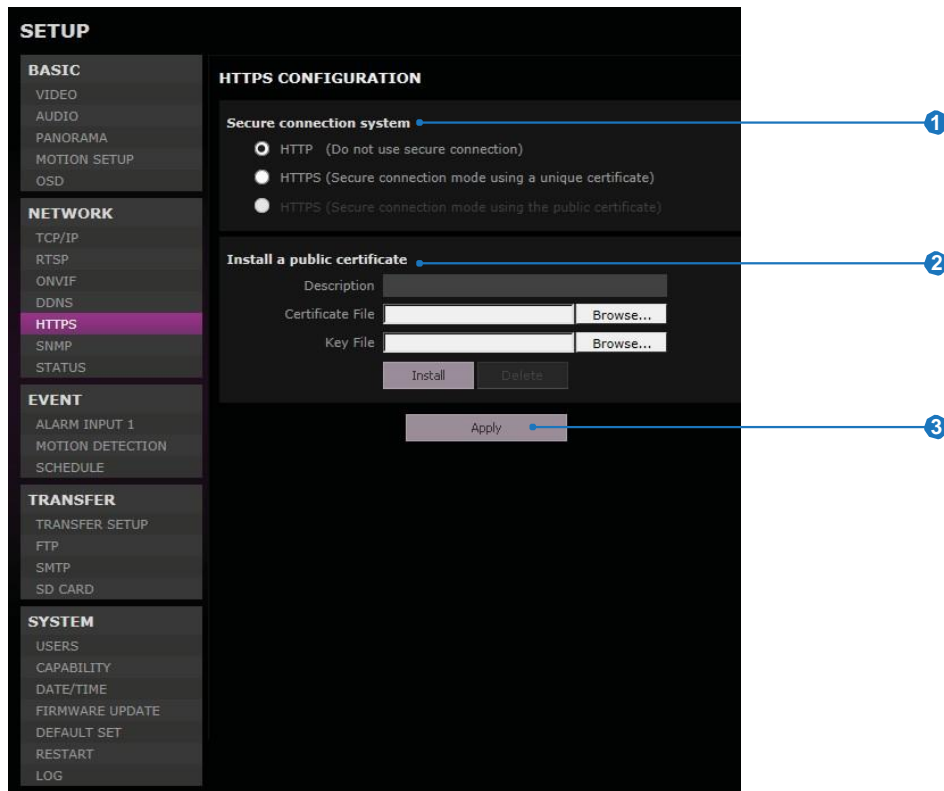

1 Secure Connection System

Secure Connection System chooses a method of security connection.

HTTP

HTTP mode does not use a security connection method.

HTTPS (Secure connection mode using a unique certificate)

This mode is a security connection method which uses the (temporary) certificate in the camera.

HTTPS (Secure connection mode using the public certificate)

This mode is a security connection method which uses a certificate issued by certificate authority.

⚠ HTTPS (Secure connection mode using the public certificate) method can be selected only if a certificate has been already installed.

⚠ When HTTPS mode is chosen, input `https://<IP Address>` to connect to the camera.

2 Install a public certificate

A certificate issued by Certificate Authority can be installed to the camera and the installed certificate can be deleted.

<How to install or delete the certificate>

- 1) Input the description (name) of a certificate.
- 2) Click 'Install' after selecting the certificate files and key file to be installed.
- 3) To remove the certificate files, click 'Delete'.

⚠ While using HTTPS (Secure connection mode using the public certificate), the certificate cannot be deleted.

3 Click 'Apply' to save all changes.

Setup - SNMP Setup

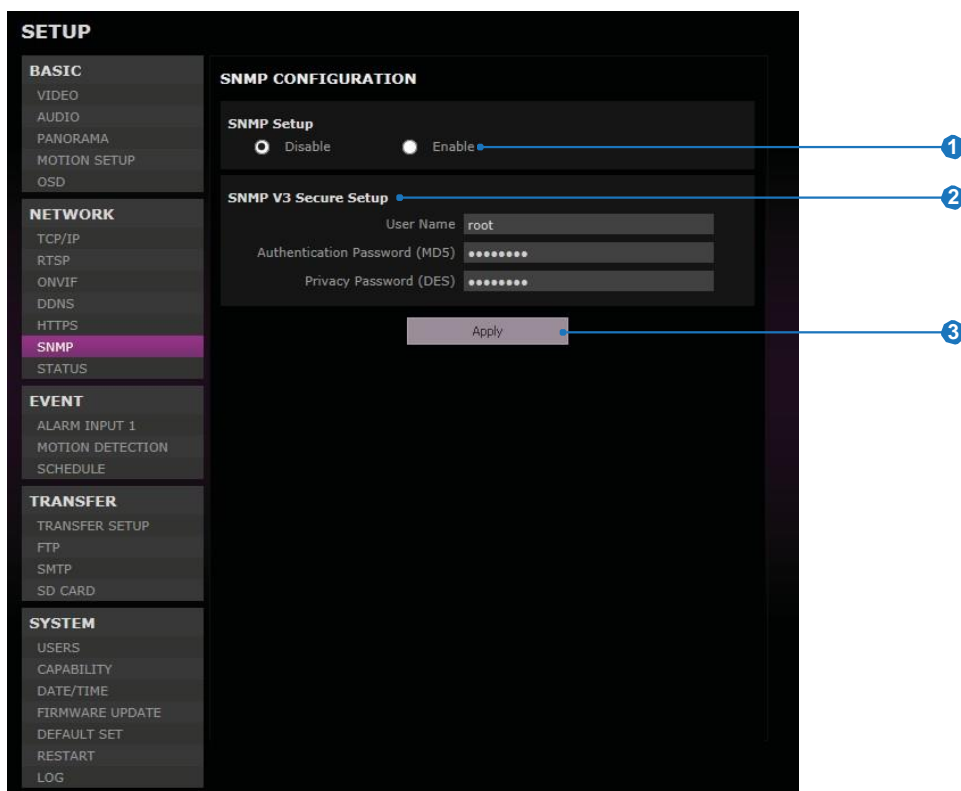

1 SNMP Setup

The camera's system information can be viewed and configured with SNMP.

2 SNMP V3 Secure Setup

The changes for configuration use version 3 and username and password should be certified at that time.

Username

Username for user authentication.

Authentication Password (MD5)

The Authentication Password (MD5) is an encryption for authentication and must be at least 8 digits long or up to 30 digits.

Privacy Password (DES)

Information protection password is a private encryption and must be at least 8 digits long or up to 30 digits.

3 Click 'Apply' to save all changes.

Setup - Status

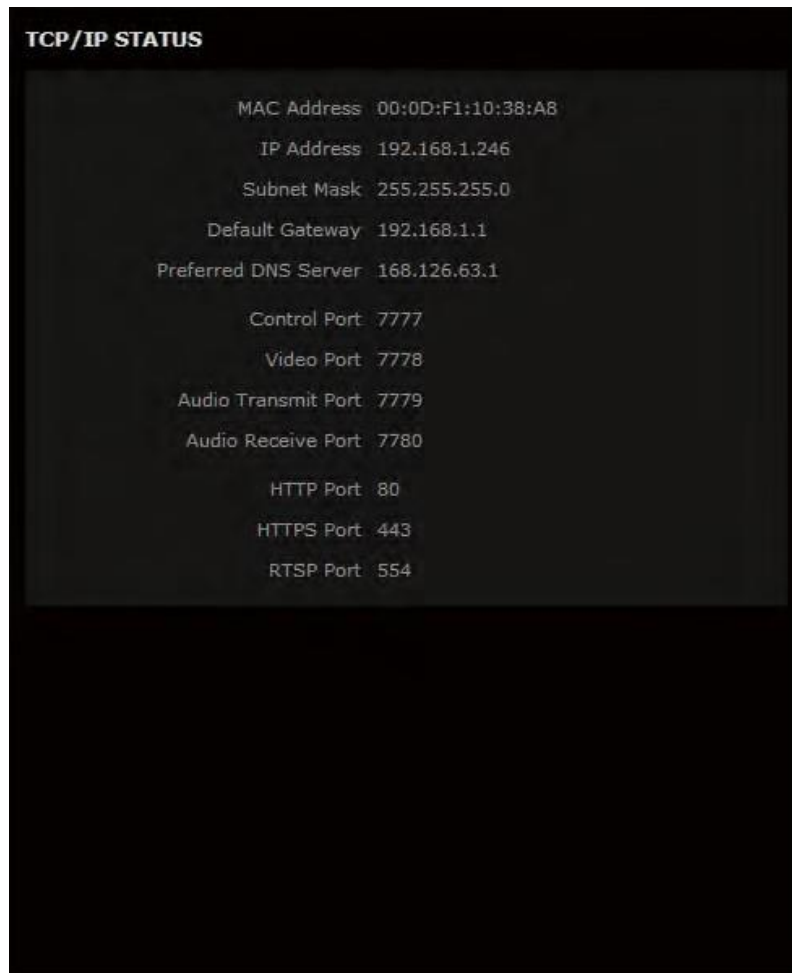

This menu shows all the information of the Network setting in the camera.
To change these settings, go to the corresponding submenu under the network settings page.

Setup - Alarm Input Setup

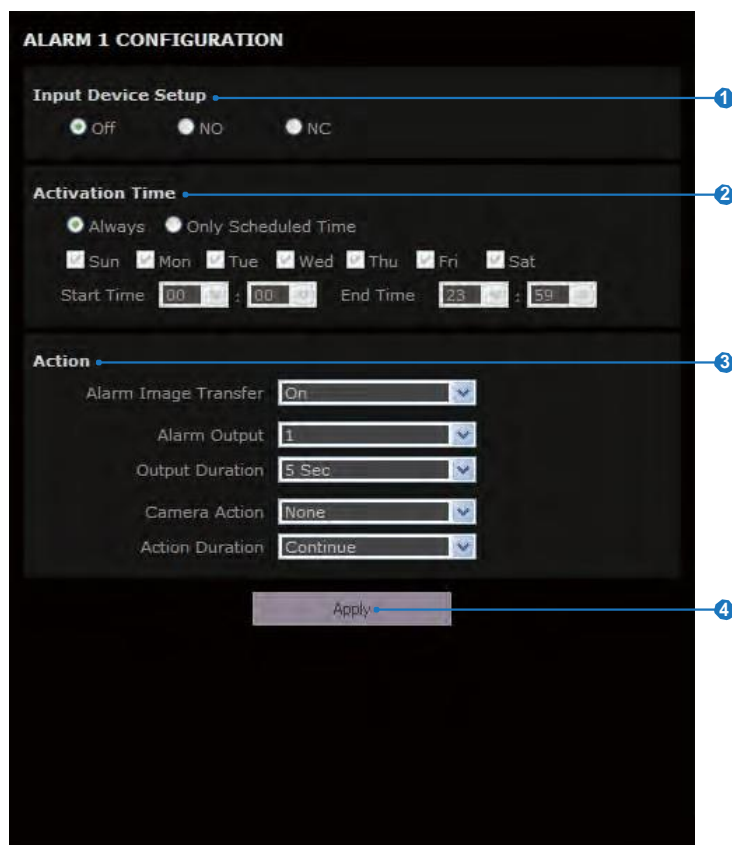

1 Input Device Setup

Select input device type from OFF / N.O. / N.C.

	Operation
Off	Ignore this Input sensor.
NO	The contact is normally open and closed when activated.
NC	The contact is normally closed and open when activated.

2 Activation Time

Select activation time from Always / Only Scheduled Time.

Always	An alarm event is activated whenever sensor Input is detected.
Only Scheduled Time	An alarm event is activated only when sensor input is detected during the scheduled time.

⊗ To setup the schedule, you need to define Start time and End time followed by selecting Days.

⊗ If End time is earlier than Start time, End time is regarded as next day.

Ex) Assume you select Tue. If you set Start time as 16:00 and End Time as 09:00, Alarm Input will work from 4:00pm Tue to 9:00am Wed.

3 Action

Define a counter action from Alarm Output / Alarm Image Transfer / Camera Action when Alarm Input is detected.

Action	Description
Alarm Image Transfer	Turn ON / OFF Image Transfer. Send image via E-mail or FTP server. (See Transfer Setup for more information).
Alarm Output	Activate alarm out (relay).
Output Duration	Select time duration to maintain output.
Camera Action	Setup the Camera Action when Alarm in.
Action Duration	Select time duration to maintain action.

4 Click 'Apply' to save all changes.

Setup - Motion Detection Setup

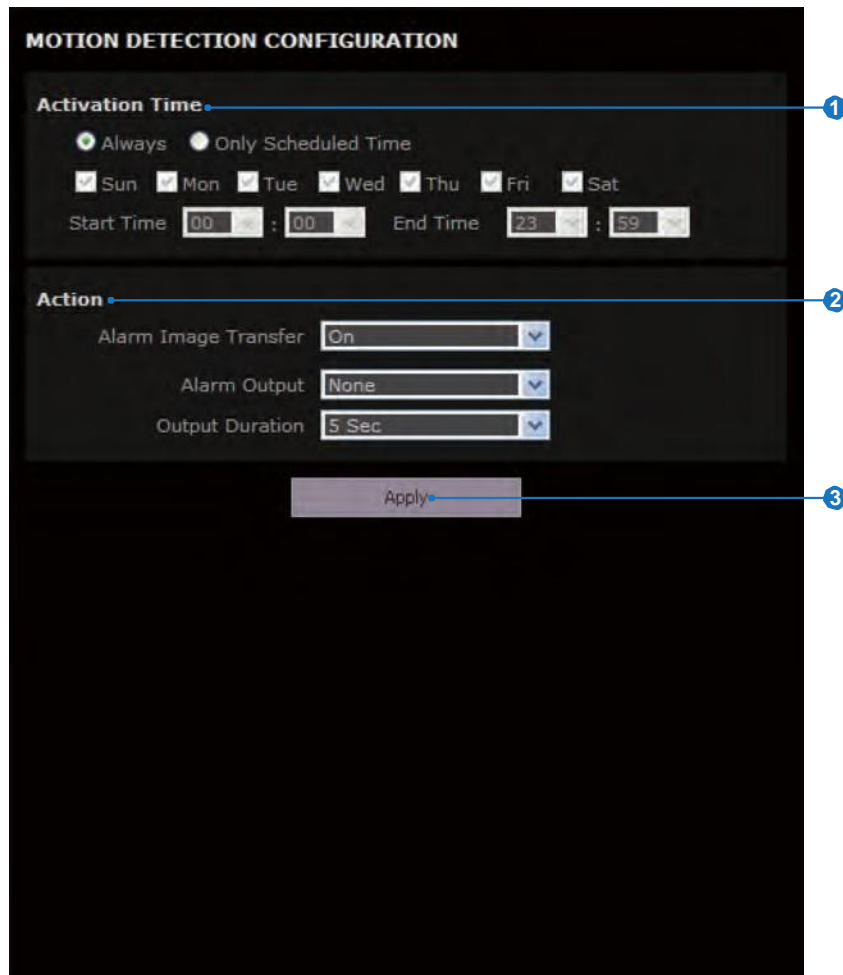

1 Activation Time

Select activation time from Always / Only Scheduled Time.

Always	An alarm is activated whenever motion is detected.
Only Scheduled Time	An alarm event is activated only when motion is detected during the scheduled time.

※ To setup schedule, you need to define Start time and End time followed by selecting Days.

※ If End time is earlier than Start time, End time is regarded as next day.

Ex) Assume you select Tue. If you set Start time as 16:00 and End Time as 09:00, Alarm Input will work from 4:00pm Tue to 9:00 am Wed.

2 Action

Define a counter action from Alarm Output / Alarm Image transfer when motion is detected.

Action	Description
Alarm Image Transfer	Turn ON / OFF Image Transfer. Send image via E-mail or FTP server. (For more detail see Transfer Setup in this chapter)
Alarm Output	Activate alarm out (relay).
Output Duration	Select time duration to maintain output.

※ "Alarm output, Output duration" can only be set with cameras which supports alarms.

3 Click 'Apply' to save all changes.

Setup - Schedule Setup

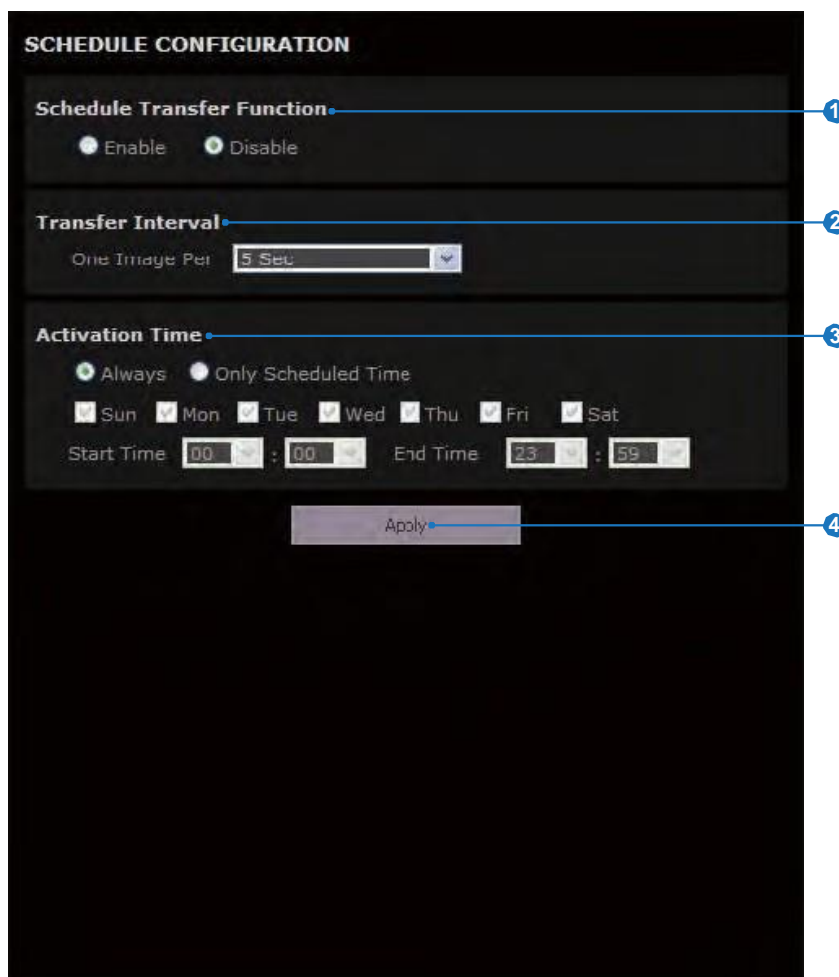

Schedule function enables you to transfer a series of images in the set time interval via E-mail or FTP. (For more detail, see 'Transfer Setup').

This function (Schedule Setup) is enabled when the codec is set to "MJPEG" for channel 2 at "Setup-Video setup".

- 1 **Enable / Disable**
Set Schedule function to be enabled or disabled.
- 2 **Transfer Interval**
Define time interval of image transfer.

- 3 **Activation Time**
Select activation time from Always / Only Scheduled Time.

Always	Transfer image at all times.
Only Scheduled Time	Transfer image during the scheduled time.

- ※ To setup 'Only Scheduled Time', you need to define Start time and End time followed by selecting Days. The setup schedule is repeated every week.
- ※ If End time is earlier than Start time, End time is regarded as next day.
Ex) Assume you select Tue. If you set Start time as 16:00 and End Time as 09:00, Alarm Input will work from 4:00pm Tue to 9:00am Wed.

- 4 Click 'Apply' to save all changes.

Setup - Transfer Setup

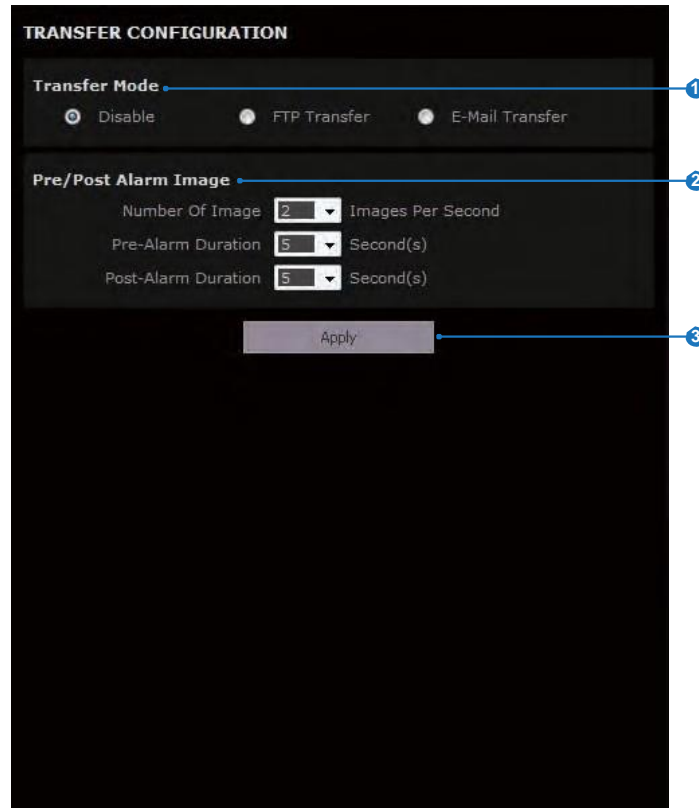

This function is enabled when the codec is set to “MJPEG” for channel 2 at “Setup-Video setup”.

1 Transfer Mode

Select from Disable, FTP and E-Mail (SMTP).

☒ To use image transfer, FTP and SMTP in the next sections must be configured properly.

2 Pre/Post Alarm Image

Image Transfer due to event is configured by setting Image transfer rate and Pre/Post alarm duration.

	Descriptions
Number of Image	Define Number of image transferred per second.
Pre-alarm Duration	Define duration of image transfer before an event.
Post-alarm Duration	Define duration of image transfer after an event.

☒ Range of Pre/Post alarm duration varies according to the number of image setting.

3 Click 'Apply' to save all changes.

Setup - FTP Setup

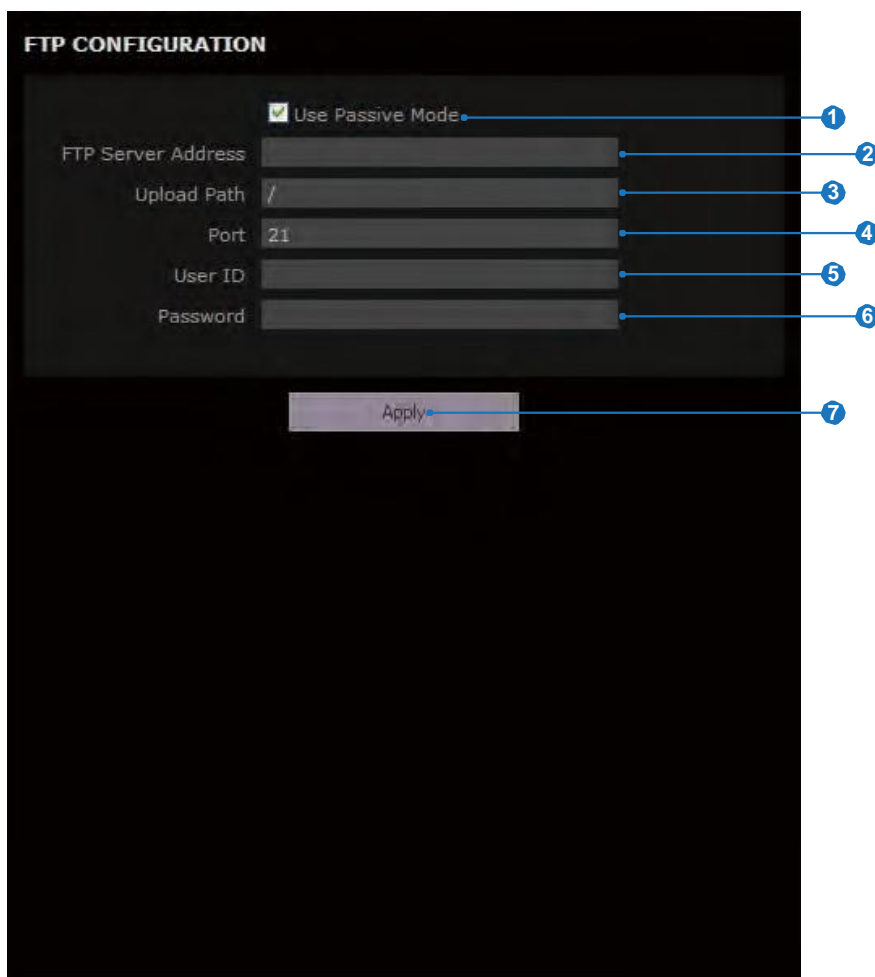

FTP CONFIGURATION

Use Passive Mode

FTP Server Address

Upload Path /

Port 21

User ID

Password

Apply

To transfer/save images to a site through FTP, FTP must be setup.

1 Use Passive Mode

Use Passive mode for FTP transfer. If this option is not checked, the transfer will be in Active Mode. Active Mode, may have transfer issues due to firewall settings. Consult your network manager for more information.

2 FTP Server Address

Enter the FTP's IP address. If IP Address form is incorrect, a Message box will appear.

3 Upload Path

Define a path in the FTP server to store the video from the camera.

4 Port

Enter the FTP Server's Port. If Port is incorrect, it will be impossible to access the FTP Server.

5 User ID

Enter the User ID to access the FTP Server.

6 Password

Enter the Password to access the FTP Server.

7 Click 'Apply' to save all changes.

Setup - SMTP Setup

The screenshot shows the 'SMTP CONFIGURATION' window. At the top, there are two radio buttons: 'Plain' (selected) and 'SSL/TLS'. Below this are several input fields: 'SMTP Server Address', 'Port' (with '25' entered), 'User ID', 'Password', 'E-Mail Sender', 'E-Mail Receiver', 'Title', and a text area for 'Message'. At the bottom center is an 'Apply' button. Ten blue callout lines with numbers 1 through 10 point to the following elements: 1. SSL/TLS radio button, 2. SMTP Server Address field, 3. Port field, 4. User ID field, 5. Password field, 6. E-Mail Sender field, 7. E-Mail Receiver field, 8. Title field, 9. Message text area, and 10. Apply button.

To send/save images by Email, SMTP needs to be setup.

1 Plain, SSL/TLS

Select the SMTP's Security mode from Plain or SSL/TLS.

2 SMTP Server Address

Enter the SMTP Server's Address. If the IP Address form is incorrect, a message box will appear.

3 Port

Enter the SMTP Server's port used in the Plain or SSL/TLS security mode.

4 User ID

Enter the User ID to access the SMTP Server.

5 Password

Enter the Password to access the SMTP Server.

6 E-Mail Sender

Enter the e-mail address of the E-Mail Sender. This will be the "From" E-Mail when the camera sends an E-mail.

7 E-Mail Receiver

Enter the e-mail address of the E-Mail Receiver. These addresses will receive notice when the camera sends an E-mail.

8 Title

Enter the title of the E-Mail to appear when the camera sends an E-mail notification.

✘ The title of the Email is limited to 40 characters.

9 Message

Enter the content of the E-Mail when camera sends an E-mail notification.

✘ The message of the Email is limited to 40 characters.

10 Click 'Apply' to save all changes.

Setup - SD CARD Setup

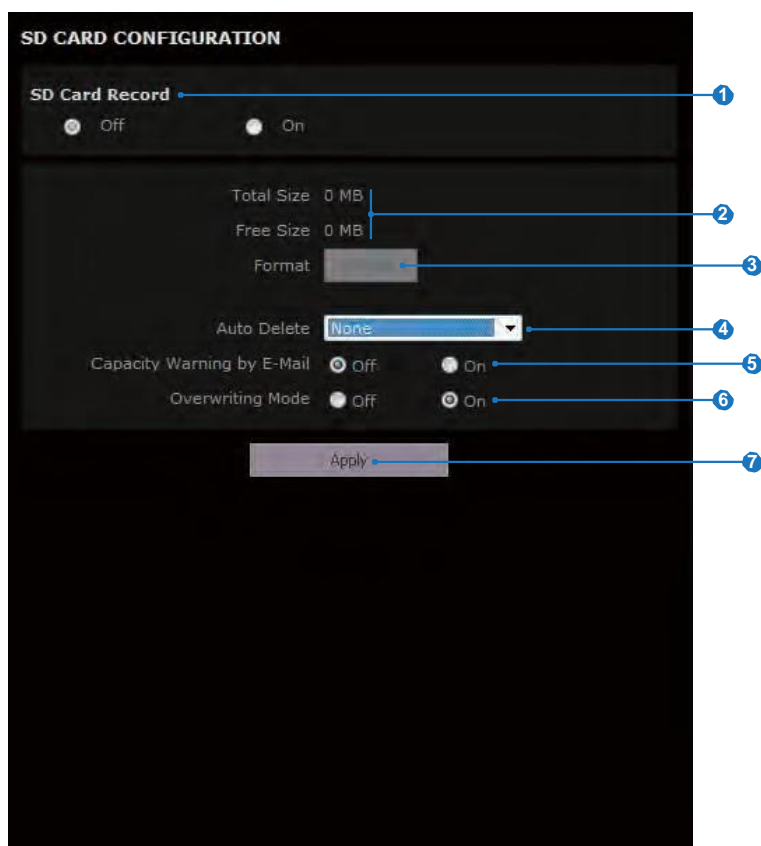

1 SD Card Record

If it is set to On, images will be saved onto the SD card as well.

- ✘ It will setup OFF automatically when SD card does not applied. The SD card setting can be configured on the SD CARD section.

2 Total size / Free size

Display total capacity of SD card and the remainder of it.

3 Format

Delete the all contents that stored in SD card.

- ✘ If the SD card doesn't applied, 'Format' button will be deactivated.

4 Auto Delete

Select the period for Auto delete. The image data stored before set period will be deleted automatically.

NONE	Do not use 'Auto Delete'.
1Week	Delete all stored image older than 1 week from 00:00 today.
1Month	Delete all stored image older than 1 Month from 00:00 today.
1 Year	Delete all stored image older than 1 Year from 00:00 today.

- ✘ This function will be executed everyday to delete data before designated period.

5 Capacity Warning E-mail

If enabled, a warning E-mail will be sent when there is less than 8MB of storage space in the SD card. The E-mail will be sent to the e-mail account set in SMTP menu.

6 Overwriting Mode

If enabled, once available space in the SD card reaches less than 8MB, new data will start to overwrite the oldest data. If it is set OFF and remained space of SD card reaches less than 8MB, image recording will stop.

7 Click 'Apply' to save all changes.

Setup - Users Setup

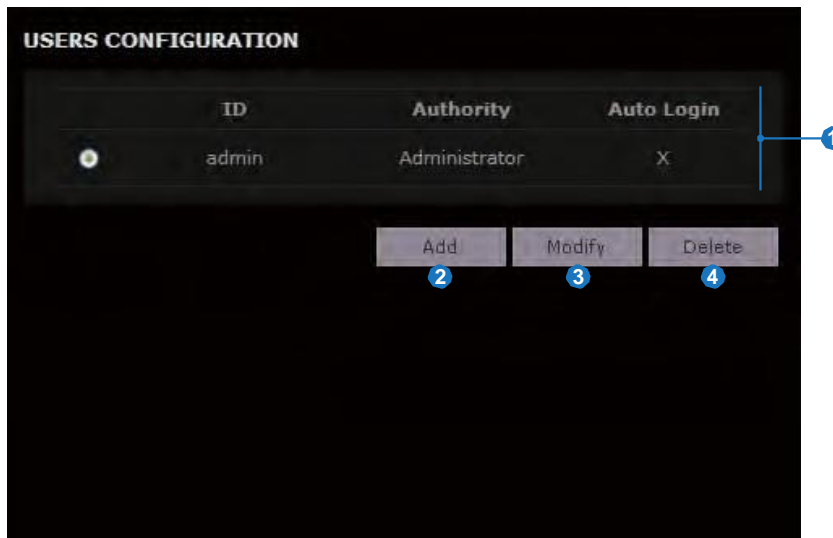

1 Users

List all the user accounts for authentication.

2 Add

Register a new user

ID	Enter a new user ID except Admin since it exists.
Password	Enter the user Password.
Verify	Enter the user Password again for verification.
User Level	Select Operator or Viewer. <ul style="list-style-type: none"> • Viewer : Only monitoring is allowed. • Operator : Most of the functions are allowed except 'Setup'. • Administrator: All functions are allowed.
Auto Login	If you check the auto login for an account, this account becomes the public account. From the next login, everybody can access the camera using this account without authentication. Only one account can have the Auto Login.

⊠ The ID and Password are limited to 10 characters.

3 Modify

Modify the information of an existing user account.

For admin account, only Password and Auto Login function can be modified.

4 Delete

Delete the selected user account. Admin account cannot be deleted.

Setup - SYSTEM CAPABILITY

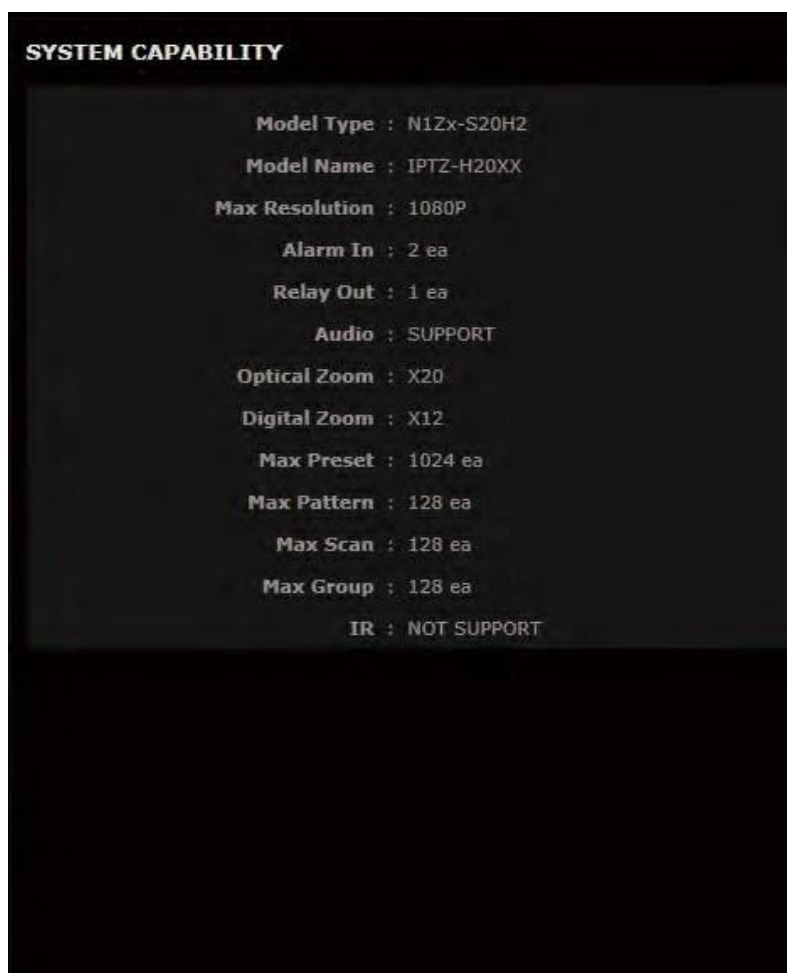

System Capability information.

Setup - Date/Time Setup

The screenshot shows a 'DATE & TIME CONFIGURATION' window with three main sections. Section 1, 'Timezone setup', includes a dropdown menu for 'Timezone' (set to '(GMT) Greenwich Mean Time : Dublin, Edinburgh, Lisbon') and a checkbox for 'Automatically adjust for daylight saving time changes'. Section 2, 'Current Date & Time', displays 'Date: 2000/01/12' and 'Time: 05:14:41'. Section 3, 'New Camera Date & Time', has three radio button options: 'Synchronize with my computer' (selected), 'Setup manually', and 'Synchronize with time server'. The 'Synchronize with my computer' option shows 'Date: 2013/05/20' and 'Time: 16:34:24'. The 'Setup manually' option shows date and time fields with dropdown menus (Date: 2000, 01, 01; Time: 00, 00, 00). The 'Synchronize with time server' option shows a 'Time Server' dropdown (set to 'time-s.nist.gov') and an IP address field (129.6.15.28). Each section has an 'Apply' button at the bottom. Numbered callouts 1 through 6 point to these specific elements.

1 Timezone Setup

Choose Timezone for camera. It will be activated after clicking 'Apply'.

⊗ It is recommended to set the timezone before setting the camera's 'New Camera Date & Time'.

2 Current Date & Time

Shows the current date and time setting in the camera.

3 Synchronize with my computer

Set the date/time using those of PC currently connected.

4 Setup manually

Set the date/time by typing manually.

5 Synchronize with the time server

Choose a time server available to connect to the camera. Date & Time will be updated automatically every hour according to the time server.

6 Click 'Apply' to save all changes.

Setup - Firmware Update

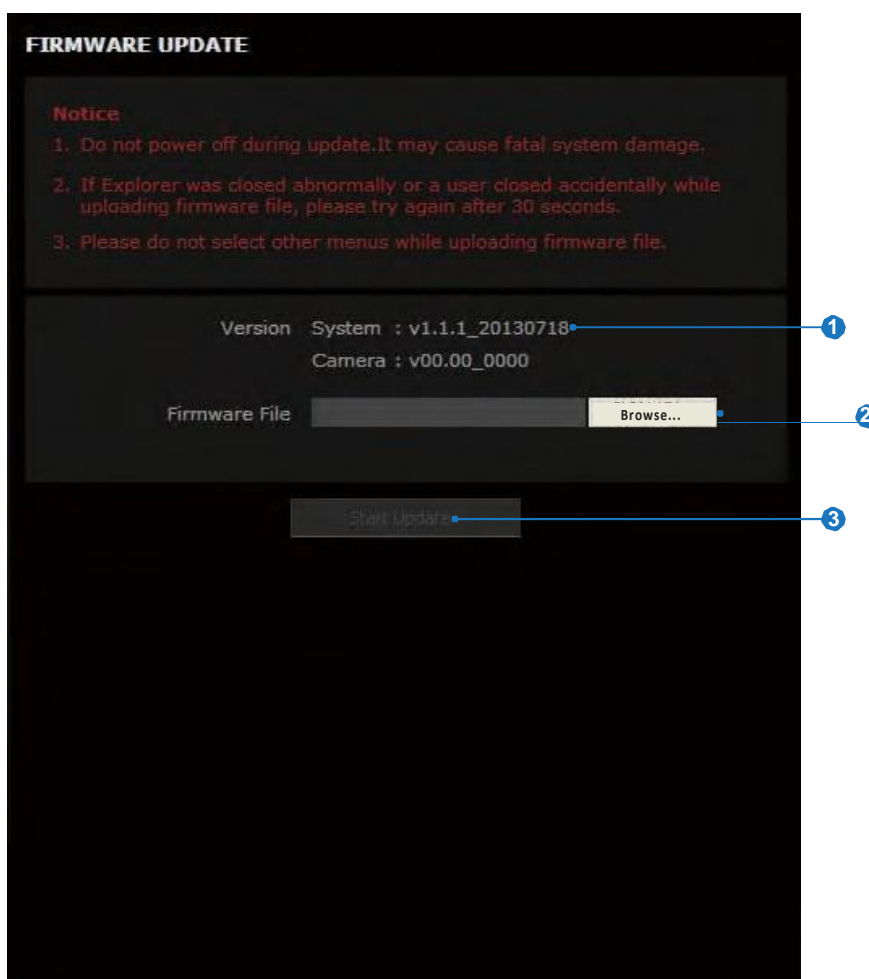

1 Firmware Version

Displays current Firmware Version in the system.

2 Firmware Filename

Designate the Firmware file name in your computer by clicking [Browse...] button.

3 Start Update

Click this button to start update. Progress will be displayed in the Progress Bar. If you assign the wrong file name, an error message will be shown.

⚠ Warning:

1. Do not turn off the power to the camera during Firmware update. The system can be stuck and turn unstable. If updating is completed, the system will reboot automatically.
2. Please make sure to check the 'Notice' shown on screen. If firmware update is completed, the camera will reboot automatically and 'Setup window' will be closed.

Setup - Default Set

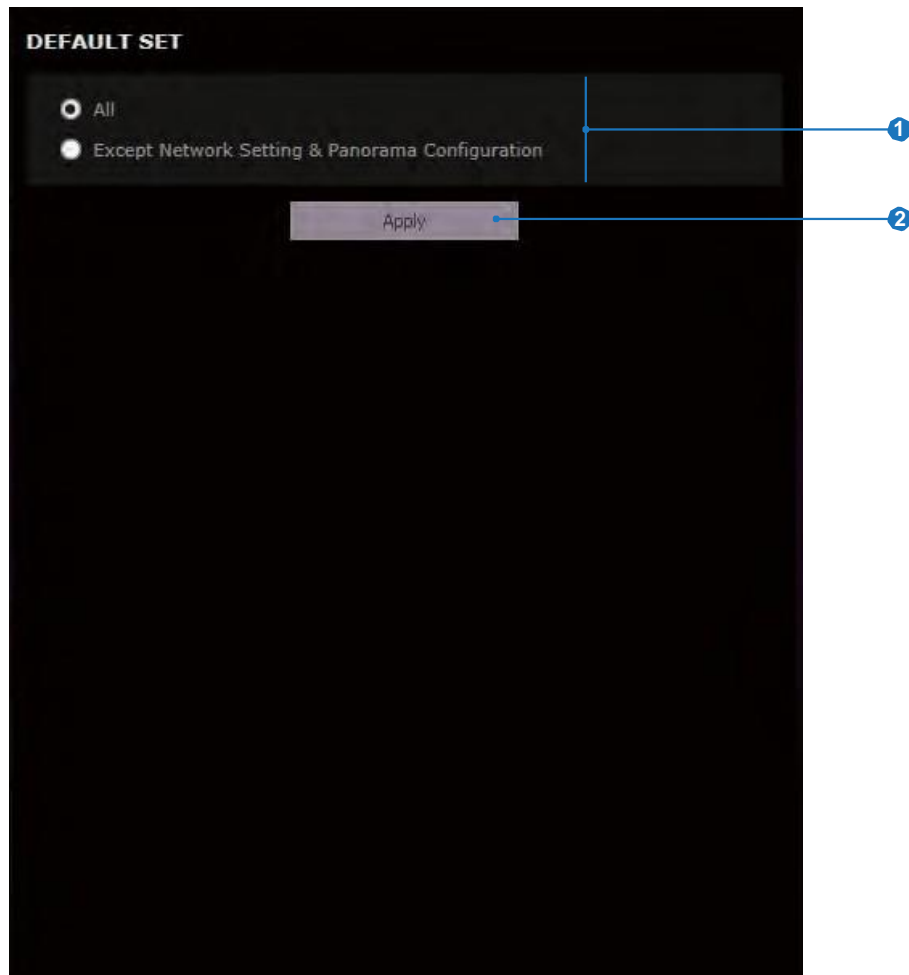

- 1 Reset to the factory defaults**
Return the setup to the factory default.

All	Reset all Settings to the factory defaults.
Except Network Setting & Panorama Configuration	Except Network related settings and Panorama settings, reset all others to the factory default.

- ⚠ Warning:**
If you click 'Apply', you will lose all setting data. If needed, please, make a note for further installation.

- 2** Click 'Apply' to save all changes.
⚠ It takes approximately 4 minutes after clicking 'Apply' for the Default Set.

Setup - Restart



If you click the 'RESTART' menu, a message box will be shown to confirm. Click 'Ok' to restart.

Setup - Log

LOG

← First ← Previous 1 / 11 Next → Last →→

Date & Time	Description
2000/01/01 07:19:53	User login. [192.168.1.100 - admin]
2000/01/01 07:19:53	User login. [192.168.1.100 - admin]
2000/01/01 05:43:28	User login. [192.168.1.100 - admin]
2000/01/01 05:43:28	User login. [192.168.1.100 - admin]
2000/01/01 05:11:05	User login. [192.168.1.100 - admin]
2000/01/01 04:57:10	User login. [192.168.1.100 - admin]
2000/01/01 04:32:40	User login. [192.168.1.100 - admin]
2000/01/01 04:32:40	User login. [192.168.1.100 - admin]
2000/01/01 03:25:26	User login. [192.168.1.1 - admin]
2000/01/01 03:25:21	Network is up. [192.168.1.201]
2000/01/01 03:25:15	Video input.
2000/01/01 03:25:13	No video input. [Start Capture TSK]
2000/01/01 03:24:47	System started.
2000/01/01 02:36:27	User login. [192.168.1.167 - admin]
2000/01/01 02:35:34	Network is up. [192.168.1.201]
2000/01/01 02:33:41	Network is up. [192.168.1.201]
2000/01/01 02:33:34	Video input.

Category System Event

System Start, Network Connection Status (Including IP Address), Changing System Time, Changing Video Setup, Network Setup and Event(Alarm / Motion) Alert will be recorded.

Total 884 pcs logs in each category and the rest will be deleted.

Appendix

A: Current TCP/IP Settings

i If your IP settings are obtained automatically, you could use the MS-DOS prompt (or Command Prompt) to determine your IP address. For information on how to do this, please read the FAQ.

1. Windows 98 / ME Users

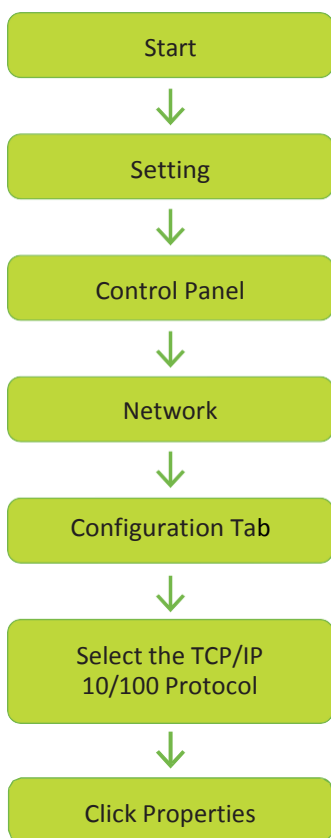

Note the settings under the IP Address, DNS Configuration, and Gateway tabs

2. Windows 2000 or XP Users

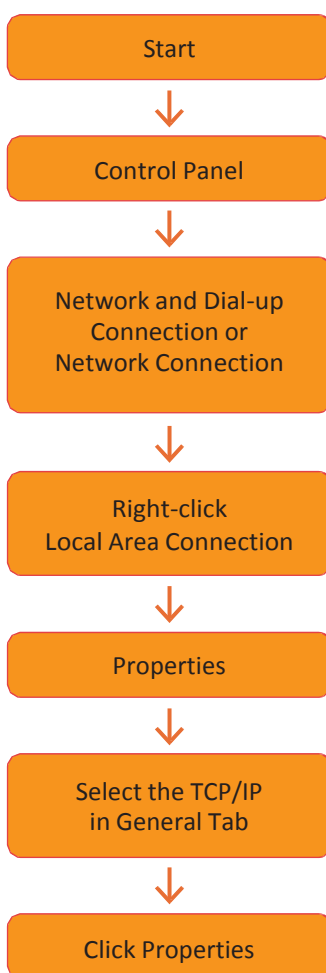

Under the 'General' tab of the TCP/IP Properties you will see your IP address information.

3. Windows Vista or 7 Users

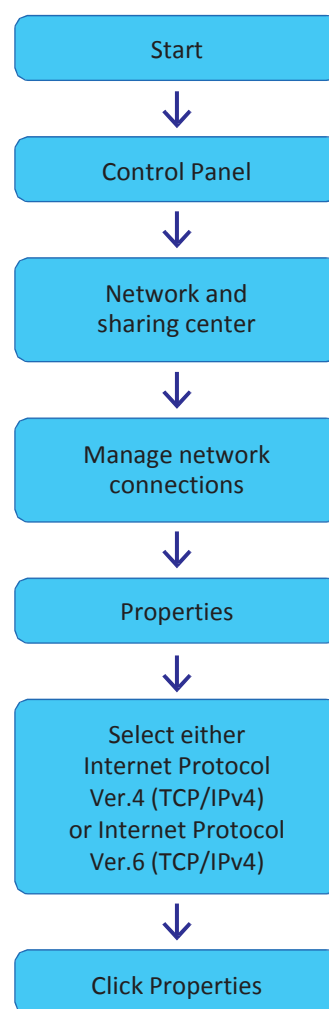

Under the 'General' tab of the TCP/IP Properties you will see your IP address information.

Appendix - B: Changing IP address and subnet mask

1. Windows 98 / ME Users

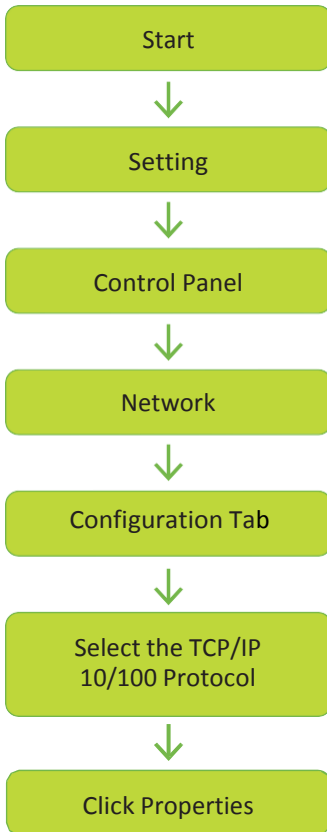

Select 'Use the following IP address' and change the IP address and Subnet Mask.

2. Windows 2000 or XP Users

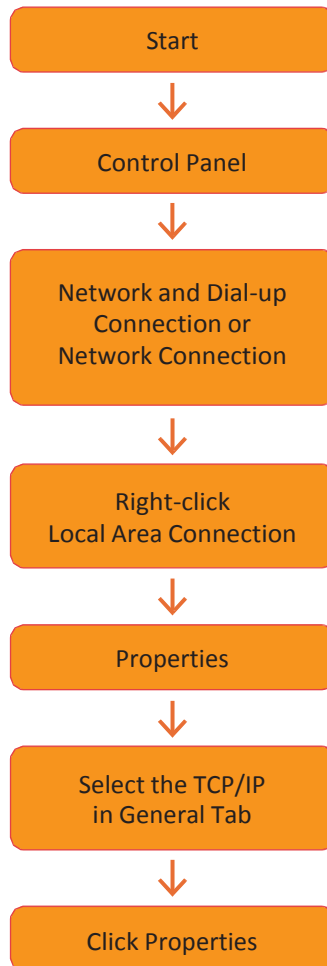

Select 'Use the following IP address'

3. Windows Vista or 7 Users

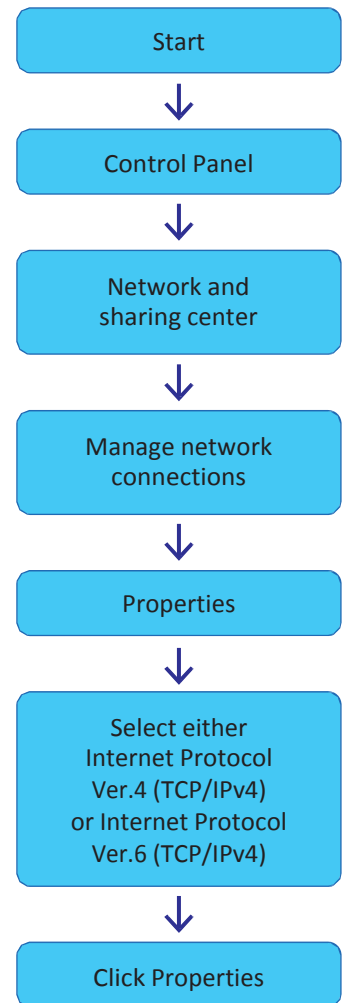

Select 'Use the following IP address'

Appendix - C: Port Forwarding

After assigning the IP Camera a web server port and video server port use Port Forwarding. (for cases A, B)

Consult your router's manual to properly configure Port Forwarding.

For your convenience, we have provided two example configurations.

1. For D-Link DI-604 broadband routers:

- 1) Open a web browser and type http://192.168.0.1
- 2) Enter your User Name and Password to
Default: User Name: admin Password: [leave blank].
- 3) Select the "Advanced" tab and click "Virtual Server".

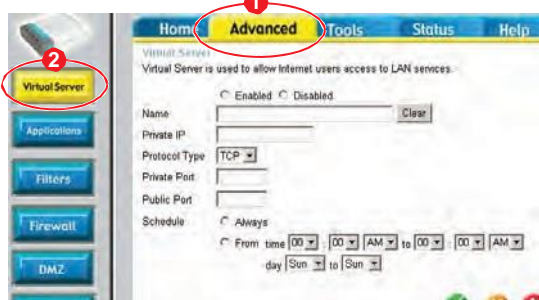

- 4) Click "Apply" after inputting proper values.

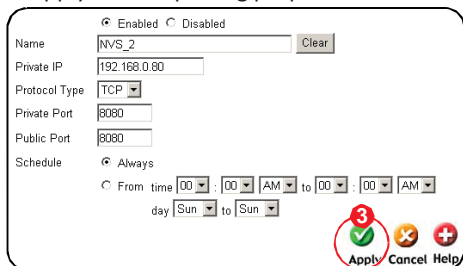

Enabled / Disabled	Select "Enabled".
Name	Input IVS name.
Private IP	Input IVS address.
Protocol Type	Select "TCP".
Private Port / Public Port	Input IVS Web Server Port.
Schedule	Select "Always"

- 5) If 'Setting Saved' shows, click [Continue] button.
- 6) Repeat these steps to add the Video Server Port.
- 7) The Web Server Port, Video Server Port and 2 Audio Ports shows in "Virtual Server List" as below.

Virtual Servers List

Name	Private IP	Protocol	Schedule
<input checked="" type="checkbox"/> NVS_2	192.168.0.80	TCP 8080/8080	always
<input checked="" type="checkbox"/> NVS_2	192.168.0.80	TCP 7777/7777	always
<input checked="" type="checkbox"/> NVS_2	192.168.0.80	TCP 7778/7778	always
<input checked="" type="checkbox"/> NVS_2	192.168.0.80	TCP 7779/7779	always
<input checked="" type="checkbox"/> NVS_2	192.168.0.80	TCP 7780/7780	always

2. For Linksys BEFSR41 Cable/DSL routers:

- 1) Open a web browser and type http://192.168.1.1
- 2) Enter your User Name and Password to
Default: User Name: [leave blank] Password: admin.
- 3) Select "Applications & Gaming" from the menu bar.

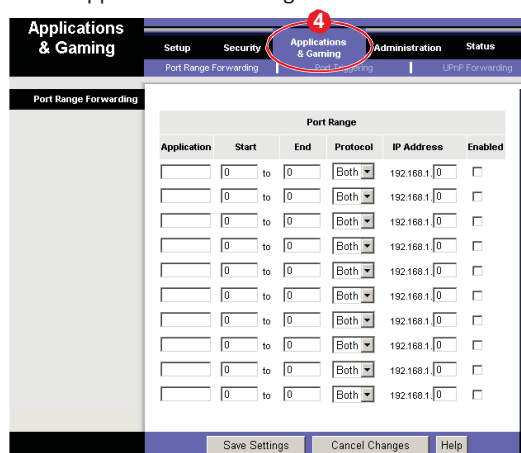

- 4) Input port numbers in "Port Range" as below and click "Save Setting". Both Web Server Port and Video Server Port should be added.

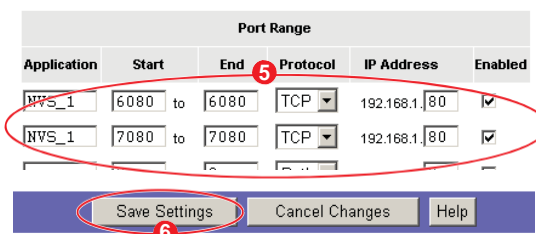

Enabled / Disabled	Input IP Camera name.
Start / End	Input IP Camera Web Server Port and Video Server Port. Start should be same as End. Both of Web Server Port and Video Server Port should be added.
Protocol	Select "TCP" in Protocol option.
IP Address	Input IP Camera IP Address.
Enabled	Check the square.

Appendix - C: Port Forwarding

3. For Netgear RP614 routers:

- 1) Input http://192.168.0.1 in address bar of web browser.
http://192.168.0.1 is the default IP address.
- 2) Input the username and password (admin as ID and password as password).
- 3) Click "Port Forwarding" in "Advanced".
- 4) Click "1 Add Custom Service" in the Port Forwarding page.

Port Forwarding

The screenshot shows the 'Port Forwarding' configuration page. At the top, there is a 'Service Name' dropdown menu set to 'SERVICES' and a 'Server IP Address' field with '192', '168', and '0' entered. Below this is a table with columns: '#', 'Enable', 'Service Name', 'Start Port', 'End Port', and 'Server IP Address'. Under the table, there are three buttons: 'Add Custom Service' (circled in red with a '1'), 'Edit Service', and 'Delete Service'. At the bottom, there are 'Apply' and 'Cancel' buttons.

- 5) Input proper values in "Ports - Custom Services" as below.

Ports - Custom Services

The screenshot shows the 'Ports - Custom Services' configuration page. It has an 'Enable' checkbox which is unchecked. Below it are fields for 'Service Name', 'Starting Port' (with a '(1~65535)' range indicator), 'Ending Port' (with a '(1~65535)' range indicator), and 'Server IP Address' (with '192', '168', and '0' entered). At the bottom, there are 'Add' and 'Cancel' buttons. The 'Add' button is circled in red with a '2' next to it.

Enable	Check the box to activate the entry.
Service Name	Input the IP camera's name.
Starting/ Ending Port	Input the IP camera's Web Server port. Starting Port should be same as Ending Port.
Server IP Address	Input the IP camera's IP Address.

- 6) Click "2 Add".
- 7) With the same method as above, add Video Server Port.
- 8) Click "Apply" to complete Port Forwarding.

Appendix - FAQ

1. My POWER light is not on?

Power is not being supplied to the unit. Please use a proper power supply and verify that a power source is active from the attached power outlet used to connect the adapter. You can test this by plugging in any other electrical device and verify its operation. After making sure the power cable and power supply are working properly, reinsert the power connector into the IP camera. If using a PoE switch, make sure the switch provides the correct amount of power necessary to power the IP camera and that the port is working.

2. My ACTIVE light is not flashing?

Verify the power supply to the unit. Power off the unit and back on again, wait 1 minute, if the ACTIVE light still does not begin to flash, you will have to set the unit to its factory default (THIS WILL DELETE ANY CONFIGURATION SET MANUALLY). Power on the unit and press the reset button for five (5) seconds.

3. My LINK light is not flashing or solid?

Verify the cable connection. Try using a different network cable or crossover cable (for PC connection only).

4. I can access the video server on my LAN, but not from the Internet.

Verify that your router (if applicable) has port forwarding properly configured. If accessing from our DDNS service, verify correct serial number. Check that your Firewall settings are not blocking access to the camera.

5. How do I open an MS-DOS or Command Prompt?

- Windows 98 / ME Users :
Start > Programs > Accessories > MS-DOS prompt
- Windows 2000 / XP Users :
Start > (All) Programs > Accessories > Command Prompt

6. How do I find out my IP address information if my settings were automatically detected?

Windows 98 / ME Users

- 1) Open an MS-DOS Prompt
- 2) At the prompt type: "winipcfg" (without the quotation marks)
- 3) Use the drop down list to select your 10/100 Ethernet Adapter (not a PPP adapter)
- 4) Now you will see your IP Address, Subnet Mask, and Default Gateway information
- 5) For DNS information contact your Internet Service Provider

Windows 2000 / XP Users

- 1) Open a Command Prompt
 - 2) At the prompt type - "ipconfig /all" (without the quotes)
 - 3) Near the end of the information supplied, should be your current IP address, subnet mask, default gateway and DNS servers
-

7. I can't connect!!

In case of a connection failure.

Modem Reboot > Modem Reboot Finished > Router Reboot > Router Reboot Finished > IP Camera Reboot > IP Camera Reboot Finish > Verify DDNS and IP Camera connection, if applicable.

8. How do I "PING" an IP address?

- 1) Open an MS-DOS (or Command) prompt
- 2) At the prompt type - "ping xxx.xxx.xxx.xxx" (without the quotes and replace the "x"s with an IP address)
- 3) Press Enter

9. I'm accessing my video server remotely over the Internet and the video stream is choppy, is this normal?

Yes. The frames per second received remotely are determined by your bandwidth capabilities both at your site where the IP Camera is installed and your remote location. The lower of the two sites will determine how fast your video stream is received. It is recommended to have at least a 256Kb/sec upstream connection from the site where the IP Camera is installed. Lower speeds will operate properly, but provide poor remote performance. The Faster the Internet connection at both ends, the faster the video stream.

10. How do I enable or check ActiveX on my browser

Open Internet Explorer > Tools on the menu bar > Internet Options > Security Tab > Custom Level > Scroll down and verify that you are prompted or have enabled ActiveX controls and plug-ins to be downloaded and executed. > click OK > restart browser.

11. How do I reset the unit to factory defaults?

On the underside of the unit you will find a recessed opening located near the top-left side of the label. Power on the unit and use a paper clip to push the reset button in. The ACTIVE light in the camera module will turn off and after a few seconds the ACTIVE light will begin to flash, signifying a successful reboot. If the ACTIVE light does not turn off after pressing the reset button, please try holding the button in for a few seconds and releasing.

Please note: YOU WILL LOSE ALL DATA THAT HAS BEEN ENTERED PREVIOUSLY AND THE IP CAMERA WILL BE SET TO ITS FACTORY SETTINGS.

Specifications - Dimensions

Unit: mm

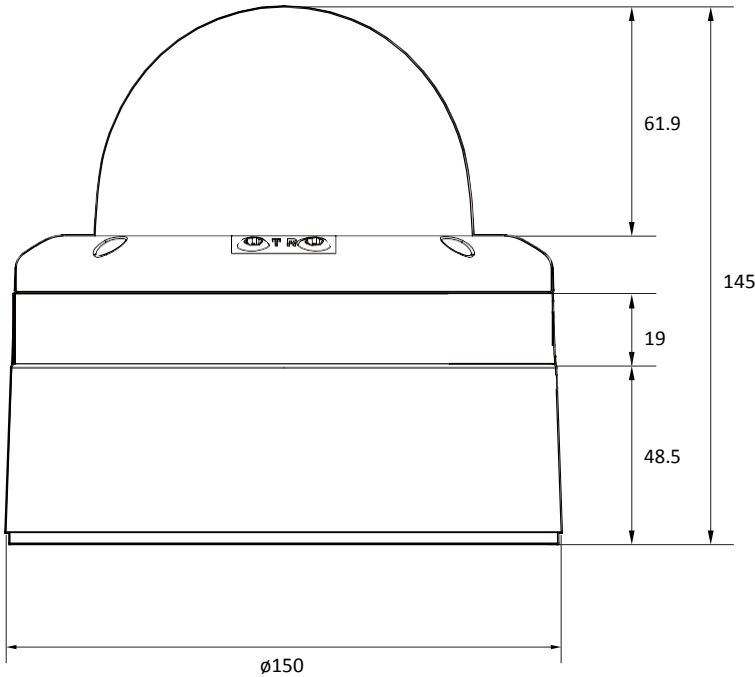
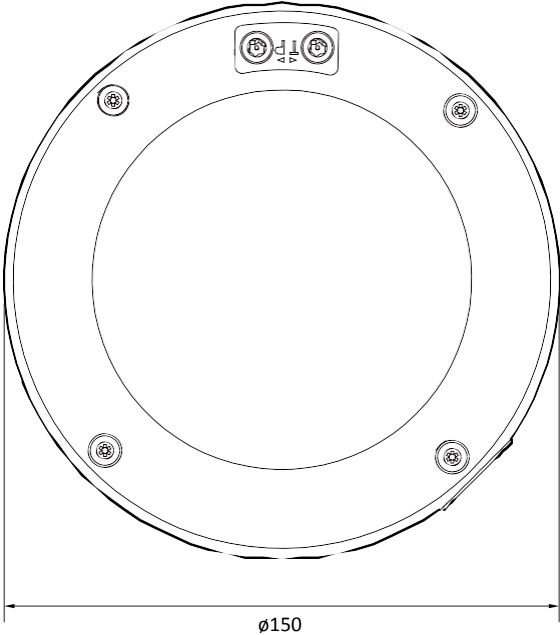



Warranty Information

Digital Watchdog (referred to as “the Warrantor”) warrants the Camera against defects in materials or workmanships as follows:

Labor: For the initial two (2) years from the date of original purchase if the camera is determined to be defective, the Warrantor will repair or replace the unit with new or refurbished product at its option, at no charge.

Parts: In addition, the Warrantor will supply replacement parts for the initial two (2) years.

To obtain warranty or out of warranty service, please contact a technical support representative at 1-866-446-3595 Monday through Friday from 9:00AM to 8:00PM EST.

A purchase receipt or other proof of the date of the original purchase is required before warranty service is rendered. This warranty only covers failures due to defects in materials and workmanship which arise during normal use. This warranty does not cover damages which occurs in shipment or failures which are caused by products not supplied by the Warrantor or failures which result from accident, misuse, abuse, neglect, mishandling, misapplication, alteration, modification, faulty installation, set-up adjustments, improper antenna, inadequate signal pickup, maladjustments of consumer controls, improper operation, power line surge, improper voltage supply, lightning damage, rental use of the product or service by anyone other than an authorized repair facility or damage that is attributable to acts of God.

Limits & Exclusions

There are no express warranties except as listed above. The Warrantor will not be liable for incidental or consequential damages (including, without limitation, damage to recording media) resulting from the use of these products, or arising out of any breach of the warranty. All express and implied warranties, including the warranties of merchantability and fitness for particular purpose, are limited to the applicable warranty period set forth above.

Some states do not allow the exclusion or limitation of incidental or consequential damages or limitations on how long an implied warranty lasts, so the above exclusions or limitations may not apply to you. This warranty gives you specific legal rights, and you may also have other rights from vary from state to state.

If the problem is not handled to your satisfaction, then write to the following address:

Digital Watchdog, Inc.
ATTN: RMA Department
5436 W Crenshaw St
Tampa, FL 33634

Service calls which do not involve defective materials or workmanship as determined by the Warrantor, in its sole discretion, are not covered. Cost of such service calls are the responsibility of the purchaser.



Complete Surveillance Solutions

Headquarters Office: 5436 W Crenshaw St, Tampa, FL 33634

Sales Office: 16220 Bloomfield Ave., Cerritos, California, USA 90703

PH: 866-446-3595 | FAX: 813-888-9262

www.Digital-Watchdog.com

technicalsupport@dwcc.tv

Technical Support PH:

USA & Canada 1+ (866) 446-3595

International 1+ (813) 888-9555

French Canadian 1+ (514) 360-1309

Technical Support Hours: Monday-Friday

9:00am to 8:00pm Eastern Standard Time