

STAR-LIGHT Universal HD over Coax™ Indoor / Outdoor Mini Dome Cameras

DWC-V7253
DWC-V7253TIR



User's Manual Ver. 03/19

Before installing and using the camera, please read this manual carefully.
Be sure to keep it handy for future reference.

 **STAR-LIGHT**[™]
Universal HD Super Low Light Cameras

Index

INTRODUCTION

02	Safety Information
07	Features
08	Part Name
09	Dimension
10	Product & Accessories

INSTALLTION

11	Installation
13	Connecting to Monitors
14	Control Board
15	Adjusting Angle

OSD MENU

16	Menu Tree
17	OSD Menu - Lens
18	OSD Menu - Exposure
20	OSD Menu - Backlight
21	OSD Menu - White Balance
22	OSD Menu - Day&Night
24	OSD Menu - NR
25	OSD Menu - Special
30	OSD Menu - Adjust
31	OSD Menu - Exit

APPENDIX

32	Troubleshooting
33	Specifications
35	Limits & Exclusions
36	Warranty

Safety Information



CAUTION
RISK OF ELECTRIC SHOCK.
DO NOT OPEN



CAUTION:
TO REDUCE THE RISK OF ELECTRIC SHOCK, DO NOT REMOVE COVER (OR BACK) NO USER SERVICEABLE PARTS INSIDE. REFER SERVICING TO QUALIFIED SERVICE PERSONNEL.



This symbol indicates that dangerous voltage consisting of a risk of electric shock is present within this unit.



This exclamation point symbol is intended to alert the user to the presence of important operating and maintenance (servicing) instructions in the literature accompanying the appliance

WARNING

To prevent damage which may result in fire or electric shock hazard, do not expose this appliance to rain or moisture.

WARNING

1. Be sure to use only the standard adapter that is specified in the specification sheet. Using any other adapter could cause fire, electrical shock, or damage to the product
2. Incorrectly connecting the power supply or replacing battery may cause explosion, fire, electric shock, or damage to the product.
3. Do not connect multiple cameras to a single adapter. Exceeding the capacity may cause abnormal heat generation or fire.
4. Securely plug the power cord into the power receptacle. Insecure connection may cause fire.
5. When installing the camera, fasten it securely and firmly. A falling camera may cause personal injury.
6. Do not place conductive objects (e.g. screw drivers, coins, metal things, etc.) or containers filled with water on top of the camera. Doing so may cause personal injury due to fire, electric shock, or falling objects.

Safety Information

7. Do not install the unit in humid, dusty, or sooty locations.
Doing so may cause fire or electric shock.
8. If any unusual smells or smoke come from the unit, stop using the product.
In such case, immediately disconnect the power source and contact the service center.
Continued use in such a condition may cause fire or electric shock.
9. If this product fails to operate normally, contact the nearest service center.
Never disassemble or modify this product in any way.
10. When cleaning, do not spray water directly onto parts of the product.
Doing so may cause fire or electric shock.

PRECAUTION

Operating

- Before using, make sure power supply and all other parts are properly connected.
- While operating, if any abnormal condition or malfunction is observed, stop using the camera immediately and contact your dealer.

Handling

- Do not disassemble or tamper with parts inside the camera.
- Do not drop the camera or subject it to shock or vibration as this can damage the camera.
- Clean the clear dome cover with extra care. Scratches and dust can ruin the quality of the camera image.

Installation and Storage

- Do not install the camera in areas of extreme temperature, exceeding the allowed range.
- Avoid installing in humid or dusty environments.
- Avoid installing in places where radiation is present.
- Avoid installing in places where there are strong magnetic fields and electric signals.
- Avoid installing in places where the camera would be subject to strong vibrations.
- Never expose the camera to rain or water.

Important Safety Instructions

1. Read these instructions.
 - All these safety and operating instructions should be read before the product is installed or operated.
2. Keep these instructions.
 - The safety, operating and use instructions should be retained for future reference.
3. Heed all warnings.
 - All warnings on the product and in the operating instructions should be adhered to.
4. Follow all instructions.
 - All operating and use instructions should be followed.
5. Do not use this device near water.
 - For example: near a bath tub, wash bowl, kitchen sink, laundry tub, in a wet basement; near a swimming pool; etc.
6. Clean only with dry cloth.
 - Unplug this product from the wall outlet before cleaning. Do not use liquid cleaners.
7. Do not block any ventilation openings. Install in accordance with the manufacturer's instructions.
 - Slots and openings in the cabinet are provided for ventilation, to ensure reliable operation of the product, and to protect it from over-heating. The openings should never be blocked by placing the product on bed, sofa, rug or other similar surface. This product should not be placed in a built-in installation such as a bookcase or rack unless proper ventilation is provided and the manufacturer's instructions have been adhered to.
8. Do not install near any heat sources such as radiators, heat registers, or other apparatus (including amplifiers) that produce heat.
9. Do not defeat the safety purpose of the polarized or grounding-type plug. A polarized plug has two blades with one wider than the other. A grounding type plug has two blades and a third grounding prong. The wide blade or the third prong are provided for your safety. If the provided plug does not fit into your outlet, consult an electrician for replacement of the obsolete outlet.
10. Protect the power cord from being walked on or pinched particularly at plugs, convenience receptacles, and the point where they exit from the apparatus.

Important Safety Instructions

11. Only use attachments/accessories specified by the manufacturer.
12. Use only with cart, stand, tripod, bracket, or table specified by the manufacturer, or sold with the apparatus.
When a cart is used, use caution when moving the cart/apparatus combination to avoid injury from tip-over.
13. Unplug this apparatus during lightning storms or when unused for long periods of time.
14. Refer all servicing to qualified service personnel. Servicing is required when the apparatus has been damaged in any way, such as power supply cord or plug is damaged, liquid has been spilled or objects have fallen into the apparatus, the apparatus has been exposed to rain or moisture, does not operate normally, or has been dropped.



Disposal of Old Appliances



1. When this crossed-out wheel bin symbol is attached to a product it means the product is covered by the European Directive 2002/96/EC.
2. All electrical and electronic products should be disposed of separately from the municipal waste stream in accordance to laws designated by the government or the local authorities.
3. The correct disposal of your old appliance will help prevent potential negative consequences for the environment and human health.
4. For more detailed information about disposal of your old appliance, please contact your city office, waste disposal service or the shop where you purchased the product.



This equipment has been tested and found to comply with the limits for a Class A digital device, pursuant to part 15 of the FCC Rules.

These limits are designed to provide reasonable protection against harmful interference when the equipment is operated in a commercial environment.

This equipment generates, uses, and can radiate radio frequency energy and, if not installed and used in accordance with the instruction manual, may cause harmful interference to radio communications.

Operation of this equipment in a residential area is likely to cause harmful interference in which case the user will be required to correct the interference at his own expense.

Features

- Universal HD over Coax™ Technology with HD-Analog, HD-TVI, HD-CVI and all Analog to 960H Signal Support
- STAR-LIGHT™ Super Low Light Technology
- 1/2.7" Image Sensor
- 2.1MP, 1080p Resolution at 30fps
- Fixed Lens 3.6mm
- Digital Wide Dynamic Range (D-WDR)
- OSD Control Via Coaxial (UTC)
- Smart IR™ with Intelligent Camera Sync. 50ft Range (DWC-V7253TIR only)
- Smart DNR™ 3D Digital Noise Reduction
- True Day/Night with Mechanical IR Cut Filter
- De-Fog™ Extreme Weather Image Compensation
- Highlight Masking Exposure (HME)
- Programmable Privacy Zones
- Auto Gain Control (AGC)
- Backlight Compensation (BLC)
- Auto White Balance (AWB)
- IP66 Certified Weather and Tampering Resistant
- IK-10 Impact Rated
- 5 Year Warranty

Part name

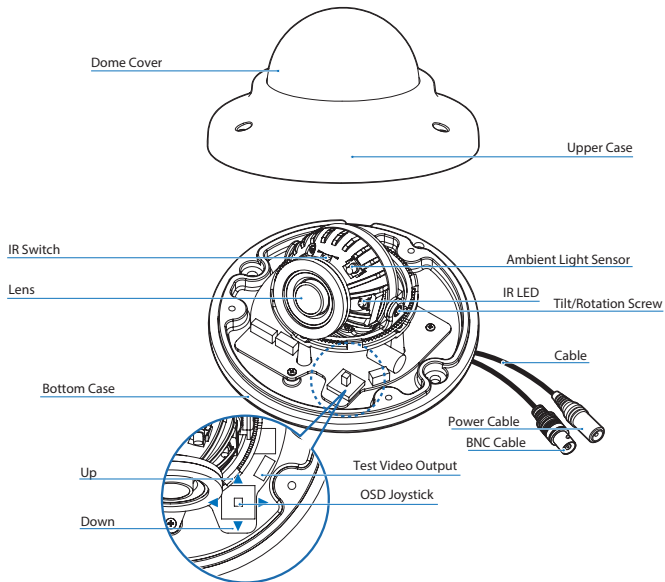

Dimension

Unit : Inches (mm)

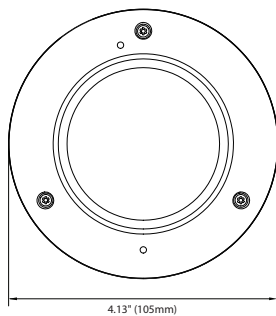
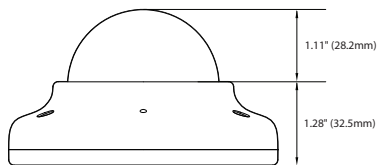

Product & Accessories

☒ Please check if all the camera and accessories are included in the package.

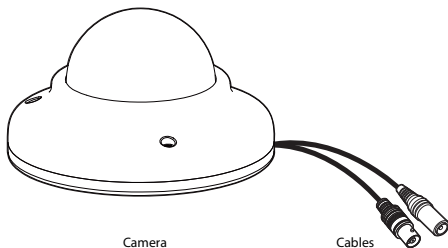

Camera

Cables

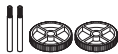

Mount Bolt & Nut



Torx Wrench



Test Video Cable



Template Sheet
for installing by Bolt & Nut



Manual



Screw &
Plastic Anchor-2pcs

☒ **NOTE:** The 'Test Video Cable' is used to test the camera by connecting to a portable display.

Installation- Instructions

- 1 Detach the camera's cover dome from the camera's module by unscrewing the three cover dome screws using the Torx Wrench.
- 2 Use the camera or mounting template to mark and drill the necessary holes in the wall or ceiling.
- 3 Pull wires through and make connections.
- 4 Using three included screws, mount and secure the camera to the wall or ceiling.
- 5 Secure the camera's cover dome onto the camera base and remove the protecting film to complete the installation.

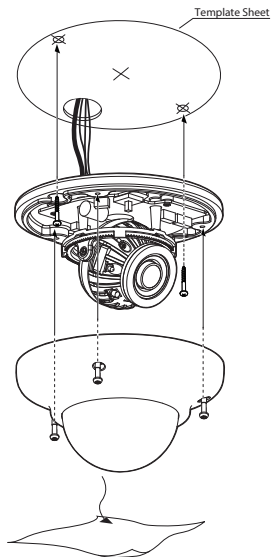

Installation- Using Mount Bolt & Nut

- 1 Detach the camera's cover dome from the camera's module by unscrewing the three cover dome screws.
- 2 Using the camera or mounting template, mark and drill the necessary holes in the wall or ceiling.
- 3 Secure the two long mounting screws to the camera's base.
- 4 Pull wires through and make connections.
- 5 Mount the camera to the mounting surface using the 2 mounting nuts.
- 6 Secure the camera's cover dome onto the camera base to complete the installation.

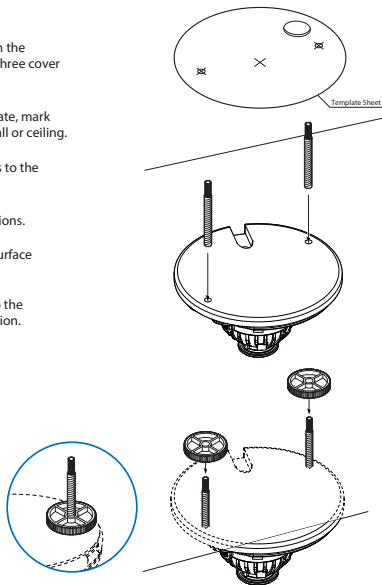

Connecting to DVR/Encoder

Use the diagram below to connect to a Monitor or DVR properly.

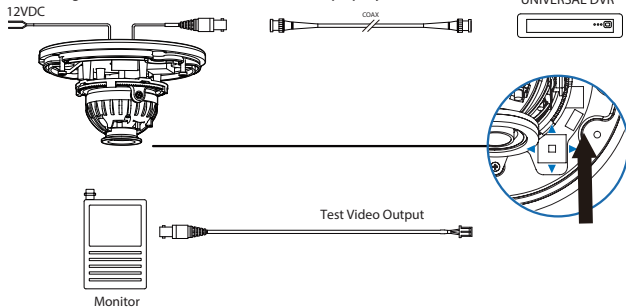

- Power Connection - 12vdc Voltage
- All cameras are equipped with a test video output for on-site configuration.

Control Board

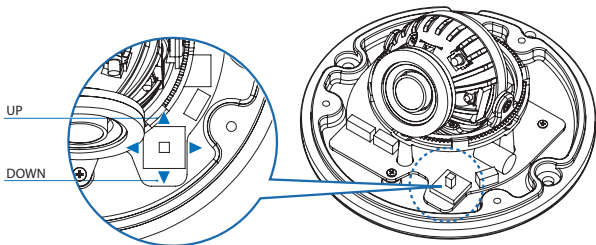

- OSD Joystick : The function setting and video output can be adjusted with OSD joystick. (default : HD-A)

Image Mode

Switches to HD-TVI mode when press OSD Joystick to left 5sec or longer.

Switches to HD-A mode when press OSD Joystick to right 5sec or longer.

Switches to CVBS mode when press OSD Joystick to up 5sec or longer.

Switches to HD-CVI mode when press OSD Joystick to down 5sec or longer.

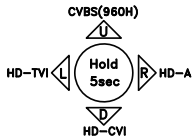

- IR LED Switch : The camera has a manual IR switch, located under the camera's lens. You can use this switch to manually turn the IR LED board on or off according to the installation needs.

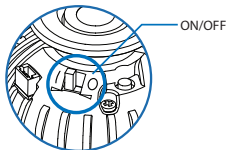

Adjusting the Camera angle

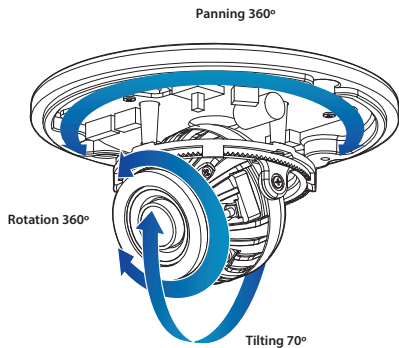

NOTE: to adjust the camera's tilt, loosen the two screws connecting the camera's lens to the base of the camera. Once the camera module has been adjusted to the desired tilting angle, secure the screws back in place.

OSD Menu Tree

- NOTE:** The function setting can be adjusted with both switch (OSD joystick) and remote control through UTC. In case of camera without OSD joystick, it can be adjusted with coaxial (UTC) only.

LENS

P-IRIS	MODE / LIMIT / RETURN
DC	MODE / IRIS SPEED / RETURN
MANUAL	

EXPOSURE

SHUTTER	AUTO / 1/30 ~ 1/50000 / / X2 ~ X30
AGC	0 ~ 15
STARLIGHT	OFF / AUTO (X2 ~ X30)
BRIGHTNESS	1 ~ 100
DRC	OFF / ON(0~8) / AUTO
DEFOG	OFF / AUTO
RETURN	

BACKLIGHT

OFF	
BLC	LEVEL / AREA / DEFAULT / RETURN
HME	SELECT / DISPLAY / BLACK MASK / LEVEL / MODE / DEFAULT / RETURN

WHITE BALANCE

ATW	
PUSH	
MANUAL	BLUE(0~100) / RED(0~100) / RETURN
AWB	

DAY&NIGHT

AUTO	AGC / CDS / EXT LED / RETURN
COLOR	
B/W	BURST / IR SMART / RETURN
EXT	DELAY / EXT LED / NIGHT SW / RETURN

NR(Noise Reduction)

2DNR	OFF / LOW / MIDDLE / HIGH
3DNR	OFF / LOW / MIDDLE / HIGH
RETURN	

SPECIAL

CAM TITLE	OFF / ON
D-EFFECT	FREEZE / MIRROR / NEG. IMAGE / RETURN
MOTION	OFF / ON (SELECT 1~4)
PRIVACY	OFF / ON (SELECT 1~4)
LANGUAGE	ENGLISH/CHINESE 1/CHINESE2/ GERMAN/FRENCH/ITALIAN/ ARABIC/SPANISH/POLISH/ RUSSIAN/PORTUGUESE/DUTCH /TURKISH/KOREAN/JAPANESE/ HEBREW
DEFECT	LIVE DPC / WHITE DPC / BLACK DPC / RETURN
RS485	CAM ID / ID DISPLAY / BAUDRATE / RETURN
RETURN	

ADJUST

SHARPNESS	AUTO / OFF
MONITOR	LCD / CRT
LSC	OFF / ON
VIDEO OUT	NTSC / PAL
RETURN	

EXIT

SAVE & END	
RESET	
NOT SAVE	

OSD Menu_Lens

1 MANUAL

Manual mode supports the fixed board lens or the manual iris lens.

2 P-IRIS

If the camera includes a P-Iris lens, you can select this option to adjust the lens and iris settings.

If P-Iris is selected, adjust the following :

MODE : Select from AUTO or MANUAL. If AUTO is selected, the camera's iris and lens will be adjusted automatically.

LIMIT : If MANUAL is selected, the camera's iris can be adjusted manually using the LIMIT value.

MAIN MENU	
▷LENS	P-IRIS
EXPOSURE	↓
BACKLIGHT	OFF
WHITE_BAL	ATW
DAY&NIGHT	AUTO
NR	↓
SPECIAL	↓
ADJUST	↓
EXIT	SAVE&END

P-IRIS MODE	
▷MODE	AUTO
LIMIT	---
RETURN	RET↓

3 DC

DC lens mode allows you to setup the camera for indoor or outdoor modes.

If DC is selected adjust the following options :

MODE : Select from INDOOR or OUTDOOR.

IRIS SPEED : Set the reaction speed of the camera's Lens iris.

If OUTDOOR mode is selected, you can adjust the minimum and maximum shutter speed. By default, the MIN SHU is set to 1/30. The MAX SHU can be adjusted as needed. The lower the number, the darker the image will appear in bright areas.

MAIN MENU	
▷LENS	DC
EXPOSURE	↓
BACKLIGHT	OFF
WHITE_BAL	ATW
DAY&NIGHT	AUTO
NR	↓
SPECIAL	↓
ADJUST	↓
EXIT	SAVE&END

DC LENS MODE	
▷MODE	INDOOR
IRIS SPEED	---B
RETURN	RET↓

OUTDOOR MODE	
▷MIN SHU	1/30
MAX SHUT	1/60
RETURN	RET↓

OSD Menu_Exposure

1 SHUTTER

Set the camera's shutter speed from available options
(AUTO / 1/30~1/50000 / X2~X30 / FLK)

If Iris is set to AUTO in the lens menu, the camera's shutter will be set automatically and the values in this menu will not be adjustable.
If Iris is set to AUTO in the lens menu, the camera's shutter speed will be deactivated.

2 AGC (Auto Gain Control)

0 ~ 15

AGC enhances the picture brightness in low light conditions.
A higher level AGC setting makes the images brighter ;
however, it could increase the amount of noise.

3 STARLIGHT

OFF / AUTO (X2~X30)

Automatically activates slow shutter function when the image is too dark. High values are not recommended as they may cause the image to lag. To adjust the STARLIGHT values, select AUTO and enter the sub-menu. Starlight menu cannot be controlled if the SHUTTER setting is above 1/60. If AGC is set to 0, the STARLIGHT menu will be inactive.

4 BRIGHTNESS

1 ~ 100

Adjust the camera's brightness from 1~100.
The higher the number, the brighter the image will appear.

EXPOSURE	
▷SHUTTER	1/30
AGC	--- 12
STARLIGHT	AUTO ↓
BRIGHTNESS	--- 45
DRC	OFF
DEFOG	OFF
RETURN	RET ↓

OSD Menu_Exposure(CONT.)

5 DRC (Dynamic Range Compressor)

DRC enables dark areas in images to become more visible without overexposing the bright areas to create one perfect image. Select from : OFF / ON / AUTO. If ON is selected, adjust the DRC value from 0~8.

6 DEFOG

Allows the camera to process a scene that is obscured by fog or weather conditions and provides a visibly improved image.

- POS/SIZE : Set the location and size of the defog mask. Use the joystick controller on the camea's board to adjust the De-Fog zone's position. Press the enter key and use the joystick controller to adjust the zone's size.

- GRADATION : Set the DEFOG level from 0~2. The higher the number, the stronger the Defog mask will be.

- DEFAULT : Return the Defog settings to their default values.

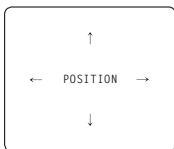
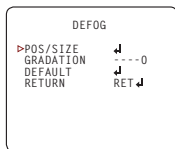

OSD Menu_Backlight

1 BLC (Back Light Compensation)

If BLC is selected, adjust the size and position of the mask :

- Level : Set the BLC Levels LOW/MIDDLE/HIGH
- AREA : Use the joystick controller on the camera's board to adjust the zone's position.
Press the enter key and use the joystick controller to adjust the zone's size.
- DEFAULT : Return the BLC settings to their original default values.

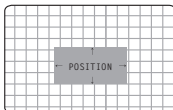
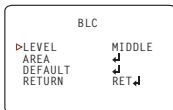
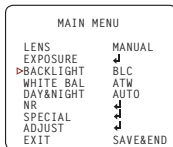

2 HME (Highlight Masking Exposure)

HME allows objects to appear clearly on the screen by masking extremely bright areas.

- SELECT : The camera supports up to four different HME zones.
Select which zone to setup.
- DISPLAY : For the selected zone, select ON to adjust its position and size. Use the joystick controller on the camera's board to adjust the zone's position. Press the enter key and use the joystick controller to adjust the zone's size.
- BLACK MASK : Select whether the HME mask will display in black on the camera's view.
- LEVEL : Set the working range of the HME. The higher the value, the HME mask will appear only around bright sources. Set the value from 0~100. Default value is 20.
- MODE : Select whether the HME mask will appear during night mode only or all day. If the zone is set to night mode, the zone will appear based on the AGC setting value.
- DEFAULT : Return the settings to their original default values.

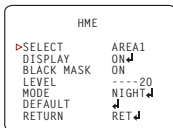

OSD Menu_White Balance

1 ATW

Auto Tracking White Balance Control mode compensates for color temperature changes between 2400K° and 11000K°.

2 PUSH

Push fixes the white balance based on the current lighting automatically. To use this function, press the ENTER key for five sec.

3 MANUAL

Control the white balance manually by changing RED and BLUE.

RED : Adjusts the low color temperature in the image between 0~100. The default value is 44.

BLUE : Adjusts the low color temperature in the image between 0~100. The default value is 44.

4 AWB

Auto White Balance Control mode compensates for color temperature changes lower than 2500K° and higher than 12000K°.

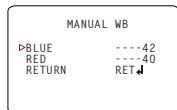
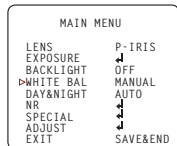
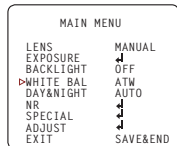

OSD Menu_Day & Night

- AUTO : Day/Night switch is based on the CDS levels (IR models) or AGC levels (non-IR models).
- COLOR : The camera always stays in day/color mode.
- B&W : The camera always stays in night/B&W mode.
- EXT : The camera's Day & Night settings are set according to an external IR LED board.

1 AUTO

For cameras with no IR LED Built-in :

- D→N Threshold (AGC) : Set when the camera switches from day to night mode by the AGC value.
When the camera detects AGC levels beyond the set threshold, it will switch from color to B/W.
- D→N Delay (AGC) : Set a delay for the camera when switching from day to night mode.
- N→D Threshold (AGC) : Set when the camera switches from night to day mode by the AGC value.
When the camera detects AGC levels beyond the set threshold, it will switch from B/W to color.
- N→D Delay (AGC) : Set a delay for the camera when switching from night to day mode.

For cameras with IR LED Built-in :

- D→N Threshold (CDS) : Set when the camera switches from day to night mode.
The lower the value, the camera will require less light (more darkness) to switch to Night Mode.
- D→N Delay (CDS) : Set a delay for the camera when switching from day to night mode.
- N→D Threshold (CDS) : Set when the camera switches from night to day mode.
The lower the value, the camera will require less light (more darkness) to switch to Night Mode.
- N→D Delay (CDS) : Set a delay for the camera when switching from night to day mode.
- EXT LED : AUTO : The LEDs are enabled/disabled by the CDS Sensor on the LED Board.
OFF : The camera's LEDs are disabled manually.

OSD Menu_Day & Night (CONT.)

2 COLOR

If COLOR mode is selected, the camera's display will always appear in color, regardless of the lighting condition.

3 B/W

- BURST : Select to enable or disable color burst when the camera switches from color to B/W.
- IR SMART (0~15) : Enable Smart IR and set the level. Higher values will make SMART IR stronger.

4 EXT

The Day & Night settings are set according to a CDS sensor in an external IR LED board.

- D→N Delay : Set a delay for the camera when switching from day to night mode.
- N→D Delay : Set a delay for the camera when switching from day to night mode.
- EXT LED : Auto : The LEDs are enabled/disabled by the CDS Sensor on the LED Board.
OFF : The camera's LEDs are disabled manually.
- NIGHT S/W : Based on the CDS settings in the external LED board, set the value for LOW/HIGH.

OSD Menu_NR

1 NR (Noise Reduction)

NR reduces the noise on the screen in low light conditions and allows for clearer images, even at night.

2DNR : Set the Digital Noise Reduction values for general illumination. Select from LOW/MIDDLE/HIGH. If the 2DNR settings are set to HIGH, image sharpness may be affected.

3DNR : Set the Digital Noise Reduction values for very low light situations. Select from LOW/MIDDLE/HIGH. If the 3DNR settings are set to HIGH, lagging issues may appear when motion occurs.

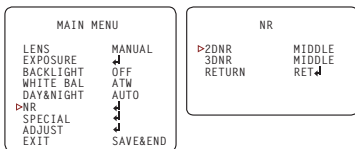

OSD Menu_Special

1 CAM. TITLE

Add a name to the camera. Set the title by using the OSD joystick.

2 D-EFFECT

FREEZE Freeze image from the camera at the selected moment.

MIRROR Reflects the camera : OFF / MIRROR / V-FLIP / ROTATE

NEG. IMAGE Display the camera's view in negative colors.



3 MOTION

- **SELECT** : The camera supports up to 4 separate motion detection areas. Select which one to adjust.
- **DISPLAY** : For the selected zone, select ON to adjust its position and size. Use the joystick controller on the camera's board to adjust the zone's position. Press the enter key and use the joystick controller to adjust the zone's size.
- **SENSITIVITY** : Set the camera's sensitivity to motion. The higher the value, the more sensitive the camera is to motion.
- **COLOR** : Set the color for the motion zone. Select from green, blue, white, or red.
- **TRANS** : Set the zone's transparency. The lower the number, the more transparent the zone will appear on the camera's display.

OSD Menu_Special (CONT.)

4 MOTION

- ALARM :

VIEW TYPE : When motion is detected, select from the following display options :

1. OFF - Do not display motion alarm
2. ALL - Show all motion zones when motion alarm is detected.
3. BLOCK - Show the area where motion is detected as a solid block.
4. OUTLINE - Show the area where motion is detected as an outline only.

OSD VIEW : If enabled, ALARM will appear on the screen when motion is detected.

ALARM OUT : The camera supports 3.3V alarm output. When motion is detected, an alarm output can be triggered if enabled.

TIME : Set the dwell time after motion is detected. Values are in seconds.

- DEFAULT : Reset the motion detection settings to their default values.

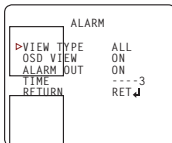
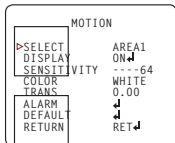

OSD Menu_Special (CONT.)

5 PRIVACY

- SELECT : The camera supports up to 4 separate privacy zones. Select which one to adjust.
- DISPLAY : There are three types of privacy masks you can apply. Select from OFF, MOSAIC, INV., or COLOR
 1. MOSAIC - The privacy mask will appear as a mosaic over the camera's image.
 2. INV. - The privacy mask will appear as a negative of the image behind it, reversing the colors and brightness.
 3. COLOR - The privacy mask will appear as a block of color according to the settings in the COLOR menu.

To adjust the zone's position and size, once the type of mask is selected, use the joystick controller on the camera's board to adjust the zone's position. Press the enter key and use the joystick controller to adjust the zone's size.

- COLOR : If COLOR is selected under the display options, set the color for the motion zone. Select from white, black, red, blue, yellow, green, cyan, or user. If user is selected, the mask's color will default to dark green.
- TRANS : Set the zone's transparency. The lower the number, the more transparent the zone will be.
- DEFAULT : Reset the motion detection settings to their default values.

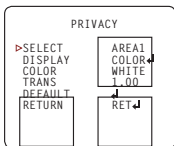
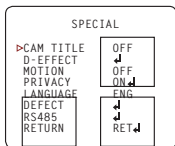

OSD Menu_Special (CONT.)

6 LANGUAGE

Select from the available options : English, Chines 1, Chinese 2, German, French, Italian, Spanish, Polish, Russian, Portuguese, Dutch, Turkish, Korean, Japanese, Arabic, or Hebrew.

7 DEFECT

- LIVE DPC :

1. AGC LEVEL - Set the AGC levels for the Live DPC.
2. LEVEL - Set the level of Live DPC based on the AGC levels.

- WHITE DPC :

1. POS/SIZE - Set the DPC Zone. Use the joystick's controller on the camera's board to adjust the zone's position. Press the enter key and use the joystick controller to adjust the zone's size.
2. START - Press START to begin the DPC test. The screen will get bright and compensate for the black defect.
3. DPC VIEW - Show the Defect pixels which have been compensated.
4. LEVEL - Set the range of DPC application.
5. AGC - Set the value level for AGC while DPC is on.
6. SENS-UP - Sent the value level of Sens-Up while DPC is on.

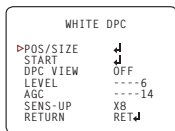
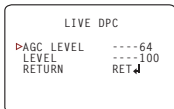
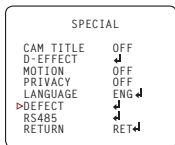

OSD Menu_Special (CONT.)

8 DEFECT (CONT.)

- BLACK DPC :

1. POS/SIZE : Set the size and position for the DPC Zone.

Use the joystick controller on the camera's board to adjust the zone's position. Press the enter key and use the joystick controller to adjust the zone's size.

2. START : Press START to begin the DPC test. The screen will get bright and compensate for the black defect.
3. DPC VIEW : Show the Defect pixels which have been compensated.
4. LEVEL : Set the range of DPC application.

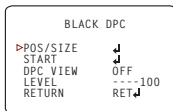

9 RS485

- CAM ID : Set the camera's ID from 0~255.

- ID DISPLAY : Select to show or hide the camera ID on the screen.

- BAUDRATE : Set the camera's baudrate.

Select from : 2400/4800/9600/19200/38400. Default is 9600.

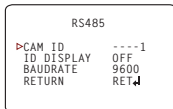

OSD Menu_Adjust

1 SHARPNESS

Set the sharpness of the image. The Sharpness values can be increased or lowered according to the AGC levels in the camera's view. If AUTO is selected, adjust the following values :

- LEVEL : Set the sharpness level. The higher the number, the sharper the image will appear.
- START AGC : Select the AGC value where the image's sharp lines may start to appear smeared in low light.
- END AGC : Select end AGC value for sharpness smearing in low light. Once the AGC values pass the set END AGC, the image's sharp lines will no longer appear smeared if the environment gets darker.

2 MONITOR

Adjust the camera's signal according to the monitor you are using.

- LCD Mode : If using and LCD monitor, adjust the following settings:

1. GAMMA - Set the gamma level from 0.45~1.00 / USER
0.55 is default setting.
 2. BLUE GAIN - Set the blue levels from 0~100.
 3. RED GAIN - Set the red levels from 0~100.
- CRT ode : If using an CRT monitor, adjust the following settings :
1. BLUE GAIN - Set the blue levels from 0~100.
 2. RED GAIN - Set the red levels from 0~100.

3 LSC (Lens Side Compensation)

The LSC function improves the brightness around the lens.

4 VIDEO OUT

If you need to change the camera's video output, select from NTSC or PAL.
Reboot the camera after making any changes to the video signal settings.

LCD	
P>GAMMA	0.55
BLUE GAIN	---64
RED GAIN	---64
RETURN	RET↓

CRT	
P>BLUE GAIN	---64
RED GAIN	---64
RETURN	RET↓

OSD Menu_EXIT

1 SAVE & END

Save all changes made to the camera's settings and exit the OSD menu.

2 RESET

The camera's settings will be reset to their factory default values once you exit the OSD menu.

3 NOT SAVE

Exit the OSD menu without saving any changes made to the camera's settings.

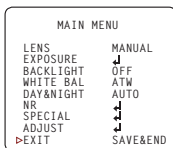

Troubleshooting

Before sending your camera for repair, check the following or contact our technical specialist.

FOR NO VIDEO

Check the coaxial cable and make sure it is connected securely.

Check the power supply and make sure the camera has the proper voltage and current.

FOR OUT-OF-FOCUS VIDEO

Check the clear dome cover and the lens for dirt or fingerprints. Use a soft cloth and gently clean.

The use of a field test monitor is recommended.

Specifications

VIDEO	
Image Sensor	1/2.7" CMOS Sensors
Active Pixels	1920(H) x 1080(V)
Scanning System	Progressive scan
Frequency	60Hz / 50Hz
Signal Technology	2.0 Megapixel Universal
Synchronization	Internal
Resolution	1920x1080 (1080p30fps)
Minimum Scene Illumination	F2.0 (30IRE): 0.41 Lux (Color) F1.4 (30IRE): 0 Lux (B&W)
S/N Ratio	55dB
Video Output	BNC (Universal : HD-A/HD-TVI/HD-CVI/CVBS)
LENS	
Focal Length & Lens Type	3.6mm (F2.0)fixed
IR Distance	50ft
OPERATIONAL	
Shutter Speed	AUTO / 1/30~1/50,000 / X2~X30 / FLK
Backlight	OFF/BLC/HME
Starlight	OFF, x2 - x30

Specifications

OPERATIONAL (CONT.)	
Digital Noise Reduction	OFF / LOW / MIDDLE / HIGH
White Balance	ATW / PUSH / MANUAL / AWB
Day and Night	AUTO / COLOR / BW / EXT
Auto Gain Control	0 ~ 15
Motion Detection	ON/OFF (4 Zones)
Privacy Zones	ON/OFF (4 Zones)
Sharpness	0 ~ 10
Gamma	0.45 ~ 1.00 / USER
Remote Control	Coaxial(UTC)
ENVIRONMENTAL	
Operating Temperature	-4°F ~ 122°F (-20°C ~ 50°C)
Operating Humidity	No more than 90% (Non-Condensing)
IP Rating	IP66
Other Certifications	FCC, CE, ROHS
ELECTRICAL	
Power Requirements	DC12V
Power Consumption	LED OFF : 1.92W, 160mA LED ON : 3.12W, 260mA
MECHANICAL	
Housing Material and Dimensions	Aluminum, 4.13 x 2.38 in (105 x 60.7mm)
Weight	0.77 lbs

Limits & Exclusions

There are no express warranties except as listed. The warrantor will not be liable for incidental or consequential damages (including damage to recording media without limitation) resulting from the use of these products or arising out of any breach of the warranty. All express and implied warranties, including the warranties of merchantability and fitness for particular purpose, are limited to the applicable warranty period set forth above.

Some states do not allow the exclusion or limitation of incidental or consequential damages, or limitations on how long an implied warranty lasts, so the exclusions or limitations listed above may not apply to you. This warranty gives you specific legal rights, and you may also have other rights that vary from state-to-state.

If the problem is not handled to your satisfaction, then write to the following address:

Digital Watchdog, Inc.
ATTN: RMA Department
5436 W. Crenshaw Street
Tampa, FL 33634

Service calls which do not involve defective materials or workmanship as determined by the Warrantor, in its sole discretion, are not covered. Costs of such service calls are the responsibility of the purchaser.

Warranty Information

Digital Watchdog (referred to as “the Warranter”) warrants the Digital Watchdog Camera against defects in materials or workmanship as follows:

LABOR: For the initial five (5) years and one (1) year on IR LED from the original purchase date, if the camera is determined to be defective, the Warranter will repair or replace the unit with a new or refurbished product at its option at no charge.

PARTS: In addition, the Warranter will supply replacement parts for the initial five (5) years and one (1) year on IR LED.

To obtain warranty or out of warranty service, please contact a Technical Support Representative at 1+ (866)446-3595 Monday through Friday from 9:00AM to 8:00PM Eastern Standard Time.

A purchase receipt or other proof of the original purchase date is required before warranty service is rendered. This warranty only covers failures due to defects in materials and workmanship which arise during normal use. This warranty does not cover damage which occurs in shipment or failures which are caused by products not supplied by the Warranter or failures which result from accident, misuse, abuse, neglect, mishandling, misapplication, alteration, modification, faulty installation, set-up adjustments, improper antenna, inadequate signal pickup, maladjustment of consumer controls, improper operation, power line surge, improper voltage supply, lightning damage, rental use of the product or service by anyone other than an authorized repair facility or damage that is attributable to acts of God.

Notes

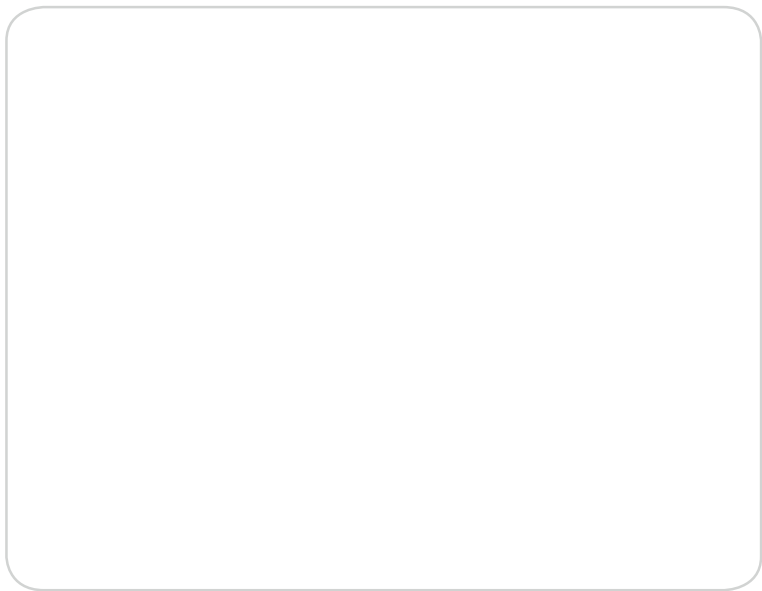

Notes

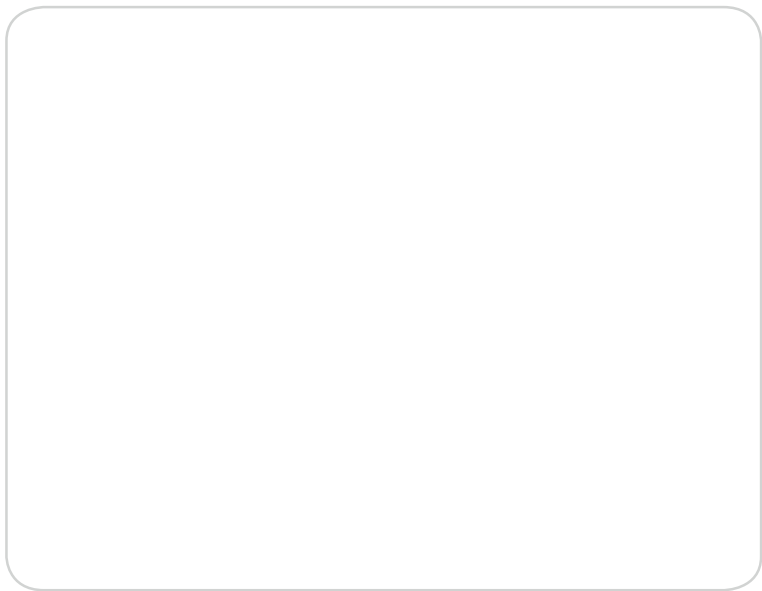

Notes

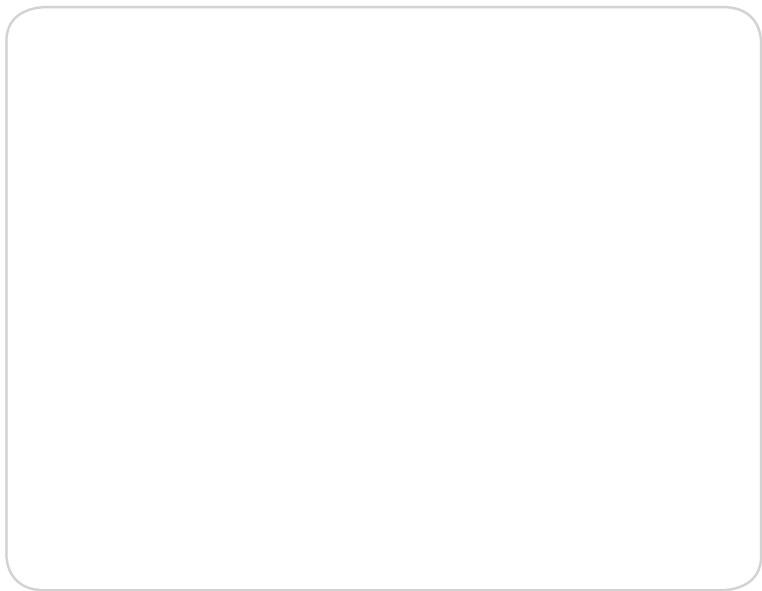
A large, empty rounded rectangular box with a thin gray border, intended for taking notes. The box is centered on the page and occupies most of the vertical space below the 'Notes' header.



Complete Surveillance Solutions

East Coast Headquarters Office: 5436 W Crenshaw St, Tampa, FL 33634

West Coast Headquarters Office: 16220 Bloomfield Ave., Cerritos, CA 90703

PH: 866-446-35951 FAX: 813-888-9262

www.Digital-Watchdog.com Technical Support:

USA & Canada 1+ (866) 446-3595

International 1+ (813) 888-9555

French Canadian 1+ (514) 360-1309

Support Hours: Monday-Friday 9:00am to 8:00pm EST