

## GV-AVD2700 2MP H.265 Low Lux WDR Pro IR Vandal Proof IP Dome



- 1/2.8" progressive scan low lux CMOS
- Min. illumination at 0.001 lux
- Triple streams from H.265, H.264 and MJPEG
- Up to 30 fps at 1920 x 1080
- Intelligent IR
- IR distance up to 30 m (100 ft)
- Day and Night function (with removable IR-cut filter)
- Vandal resistance (IK10 for metal casing)
- Ingress protection (IP67)
- 3-axis mechanism (pan / tilt / rotate)
- Built-in micro SD card slot (SD / SDHC / SDXC / UHS-I, Class 10) for local storage
- Two-way audio
- DC 12V / PoE (IEEE 802.3af)
- Wide Dynamic Range Pro (WDR Pro)
- Defog
- 3D noise reduction
- Motion detection
- Tampering Alarm
- Text overlay
- Privacy mask
- ONVIF (Profile G, S, T) conformant

### Introduction

The Vandal Proof IP Dome is an outdoor camera designed with IK10 vandal resistance and IP67 ingress protection. GV-AVD2700 supports H.265 video codec to achieve better compression ratio while maintaining high quality pictures at reduced network bandwidths. The camera is equipped with an automatic IR-cut filter and IR LEDs for day and night surveillance. With Wide Dynamic Pro (WDR Pro), it can process scenes with contrasting intensities of light and produce clear image. Adjustable in 3 axis (pan, tilt and rotate), it offers an entry-level surveillance solution with all the essential features and excellent image quality.

### Active Tampering Alarm

Tampered



Focus Change



Camera Shift

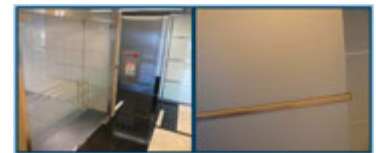

## Dimensions

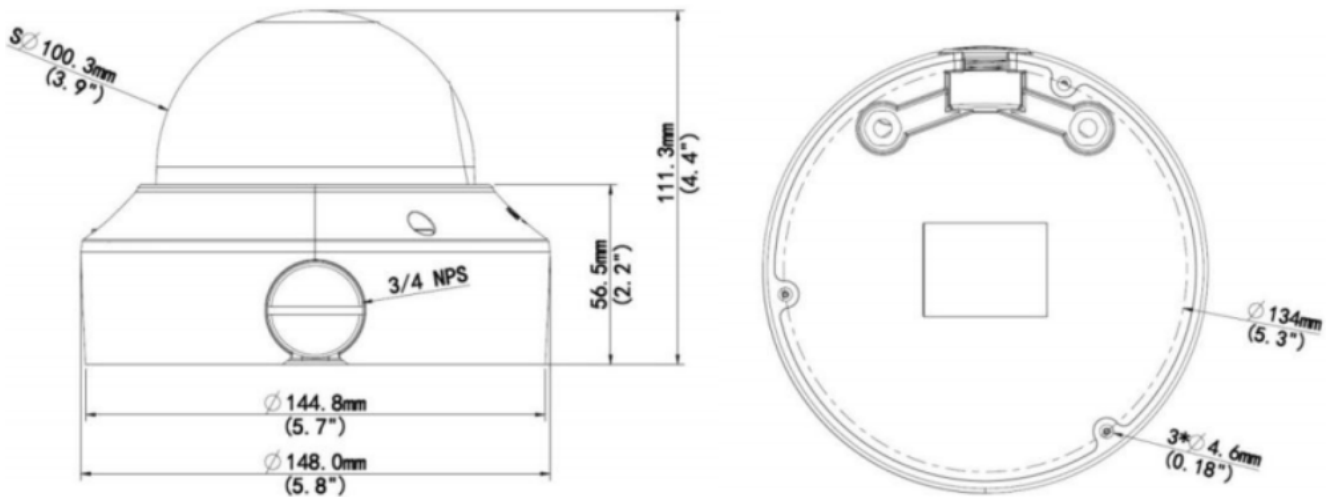

## Specifications

Camera		
Image Sensor		1/2.8" progressive scan low lux CMOS
Picture Elements		1920 (H) x 1080 (V)
Minimum Illumination	Color	0.001 Lux (F1.6, AGC ON)
	IR On	0 Lux
Shutter Speed		Auto, Manual (1/6 ~ 1/100000 sec)
White Balance		Auto, Manual
Gain Control		Auto, Manual
S/N Ratio		52 dB
WDR Pro		Yes
Dynamic Range		Up to 120 dB
Lens		
Megapixel		2 MP
Day/Night		Yes (with removable IR-cut filter)
Focal Length		2.8 ~ 12 mm
Lens Type		Varifocal lens
Maximum Aperture		F/1.6
Mount		$\varnothing 14$ mm
Horizontal FOV		108°~30°
Operation	Focus	Manual (with lock)
	Zoom	Manual (with lock)
	Iris	Fixed
IR LED Quantity		2 IR LEDs
Max. IR Distance		30 m (100 ft)
Operation		
Video Compression		H.265, H.264, MJPEG
Video Streaming		Triple streams
Video Resolution	Main Stream	1920 x 1080 (Default)
	Sub Stream	1280 x 720, 720 x 576, 704 x 288, 640 x 360 (Default), 352 x 288
	Third Stream (Closed by Default)	720 x 576, 704 x 288, 640 x 360, 352 x 288
Frame Rate		30 fps at 1920 x 1080 (60 / 50 Hz) * The frame rate and the performance may vary depending on the number of connections and data bitrates (different scenes).

Video Analytics	Motion Detection, Tampering Alarm, Audio Detection, Cross Line, Intrusion, Object Moving, Object Left, Defocus, Scene Change, Face Detection, People Counting *Tampering Alarm, Audio Detection, Cross Line, Intrusion, Object Moving, Object Left, Defocus, Scene Change, Face Detection and People Counting are only accessible through the camera's Web interface, which can be used to trigger alerts such as e-mail and FTP	
Image Setting	Brightness, Contrast, Saturation, Sharpness, 3D Noise reduction, Image Orientation (Flip, Mirror, 0°, 90°, 180°, 270°-including Corridor format), Exposure Mode, Shutter Speed, Gain Control, Slow Shutter, Backlight Compensation (BLC), Metering Control, D/N Sensitivity, WDR, Smart Illumination, White Balance, Defog	
Audio Compression	G.711	
Audio Support	Two-way Audio (external microphone and speaker required)	
Digital I/O	Input	1 Input, dry contact, NO / NC
	Output	1 Relay Output (1A 30V DC / 0.3A 125V AC)
<b>Network</b>		
Interface	10/100 Ethernet	
Ethernet Protocol	802.1x, ARP, DHCP, DDNS, DNS, DynDNS, FTP, HTTP, HTTPS, ICMP, IGMP, IPv4, NTP, PPPoE, QoS, RTP, RTCP, RTP, RTSP, SMTP, SNMP, TCP, UDP, UPnP, ONVIF (Profile G, S, T)	
<b>Mechanical</b>		
Camera Angle Adjustment	Pan	0° ~ 360°
	Tilt	0° ~ 80°
	Rotate	0° ~ 360°
Connectors	Power	DC Jack (DC 12V, 1A), PoE (IEEE802.3af)
	Ethernet	RJ-45
	Audio	1 in (Audio In Wire); 1 out (Audio Out Wire) *The Audio In port only supports microphones with power supply.
	Digital I/O	4-pin terminal block pitch 3.5 mm (0.14")
	Local Storage	Micro SD card slot (SD / SDHC / SDXC / UHS-I, Class 10) * UHS-II card types are not supported.
TV-Out	BNC connector	
<b>General</b>		
Environment Temperature	-40°C ~ 60°C (-22°F ~ 140°F)	
Humidity	0% to 95% (no condensation)	
Power Source	12V DC / PoE (IEEE 802.3af)	
Max. Power Consumption	7.2 W	
Dimension	Ø148 x 111.3 mm (Ø5.8" x 4.4")	
Weight	0.75 kg (1.7 lb)	
Ingress Protection	IP67	
Vandal Resistance	IK10 for metal casing	
Regulatory	CE, FCC, RoHS compliant	
<b>Web Interface</b>		
Installation Management	Web-based configuration	
Maintenance	Firmware upgrade through Web Browser or Utility	
Access from Web Browser	Live View, Video Recording, Change Video Quality, Bandwidth Control, Image Snapshot, Tampering Alarm, Text Overlay, Image Masking	
Language	Czech, English, French, German, Hungarian, Italian, Japanese, Polish, Portuguese, Russian, Spanish, Traditional Chinese	
<b>Applications</b>		
Network Storage	GV-DVR / NVR (V8.7.4.0), GV-VMS (V17.1), GV-Control Center (V3.5.0.0), GV-Edge Recording Manager (V1.3.0.0), GV-Recording Server / Video Gateway (V1.4.0.0), GV-Redundant / Failover Server (V1.1.0.0)	
Smart Device Access	GV-Eye for iOS and Android	
Live Viewing	Browser (IE, Edge, Chrome, Firefox, Safari), Mobile App	

**Note:**









1. It is required to apply patch files to all the supported software.
2. Do not use clothes or any ordinary material to clean the camera cover since they may result in scratches.
3. Specifications are subject to change without notice.

### Packing List

- |                          |                   |
|--------------------------|-------------------|
| 1. IR Vandal Proof Dome  | 5. Torx Wrench    |
| 2. Waterproof Rubber Set | 6. Download Guide |
| 3. Screw Kit             | 7. Warranty Card  |
| 4. Drill Template Paster |                   |

**Note:** Power adapters can be purchased upon request.

### Accessories

Model No.	Name		Details
GV-Mount107 (must be used with GV-Mount212-2)	Pendant Bracket		Dimensions: $\varnothing$ 120 x 334 mm ( $\varnothing$ 4.72" x 13.15") Weight: 0.74 kg (1.63 lb)
GV-Mount211-2	Wall Mount and Junction Box		Dimensions: $\varnothing$ 253 x 125 x 125 mm ( $\varnothing$ 10" x 4.9" x 4.9") Weight: 0.92 kg (2.02 lb)
GV-Mount212-2	Wall Mount Bracket		Dimensions: $\varnothing$ 145 x 40 mm ( $\varnothing$ 5.7" x 1.6") Weight: 0.24 kg (0.5lb)
GV-Mount300-2	Convex Corner Mount		Dimensions: 137 x 233 x 160 mm (5.4" x 9.17" x 6.3") Weight: 1.65 kg (3.64 lb)
GV-Mount310-2	Concave Corner Mount		Dimensions: 111.2 x 369.9 x 210 mm (2.6" x 11.4" x 6.6") Weight: 1.65 kg (3.64 lb)
GV-Mount420 (must be used with GV-Mount211-2)	Pole Mount Bracket		Dimensions: $\varnothing$ 120 x 120 x 53.4 mm ( $\varnothing$ 4.7" x 4.7" x 2.1") Weight: 0.45 kg (0.99 lb) Steel Strap Diameter: $\varnothing$ 67 ~ 127 mm ( $\varnothing$ 2.6" ~ 5")
GV-Mount606	In-Ceiling Mount		Dimensions: $\varnothing$ 235 x 63 mm ( $\varnothing$ 9.3" x 2.5") In-ceiling hole: $\varnothing$ 195 mm ( $\varnothing$ 7.67") Weight: 0.49 kg (1.1 lb)
GV-Mount704 (must be used with GV-Mount107)	Extension Tube		Dimensions: $\varnothing$ 3.5 x 10 or 20 or 30 or 50 cm ( $\varnothing$ 1.38 x 3.9 or 7.9 or 11.8 or 19.7") Weight: 225g or 360g or 500g or 780g (0.5 lb or 0.79 lb or 1.1 lb or 1.72 lb)

Model No.	Name	Details
GV-PA191	Power over Ethernet (PoE) Adapter	 <p>The GV-PA191 is a Power over Ethernet (PoE) adapter designed to provide power to the IP device through a single Ethernet cable.</p>
GV-POE Switch	<p>The GV-POE Switch is designed to provide power along with network connection for IP devices. The GV-POE Switch is available in various models with different numbers and types of ports.</p>	
Power Adapter	<p>Contact our sales representatives for the countries and areas supported.</p>	