



# **NetAXS™**

## **Access Control Unit User's Guide**

The configurations described in this document have not been reviewed by Underwriters Laboratories Inc.

---

**Copyright© 2007 Honeywell. All rights reserved.**

All product and brand names are the service marks, trademarks, registered trademarks, or registered service marks of their respective owners. Printed in the United States of America. Honeywell reserves the right to change any information in this document at any time without prior notice.

Microsoft and Windows are registered trademarks of Microsoft Corporation. Windows Server is a trademark of Microsoft Corporation.

### **Ordering Information**

Please contact your local Honeywell representative or visit us on the web at [www.honeywellaccess.com](http://www.honeywellaccess.com) for information about ordering.

### **Feedback**

Honeywell appreciates your comments about this manual. Please visit us on the web at [www.honeywellaccess.com](http://www.honeywellaccess.com) to post your comments.

---

# CONTENTS



## Chapter 1 Connecting to the Web Server

1.1 Overview .....	1-1
1.2 Connecting to the NetAXS™ Web Server .....	1-2
1.3 Reading the Select Panel .....	1-7

## Chapter 2 Configuring via the Web Server

2.1 Overview .....	2-2
2.2 Configuring the System .....	2-3
2.2.1 General Tab .....	2-3
2.2.2 File Mgmt Tab .....	2-6
2.2.3 Network Tab .....	2-8
2.2.4 Site Codes Tab .....	2-9
2.2.5 Downstream Devices Tab .....	2-11
2.2.6 Host/Loop Communications Tab .....	2-12
2.3 Configuring Time Management .....	2-15
2.3.1 Current Time Tab .....	2-15
2.3.2 Time Zones Tab .....	2-17
2.3.3 Holidays Tab .....	2-19
2.4 Configuring the Doors .....	2-21
2.4.1 Reader Tab .....	2-21
2.4.2 Output Tab .....	2-28
2.4.3 Inputs Tab .....	2-30
2.5 Configuring Access Levels .....	2-34
2.6 Maintaining Cards .....	2-36
2.6.1 Adding New Cards .....	2-36
2.6.2 Displaying and Modifying Cards .....	2-39
2.6.3 Deleting Cards .....	2-40
2.6.4 Displaying Reports .....	2-41
2.7 Configuring Other I/O & Groups Tab .....	2-42
2.7.1 Inputs Tab .....	2-42
2.7.2 Outputs Tab .....	2-46
2.7.3 Groups Tab .....	2-49

---

2.8 Configuring Interlocks .....	2-51
2.9 Configuring Users .....	2-54

### **Chapter 3 Configuring via WIN-PAK**

3.1 Overview .....	3-1
3.2 Adding a New NetAXS™ Panel .....	3-2
3.2.1 Creating the Panel with Quick Start Wizard.....	3-2
3.2.2 Configuring the Panel Manually .....	3-3

### **Chapter 4 Monitoring NetAXS™ Status**

4.1 Overview .....	4-1
4.2 Monitoring Alarms .....	4-2
4.3 Monitoring Events .....	4-5
4.4 Monitoring Inputs .....	4-7
4.5 Monitoring Outputs .....	4-10
4.6 Monitoring System Status .....	4-12

### **Index**

---

# LIST OF FIGURES

Figure 1-1: NetAXS™ Web Server Hub Connection .....	1-2
Figure 1-2: NetAXS™ Web Server Direct Connection .....	1-3
Figure 2-1: NetAXS™ System Configuration Flow Chart .....	2-2
Figure 2-2: Configuration > System > File Mgmt Tab .....	2-6
Figure 2-3: Configuration > System > Network Tab .....	2-8
Figure 2-4: Configuration > System > Site Codes Tab .....	2-9
Figure 2-5: Configuration > System > Downstream Devices Tab .....	2-11
Figure 2-6: Configuration > System > Host/Loop Communications Tab .....	2-12
Figure 2-7: Configuration > Time Management > Current Time Tab .....	2-15
Figure 2-8: Configuration > Time Management > Time Zones Tab .....	2-17
Figure 2-9: Configuration > Time Management > Holidays Tab .....	2-19
Figure 2-10: Configuration > Doors > Reader Tab .....	2-21
Figure 2-11: Configuration > Doors > Output Tab .....	2-28
Figure 2-12: Configuration > Doors > Inputs Tab .....	2-31
Figure 2-13: Configuration > Access Levels .....	2-34
Figure 2-14: Cards > Add Cards .....	2-36
Figure 2-15: Cards > Card Data .....	2-39
Figure 2-16: Cards > Delete Cards .....	2-40
Figure 2-17: Configuration > Other I/O & Groups > Inputs Tab > Powerfail .....	2-43
Figure 2-18: Configuration > Other I/O & Groups > Inputs Tab > PanelTamper .....	2-43
Figure 2-19: Configuration > Other I/O & Groups > Inputs Tab > Downstream .....	2-44
Figure 2-20: Configuration > Other I/O & Groups > Outputs Tab .....	2-46
Figure 2-21: Configuration > Other I/O & Groups > Outputs Tab > Downstream .....	2-47
Figure 2-22: Configuration > Other I/O & Groups > Groups Tab .....	2-49
Figure 2-23: Configuration > Interlocks .....	2-51
Figure 2-24: Configuration > Users .....	2-54
Figure 3-1: Quick Start Wizard - Panel Screen .....	3-2
Figure 3-2: WIN-PAK Panel Configuration Screen - Basic Tab .....	3-3
Figure 3-3: WIN-PAK Panel Configuration Screen - Card Format Tab .....	3-4
Figure 3-4: WIN-PAK Panel Configuration Screen - Time Zones Tab .....	3-5
Figure 3-5: WIN-PAK Panel Configuration Screen - Options Tab .....	3-6
Figure 4-1: Status > Alarms > New Tab .....	4-2
Figure 4-2: Status > Alarms > Acknowledged Tab .....	4-3
Figure 4-3: Status > Events > Panel Tab .....	4-5
Figure 4-4: Status > Events > Web Tab .....	4-6
Figure 4-5: Status > Inputs .....	4-7

---

Figure 4-6: Status > Outputs > Discrete Tab .....	4-10
Figure 4-7: Status > Outputs > Groups Tab .....	4-10
Figure 4-8: Status > System .....	4-12

---

# LIST OF TABLES



Table 1-1: Reading the Select Panel .....	1-8
Table 2-1: Configuration > System > General Tab Fields .....	2-3
Table 2-2: Configuration > System > Host/Loop Communications Tab Field Descriptions .....	2-13
Table 2-3: Configuration > Time Management Tab Field Descriptions .....	2-16
Table 2-4: Configuration > Doors > Reader Tab Descriptions .....	2-23
Table 2-5: Configuration > Doors > Reader > Card Format Fields .....	2-25
Table 2-6: Configuration > Doors > Output Tab Field Descriptions .....	2-29
Table 2-7: Configuration > Doors > Inputs Tab Field Descriptions .....	2-33
Table 2-8: Cards > Add Cards Field Descriptions .....	2-37
Table 2-9: Cards > Reports Field Descriptions .....	2-41
Table 2-10: Configuration > Other I/O & Groups > Inputs Tab Field Descriptions .....	2-45
Table 2-11: Configuration > Other I/O & Groups > Outputs Tab > Fields .....	2-48
Table 2-12: Configuration > Other I/O & Groups > Groups Tab Field Descriptions .....	2-50
Table 2-13: Configuration > Interlocks > Field Descriptions .....	2-52
Table 3-1: Interlock Reassignments for NetAXSs™ .....	3-8
Table 4-1: Status > Alarms Field Descriptions .....	4-3
Table 4-2: Status > Events > Panel Tab Field Descriptions .....	4-5

---



---

# Connecting to the Web Server

# 1

---

## In this chapter...

Overview	1-1
Connecting to the NetAXS™ Web Server	1-2

## 1.1 Overview

A NetAXS™ access control system consists of a host system and NetAXS™ access control units that exceed existing N-1000-III/IV, Pro Series specifications and approvals, and that communicate with each other and with a variety of input and output devices. Each access control unit, or panel, has four reader ports. See the *NetAXS™ NX4L1 Installation Guide* or *NetAXS™ NX4S1 Installation Guide* to view illustrations of the supported NetAXS™ system configurations.

You access the NetAXS™ access control unit either through a host software system or by connecting to the NetAXS™ web server by an Ethernet connection. This chapter describes how to connect to the NetAXS™ web server. Chapter 2 describes how to use the NetAXS™ web interface after you are connected to the NetAXS™ panel through the NetAXS™ web server. Chapter 3 describes how to use the web server interface.

## 1.2 Connecting to the NetAXS™ Web Server

This section describes how to connect a computer to the NetAXS™ web server via Ethernet and Internet Explorer.



**Notes:**

- The NetAXS™ panel that you are connecting to the computer is the Gateway panel. DIP switch 6 on a Gateway panel must be set to ON for a successful connection.
- The Microsoft Windows™ screen captures used in this section reflect the Windows 2000™ platform. If you are using another Windows™ platform, the screens will be somewhat different.

Perform the following steps:

1. Connect your computer's Ethernet port and the NetAXS™ panel's Ethernet Port by using either of two methods:
  - a. Connect both the computer's Ethernet port and the NetAXS™ panel's Ethernet port to an Ethernet hub with standard straight-through Ethernet patch cables.

*Figure 1-1: NetAXS™ Web Server Hub Connection*

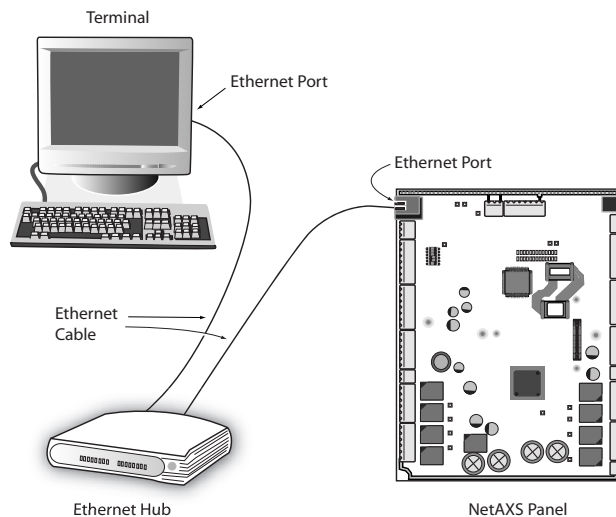

- b. Connect the computer's Ethernet port directly to the NetAXS™ panel's Ethernet port with an Ethernet crossover cable. A crossover cable is a cable that maps all output signals on one connector to the input signals on the other connector. This allows the computer and the NetAXS™ panel to perform full-duplex Ethernet communication through an Ethernet hub or switch.

*Figure 1-2: NetAXS™ Web Server Direct Connection*

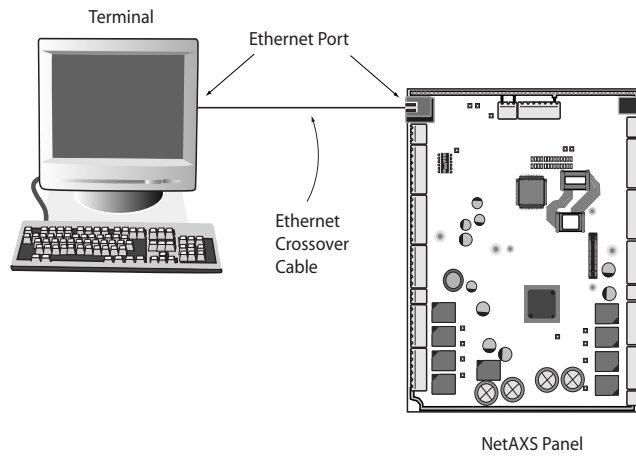

2. Configure the computer's network connection:
  - a. Select **Start > Settings > Control Panel**.
  - b. Click **Network and Dial-up Connections**.

- c. Identify your local Ethernet connection (commonly labelled **Local Area Connection**), and right click the icon to display the Local Area Connection Properties screen.

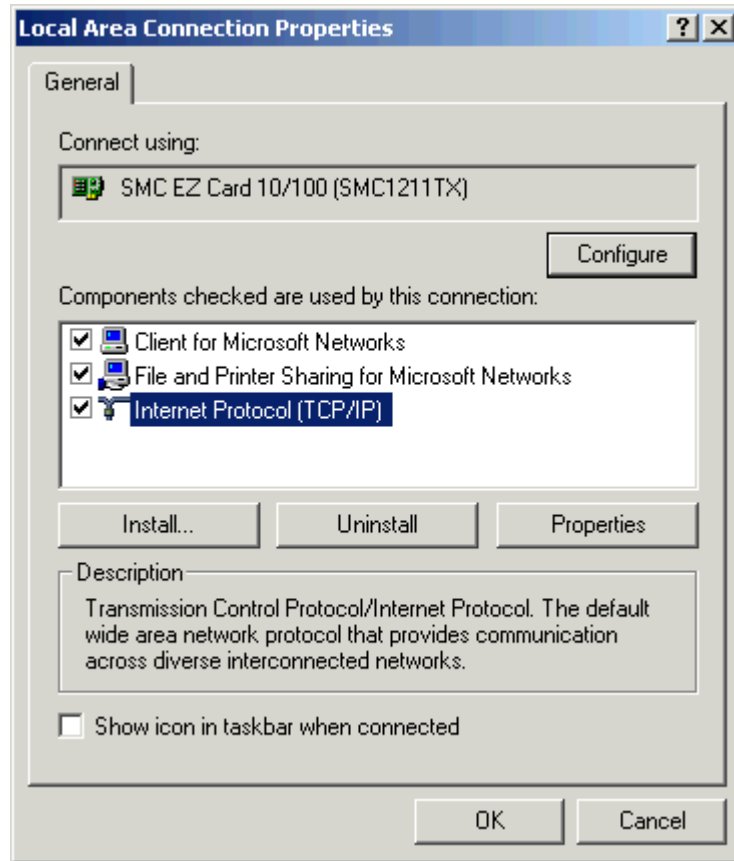

- d. Highlight the Internet Protocol (TCP/IP) connection.
- e. Click **Properties** to display your system's current Internet Protocol properties.
- f. **Important:** Keep a record of your computer's current network configuration as it appears in this screen. You will need to re-instate this configuration later.
- g. Select "Use the following IP address."
- h. Enter "192.168.1.10" in the IP address field.
- i. Enter "255.255.255.0" in the Subnet mask field.
- j. Enter "192.168.1.1" in the Default gateway field.

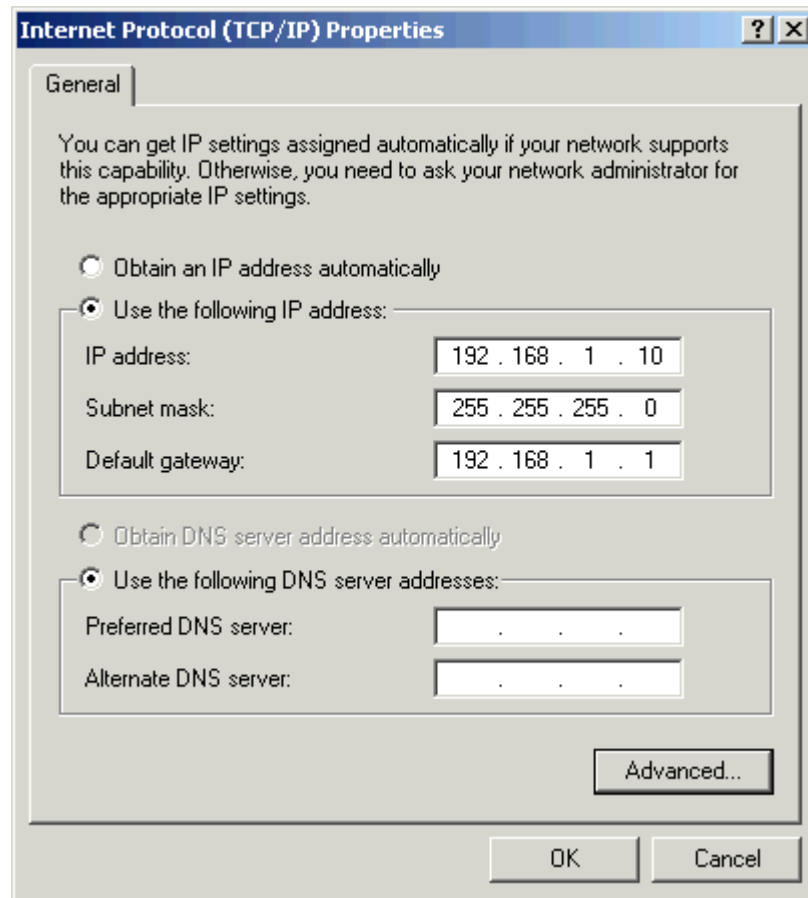

- k. Click **OK** to accept the entries.
3. Open your browser (Internet Explorer shown below), and enter `https://192.168.1.150` as the target address.

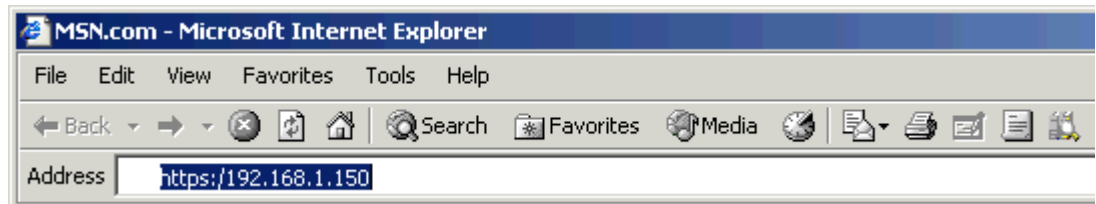

4. Press the **Enter** key to display the Honeywell NetAXS™ login screen.

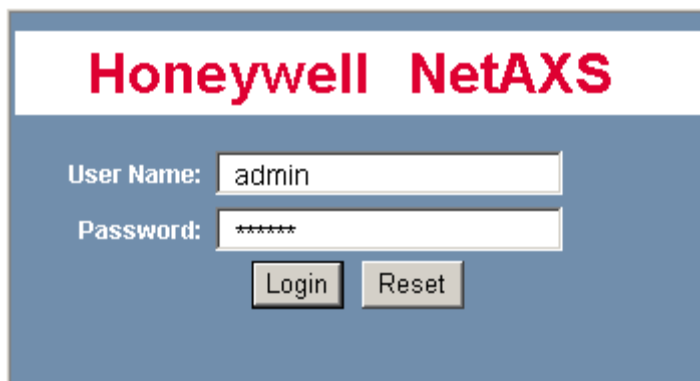

The screenshot shows a web browser window with a blue header containing the text "Honeywell NetAXS" in red. Below the header, there is a login form with a blue background. The form contains two input fields: "User Name:" with the text "admin" and "Password:" with the text "\*\*\*\*\*". Below the input fields are two buttons: "Login" and "Reset".

5. Enter “admin” in the User Name field, and enter “admin” in the Password field. Both the user name and password are case-sensitive.
6. Click **Login** to display the NetAXS™ main window. Note that the Select Panel column on the right edge of the screen displays all panels available to the computer. This list will include the gateway panel that you are connected to over Ethernet and any downstream panels connected via RS-485 to the Gateway panel.

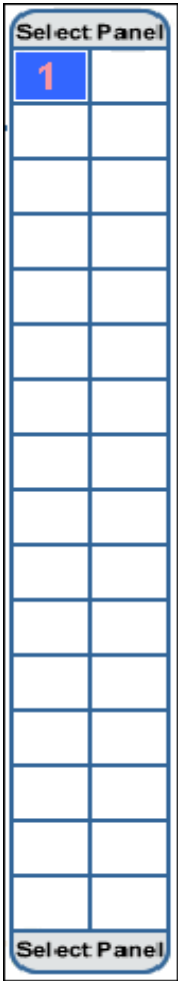

**Note:** It is recommended that you change your default user name (admin) and password (admin) to a new user name and password at this time. To do this, proceed to the instructions in Chapter 2, *Configuring the NetAXS System™*, [Steps to modify a user:](#), page 55.

### 1.3 Reading the Select Panel

The Select Panel is located at the right margin of the NetAXS web server main screen, shown in the preceding section. The presence of a number in one of the Select Panel cells indicates that its associated panel is online. For example, if you see a number 1 in a cell, this indicates that panel 1 is online. The combinations of size and color of the number and the color of the cell background indicate the panel's status, as shown in the following table:



**Note:** Holding the cursor over a cell also displays a popup message, which conveys the panel in that cell is online or selected.

**Table I-1:** Reading the Select Panel

Cell Display	Status
<p>Large red number on a blue background, such as “1” in the example below:</p> 	<p>Panel 1 is selected, and it has unacknowledged alarms.</p>
<p>Small black number on white background, such as “2” in the example below:</p> 	<p>Panel 2 is not selected and it has no unacknowledged alarms.</p>
<p>Large white number on blue background, such as “2” in the example below:</p> 	<p>Panel 2 is selected, and it has no unacknowledged alarms.</p>



Table 1-1: Reading the Select Panel (continued)

Cell Display	Status
<p>Small white number on a red background, such as “1” in the example below:</p> 	<p>Panel 1 is not selected, but it does have unacknowledged alarms.</p>

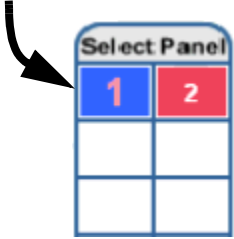
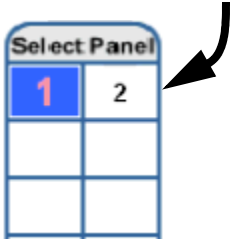
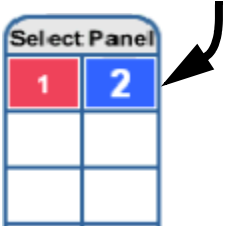
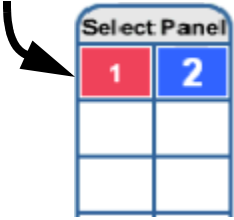

---

# Configuring via the Web Server **2**

---

Overview	2-2
Configuring the System	2-3
Configuring the Doors	2-21
Configuring Other I/O & Groups Tab	2-42
Configuring Interlocks	2-51
Configuring Time Management	2-15
Configuring Access Levels	2-34
Configuring Users	2-54

## 2.1 Overview

This chapter explains the NetAXS™ configuration functions as accessed via the NetAXS™ web server. These functions should be performed only by the NetAXS™ system administrator or service personnel.



**Caution:** The sequence of NetAXS™ configuration tasks is critical. If the sequence given below is not followed, the NetAXS™ system cannot be successfully configured.

The flow chart in [Figure 2-1](#) shows the order in which to perform the administrative functions.

**Figure 2-1:** *NetAXS™ System Configuration Flow Chart*

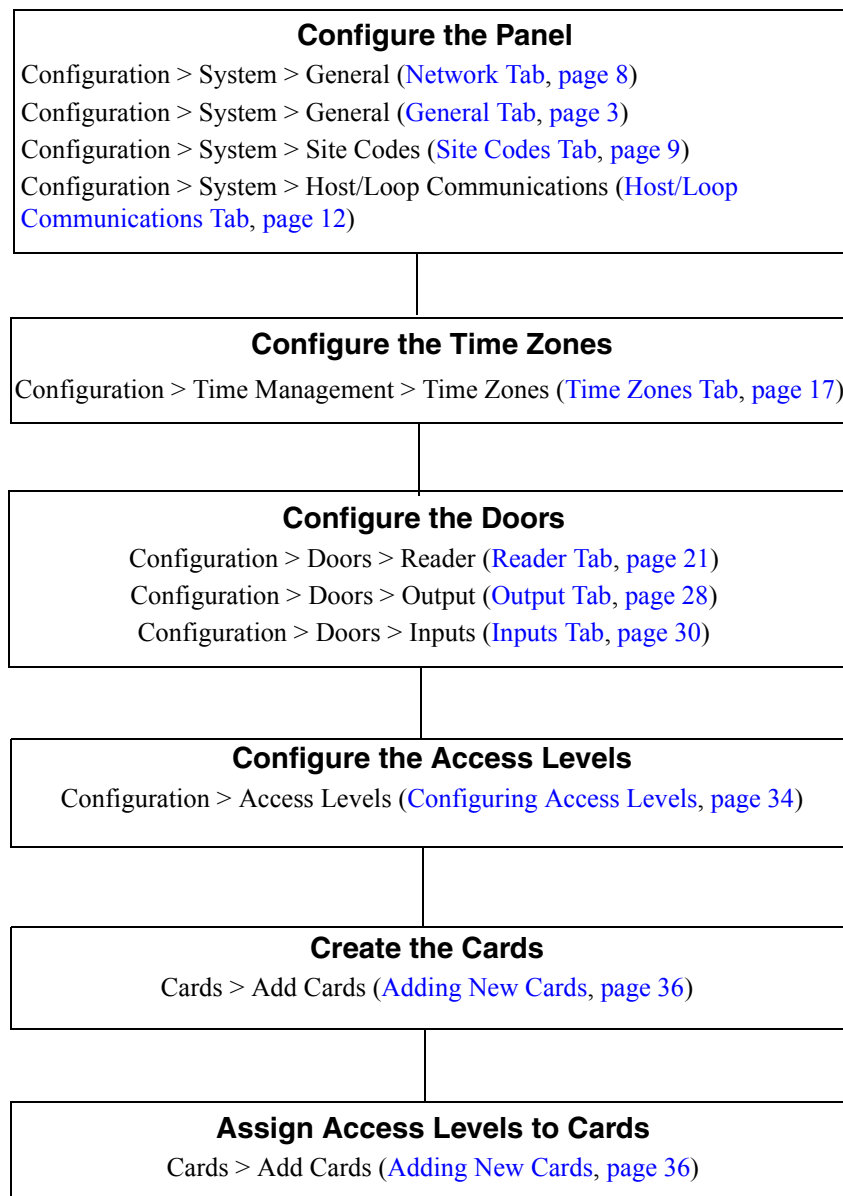

## 2.2 Configuring the System

Click **Configuration > System** in the NetAXS™ menu to display the System Configuration (General) screen:

### System Configuration - Panel 1

General
File Management
Network
Site Codes
Downstream Devices
Host / Loop Communications

Name	<input type="text" value="NetAXS"/>	Gateway Panel Addr	1
Address	1	Web Session Timeout	<input type="checkbox"/> Disabled <input type="text" value="0"/> minutes
Type	NetAXS	Use PIN	<input type="checkbox"/> Enabled
		Free Egress	<input type="checkbox"/> Enabled
Boot Time	Wed Jun 20 12:36:06 2007	Duress Detect	<input type="checkbox"/> Enabled
Reset	<input type="button" value="Reset Panel 1"/>	Continuous Card Reads	<input type="checkbox"/> Enabled
		Reader LEDs	<input type="checkbox"/> Reverse LED color
Anti-Passback	<input checked="" type="checkbox"/> Enabled <input type="radio"/> Local <input type="radio"/> Global <input type="checkbox"/> Forgiveness	Cardholder 'Note1'	<input type="text" value="Note1:"/>
		Cardholder 'Note2'	<input type="text" value="Note2:"/>

### 2.2.1 General Tab

The General Tab enables you to:

- Set the general configuration settings.
- Reset the panel.

**Steps:** Use the descriptions in the following table to configure the general settings, and click **Submit Changes**:

*Table 2-1: Configuration > System > General Tab Fields*

Parameter	Description
Name	Unique name that identifies the panel.
Address	Displays the address set by the panel's DIP switches.
Type	Displays "NetAXS" as the panel type.
Boot Time	Displays the time that power was applied to the NetAXS™ panel.

**Table 2-1:** Configuration > System > General Tab Fields (continued)

Parameter	Description
Reset	Reboots the panel. A reset does not change the current configuration in the database.
Cardholder Note 1	Specifies any information field you might want to put on a card. For example, if you enter “Department” here, a field labeled “Department” appears on the card. The user who creates the card would then enter the cardholder’s department name. See <a href="#">Adding New Cards, page 36</a> .
Anti-Passback	<p><b>Enabled</b> – Enables anti-passback, which prevents an entrant to an area from passing his card back to another potential entrant.</p> <p><b>Local</b> – Enforces anti-passback only at doors configured locally to the panel controlling the original card read.</p> <p><b>Global</b> – Enforces anti-passback at panels throughout the NetAXS™ system after a successful card read at any one of the system’s readers.</p> <p><b>Forgiveness</b> – Causes all system codes to be reset at midnight every day. This enables a cardholder who exited the building in the evening without using his card to use his card for entry the following morning.</p>
Gateway Panel Addr	Sets the panel address of the Gateway panel, or the panel directly connected to the host system.
Web Session Timeout	<p><b>Disabled</b> – Disables the timeout.</p> <p><u>    </u> <b>Minutes</b> – Activates a web session timeout after the specified number of minutes has elapsed.</p>
Use PIN	<b>Enabled</b> – Requires a valid PIN verification.
Free Egress	<b>Enabled</b> – Configures the panel for free egress. Reader 1 activates output 1, reader 2 activates output 2, reader 3 activates output 3, and reader 4 activates output 4. Inputs 1, 3, 5, and 7 are egress defaults that activate outputs 1, 2, 3, and 4, respectively. Inputs 2, 4, 6, and 8 are status defaults for outputs 1, 2, 3, and 4, respectively.

*Table 2-1: Configuration > System > General Tab Fields (continued)*

Parameter	Description
Duress Detect	<p><b>Enabled</b> – Enables the user to trigger an alarm or output device in times of duress, such as when the operator is forced to grant access against his will to an unauthorized person. This feature is available only when the reader is configured with a “Card and Pin” access mode (see <a href="#">Reader Tab, page 21</a>).</p> <p>When this feature is enabled, you can configure an auxiliary output with a pulse time and connect it to a device with an interlock (see “<a href="#">Outputs Tab</a>“ on page 46 for the output configuration).</p> <p>During normal operation, the duress output does nothing. To energize the output, the cardholder presents his card to a reader that is configured for Card and PIN access (see “<a href="#">Reader Tab</a>“ on page 21). The cardholder then enters a PIN that is either one number higher or one number lower than his correct PIN. For example, if his PIN is 2222, the cardholder would enter either 2221 or 2223. Even though the PIN is incorrect, the door will still open normally, but the duress output pulses and an alarm is generated. In this way, the cardholder notifies others without detection by the unauthorized person.</p>
Continuous Card Reads	<p><b>Enabled</b> – Enables continuous card reading while the output is being energized. When this option is not enabled, a reader will not be able to read a second card during the pulsing of the output caused by the previous card read.</p>
Reader LEDs	<p>Identifies the color of a reader LED when a grant is authorized.</p>
Cardholder Note 2	<p>Specifies any information field you might want to put on a card. For example, if you enter “Phone Number” here, a field labeled “Phone Number” appears on the card. The user who creates the card would then enter the cardholder’s telephone number. See <a href="#">Adding New Cards, page 36</a>.</p>
Card Use Types	<p><b>Visitor Cards (limited days)</b> – Specifies a card for a visitor that can be used only a limited number of days. The specified period begins at the time the card is created. If you select this option,</p> <p><b>Limited-Use Cards</b> – Specifies a card that can be used only a limited number of times.</p> <p><b>Neither</b> – Specifies all cards other than visitor or limited-use cards.</p>

## 2.2.2 File Mgmt Tab

Firmware is software that is embedded in the NetAXS™ board. The firmware provides this web interface and all access control functionality. Periodically, the firmware is updated. This tab enables you to download new versions of the firmware, revert to a previous version of the firmware, upload and/or download card and configuration databases.

Click **File Mgmt** to display the File Management tab:

*Figure 2-2: Configuration > System > File Mgmt Tab*

The screenshot displays the 'File Mgmt Tab' interface. At the top, there is a blue header bar with the text 'Version Information'. Below this is a table with five columns: 'Active Image', 'Name', 'Version', 'Date', and 'Time'. The table contains two rows of data. Below the table, there are two main sections: 'Upload (from panel):' and 'Download (to panel):'. The 'Upload' section has three radio buttons: 'Cards Only', 'Configuration Only', and 'All' (which is selected), followed by an 'Upload' button. The 'Download' section has a text input field followed by a 'Browse...' button and a 'Download' button.

Active Image	Name	Version	Date	Time
<input type="radio"/> Set A	Access Control App	0.1.34	02/27/2007	16:56:35
<input checked="" type="radio"/> Set B	Access Control App	0.1.45	04/25/2007	12:26:29

**Upload (from panel):**

Cards Only    Configuration Only    All   **Upload**

**Download (to panel):**

**Browse...**

**Download**

### The File Mgmt tab enables you to:

- View the current firmware configuration.
- Download firmware from the host to the panel.
- Revert to a previous firmware version.
- Upload card and configuration data from the panel to the host system.

### Steps to download firmware from the host to the panel:

1. Click **Browse** to locate the firmware file.
2. Click **Download** to download the firmware.

### Steps to revert to the previous firmware version:

1. In the Active Image column, click to select the firmware version to which you want to revert. The prompt “Switching to an alternate firmware set requires a panel reboot” appears.
2. Click **OK** to reboot the panel.



**Steps to upload data from the panel to the host:**

1. Select either Cards Only, Configuration Only, or All to send card data, configuration data, or both, respectively.
2. Click **Upload** to upload the data to the host.

### 2.2.3 Network Tab

Your NetAXS™ panel is physically configured in one of a number of possible network configurations. See the “System Configuration” section in the *NetAXS™ NX4L1 Installation Guide* or *NetAXS™ NX4S1 Installation Guide* for illustrations of the supported network configurations. For the panel to function in any of these configurations, the other panels and devices in the network must know the panel’s network addresses.

Click **Network** to display the Network tab:

**Figure 2-3:** Configuration > System > Network Tab

<b>MAC Address</b>	xx.xx.xx.xx.xx.xx
<b>IP Address</b>	<input checked="" type="radio"/> Static: <input type="text"/> . <input type="text"/> . <input type="text"/> . <input type="text"/>
	<input type="radio"/> DHCP:
<b>Subnet Mask</b>	<input type="text"/> . <input type="text"/> . <input type="text"/> . <input type="text"/>
<b>Default Gateway</b>	<input type="text"/> . <input type="text"/> . <input type="text"/> . <input type="text"/>

Submit Changes

**The Network tab enables you to:**

- View the panel’s MAC address.
- View and edit the panel’s IP address.
- View and edit the panel’s subnet mask.
- View and edit the panel’s default gateway.

## 2.2.4 Site Codes Tab

Site codes identify an enterprise's site. You can create a maximum of eight site codes to serve as secondary IDs (in addition to the card number) on the card for additional validation.

Click **Site Codes** to display the Site Codes tab:

*Figure 2-4: Configuration > System > Site Codes Tab*

Num	Site Code Name	Site Code Number
1	Site 1	1
2	Site 2	2
3	Site 3	3
4	Site 4	4
5	Site 5	5

Name:  Site Code:

Add Site Code

Delete All Codes

### The Site Codes tab enables you to:

- View existing site codes.
- Create one or more site codes.
- Modify an existing site code.
- Delete a selected site code.
- Delete all site codes.

### Steps to delete all site codes:

1. Click **Delete All Codes** to display a prompt.
2. Click **OK** to delete the codes.

**Steps to create a site code:**

1. Enter a name for the site code in the Name field.
2. Enter a unique number (up to five digits) for the site code in the Site Code field.
3. Click **Add Site Code** to create the site code.

**Steps to modify a site code:**

1. Click the site code's number in the Num column to select the site code.

Num	Site Code Name	Site Code Number
1	Site 1	1
2	Site 2	2
3	Site 3	3
4	Site 4	4
5	Site 5	5

**Name:**  **Site Code:**

2. Click **Modify** to display the Name and Site Code fields.
3. Modify the name or site code number as you desire, and click **Modify** again.

**Steps to delete a site code:**

1. In the Num column, click the number of the site you want to delete.
2. Click **Delete** to display a prompt.
3. Click **OK** to delete the site code.

## 2.2.5 Downstream Devices Tab

The NetAXS™ downstream devices are Monitorable Input Relay Output (MIRO) boards. These boards provide the NetAXS™ panel with additional inputs and outputs.

The NetAXS™ panel supports two MIRO types:

- 32/0 – Provides 32 inputs and no outputs. The 32/0 MIRO boards must be assigned network addresses 1 and 2.
- 2/16 – Provides two inputs and 16 outputs. The 2/16 MIRO boards must be assigned network addresses 3-6.



**Note:** The MIRO network addresses are set by the DIP switches on each board. Refer to the “Downstream I/O” section in the *NetAXS™ Access Control Unit NX4LI Installation Guide* or the *NetAXS™ Access Control Unit NX4SI Installation Guide* for more information about setting MIRO DIP switches.

A NetAXS™ panel supports a maximum of six daisy-chained MIROs – two 32/0 boards and four 2/16 boards. The boards connect to the NetAXS™ panel’s Downstream port (Terminal Block 10).

Click the **Downstream Devices** tab:

**Figure 2-5:** Configuration > System > Downstream Devices Tab

Online Modules		
Name	Type	Address
Downstream #3 MIRO 2/16	MIRO 2/16	3

**The Downstream Devices tab enables you to:**

- View and modify the names of the devices that communicate with the panel.
- View the types and addresses of the devices that communicate with the panel.

**2.2.6 Host/Loop Communications Tab**

In order to maintain your NetAXS™ system configuration or to monitor its status, you must connect to the NetAXS™ panel by using one of two modes:

- Host mode (monitor only) – a host software system, such as WIN-PAK™, connects to the panel (through the NetAXS™ gateway panel, which has an on-board PCI communications adapter), and it enables you to monitor the status of the NetAXS™ system. The on-board PCI adapter functions as an interface between a host computer’s RS-232 port and one or more panels connected on the Multidrop line.
- Web mode (configure and monitor) – the NetAXS™ web server connects to the panel and enables you to configure the panel and monitor system status.

This tab enables you to select and configure the communication mode you will use to connect to the panel.

Click the **Host/Loop Communications** tab:

*Figure 2-6: Configuration > System > Host/Loop Communications Tab*

Host	Connection Type	<input type="radio"/> Direct via TCP/IP	<b>Host Mode</b>
		<input type="radio"/> Direct via RS232	
	<input type="radio"/> Hub Mode (modem)	<b>Web Mode</b>	
	<input checked="" type="radio"/> None		
	Comms Type		<input type="radio"/> Ack/NAK <input type="radio"/> Non Ack/NAK
Baud Rate	<input type="radio"/> 9600 bps <input type="radio"/> 19,200 bps <input type="radio"/> 38,400 bps <input type="radio"/> 57,600 bps <input type="radio"/> 115,200 bps		
Port Number	<input type="text" value="3001"/>		
Time Sync	<input type="checkbox"/> Enabled		
Loop	Baud Rate	<input type="radio"/> 38,400 bps <input checked="" type="radio"/> 115,200 bps	<input type="button" value="Force Baud Reset"/>
<input type="button" value="Submit Changes"/>			

**The Host/Loop Communications tab enables you to:**

- Configure the following host settings:
  - Connection type (host or web server)
  - Communications type
  - Baud rate
  - Port number
  - Time sync
- Configure the loop baud rate for communication among downstream panels.

**Steps:** Use the descriptions in the following table to configure the settings:

*Table 2-2: Configuration > System > Host/Loop Communications Tab Field Descriptions*

Host/Loop	Setting	Description
Host	Connection type	<p>Specifies the type of physical connection between the host and the panel on the Gateway panel.</p> <p>If you are connecting from a host software system such as WIN-PAK, select one of the following three connection options:</p> <p><b>Direct via TCP/IP</b> – Host connects directly to the panel using the TCP/IP protocol.</p> <p><b>Direct via RS-232</b> – Host connects directly to the panel via the RS-232 protocol.</p> <p><b>Hub Mode (modem)</b> – Host and the panel both connect to a modem.</p> <p>If you will be connecting to the panel through the NetAXS™ web server, click <b>None</b>.</p>
	Comms Type	<p>Specifies the type of communications.</p> <p><b>Ack/NAK</b> – Provides a response (either an acknowledgement or a non-acknowledgement) in a transmission between the host and panel(s). This is the recommended communications type.</p> <p><b>Non Ack/NAK</b> – Does not provide a response (either an acknowledgement or a non-acknowledgement) in a transmission between the host and panel(s).</p>
	Baud Rate	<p>Specifies the transmission rate (bits per second) between the host and the panel. Select the highest rate that your modem will support.</p>

*Table 2-2: Configuration > System > Host/Loop Communications Tab Field Descriptions (continued)*

Host/Loop	Setting	Description
	Port Number	Specifies the port number for the Ethernet port (default is 3001).
	Time Sync	Synchronizes the panel's time with the host's time. <b>Enabled</b> – Causes the panel(s) to be automatically time-synchronized with the host.
Loop	Baud Rate	Specifies the transmission rate (bits per second) among the downstream NetAXS™ panels on the loop. For NetAXS downstream panels, it is recommended that you select 115,200.
	Force Baud Reset	Tells all downstream NetAXS panels to change to the selected Downstream baud rate. This saves the user from having to go to each panel one by one



## 2.3 Configuring Time Management

This set of time-related functions includes:

- Setting the current time by which the panel will function.
- Creating the time zones by which the panel will control the operation of the inputs, outputs, groups, readers, access levels, and cards through access levels.
- Defining the holiday schedule.

### 2.3.1 Current Time Tab

Click **Current Time** to display the Current Time screen:

*Figure 2-7: Configuration > Time Management > Current Time Tab*

Current Loop Time	Mon Apr 16 18:45:09 2007
Format	<input checked="" type="radio"/> 12 hour <input type="radio"/> 24 hour
New Date	-
New Time	- - AM
Geographic Time Zones	<ul style="list-style-type: none"><li>GMT-5</li><li>GMT-6</li><li>GMT-7</li><li>GMT-8</li><li>GMT-9</li><li>Greenwich</li><li>UCT</li><li>UTC</li><li>Universal</li><li>Zulu</li></ul>
Time Server	<input type="checkbox"/> Enabled Update Interval: 3 days
(Not Running)	1 .1 .1 .1 <input type="button" value="Force Timesync"/>

**The Current Time tab enables you to:**

- Set the current loop time.
- Specify the time format (12 hour/24 hour).
- Set a new date.
- Set a new time.
- Set the geographic time zone.
- Specify the time server being used.
- Force a time synchronization between the panel and the time server.

**Steps:** Use the descriptions in the following table to configure the time settings:

**Table 2-3:** Configuration > Time Management Tab Field Descriptions

Setting	Description
Current loop time	Displays by default the current time setting.
Format	<b>12 hour</b> – The 24-hour day is divided into two 12-hour halves, a.m. and p.m.; each half is numbered 1-12. <b>24 hour</b> – The hours in the 24-hour day are numbered consecutively 0-23.
New Date	Specifies a new date to be the current date.
New Time	Specifies a new time to be the current time.
Geographic Time Zone	Select the geographic time zone in which the panel will operate.
Time Server	Enter the IP address of the machine whose time is used as the standard for all panels. <b>Enabled</b> – Select to enable the specified machine to be the active time server. <b>Update Interval</b> – Specifies the interval of time between each automated synchronization. <b>Force Timesync</b> – Synchronizes the time between the time server and panel(s) manually.

## 2.3.2 Time Zones Tab

The NetAXS™ panel controls access by using time zones, or time schedules. Inputs, outputs, groups, readers, access levels, and cards through access levels are all configured with time zones by which they will be energized or de-energized, enabled or disabled. For example, you might assign a group of outputs to be energized from 12:00 a.m. to 6:00 a.m. every day. The 12:00 a.m. to 6:00 a.m., Sunday through Saturday, time period is called a time zone. The Time Zones tab enables you to create the time zones you will use to configure your NetAXS™ system.

Click **Time Zones** to display the Time Zones screen:

**Figure 2-8:** Configuration > Time Management > Time Zones Tab

Tz	Name	Start Time	End Time	Days of Week	Holidays	Link Tz
1	Default Time Zone (24x7)	12:00 AM	11:59 PM	MTWTFSS	T1, T2, T3	-
2	Time Zone 1	12:00 AM	8:00 AM	MTWTF--	T1	-
3	Time Zone 2	7:30 AM	4:30 PM	MTWTF--	T1	1
4	Time Zone 3	4:00 PM	12:30 AM	MTWTF--	T2	2

Name:

Start Time:  -  -  End Time:  -  -

---

Monday  
  Tuesday  
  Wednesday  
  Thursday  
  Friday  
  Saturday  
  Sunday  
  Type 1 Holidays  
  Type 2 Holidays  
  Type 3 Holidays

---

Exclude Holidays  
 Link to Time Zone

### The Time Zones tab enables you to:

- Create a new time zone.
- Modify a time zone.
- Delete a time zone.

**Steps to create a time zone:**

1. Enter the name of the new time zone in the **Name** field.
2. Enter a start time and an end time for the time zone.
3. Select the days of the week during which the time zone will be in effect.
4. If the time zone will not be in effect during holidays, select the **Exclude Holidays** checkbox.
5. If the time zone will be linked to another time zone, select the “linked to” time zone’s number from the drop down list.
6. Click the **Add Time Zone** button.

**Steps to modify a time zone:**

1. In the Tz column, click the number of the time zone you want to modify.
2. Change the time zone settings as you desire.
3. Click the **Modify** button to accept the changes.

**Steps to delete a time zone:**



**Caution:** Do not delete a time zone that is currently in use.

1. In the Tz column, click the number of the time zone you want to delete.
2. Click the **Delete** button.
3. Click **OK** at the delete prompt.

### 2.3.3 Holidays Tab

Holidays are days when no work is scheduled at the facility. These holidays are used in time zone configuration (see “[Time Zones Tab](#)“ on page 17).

Click the **Holidays** tab:

**Figure 2-9:** Configuration > Time Management > Holidays Tab

Holiday	Name	Start Date	End Date	Start Time	End Time	Annual
1	Thanksgiving	November 22	January 24	6:00 PM	6:00 AM	-
2	Christmas	December 24	January 2	5:00 PM	6:00 AM	√
3	Independence Day	July 4	July 4	-	-	√
4	Memorial Day	May 25	May 25	-	-	-

Name:

Single day  
  Multiple day  
  Annual  
  Type 1  
  Type 2  
  Type 3

---

Start Date:  -  -      
 Start Time:  -  -

End Date:  -  -      
 End Time:  -  -

---

**The Holidays tab enables you to:**

- Create a holiday.
- Modify a holiday.
- Delete a holiday.

**Steps to create a holiday:**

1. Enter the name of the new holiday in the **Name** field (up to 25 characters).
2. If the holiday’s duration is one day, select **Single day**. If the holiday’s duration will be more than one day, select **Multiple day**.
3. If the holiday will occur annually, select the **Annual** checkbox.
4. Assign a type to the holiday, either Type 1, Type 2, or Type 3. The type you assign will map to a time zone configuration, and the holiday will be regarded according to the rules of that time zone (see “[Time Zones Tab](#)“ on page 17).

5. Select the holiday's month and date from the drop down lists.
6. Click the **Add Holiday** button.

**Steps to modify a holiday:**

1. In the Holiday column, click the number of the holiday you want to modify.
2. Change the holiday settings as you desire.
3. Click the **Modify** button to accept the changes.

**Steps to delete a holiday:**

1. In the Holiday column, click the number of the holiday you want to delete.
2. Click the **Delete** button.
3. Click **OK** at the delete prompt.

## 2.4 Configuring the Doors

Each NetAXS™ panel supports four doors. For each door, you must configure the readers, inputs, and outputs.

At **Configuration > Doors** in the task menu at the left margin of the NetAXS™ screen, click **1** to display the Door Configuration screen for door 1. Follow the same procedures below for doors 2, 3, and 4 for each panel.

### 2.4.1 Reader Tab

A reader is a device that reads cards and either grants or denies access at the door.

Click the **Reader** tab:

*Figure 2-10: Configuration > Doors > Reader Tab*

---

**General**   Card Formats

<b>Access Mode</b>	<b>Disabled</b> Time Zone:	<input type="text" value="Time Zone 1"/>	<input type="radio"/> Supervisor	<input type="radio"/> Escort	<input checked="" type="radio"/> Neither
	<b>Lockdown</b> Time Zone:	<input type="text" value="Time Zone 3"/>	<input type="radio"/> Supervisor	<input type="radio"/> Escort	<input checked="" type="radio"/> Neither
	<b>Card and Pin</b> Time Zone:	<input type="text" value="Time Zone 2"/>	<input type="radio"/> Supervisor	<input type="radio"/> Escort	<input checked="" type="radio"/> Neither
	<b>Card or Pin</b> Time Zone:	<input type="text" value="Default Time Zone (24x7)"/>	<input checked="" type="radio"/> Supervisor	<input type="radio"/> Escort	<input type="radio"/> Neither
	<b>Card Only</b> Time Zone:	<input type="text" value="Default Time Zone (24x7)"/>	<input type="radio"/> Supervisor	<input type="radio"/> Escort	<input type="radio"/> Neither
	<b>Pin Only</b> Time Zone:	<input type="text" value="-"/>			
<b>Anti-Passback</b>	<input checked="" type="checkbox"/> Enabled	<input checked="" type="radio"/> Hard	<input type="radio"/> Soft	(disabled via <a href="#">System Configuration</a> )	
		<input type="radio"/> In	<input checked="" type="radio"/> Out		

---

**The Reader tab enables you to:**

- Define the time zone during which the reader will be disabled. When the reader is disabled, neither exit nor entry by Card and PIN mode or Card or PIN mode is allowed. Also, free egress is not allowed.
- Define the time zone during which the reader will be in lockdown mode (see [Time Zones Tab, page 17](#) for details about setting time zones). When the reader is in lockdown mode, entry is prevented but egress is still allowed.
- Define the reader's access mode (the combination of card and/or PIN entry required by the reader). Note that the access mode defined here for the door can be overridden by a card assigned with a VIP card type (see "[Adding New Cards](#)" on page 36 for information about assigning a VIP card type).
- Enable the Card Only, PIN Only, Card and PIN, and Card or PIN access modes with either the Supervisor or Escort rule:
  - Supervisor Rule: When the supervisor presents his card during the specified time zone just once, he gains access but does not enable access for non-supervisory personnel.
  - Escort Rule: This rule requires a supervisor escort for a non-supervisor.
- Configure the anti-passback feature. When enabled, the anti-passback feature prevents an entrant to an area from passing his card back to another potential entrant. Note that anti-passback must first be enabled at the **Configuration > System > General** screen (see [General Tab, page 3](#)).
- Specify the data format the reader must use to read the card data.
- Reconfigure a selected format's data layout.



**Steps:**

1. Use the descriptions in the table below to configure the General reader settings.

*Table 2-4: Configuration > Doors > Reader Tab Descriptions*

Setting	Description
Access Mode	<p>Specifies the validation conditions required at the door before access is granted. For each access mode, you must also select a time zone from the drop down list. The time zone is the schedule by which the access mode is effective.</p> <p><b>Disabled</b> – Allows neither exit nor entry by Card and PIN mode or Card or PIN mode. Also, free egress is not allowed.</p> <p><b>Lockdown</b> – Denies door entry but allows egress.</p> <p><b>Card Only</b> – Grants access with only a successful card read.</p> <p><b>Pin Only</b> – Grants access with only a valid PIN number entered at the door’s keypad.</p> <p><b>Card or Pin</b> – Grants access with either a successful card read or a valid PIN number entry at the door’s keypad.</p> <p><b>Card and Pin</b> – Grants access only with both a successful card read and a valid PIN entry at the door’s keypad. You can perform the card read and PIN entry in either sequence.</p> <p><b>Supervisor</b> – Enables a supervisor to enter without allowing access to others. When the supervisor presents his card during the time zone just once, he gains access but does not enable access for non-supervisory personnel. If the supervisor presents his card twice, he enables access for all non-supervisory personnel as well. After the supervisor presents his card twice to allow general access, he can disable the general access for the time zone by presenting his card again twice consecutively.</p> <p><b>Escort</b> – Requires a supervisor escort for a non-supervisor cardholder. The supervisor must present his card first, then the non-supervisor must present his card within ten seconds of the supervisor’s card read.</p>

**Table 2-4:** Configuration > Doors > Reader Tab Descriptions (continued)

Setting	Description
Anti-Passback	<p>Configures the anti-passback feature, which prevents an entrant to an area from passing his card back to another potential entrant. Note that anti-passback must first be enabled at the <b>Configuration &gt; System &gt; General</b> screen (see <a href="#">General Tab, page 3</a>).</p> <p><b>Enabled</b> – Enables the anti-passback feature.</p> <p><b>Hard</b> – Does not allow a second entry on the same card without an exit.</p> <p><b>Soft</b> – Allows a second entry on the same card without an exit; however, an event is generated that indicates the second entry.</p> <p><b>Out</b> – Applies to readers located inside the area. Cardholders use these readers when attempting to exit the area.</p> <p><b>In</b> – Applies to readers located outside the area. These are readers that cardholders use when attempting to enter the area.</p>

2. Click **Card Formats** at the top of the tab. A card format tells the panel how the card number will be read. The panel supplies the format to the card readers. Then, the card readers can correctly read the card.

General [Card Formats](#)

### Formats Recognized by Reader 1

Double-click on a format name to display or edit its data layout

**Available**

Default 35 Bit Wiegand  
 Default 25 Bit Wiegand  
 Default 29 Bit Wiegand  
 Default 37 Bit Wiegand

**Selected**

Default 26 Bit Wiegand  
 Default 32 Bit Wiegand  
 Default 34 Bit Wiegand

- Click to highlight each desired card format listed in the Available box, and click the green right arrow  button to move the format(s) into the Selected box.



**Note:** If you select no formats, the reader will function in legacy mode and the reader interprets the panel's formats. If you select a subset of formats for a given reader, the reader will interpret only those formats and ignore formats that are not selected.

- Click **Submit Changes**.
- If you want to create a new card format, click the **New Format** button to display an empty Card Format Data Layout screen. Use the field descriptions given in the following table to define the layout and click **Save**.



**Note:** To disable a field, enter "--" in the Start Bit box and "0" in the Num Bits box.

**Table 2-5:** Configuration > Doors > Reader > Card Format Fields

Setting	Description
Name	Displays the name by which the format will be listed in the Card Formats tab. The name is user-defined.
Reverse Bit Order	Returns the message from the reader in reverse bit order (least significant bit first and most significant bit last).
Concatenated Site Code	Combines the Site Code and Card ID as one unique number.
Total Num Bits	Lists the total number of bits on the card.
Even Parity	Lists where on the card that even parity is being observed. <b>Start Bit</b> – first bit in the card where even parity begins. <b>Num Bits</b> – Number of bits to the right of the start bit, including the start bit, to include in the even parity check.
Odd Parity	Lists where on the card that odd parity is being observed. <b>Start Bit</b> – first bit in the card where odd parity begins. <b>Num Bits</b> – Number of bits to the right of the start bit, including the start bit, to include in the odd parity check.
CID A	Lists where on the card the Card ID A is listed. <b>Start Bit</b> – first bit in the card where card ID begins. <b>Num Bits</b> – Number of bits to the right of the start bit, including the start bit, that comprise the card ID. Most formats require only CID A, and not CID B, C, or D.

**Table 2-5:** Configuration > Doors > Reader > Card Format Fields (continued)

Setting	Description
CID B	Lists where on the card the Card ID B is listed. <b>Start Bit</b> – first bit in the card where card ID begins. <b>Num Bits</b> – Number of bits to the right of the start bit, including the start bit, that comprise the card ID. Most formats require only CID A, and not CID B, C, or D.
Card ID C	Lists where on the card the Card ID C is listed. <b>Start Bit</b> – first bit in the card where card ID begins. <b>Num Bits</b> – Number of bits to the right of the start bit, including the start bit, that comprise the card ID. Most formats require only CID A, and not CID B, C, or D.
Card ID D	Lists where on the card the Card ID D is listed. <b>Start Bit</b> – first bit in the card where card ID begins. <b>Num Bits</b> – Number of bits to the right of the start bit, including the start bit, that comprise the card ID. Most formats require only CID A, and not CID B, C, or D.
Site Code A	Lists where on the card the Site Code A is listed. Consult the card manufacturer for detail on the card detail. <b>Start Bit</b> – first bit in the card where the card’s Site Code begins. <b>Num Bits</b> – Number of bits to the right of the start bit, including the start bit, that comprise the Site Code. Most card formats require only Site Code A.
Site Code B	Lists where on the card the Site Code A is listed. Consult the card manufacturer for detail on the card detail. <b>Start Bit</b> – first bit in the card where the card’s Site Code begins. <b>Num Bits</b> – Number of bits to the right of the start bit, including the start bit, that comprise the Site Code. Most card formats require only Site Code A.
Site Code C	Lists where on the card the Site Code A is listed. Consult the card manufacturer for detail on the card detail. <b>Start Bit</b> – first bit in the card where the card’s Site Code begins. <b>Num Bits</b> – Number of bits to the right of the start bit, including the start bit, that comprise the Site Code. Most card formats require only Site Code A.

**Table 2-5:** Configuration > Doors > Reader > Card Format Fields (continued)

Setting	Description
Site Code D	<p>Lists where on the card the Site Code A is listed. Consult the card manufacturer for detail on the card detail.</p> <p><b>Start Bit</b> – first bit in the card where the card’s Site Code begins.</p> <p><b>Num Bits</b> – Number of bits to the right of the start bit, including the start bit, that comprise the Site Code.</p> <p>Most card formats require only Site Code A.</p>
Issue Code	<p>Lists where on the card the Issue Code A is listed.</p> <p><b>Start Bit</b> – first bit in the card where the card’s Issue Code begins.</p> <p><b>Num Bits</b> – Number of bits to the right of the start bit, including the start bit, that comprise the Issue Code.</p> <p>Most cards do not contain an Issue Code.</p>

6. If you want to change an existing card format’s data layout, double-click the format’s name on the list of existing formats to display the Card Format Data Layout screen. Use the descriptions in the table above to edit the layout’s fields. Then, click **Update** (to save in the format’s current name) or **Save as** (to save with a different format name) to save the edited format. To return to the default settings for the card format, click **Reset**. To delete the card format, click **Delete**.

## 2.4.2 Output Tab

An output, or output relay, is a switch on the panel that either energizes or de-energizes or pulses an output device, such as a door lock or a horn. For example, a successful card read at a reader (input device) causes the output relay switch on the panel board to change the normal state of a door lock (output device), so that the normally-locked door strike releases and permits entry. This tab configures the output relays.

Click the **Output** tab:

*Figure 2-11: Configuration > Doors > Output Tab*

Door 1 Output: 1	
Name	Output #1
Pulse Time	0 Hrs 0 Mins 10.0 Secs
Time Zones	Energized: Time Zone 1
	Disable Interlock: Time Zone 3
Latching	<input checked="" type="checkbox"/> Enable
Interlock	<input type="checkbox"/> Disabled
Keep On	<input checked="" type="checkbox"/> Enabled
Snow Day	<input type="checkbox"/> Enable
First Card Rule	<input checked="" type="checkbox"/> Enable

### The Output tab enables you to:

- Configure the following for each of the door's output devices:
  - Name
  - Pulse time
  - Time zones
  - Latching
  - Interlock
  - Keep on
  - Snow day
  - First card rule

**Steps:** Use the descriptions in the following table to configure each output device:

**Table 2-6:** Configuration > Doors > Output Tab Field Descriptions

Setting	Description
Name	Enter a unique name to identify the device.
Pulse Time	Specifies the duration for which the device will assume abnormal status. For example, it specifies how long a horn will blow or a door strike will remain released. Enter the desired number of hours (1024 maximum), minutes (60 maximum), and seconds (60 maximum). The sum of all three units comprises the pulse time. Note that you can express seconds in tenths of a second.
Time Zones	Specifies two schedules: <ul style="list-style-type: none"> <li>• <b>Energized</b> – sets the period during which the output switches are automatically energized.</li> <li>• <b>Disable Interlock</b> – sets the period during which the interlock, or a programmed interaction between selected inputs and outputs will be disabled.</li> </ul>
Latching	When selected, this locks a relay (either Normally Open or Normally Closed) to lock into place until it is reset either manually or by a signal
Interlock	Enables you to disable the interlock, or programmed interaction between this output device and an input device.
Keep On	Keeps the selected input shunted or the selected output (or output group) energized for the duration of its time zone.
Snow Day	Requires, like the First Card Rule, a valid card read before the time zone (period in which doors are unlocked) can take effect. Unlike the First Card Rule, however, the user can swipe the card a second time to return the doors to a locked state. For example, the principal of a school opens the school with a valid card read, and then closes the school with another card swipe when a storm arises. The time zone does not become active at its normal time. Note that both Snow Day and First Card Rule cannot be enabled at the same time.

**Table 2-6:** Configuration > Doors > Output Tab Field Descriptions (continued)

Setting	Description
First Card Rule	Requires a valid card read before the time zone (period in which doors are unlocked) can take effect. For example, the principal of a school would normally open the school with a valid card read, and the time zone becomes active at its normal time. When the school is cancelled due to a storm, the principal stays home, the doors are not opened, and the time zone does not become active at its normal time. Note that both Snow Day and First Card Rule cannot be enabled at the same time.

### 2.4.3 Inputs Tab

Three inputs are associated with each of the four doors on a NetAXS™ panel:

- Status – Provides the following door status information:
  - Normal – Reports that the door’s state is currently in its normal state, either Normally Open or Normally Closed.
  - Alarm – Reports that the door’s state is currently in its abnormal state: if the door is configured as Normally Open, its abnormal state is to be closed; if the door is configured as Normally Closed, its abnormal state is to be open.
  - Shorted (supervised input only) – Reports that the electrical circuit supporting the door and its devices has been short-circuited.
  - Cut (supervised input only) – Reports that the electrical circuit supporting the door has been cut or disconnected.
- Egress – Allows the door to open or close normally without generating an alarm.
- Tamper – Reports abnormal handling of the reader device or wiring.



Click to display the **Inputs** tab:

**Figure 2-12:** Configuration > Doors > Inputs Tab

[Status](#)   [Egress](#)   [Tamper](#)

<b>Name</b>	Input #2		Input 2
<b>Mode</b>	<input checked="" type="radio"/> Normally Closed		
	<input type="radio"/> Normally Open		
	<input checked="" type="radio"/> Unsupervised		
	<input type="radio"/> Supervised		
<b>Shunt Time</b>	0 Hrs	0 Mins	15.0 Secs
<b>Debounce Time</b>	0.0 Seconds		
<b>Time Zones</b>	Shunt: -		
	Disable Interlock: -		
	Disable Alarm Msgs: -		
<b>Auto-Relock</b>	<input type="checkbox"/> Disable	Output	1

Note that there are four possible Mode configurations. Shown in the screen above is the Normally Closed/Unsupervised Mode. The following screens show the remaining modes:

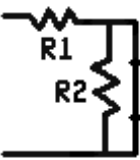
<b>Mode</b>	<input checked="" type="radio"/> Normally Closed		
	<input type="radio"/> Normally Open		
	<input type="radio"/> Unsupervised		
	<input checked="" type="radio"/> Supervised		
	R1 & R2 Values:		2.2k

Mode	<input type="radio"/> Normally Closed		
	<input checked="" type="radio"/> Normally Open		
	<input checked="" type="radio"/> Unsupervised		
	<input type="radio"/> Supervised		

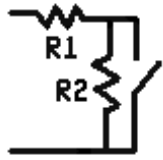
Mode	<input type="radio"/> Normally Closed	R1 & R2 Values: <input type="text" value="2.2k"/>	
	<input checked="" type="radio"/> Normally Open		
	<input type="radio"/> Unsupervised		
	<input checked="" type="radio"/> Supervised		

**The Inputs tab enables you to:**

- Define the Status, Egress, and Tamper inputs' access modes.
- Specify the Status, Egress, and Tamper shunt time, or the period of time the door's normal state will be ignored.
- Specify the Status, Egress, and Tamper debounce time, or the period of time the input must remain in its new state before it is recognized as being in the new state.
- Specify the time zones for the Status, Egress, and Tamper inputs.
- Enable or disable Auto-Relock for the Status inputs.

**Steps:** Use the descriptions in the table below to configure the Status, Egress, and Tamper inputs, then click **Submit Changes**:

*Table 2-7: Configuration > Doors > Inputs Tab Field Descriptions*

Setting	Description
Mode	<p><b>Normally Closed</b> – Specifies that the door’s normal state is closed.</p> <p><b>Normally Open</b> – Specifies that the door’s normal state is open.</p> <p><b>Unsupervised</b> – Specifies that the door’s electrical circuit is wired in one path without alternative paths supervised by resistors.</p> <p><b>Supervised</b> – Specifies that the door’s electrical circuit is wired with alternative paths supervised by resistors.</p> <p><b>R1 &amp; R2 Values</b> – Specifies the resistor values being used in the supervised modes. The default is 2.2K.</p>
Shunt Time	Specifies the amount of time for which the inputs will be shunted, or de-activated. For example, it specifies how long a door strike will remain released. Enter the desired number of hours (1024 maximum), minutes (60 maximum), and seconds (60 maximum). The sum of all three units comprises the shunt time. Note that you can express seconds in tenths of a second.
Time Zones	<p><b>Shunt</b> – Specifies the time period during which the input will be ignored.</p> <p><b>Disable Interlock</b> – Specifies the time period during which the programmed action on this input from another point will be disabled.</p> <p><b>Disable Alarm Msgs</b> – Specifies the time period during which Alarm and Normal will not be reported, but Short and Cut will be reported.</p>
Auto-Relock	Causes the door to re-lock immediately when the door status switch closes after entry. The output relay that controls the door strike de-energizes when the associated input returns to normal state instead of remaining energized for the duration of the pulse time. To enable Auto-Relock, de-select the <b>Disable</b> checkbox, and select the associated output from the drop down list.

## 2.5 Configuring Access Levels

Every card is assigned an access level. The access level specifies the time zone, or time schedule, during which the card holder can be granted access at a specific door. For example, an access level embedded in an employee's card might allow the employee to enter the facility only through door 2 from 6:00 a.m. to 6:00 p.m., Monday through Friday.

This section explains how to create the access levels that subsequently can be assigned to cards.



**Note:** Since an access level is defined by door and time zone configurations, you must configure the door (see “[Configuring the Doors](#)” on page 21) and the time zone (see “[Configuring Time Management](#)” on page 15) before configuring an access level.

Click **Access Levels** to display the Access Level Configuration screen:

*Figure 2-13: Configuration > Access Levels*

---

### Access Level Configuration

Readers from other panels may be added to an existing Access Level by selecting the desired panel, choosing its reader(s) and clicking 'Modify'

Panel 1	<input checked="" type="checkbox"/> Door 1	<input type="checkbox"/> Door 2	<input type="checkbox"/> Door 3	<input checked="" type="checkbox"/> Door 4
---------	--	---------------------------------	---------------------------------	--

Level	Name	Time Zone	Other Panels with Readers in This Level
1 ▾	Administrator	Default Time Zone (24x7) ▾	

New Level	Modify	Delete
-----------	--------	--------

---

**The Access Levels screen enables you to:**

- Create an access level.
- Modify an access level.
- Delete an access level.

**Steps to create an access level:**

1. Select the door(s). The access level will allow access only at the door(s) you select here.
2. Enter the name of the access level in the **Name** field. This should be a unique name that identifies the general user group.
3. Select the time zone you want from the drop down list in the **Time Zone** field. The access level will allow access to the card holder only during this time zone.
4. Click the **Add Level** button.

**Steps to modify an access level:**

1. From the drop down list in the Level field, select the number of the access level you want to modify.
2. Make the desired modifications.
3. Click the **Modify** button.

**Steps to delete an access level:**

1. Select the number of the access level you want to delete from the drop down list in the **Level** field.
2. Click the **Delete** button.
3. Click **OK** at the prompt to delete the access level.

## 2.6 Maintaining Cards

A card is a plastic card about the size of a credit card that is encoded with a unique number and the card holder's rights to access NetAXS™ system resources. For example, in addition to its unique number, a card would allow the card holder to be granted access to certain doors during a certain time of day.

### 2.6.1 Adding New Cards

Click **Cards > Add Card(s)** to display the Add New Card(s) screen:

*Figure 2-14: Cards > Add Cards*

**Add New Card(s)**

<b>Card Number(s)</b>	Single Add: <input type="text" value="118"/> Bulk Add: from <input type="text"/> to <input type="text"/>
<b>Card Holder Name</b>	Last: <input type="text" value="Kline"/> First: <input type="text" value="Randy"/>
<b>Card Type</b>	<input checked="" type="radio"/> Supervisor <input type="radio"/> Employee <input type="checkbox"/> VIP <input type="checkbox"/> Temp
<b>Issue Number</b>	<input type="text" value="2"/>
<b>PIN</b>	<input type="text" value="1024"/>
<b>Site Code</b>	<input type="text" value="Milwaukee (3)"/>
<b>Trace</b>	<input checked="" type="checkbox"/> Enable
<b>Expiration Date</b>	- / - / -
<b>Use Limits</b>	(disabled via <a href="#">System Configuration</a> )
<b>Department *</b>	<input type="text"/>
<b>Note2: *</b>	<input type="text"/>

\* This heading configurable via [System Configuration - General](#)

**Access Levels**

**Selected**

Administrator  
Employee

▼

▲

**Available**

Service

**The Add New Card(s) screen enables you to:**

- Create cards encoded with the following information:
  - Card number(s)
  - Card holder name (first and last names)
  - Card type
  - Issue number
  - Personal Identification Number (PIN)

- Site Code
- Trace capability
- Expiration date
- Use limits
- Card holder note 1
- Card holder note 2
- Access levels

**Steps:**

Use the field descriptions in the following table to complete the card fields and click **Add Card(s)**:

*Table 2-8: Cards > Add Cards Field Descriptions*

<b>Field</b>	<b>Description</b>
Card Number(s)	Specifies the unique number by which the card holder will be identified. A card number is required.
Card Holder Name	Identifies the card holder. A card holder first and last name is required. Each name can have up to 25 characters.
Card Type	Specifies whether the card holder is a supervisor, employee, a VIP, or a temporary employee (Temp). Note that the Temp box is active when the panel is configured for visitor cards in Configuration > System > General (see “ <a href="#">General Tab</a> ” on page 3). A card type is required.
Issue Number	Specifies the number of times this card number has been issued to the card holder. For example, a card holder may lose his original card having an issue number of 1. You would issue him a replacement with the same card number but with an issue number of 2. An issue number is required. The maximum issue number is 99.
PIN	Specifies the Personal Identification Number (PIN) for the card holder. A PIN is optional; however, if the door reader is configured to require PIN identification (see “ <a href="#">Reader Tab</a> ” on page 21), then you must create a PIN for the card holder here. The PIN number has a maximum of six digits.
Site Code	Specifies a unique code that identifies the card holder’s site. This setting is optional.
Trace	Sends an alarm message to the alarm monitor whenever a card with trace enabled is presented at a reader. This feature provides a trace of the cardholder’s path through the facility.

**Table 2-8:** Cards > Add Cards Field Descriptions (continued)

Field	Description
Expiration Date	Specifies the date that a visitor’s card is de-activated. A visitor’s card is one that is configured in Configuration > System > General Tab (see “ <a href="#">General Tab</a> “ on page 3) with the Use Limits field set to <b>Visitor Cards (limited days)</b> . Note that this field is active only when the Temp box is checked in the Card Type field.
Use Limits	Specifies the number of times or the number of days a card may be read at a card reader to which it has valid access. A panel is configured with one of three card use settings at Configuration > System > General Tab (see “ <a href="#">General Tab</a> “ on page 3): <b>Visitor Cards (limited days)</b> – Specifies a card for a visitor that can be used only a limited number of days. The specified period begins at the time the card is created. <b>Limited-Use Cards</b> – Specifies a card that can be used only a limited number of times. <b>Neither</b> – Specifies all cards other than visitor or limited-use cards. If the panel is configured with Visitor Cards (limited days), the Use Limits field accepts a number of days. If the panel is configured with Limited-Use Cards, the Use Limits field accepts a number of uses.
Note 1	Provides a user-defined field. See <a href="#">Configuring the System, page 3</a> for information about how this field is defined for the Add New Card template.
Note 2	Provides a user-defined field. See <a href="#">Configuring the System, page 3</a> for information about how this field is defined for the Add New Card template.
Access Level	Specifies the time zone, or time schedule, during which the card holder can be granted access at a specific door.



## 2.6.2 Displaying and Modifying Cards

Use this function to display specified cards and modify them.

Click **Cards > Card Data** to display the search screen with which you can find and display specified cards.

*Figure 2-15: Cards > Card Data*

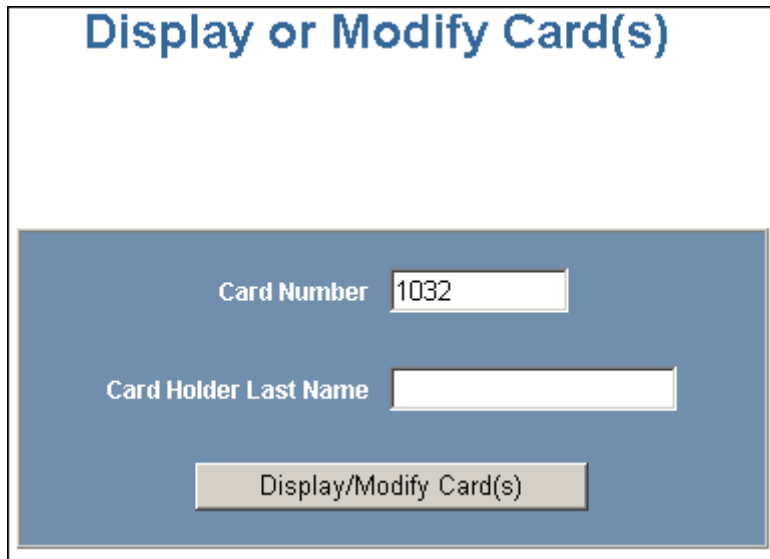

The screenshot shows a web form titled "Display or Modify Card(s)" in blue text. The form has a blue background and contains two input fields: "Card Number" with the value "1032" and "Card Holder Last Name" which is empty. Below the fields is a button labeled "Display/Modify Card(s)".

### The Display or Modify Card(s) screen enables you to:

- Display cards by searching on any of the following keys:
  - Card number
  - Card holder's last name
- Modify the displayed card(s)

### Steps:

1. Enter a value for either of the search keys (card number or cardholder last name).
2. Click the **Display/Modify Card(s)** button. The cards specified in step 1 appear.
3. Use the field descriptions given in the table in "[Adding New Cards](#)" on page 36 to complete the card fields and click **Submit Modification(s)**:

## 2.6.3 Deleting Cards

Click **Cards > Delete Card(s)** to display the Delete Cards screen:

*Figure 2-16: Cards > Delete Cards*

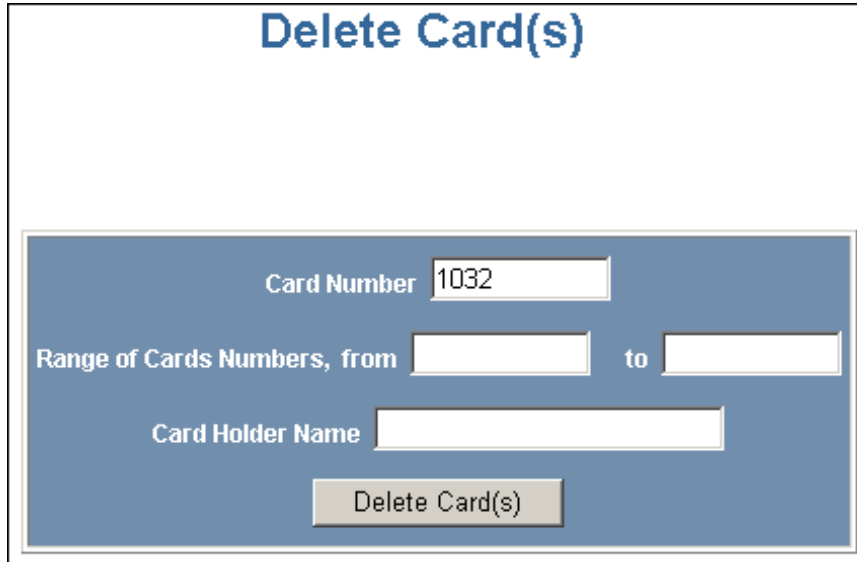

The screenshot shows a web form titled "Delete Card(s)" in blue text. The form has a dark blue background and contains the following elements:

- A text input field labeled "Card Number" with the value "1032" entered.
- A text input field labeled "Range of Cards Numbers, from" followed by a "to" label and another text input field.
- A text input field labeled "Card Holder Name".
- A button labeled "Delete Card(s)" at the bottom center.

### The Delete Card(s) screen enables you to:

- Delete cards retrieved by any of the following keys:
  - Card number
  - Range of card numbers
  - Card holder's last name

### Steps:

1. Enter a value for any of the search keys (card number, card number range, or cardholder name).
2. Click **Delete Card(s)** to delete all cards matching the search keys you entered.
3. Click **OK** at the prompt to delete the card.

## 2.6.4 Displaying Reports

Use this function to display a report of all cards and card data. You can display the cards either by the cardholder's last name or by the card number.

Click **Cards > Reports** to display the Card Reports screen.

### The Card Reports screen enables you to:

- View card records by the cardholder's last name.
- View card records by the cards' numbers.

### Steps:

1. Click the By Name tab to display the card records by the cardholders' last names.
2. Click the By Number tab to display the card records by the cards' numbers.
3. Use the descriptions given in the following table to read the card records (see "[Adding New Cards](#)" on page 36 for more information about card data):

**Table 2-9:** Cards > Reports Field Descriptions

Field	Description
Last	Shows the cardholder's last name.
First	Shows the cardholder's first name.
Card Number	Shows the card number.
Site	Shows the Site Code number. A Site Code is a user-configured name that identifies the site, or location, of the cardholder's access. See " <a href="#">Site Codes Tab</a> " on page 9 for more information about Site Codes. To determine the Site Code name associated with the Site Code number, click <b>Configuration &gt; System &gt; Site Codes</b> to display the Site Codes tab.
PIN	Shows the Personal Identification Number (PIN) for the card holder. The PIN number has a maximum of six digits.
Access Level	Shows the access level(s) configured for the cardholder. An access level specifies the time zone, or time schedule, during which the card holder can be granted access at a specific door. See " <a href="#">Configuring Access Levels</a> " on page 34 for more information about access levels. To determine an access level's defined hours, click <b>Configuration &gt; Access Levels</b> to display the Access Level Configuration screen.

**Table 2-9:** Cards > Reports Field Descriptions (continued)

Field	Description
Type	Shows the card type. The card type specifies whether the card holder is configured as a supervisor (Supr), employee (Empl), temporary employee (Temp), a VIP (VIP), or a combination of these types.
Tmp	Indicates (with a check mark) that the card is a temporary card.

## 2.7 Configuring Other I/O & Groups Tab

The NetAXS™ panel provides up to 14 inputs and eight outputs. Two of the inputs and four of the outputs are “other” inputs and outputs, because you can use them for other than door lock/unlock functions. This section explains how to configure these other inputs, outputs, and groups (for pulse and time zone).

### 2.7.1 Inputs Tab

This tab enables you to configure inputs 13 (AC Power Fail) and 14 (Panel Tamper) on Terminal Block 8, and the inputs on downstream MIRO boards daisy-chained to Terminal Block 10. The downstream inputs are numbered 25-96.



**Note:** The NetAXS™ panel supports two MIRO types:

- 32/0 – Provides 32 inputs and no outputs.
- 2/16 – Provides two inputs and 16 outputs.

A NetAXS™ panel supports a maximum of six daisy-chained MIROs – two 32/0 boards and four 2/16 boards. A MIRO-32/0 module has 32 supervised, four-state inputs that are limited to 2,200 ohms resistance. The MIRO-2/16 has two supervised inputs and 16 SPDT relay outputs; each input is limited to 2,200 ohms resistance. Each board is configured with a unique address in the Configuration > System > Downstream Devices tab (see “[Downstream Devices Tab](#)“ on page 11).

On panels with internal power supply, the Power Fail input generates an alarm when primary power is lost as indicated by the power supply. The Panel Tamper input generates an alarm when the NetAXS™ cabinet has been forced open. The Downstream inputs are available for general use.



**Note:** You can also configure the Power Fail and the Panel Tamper inputs for general use, if you choose not to wire them for power and tamper detection.

Click **Inputs** to display the Inputs screen. The Power Fail input box appears:

**Figure 2-17:** Configuration > Other I/O & Groups > Inputs Tab > Powerfail

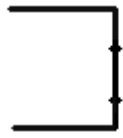
<b>Name</b>	PowerFail <b>Input 13</b>		
<b>Mode</b>	<input checked="" type="radio"/> Normally Closed		
	<input type="radio"/> Normally Open		
	<input checked="" type="radio"/> Unsupervised		
	<input type="radio"/> Supervised		
<b>Debounce Time</b>	<input type="text" value="0.0"/> Seconds		
<b>Time Zones</b>	Shunt: -	<input type="text" value="-"/>	
	Disable Interlock: -	<input type="text" value="-"/>	
	Disable Alarm Msgs: -	<input type="text" value="-"/>	

Click **Panel Tamper** to display the Panel Tamper screen:

**Figure 2-18:** Configuration > Other I/O & Groups > Inputs Tab > PanelTamper

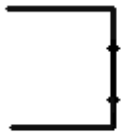
<b>Name</b>	PanelTamper <b>Input 14</b>		
<b>Mode</b>	<input checked="" type="radio"/> Normally Closed		
	<input type="radio"/> Normally Open		
	<input checked="" type="radio"/> Unsupervised		
	<input type="radio"/> Supervised		
<b>Debounce Time</b>	<input type="text" value="0.0"/> Seconds		
<b>Time Zones</b>	Shunt: -	<input type="text" value="-"/>	
	Disable Interlock: -	<input type="text" value="-"/>	
	Disable Alarm Msgs: -	<input type="text" value="-"/>	

Click **Downstream** to display the Downstream Input screen:

**Figure 2-19:** Configuration > Other I/O & Groups > Inputs Tab > Downstream

Downstream Input 25	
Name	Input #25
Mode	<input checked="" type="radio"/> Normally Closed <input type="radio"/> Normally Open
	<input checked="" type="radio"/> 2 state <input type="radio"/> 4 state
Shunt Time	0 Hrs 0 Mins 0.0 Secs
Debounce Time	0.0 Seconds
Time Zones	Shunt: -
	Disable Interlock: -
	Disable Alarm Msgs: -
Auto-Relock	<input checked="" type="checkbox"/> Disable

Submit Changes

**The Input tab enables you to:**

- Configure the mode, debounce time, and time zones for the Power Fail input (input 13).
- Configure the mode, debounce time, and time zones for the Panel Tamper input (input 14).
- Configure the mode, shunt time, debounce time, time zones, and auto-relock for the downstream inputs provided by downstream MIRO boards.

**Steps:** Use the descriptions in the following table to configure the Power Fail, Panel Tamper, and downstream inputs:

**Table 2-10:** *Configuration > Other I/O & Groups > Inputs Tab Field Descriptions*

Setting	Description
Name	Enter a unique name to identify the device.
Mode	<p><b>Normally Closed</b> – Specifies that the door’s normal state is closed.</p> <p><b>Normally Open</b> – Specifies that the door’s normal state is open.</p> <p><b>Unsupervised</b> – Specifies that the door’s electrical circuit is wired in one path without alternative paths supervised by resistors.</p> <p><b>Supervised</b> – Specifies that the door’s electrical circuit is wired with alternative paths supervised by resistors.</p>
Shunt Time	Specifies the amount of time for which the inputs will be shunted, or de-activated. For example, it specifies how long a door strike will remain released. Enter the desired number of hours (1024 maximum), minutes (60 maximum), and seconds (60 maximum). The sum of all three units comprises the shunt time. Note that you can express seconds in tenths of a second.
Debounce Time	Specifies the period of time the input must remain in a new state before generating an alarm. For example, if a Normal state is changed to Alarm, the state must remain in Alarm for five seconds before an alarm is generated.
Time Zones	<p><b>Shunt</b> – Specifies the time period during which the input will be energized.</p> <p><b>Disable Interlock</b> – Specifies the time period during which the programmed action on this input from another point will be disabled.</p> <p><b>Disable Alarm Msgs</b> – Specifies the time period during which the input will generate no alarms.</p>
Auto-Relock	Causes the door to re-lock immediately when the door status switch closes after entry. The output relay that controls the door strike de-energizes when the associated input returns to normal state instead of remaining energized for the duration of the pulse time. To enable Auto-Relock, de-select the <b>Disable</b> checkbox, and select the associated output from the drop down list.

## 2.7.2 Outputs Tab

This tab enables you to configure the four NetAXS™ auxiliary outputs (outputs 5-8) that are physically located on the panel board, and the outputs on downstream 2/16 MIRO boards daisy-chained to Terminal Block 10. A NetAXS™ panel supports a maximum of four 2/16 MIRO boards, and each board provides two inputs and 16 outputs. The downstream outputs are numbered 17-81.

Click **Outputs** to display the Auxiliary Output screen for the on-board outputs:

**Figure 2-20:** Configuration > Other I/O & Groups > Outputs Tab

On Board
Downstream

Auxiliary Output <span style="float: right;">5 ▾</span>	
Name	Output #5
Pulse Time	<input type="text" value="0"/> Hrs <input type="text" value="0"/> Mins <input type="text" value="0.0"/> Secs
Time Zones	Energized: <input type="text" value="Time Zone 1"/> ▾ Disable Interlock: <input type="text" value="Time Zone 3"/> ▾
Latching	<input checked="" type="checkbox"/> Enable
Interlock	<input type="checkbox"/> Disabled
Keep On	<input type="checkbox"/> Enabled
Snow Day	<input checked="" type="checkbox"/> Enable
First Card Rule	<input checked="" type="checkbox"/> Enable



Click **Downstream** to display the Downstream Output screen:

**Figure 2-21:** Configuration > Other I/O & Groups > Outputs Tab > Downstream

Downstream Output 17	
Name	Output #17
Pulse Time	0 Hrs 0 Mins 0.0 Secs
Time Zones	Energized: Time Zone 1
	Disable Interlock: Time Zone 3
Latching	<input checked="" type="checkbox"/> Enable

Submit Changes

**The Outputs tab enables you to:**

- Configure the following for each of the auxiliary outputs -- on board the panel as well as downstream:
  - Name
  - Pulse time
  - Time zones
  - Latching
  - Interlock
  - Keep on
  - Snow day
  - First card rule

**Steps:** Use the descriptions in the following table to configure each output device:

**Table 2-11:** *Configuration > Other I/O & Groups > Outputs Tab > Fields*

<b>Setting</b>	<b>Description</b>
Name	Enter a unique name to identify the device.
Pulse Time	Specifies the duration for which the device will assume abnormal status. For example, it specifies how long a horn will blow or a door strike will remain released. Enter the desired number of hours (1024 maximum), minutes (60 maximum), and seconds (60 maximum). The sum of all three units comprises the pulse time. Note that you can express seconds in tenths of a second.
Time Zones	Specifies two schedules: <ul style="list-style-type: none"> <li>• <b>Energized</b> – Sets the period during which the output switches are automatically energized.</li> <li>• <b>Disable Interlock</b> – Sets the period during which the interlock, or a programmed interaction between selected inputs and outputs will be disabled.</li> </ul>
Latching	When selected, this locks a relay (either Normally Open or Normally Closed) to lock into place until it is reset either manually or by a signal.
Interlock	Enables you to disable the interlock, or programmed interaction between this output device and an input device.
Keep On	Keeps the selected input shunted or the selected output (or output group) energized for the duration of its time zone.
Snow Day	Requires, like the First Card Rule, a valid card read before the time zone (period in which doors are unlocked) can take effect. Unlike the First Card Rule, however, the user can swipe the card a second time to return the doors to a locked state. For example, the principal of a school opens the school with a valid card read, and then closes the school with another card swipe when a storm arises. The time zone does not become active at its normal time. Note that both Snow Day and First Card Rule cannot be enabled at the same time.

**Table 2-11:** Configuration > Other I/O & Groups > Outputs Tab > Fields (continued)

Setting	Description
First Card Rule	Requires a valid card read before the time zone (period in which doors are unlocked) can take effect. For example, the principal of a school would normally open the school with a valid card read, and the time zone becomes active at its normal time. When the school is cancelled due to a storm, the principal stays home, the doors are not opened, and the time zone does not become active at its normal time. Note that both Snow Day and First Card Rule cannot be enabled at the same time.

### 2.7.3 Groups Tab

This tab enables you to configure outputs in groups. For example, you might want a group of horns in your facility to sound for the same duration or to be enabled or disabled according to the same schedule, or time zone. You might want a group of doors to be energized or de-energized during the same time zone. A NetAXS™ web server supports up to 64 output groups.

Click **Groups** to display the Groups screen:

**Figure 2-22:** Configuration > Other I/O & Groups > Groups Tab

Group	Name	Pulse Time	Energized TZ	Interlock Disabled TZ	Latch
new	<input type="text"/>	<input type="text"/> H <input type="text"/> M <input type="text"/> S	<input type="text"/>	<input type="text"/>	<input type="checkbox"/>

The screenshot shows the Groups Tab interface. On the left, under "Available Outputs", there is a list of Output 1 through Output 7, each with a selection arrow. Below this list are "Select All" and "Select None" buttons. In the center, there is a "New Group" section with an "Add Group" button. On the right, under "Selected Outputs", there is a list containing "< none >". Below this list are "Select All" and "Select None" buttons. Green double arrow buttons are positioned between the Available and Selected sections.

**The Groups tab enables you to:**

- Associate any of the panel's eight output relays in one or more groups.
- Configure the following for each group:
  - Pulse Time
  - Energized TZ (Time Zone)
  - Interlock Disabled TZ (Time Zone)
  - Latch

**Steps:** Use the descriptions in the following table to configure each group:

**Table 2-12:** Configuration > Other I/O & Groups > Groups Tab Field Descriptions

Setting	Description
Name	Enter a unique name to identify the group.
Pulse Time	Specifies the duration for which the device will assume abnormal status. For example, it specifies how long a horn will blow or a door strike will remain released. Enter the desired number of hours (1024 maximum), minutes (60 maximum), and seconds (60 maximum). The sum of all three units comprises the pulse time. Note that you can express seconds in tenths of a second.
Energized TZ	Specifies the period during which the group of output relays are automatically energized.
Interlock Disabled TZ	Specifies the period during which the interlocks that control the group's outputs will be disabled.
Latch	Toggles the state of the outputs between energized and de-energized status upon every activation (code use, interlock, or manual pulse).

## 2.8 Configuring Interlocks

An interlock is a programmed connection between two points. The interlock causes an input point, output point, or group of output points to act in a specified manner when another input point, output point, or group of output points changes its state. An action on one point cause a reaction from a second point on the same panel or attached MIRO board. For example, when a motion detector (input) detects movement, it causes a horn (output) to sound.

Click **Interlocks** to display the Interlocks Configuration screen:

*Figure 2-23: Configuration > Interlocks*

### Interlocks Configuration - Panel 1

Int Lk	Name	Trigger	Reacting Component	Alarm Action	Normal Action
1	Input 1	Input 1	Output 1 <span>Disable</span>	Pulse On	No action
3	Input 3	Input 3	Output 2 <span>Disable</span>	Pulse On	No action
5	Input 5	Input 5	Output 3 <span>Disable</span>	Pulse On	No action
7	Input 7	Input 7	Output 4 <span>Disable</span>	Pulse On	No action
97	Rdr 1 to Grp 1	Output 1	Group 1 <span>Disable</span>	Follow	Follow
98	Door #2 Shunt	Output 2	Input 4 <span>Disable</span>	Follow	Follow
99	Door #3 Shunt	Output 3	Input 6 <span>Disable</span>	Follow	Follow
100	Door #4 Shunt	Output 4	Input 8 <span>Disable</span>	Follow	Follow

Interlocks are defined by their trigger points. Adding an interlock with a trigger point used by an existing interlock will overwrite the existing interlock.

Name:

Trigger	Reacting Component	Reacting Component's Action
<input type="radio"/> Input Point <input checked="" type="radio"/> Output Point <span style="margin-left: 20px;">1 ▾</span> <input type="radio"/> Output Group	<input type="radio"/> Input Point <input type="radio"/> Output Point <span style="margin-left: 20px;">1 ▾</span> <input checked="" type="radio"/> Output Group	Upon Trigger Alarm: <span style="margin-left: 20px;">Follow ▾</span> Upon Trigger Normal: <span style="margin-left: 20px;">Follow ▾</span>
<input type="button" value="New Interlock"/>		<input type="button" value="Delete"/>

**The Interlocks screen enables you to:**

- Create, modify, and delete interlocks.
- Enable or disable existing interlocks.

**Steps to create an interlock:**

1. Click the **New Interlock** button to display the screen.
2. Use the descriptions in the following table to configure the interlock:

*Table 2-13: Configuration > Interlocks > Field Descriptions*

<b>Interlock element</b>	<b>Description</b>
Trigger	Specifies the input, output, or output group for which a change of state will cause a reaction from another input, output, or group. Also, use the drop down list to specify the number of the input, output, or group.
Reacting Component	Specifies the input, output, or output group that will react to a change of state from the trigger point. Also, use the drop down list to specify the number of the input, output, or group.
Reacting Component's Action	<b>Upon Trigger Alarm</b> – Specifies the reacting component's action when the trigger's change of state occurs. Select the action from the Upon Trigger Alarm drop down list. <b>Upon Trigger Normal</b> – Specifies the reacting component's action when the trigger's change of state occurs. Select the action from the Upon Trigger Normal drop down list.

3. Click the **Add Interlock** button to create the interlock.

**Steps to modify an interlock:**

1. In the Int Lk column, click the number of the interlock you want to modify.
2. Click the **New Interlock** button.
3. Use the descriptions in the table above to make the desired modifications in the empty Trigger, Reacting Component, and Reacting Component's Action fields for the selected interlock:
4. Click the **Add Interlock** button to complete the modification.

**Steps to delete an interlock:**

1. In the Int Lk column, click the number of the interlock you want to delete.
2. Click the **Delete Interlock** button to display the Delete Interlock screen, and click **OK** to complete the deletion.

**Steps to enable/disable an interlock:**

1. To enable an interlock, click the **Enable** button.
2. To disable an interlock, click the **Disable** button.

## 2.9 Configuring Users

A user is one who will be using the NetAXS™ software interface in one or more of the following functional roles:

- Administrator – Configures the NetAXS™ system.
- Service – Provides diagnostic and support service for the NetAXS™ system.
- Operator – Monitors the system’s operation.

Click **Users** to display the User Configuration screen:

*Figure 2-24: Configuration > Users*

### User Configuration - Panel 1

User Name	Account Type	State	Status
admin	Administrator	Enabled	Logged In
Mark Wayford	Service	Enabled	Logged Out
Rhonda Luerson	Service	Enabled	Logged Out
Cynthia Parks	Service	Enabled	Logged Out
Blaine Freeney	Operator	Enabled	Logged Out
Crandall Morin	Operator	Enabled	Logged Out
Scot Landley	Operator	Enabled	Logged Out
Rhona Liu	Service	Enabled	Logged Out

**Name:**       **Password:**

**Account Type:**    Administrator    Service    Operator

**Account Status:**    Enabled    Disabled

---

**The User Configuration screen enables you to:**

- Create a user.
- Modify a user.
- Delete a user.
- Enable and disable a user account.
- View the user’s current login status, either logged in or logged out.



**Steps to create a user:**

1. Click the **New User** button.
2. Enter the user's name in the **Name** field (at least five characters).
3. Enter a unique password in the **Password** field (at least five characters). Note that a duplicate password will not be accepted.
4. Select the type in the **Account Type** field.
5. Select the Account Status:
  - Enabled – Activates the user account (the user can log in).
  - Disabled – De-activates the user account (the user cannot log in).
6. Click the **Add User** button.

**Steps to modify a user:**

1. In the **User Name** field, click the name of the user you want to modify.
2. Change the name, password, account type, or account status.
3. Click the **Modify** button.

**Steps to delete a user:**

1. In the User Name column, click the user account you want to delete.
2. Click the **Delete** button.
3. Click **OK** at the prompt to delete the user account.



---

# Configuring via WIN-PAK

# 3

---

Overview	3-1
Adding a New NetAXS™ Panel	3-2

## 3.1 Overview

This chapter explains the NetAXS™ configuration functions as accessed via the Quick Start Wizard (QSW) in WIN-PAK 2005, WIN-PAK PRO 2005, WIN-PAK SE, and WIN-PAK PE. The QSW creates the ADV options and adds the panel to the Control Map and the Master Access Level.

These functions should be performed only by the NetAXS™ system administrator or service personnel.



### Notes:

- WIN-PAK 2.0, release 4, uses the same steps provided in this chapter to configure NetAXS™; however, its screens are not exactly the same.
- NetAXS™ cannot be added to WIN-PAK PRO Release 4 or older.
- For a new Site installation, or for adding to an existing Site, follow the procedures in this chapter as you would when you add an N-1000-IV-X panel. One exception to this is that the NetAXS™ panel does not support the use of the C-100-A1 (20ma current loop installations). Therefore, when you select the Loop type, 485 AC<-NAK is the only supported type. Direct is reserved for NS2P; C-100 is not supported.
- If the NetAXS™ panel is configured as a Gateway panel, it appears to WIN-PAK as an N-485-PCI or N-485-HUB. Using the NetAXS panel as a Gateway, you should not add N-1000/PW-2000 panels as a downstream panel to the NetAXS Gateway. The NetAXS Gateway is designed for more efficient downstream communications than what can be supported by the N-1000/PW2000 panels.

The NetAXW Gateway panel's baud rate is set configured via the NetAXS web server (see the *NetAXS Access Control Unit Installation Guide* for instructions). When you set the Loop Type in the QSW to 485 ACK-NAK, you define the baud rate to be 19.2 kilobits per second. This baud rate and the panel's baud rate must match to communicate properly. For WIN-PAK SE or WIN-PAK PE systems, you can adjust the baud rate of the N-485 device to 115 kilobits per second for optimum performance.

## 3.2 Adding a New NetAXS™ Panel

To add a NetAXS panel, first create the panel in the WIN-PAK Quick Start Wizard, and then complete the configuration manually with the WIN-PAK Panel Configuration screen.

### 3.2.1 Creating the Panel with Quick Start Wizard

Add a new panel by selecting its Loop and configuring the following from the Quick Start Wizard Panel screen:

- Panel type (Select N1000-4X/PW2000-4X from the dropdown list)
- Panel name (Loop[Loop number]-Panel [Panel address])
- Panel address (Select from the dropdown list)

*Figure 3-1: Quick Start Wizard - Panel Screen*



**Note:** Each panel on a communication loop must have a unique address. The address must correspond with the address that is set by DIP switches on the panel.

After adding the NetAXS panel via the QSW, you must update the Reader and Input interlocks to match them with the default wiring of the NetAXS panel. Proceed to [“Configuring the Panel Manually”](#) on page 3 and make the necessary changes.

## 3.2.2 Configuring the Panel Manually

Use the WIN-PAK Panel Configuration screen to complete the NetAXS panel configuration manually. All of the configuration screen options are supported for NetAXS panel configuration, except where they are noted otherwise in this section.

If you are using the Device Map to add the NetAXS panel manually, add it as you would an N-1000-IV-X panel.

1. Display the Basic tab of the WIN-PAK Panel Configuration screen. The Name, Description, and Type fields contain the entries selected in the Quick Start Wizard:

**Figure 3-2:** WIN-PAK Panel Configuration Screen - Basic Tab

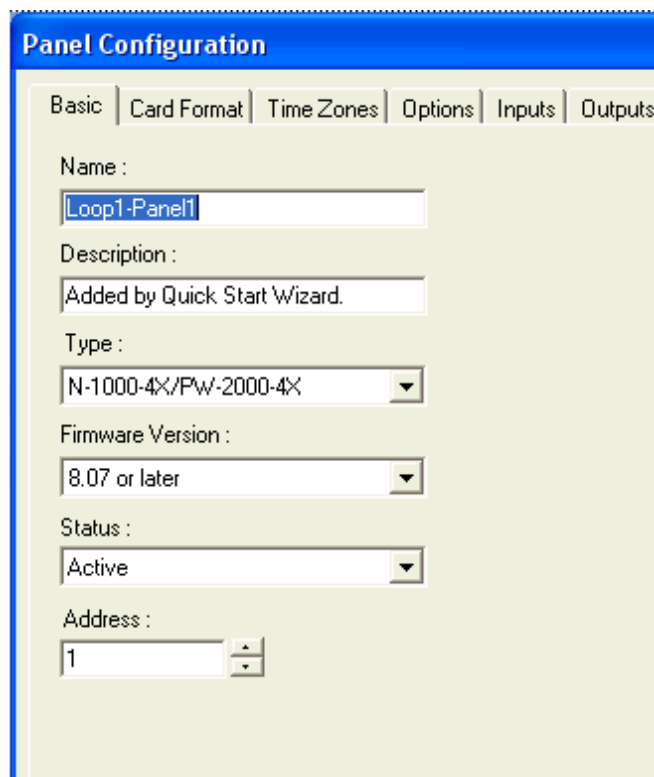

The screenshot shows the 'Panel Configuration' window with the 'Basic' tab selected. The fields are as follows:

- Name: Loop1-Panel1
- Description: Added by Quick Start Wizard.
- Type: N-1000-4X/PW-2000-4X
- Firmware Version: 8.07 or later
- Status: Active
- Address: 1

2. Enter the following selections for the remaining fields:
  - Firmware version – 8.07 or later.
  - Status – Active.
  - Address – Select the appropriate panel number.

- 3. Click **OK**.
- 4. Display and complete the Card Format tab:

**Figure 3-3:** WIN-PAK Panel Configuration Screen - Card Format Tab

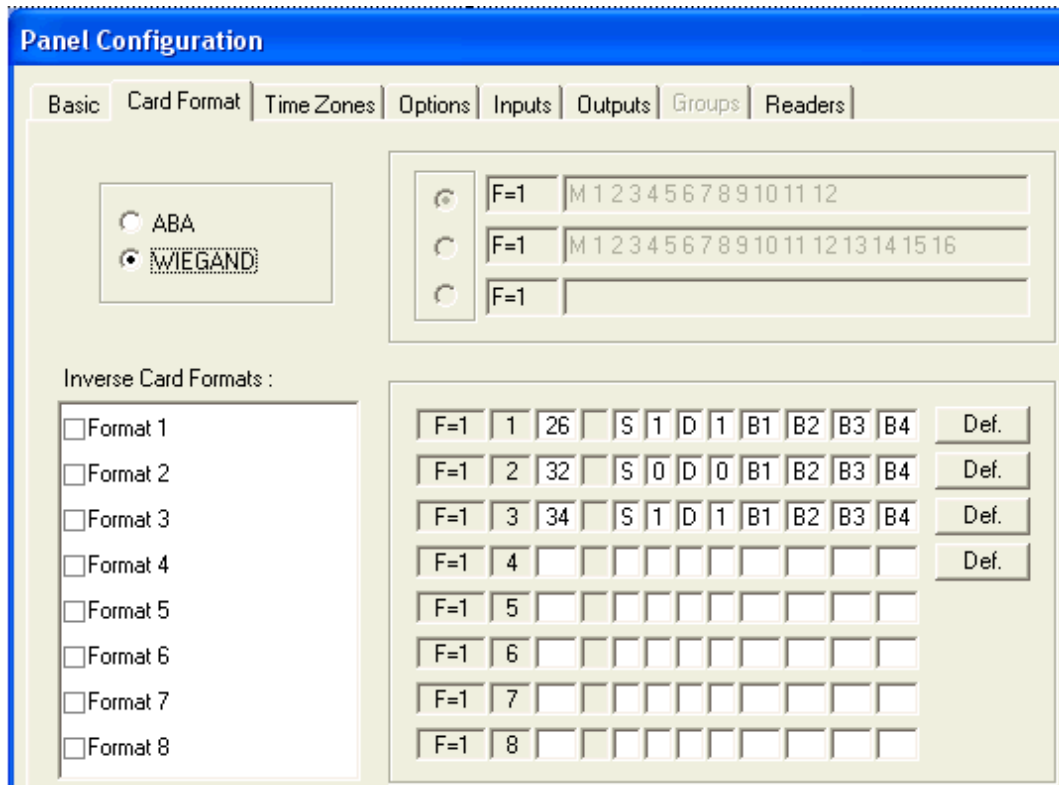

5. Display and complete the Time Zones tab:

**Figure 3-4:** WIN-PAK Panel Configuration Screen - Time Zones Tab

Available Time Zone	Description	No. Slots
8:00am-5:00pm M-F	8:00am-5:00pm Monday-Friday (excl. ...	1
4:00pm-12:00am M-F	4:00pm-12:00am Monday-Friday (excl....	1
12:00am-8:00am M-F	12:00am-8:00am Monday-Friday (excl....	1
6:00am-7:00pm x 7 days	6:00am-7:00pm 7 days per week (incl....	1

Slot	Selected Time Zone	Description	No. Slots
1	Always On	This Timezone is always on	1
2	Never On	This Timezone is never on	1

Holiday Group :



**Note:** All Time Zones and Holidays are supported for a NetAXS panel.

6. Display and complete the Options tab:

Figure 3-5: WIN-PAK Panel Configuration Screen - Options Tab

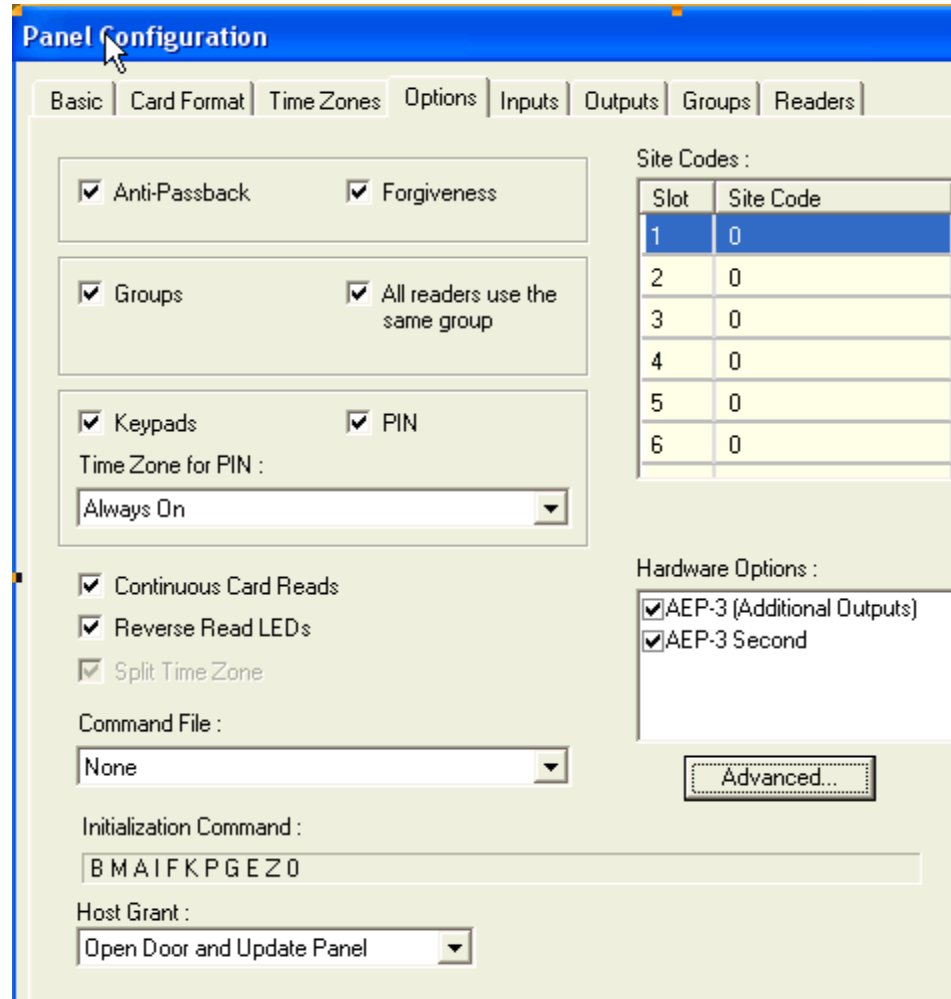

**Notes:**

- All options are supported for a NetAXS panel except the Advanced U option. When using Groups, you must select both AEP boards in the Hardware Options box. The NX4OUT board functions as two AEP-3 boards, and it provides outputs 17-32.
- You can select Keypads; however, the NetAXS panel does not support the matrixed keypads (for example, KP-10, KP-12, or PR-PROXPRO-K2). The supported readers include the PR-PROXPRO-K (HU/5355AGK000 and OT35xx and OT36xx series readers and keypads).



7. Click the **Advanced** button to display the Advanced Options screen, and select the desired advanced options. Note that the Advanced U option is not supported for the NetAXS panel.

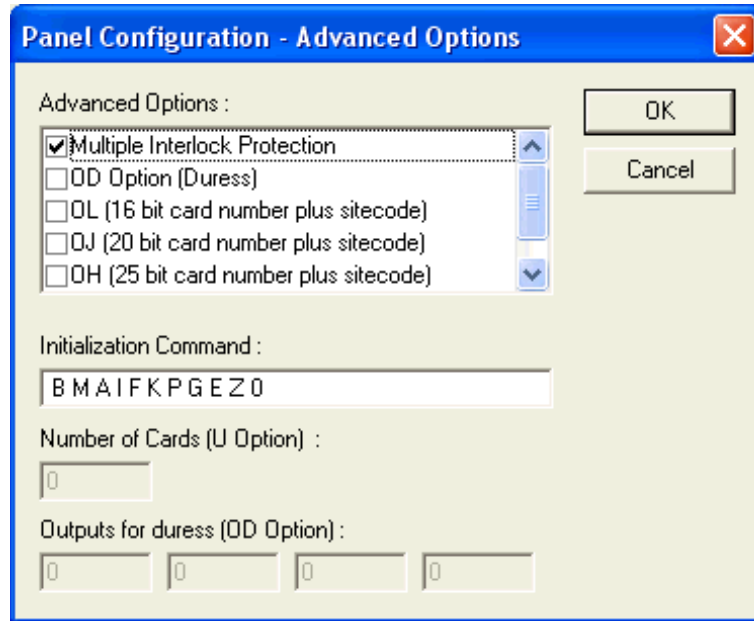

8. Display and complete the Inputs tab. If you are using the NetAXS inputs to monitor the door status or activate a request to exit, then you must reassign the interlocks as indicated below. If you are not using panel inputs for door status or egress, you only need to dissolve the interlocks. Note that if you do not dissolve the default N-1000-IV interlocks, an error will occur during NetAXS panel initializations.

All Inputs tab functions are available to NetAXS configuration. However, not all inputs are available and their default functions have changed. NetAXS supports inputs 1-14. The default functions are listed below. Their default values are assumed to be zero, unless otherwise noted. You must change the interlocking.

9. Use the following procedure to reassign the interlocks:
  - a. Display the Readers tab, and then display the first input's configuration window. Select **None**, and click **OK**. This dissolves all input interlocks and changes the Shunt Time to 0. This allows the input to be properly redefined for use with NetAXS.

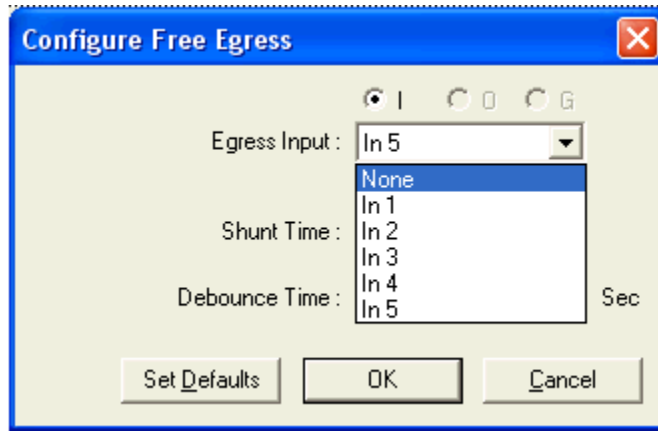

- b. Repeat the preceding step for each input for each reader on this tab.
- c. After all interlocks on all inputs for each reader have been dissolved, reassign the interlocks according to [Table 3-1](#) below:

**Table 3-1: Interlock Reassignments for NetAXSs™**

Interlock	Function
1	Door egress for Door 1
2	Door status switch for Door 1. Shunt time is 15 seconds.
3	Door egress for Door 2.
4	Door status switch for Door 2. Shunt time is 15 seconds.
5	Door egress for Door 3.
65	Door status switch for Door 3. Shunt time is 15 seconds.
7	Door egress for Door 4.
8	Door status switch for Door 4. Shunt time is 15 seconds.
9	Reader 1 tamper/auxiliary.
10	Reader 2 tamper/auxiliary.

**Table 3-1: Interlock Reassignments for NetAXSs™ (continued)**

Interlock	Function
11	Reader 3 tamper/auxiliary.
12	Reader 4 tamper/auxiliary.
13	Primary power status - external (or General input). There is also a system primary power alarm 17 that reports through the ADV and is not a wired port.
14	Tamper (or General input).

The screen captures shown below show the configuration for the default interlocking for a single door:

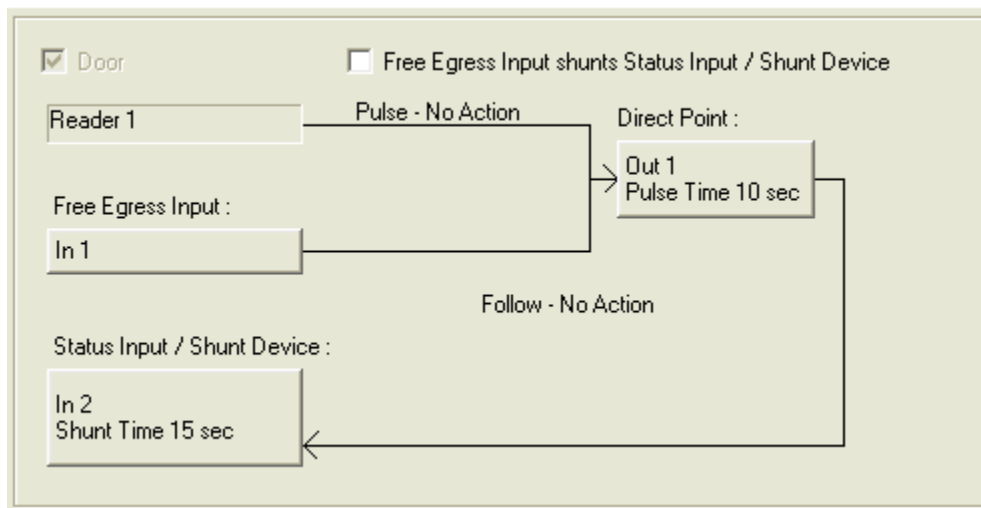

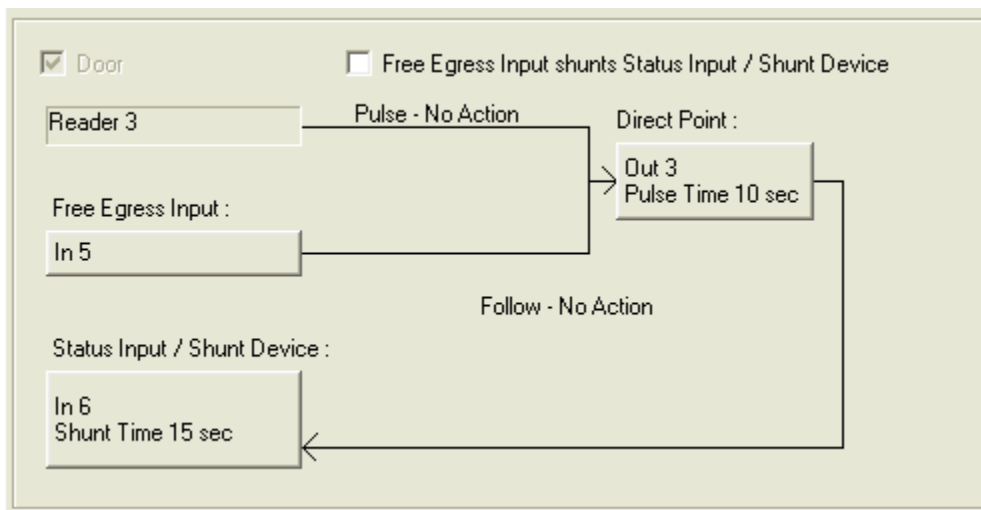
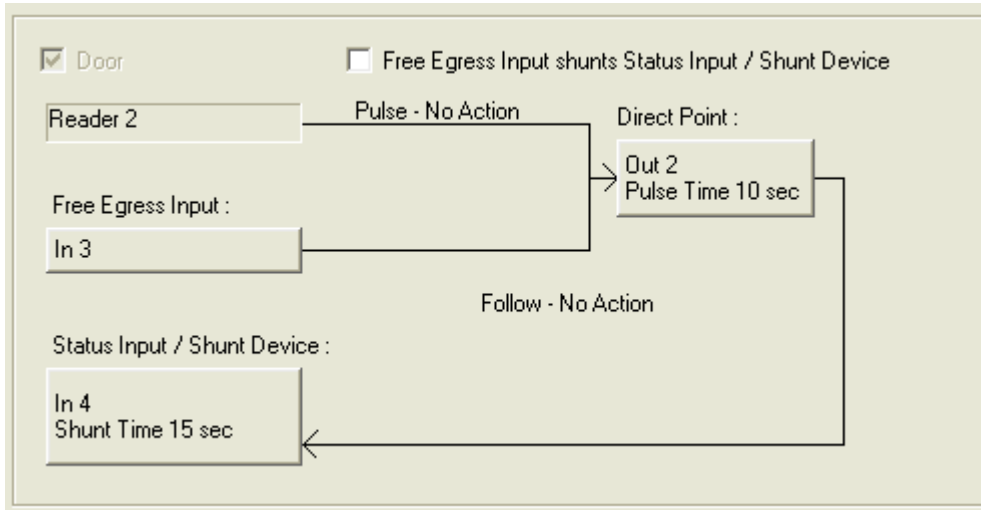

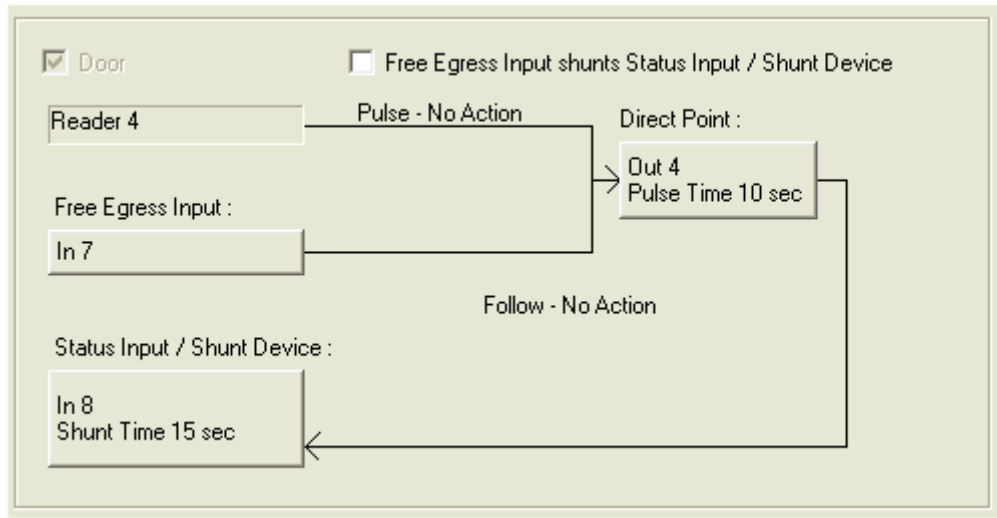

10. The configuration of a NetAXS panel via WIN-PAK is now complete. No configuration is necessary on the Outputs and Groups tabs.



**Note:** You cannot initialize the NetAXS panel from the WIN-PAK Control Map.



---

# Monitoring NetAXS™ Status



# 4

---

Overview	4-1
Monitoring Alarms	4-2
Monitoring Events	4-5
Monitoring Inputs	4-7
Monitoring Outputs	4-10
Monitoring System Status	4-12

## 4.1 Overview

This chapter is written for the NetAXS™ operator who will monitor the following NetAXS™ status:

- Alarms – Alarms are events, or system transactions, that have been assigned alarm status. These often include events such as an invalid card read or a forced door.
- Events – Events are the recorded transactions of the NetAXS™ system. For example, an event card found, number of users logged in.
- Inputs – Inputs are terminals located on the NetAXS™ panel; the inputs are wired to input points, such as a card reader, elsewhere in the NetAXS™ system.
- Outputs – Output relays are switches located on the NetAXS™ panel that are connected to output devices, such as a door lock, elsewhere in the NetAXS™ system.
- System – This includes status for other NetAXS™ system objects.

## 4.2 Monitoring Alarms

Alarms are viewed as system-generated messages that may indicate the need for user attention.



**Note:** From the drop down menu at the upper-right corner of each Alarms tab, you can configure the tab to display alarms in groups of 10, 25, 50, or 75.

Click **Status > Alarms** to display the New Alarms tab:

*Figure 4-1: Status > Alarms > New Tab*

### Alarms - Panel 1

**New** Acknowledged2407 New AlarmsMax Alarms Displayed: 25

Select / De-select All Displayed

Ack	Date/Time [ID]	Device Name [ID]	LN	PN	Code	Credential	Card Holder Name
<input type="checkbox"/>	4/17/2007 12:21:34	Input#20	20	0	Normal State		
<input type="checkbox"/>	4/17/2007 12:21:34	Input#14	14	14	Normal State		
<input type="checkbox"/>	4/17/2007 12:21:34	Input#13	13	13	Normal State		
<input type="checkbox"/>	4/17/2007 12:21:34	Input#12	12	12	Normal State		
<input type="checkbox"/>	4/17/2007 12:21:34	Input#11	11	11	Normal State		
<input type="checkbox"/>	4/17/2007 12:21:34	Input#8	8	8	Normal State		
<input type="checkbox"/>	4/17/2007 12:21:34	Input#7	7	7	Normal State		
<input type="checkbox"/>	4/17/2007 12:21:34	Input#6	6	6	Normal State		
<input type="checkbox"/>	4/17/2007 12:21:34	Input#5	5	5	Normal State		
<input type="checkbox"/>	4/17/2007 12:21:34	Input#4	4	4	Normal State		
<input type="checkbox"/>	4/17/2007 12:21:34	Input#3	3	3	Normal State		
<input type="checkbox"/>	4/17/2007 12:21:34	Input#10	10	10	Normal State		
<input type="checkbox"/>	4/17/2007 12:21:34	Input#9	9	9	Normal State		
<input type="checkbox"/>	4/17/2007 12:21:34	Input#2	2	2	Normal State		
<input type="checkbox"/>	4/17/2007 12:21:34	Input#1	1	1	Normal State		

OldestOlderAcknowledge Selected AlarmsNewest



Click the **Acknowledged** tab to display the acknowledged alarms:

**Figure 4-2:** Status > Alarms > Acknowledged Tab

Date/Time [ID]	Device Name [ID]	LN	PN	Code	Cred.PIN-Site	Card Holder Name
3/10/2001 05:32:36	Input #20	20	0	Alarm State		
3/10/2001 05:32:36	Input #14	14	14	Alarm State		
3/10/2001 05:32:36	Input #13	13	13	Alarm State		
3/10/2001 05:32:36	Input #12	12	12	Alarm State		
3/10/2001 05:32:36	Input #11	11	11	Alarm State		
3/10/2001 05:32:36	Input #10	10	10	Alarm State		
3/10/2001 04:46:42	Reader Record #1	1	1	Card Not Found	20410	
3/7/2001 08:18:00	Input #1	1	1	Alarm State		
3/7/2001 08:17:59	Input #1	1	1	Normal State		
2/28/2001 05:26:36	Input #1	1	1	Normal State		
2/27/2001 06:07:43	Input #8	8	8	Ajar State		
2/27/2001 06:07:43	Input #6	6	6	Ajar State		
2/27/2001 06:07:43	Input #4	4	4	Ajar State		
2/27/2001 06:07:43	Input #2	2	2	Ajar State		
2/27/2001 06:07:43	Input #10	10	0	Alarm State		

The following table describes the information displayed on both the New alarms tab and Acknowledged alarms tab:

**Table 4-1:** Status > Alarms Field Descriptions

Column Head	Description
Ack (New tab only)	Enables you to select any or all of the alarms that you want to acknowledge. Note that acknowledging an alarm simply means that you acknowledge that the alarm exists; an acknowledgement does not mean action has been taken. To acknowledge an alarm, select the check box and click the <b>Acknowledge Selected Alarms</b> button. Note that you can select or de-select all of the alarms by selecting or de-selecting the Select/De-select All Displayed check box.
Date/Time [ID]	Provides the date and exact time the alarm was generated according to the panel's time.
Device Name [ID]	Identifies the device that generated the alarm.

*Table 4-1: Status > Alarms Field Descriptions (continued)*

Column Head	Description
LN	<b>Logical device number</b> – the unique name or number given to the alarm-generating device when the device was configured in <b>Configuration &gt; Doors</b> .
PN	<b>Physical device number</b> – the unique number assigned to the device on the NetAXS™ board.
Code	Identifies the current state of the device that generated the alarm. For example, the possible states could include: <ul style="list-style-type: none"><li>• Normal State</li><li>• Alarm State</li><li>• Ajar State</li><li>• Card Found</li><li>• Card Not Found?</li></ul>
Credential	Identifies the card number.
Card Holder Name	Identifies the last name of the card holder who energized the input device when the alarm was generated.

**Note:** You can display the oldest alarms first by clicking **Oldest**, or display the newest alarms first by clicking **Newest**. Click **Older** to scroll through the list by displaying the next oldest tab display of alarms.

## 4.3 Monitoring Events

The Events page monitors both panel- and web-generated events. For example, a panel event is the reading of a card by a reader. A web event example is a user logon.

Click **Status > Events** to display the Panel event tab:

*Figure 4-3: Status > Events > Panel Tab*

Date/Time [ID]	Device Name [ID]	LN	PN	Code	Cred/PIN/Site	Card Holder Name
4/22/2001 02:59:51	Downstream #3 MRO 2/16	0	0	Online		
4/22/2001 02:42:46	Downstream #3 MRO 2/16	0	0	Online		
4/22/2001 02:30:28	Downstream #3 MRO 2/16	0	0	Online		
4/21/2001 06:19:10	Downstream #3 MRO 2/16	0	0	Online		
3/11/2001 06:36:12	Reader Record #1	1	1	Card Found	20410 195	Geiger
3/11/2001 06:35:12	Reader Record #1	1	1	Card Found	20410 195	Geiger
3/11/2001 06:34:24	Reader Record #1	1	1	Card Found	20410 195	Geiger
3/11/2001 06:34:12	Reader Record #1	1	1	Card Found	20410 195	Geiger
3/11/2001 06:33:53	Reader Record #1	1	1	Card Found	20410 195	Geiger
3/11/2001 06:33:21	Reader Record #1	1	1	Card Found	20410 195	Geiger
3/11/2001 06:32:59	Reader Record #1	1	1	Card Found	20410 195	Geiger
3/11/2001 06:32:27	Reader Record #1	1	1	Card Found	20410 195	Geiger
3/11/2001 06:32:16	Reader Record #1	1	1	Card Found	20410 195	Geiger
3/11/2001 06:31:24	Reader Record #1	1	1	Card Found	20410 195	Geiger
3/11/2001 06:31:00	Reader Record #1	1	1	Card Found	20410 195	Geiger

The following table describes the information displayed on the Panel events tab:

*Table 4-2: Status > Events > Panel Tab Field Descriptions*

Column Head	Description
Date/Time [ID]	Provides the date and exact time the event was generated, according to the panel's name.
Device Name [ID]	Identifies the device that generated the event.
LN	<b>Logical device number</b> – the unique name or number given to the event-generating device when the device was configured in <b>Configuration &gt; Doors</b> .

Table 4-2: Status > Events > Panel Tab Field Descriptions (continued)

Column Head	Description
PN	<b>Physical device number</b> – the unique number assigned to the device on the NetAXS™ board.
Code	Briefly describes the event.
Credential	Identifies the card number.
Card Holder Name	Identifies the last name of the card holder who energized the input device when the alarm was generated.

Click **Status > Events > Web** to display the Web events tab:

Figure 4-4: Status > Events > Web Tab

### Events - Panel 1

Panel **Web**

Active Users: 2 Events Displayed: 25 ▾

Date/Time	Description
5/ 2/2001 09:56:23	User 'admin' logged in with admin access [session Id: 0xc1ce3853]
4/22/2001 03:00:14	User 'admin' logged in with admin access [session Id: 0xbce4db01]
4/22/2001 02:44:46	User 'admin' logged in with admin access [session Id: 0x101d6ee1]
4/21/2001 06:06:46	User 'admin' logged in with admin access [session Id: 0xf2cf66ae]
4/21/2001 05:31:47	User 'admin' logged in with admin access [session Id: 0x9d1ce37f]
4/21/2001 01:43:55	User 'admin' logged in with admin access [session Id: 0x9e5c39f7]
4/14/2001 05:39:58	User 'admin' logged in with admin access [session Id: 0xa14ee46]
4/11/2001 08:29:00	User 'admin' logged in with admin access [session Id: 0xf5e25bc]
4/ 7/2001 08:40:47	User 'admin' logged in with admin access [session Id: 0x3368c8bb]
4/ 7/2001 02:19:12	User 'admin' logged in with admin access [session Id: 0x184e8fa0]
4/ 4/2001 03:03:01	User 'admin' logged in with admin access [session Id: 0x157219c9]
4/ 2/2001 01:57:07	User 'admin' logged in with admin access [session Id: 0x5fce2c6f]
4/ 2/2001 01:32:20	User 'admin' logged in with admin access [session Id: 0xa191ef74]

Oldest
Older
Newer
Newest



**Notes:**

- The number of active users is indicated in the upper left corner of the tab.
- You can display the oldest events first by clicking **Oldest** at the bottom of the tab, or display the newest events first by clicking **Newest**. Click **Older** to scroll through the list by displaying the next oldest tab display of events.

## 4.4 Monitoring Inputs

A NetAXS™ panel supports door, panel, and auxiliary inputs. The door inputs provide egress and tamper status, the panel inputs provide power fail and tamper status, and the auxiliary inputs support any downstream status.

Click **Status > Inputs** to display the Input Status screen:

*Figure 4-5: Status > Inputs*

**Input Status - Panel 1**  
Click input to manually shunt or unshunt

Door #1	Input #2 [2]	Normal	Restore to Time Zone
	Input #1 [1]	Alarm	Restore to Time Zone
	Input #9 [9]	Alarm	Restore to Time Zone
Door #2	Input #4 [4]	Alarm	Restore to Time Zone
	Input #3 [3]	Alarm	Restore to Time Zone
	Input #10 [10]	Alarm	Restore to Time Zone
Door #3	Input #6 [6]	Alarm	Restore to Time Zone
	Input #5 [5]	Alarm	Restore to Time Zone
	Input #11 [11]	Alarm	Restore to Time Zone
Door #4	Input #8 [8]	Alarm	Restore to Time Zone
	Input #7 [7]	Alarm	Restore to Time Zone
	Input #12 [12]	Alarm	Restore to Time Zone
Panel	Power Fail [13]	Alarm	Restore to Time Zone
	Tamper [14]	Alarm	Restore to Time Zone
Downstream #3	Input #89 [89]	Alarm	Restore to Time Zone

### The Input Status screen enables you to:

- View the current status of each input (Normal, Alarm, Trouble, Cut, Short, Shunted).
- Shunt or un-shunt any input. When an input is shunted, the alarm is de-activated. This is a way you can allow the input to grant access without falsely signalling an alarm. The default state of an input point is “un-shunted.”
- Restore the input to its configured time zone. A time zone is a specified time period during which the input will be shunted and the alarm de-activated. (see “[Configuring Time Management](#)“ on page 15).

**Steps:**

1. To shunt or un-shunt an input, click the input name to display a prompt. Click **OK** to complete the shunt or un-shunt.

## Input Status - Panel 1

Click input to manually shunt or unshunt

Door #1	Input #2 [2]	Normal	Restore to Time Zone
	Input #1 [1]	Alarm	Restore to Time Zone
	Input #9 [9]	Alarm	Restore to Time Zone
Door #2	Input #4 [4]	Alarm	Restore to Time Zone
	Input #3 [3]	Alarm	Restore to Time Zone
	Input #10 [10]	Alarm	Restore to Time Zone
Door #3	Input #6 [6]	Alarm	Restore to Time Zone
	Input #5 [5]	Alarm	Restore to Time Zone
	Input #11 [11]	Alarm	Restore to Time Zone
Door #4	Input #8 [8]	Alarm	Restore to Time Zone
	Input #7 [7]	Alarm	Restore to Time Zone
	Input #12 [12]	Alarm	Restore to Time Zone
Panel	Power Fail [13]	Alarm	Restore to Time Zone
	Tamper [14]	Alarm	Restore to Time Zone

Microsoft Internet Explorer

Unshunt input #4?

OK Cancel

- To restore the input to its shunt state based on its configured time zone, click the input's **Restore to Time Zone** button to display a prompt. Click **OK** to complete the restoration to the configured time zone.

## Input Status - Panel 1

Click input to manually shunt or unshunt

Door #1	Input #2 [2]	Normal	Restore to Time Zone
	Input #1 [1]	Alarm	Restore to Time Zone
	Input #9 [9]	Alarm	Restore to Time Zone
Door #2	Input #4 [4]	Alarm	Restore to Time Zone
	Input #3 [3]	Alarm	Restore to Time Zone
			Restore to Time Zone
Door #3			Restore to Time Zone
			Restore to Time Zone
			Restore to Time Zone
Door #4	Input #8 [8]	Alarm	Restore to Time Zone
	Input #7 [7]	Alarm	Restore to Time Zone
	Input #12 [12]	Alarm	Restore to Time Zone
Panel	Power Fail [13]	Alarm	Restore to Time Zone
	Tamper [14]	Alarm	Restore to Time Zone

Microsoft Internet Explorer

Restore input #4 to its current timezone?

OK Cancel

## 4.5 Monitoring Outputs

An output is an output device that changes its normal state when it is energized, pulsed, or time-zone controlled. For example, a successful card read at a reader pulses a door lock. The lock changes its normally locked state to an unlocked state and the cardholder opens the door.

A NetAXS™ panel supports one output for each of its four doors. The panel also supports four additional outputs for auxiliary devices and 64 downstream outputs. Outputs can be configured singly as discrete outputs (see “Output Tab” on page 28 and “Outputs Tab” on page 46) or collectively as a group of outputs (“Groups Tab” on page 49).

**Note:** The Pulse and Restore to Time Zone buttons will be greyed out if no outputs are attached.

Click **Status > Outputs** to display the Discrete tab of the Output Status screen:

*Figure 4-6: Status > Outputs > Discrete Tab*

Output Status - Panel 1				
Click output to toggle its state				
Door #1	Output #1 [1]	De-energized	Pulse	Restore to Time Zone
Door #2	Output #2 [2]	Energized	Pulse	Restore to Time Zone
Door #3	Output #3 [3]	De-energized	Pulse	Restore to Time Zone
Door #4	Output #4 [4]	De-energized	Pulse	Restore to Time Zone
Auxiliary	Output #5 [5]	De-energized	Pulse	Restore to Time Zone
	Output #6 [6]	De-energized	Pulse	Restore to Time Zone
	Output #7 [7]	De-energized	Pulse	Restore to Time Zone
	Output #8 [8]	De-energized	Pulse	Restore to Time Zone

*Figure 4-7: Status > Outputs > Groups Tab*

Click **Status > Outputs > Groups** to display the Groups tab of the Output Status screen:

Output Status - Panel 1				
Click Group to Toggle Its State				
Groups	Group 1	De-energized	Pulse	Restore to Time Zone
	Group 2	De-energized	Pulse	Restore to Time Zone
	Group 3	Energized	Pulse	Restore to Time Zone



**The Output Status tab enables you to:**

- View the current status of each output in the Discrete tab (Energized or De-energized).
- View the current status of each output group in the Groups tab.
- Energize or de-energize any output or group indefinitely.
- Pulse any output. This energizes the output or group for a configured period of time (see “[Output Tab](#)“ on page 28).
- Restore the output to its configured time zone. A time zone is a specified time period during which the output will be energized. (see “[Configuring Time Management](#)“ on page 15).

**Steps:**

1. To energize an output or group of outputs for an indefinite period of time, click the **De-energized** button to display a prompt. Click **OK** to complete the change to “Energized.”

To de-energize an output or group of outputs for an indefinite period of time, click the **Energized** button to display a prompt. Click **OK** to complete the change to “De-energized.”

2. To Pulse an output or group of outputs for the configured period of time, click the **Pulse** button to display a prompt. Click **OK** to start the pulse. Note that the Pulse button will be greyed out if no output is attached.
3. To re-set the output behavior according to its configured time zone, click the **Restore to Time Zone** button to display a prompt. Click **OK** to restore the time zone. Note that the Restore to Time Zone button will be greyed out if no output is attached.

## 4.6 Monitoring System Status

This feature provides basic monitoring of objects in the NetAXS™ system other than alarms, events, inputs, and outputs.

Click **Status > System** to display the System Status screen:

*Figure 4-8: Status > System*

### System Status - Panel 1

	Existing	Capacity
New Alarms	183	10000
Cards	7	10000
Card Formats	7	128
Time Zones	4	127
Access Levels	4	128
Holidays	5	255
Site Codes	0	8
Interlocks	248	256
Output Groups	3	64
Downstream Devices	0	6

**The System Status screen enables you to:**

View the following status of system objects other than alarms, events, inputs, and outputs:

- Number of currently configured instances of the object.
- Maximum number of object instances that can be configured.





---

# Index

## A

- Access level 2-34, 2-38
- Access mode 2-23
- Acknowledged alarms 4-3
- Administrator 2-54
- Alarms 4-1, 4-2
  - acknowledged 4-3
  - monitoring 4-2
- Anti-passback 2-4, 2-24
- Auto-relock 2-33, 2-45
- Auxiliary outputs 2-46

## B

- Baud rate
  - host 2-13
  - loop 2-14

## C

- Card and PIN duress detect 2-5
- Card formats 2-24
  - for WIN-PAK configuration 3-4
- Card use types 2-5
- Cardholder notes 2-4, 2-5
- Cards
  - access level 2-38
  - access levels 2-34
  - adding 2-36
  - card formats 2-24
  - card type 2-37
  - cardholder notes 2-4, 2-5
  - deleting 2-40
  - displaying 2-39

- issue number 2-37
- limited use 2-5
- modifying 2-39
- PIN 2-37
- reports 2-41
- site code 2-9, 2-37
- trace 2-37
- use limits 2-38
- use types 2-5
- visitor 2-5
- Communications
  - host baud rate 2-13
  - loop baud rate 2-14
  - port number 2-14
  - type 2-13
- Configuration database 2-6
- Configuration flow chart 2-2
- Configuration mode 2-12
- Configuration task sequence 2-2
- Continuous card reads 2-5
- Current time 2-15

## D

- Debounce time 2-45
- De-energizing 2-17
- Default gateway 2-8
- DIP switches
  - Gateway panel 1-2
  - MIRO boards 2-11
- Doors
  - anti-passback 2-24
  - auto-relock 2-33
  - egress 2-30
  - inputs 2-30
  - mode 2-31, 2-33
  - outputs 2-28

- readers 2-21
- shunt time 2-33
- status 2-30
- time zones 2-33

Downloading firmware 2-6

Downstream

- baud rate 2-14
- force baud reset 2-14
- inputs 2-42
- outputs 2-46

Downstream devices 2-11

Duress detect 2-5

## E

Egress 2-30

Energizing 2-17

Events 4-1, 4-5

## F

File management 2-6

Firmware

- downloading 2-6
- for WIN-PAK configuration 3-3
- reverting to previous 2-6

First card rule 2-30, 2-49

Force baud reset 2-14

## G

Gateway panel 1-2, 2-4

Groups 2-49

## H

Holidays (see also Time Zones) 2-19

Host 2-12

Host baud rate 2-13

Host connection 2-13

Host mode monitoring 2-12

## I

Inputs 2-30, 4-1

- AC Power Fail 2-42
- auto-relock 2-33, 2-45
- debounce time 2-45
- downstream 2-42
- for WIN-PAK configuration 3-7
- interlocks 2-51, 3-7
- MIRO boards 2-42
- mode 2-31, 2-33, 2-45
- monitoring 4-7
- Panel Tamper 2-42
- readers 2-21, 3-7
- shunt time 2-33, 2-45
- shunting 4-8
- time zones 2-33, 2-45

Interlocks 2-29, 2-48, 2-51

- for WIN-PAK configuration 3-7

IP address 2-8

Issue number 2-37

## K

Keep on 2-29, 2-48

## L

Latching 2-29, 2-48

LEDs 2-5

Limited-use cards 2-5

## M

MAC address 2-8

MIRO boards 2-11, 2-42, 2-46

Mode 2-31, 2-33, 2-45

Monitorable Input Relay Output boards, see MIRO boards 2-11

Monitoring alarms 4-2

Monitoring events 4-5

Monitoring inputs 4-7

Monitoring mode 2-12

Monitoring outputs 4-10

---

Monitoring status 2-12  
Monitoring system status 4-12

## N

Network configuration 2-8  
Normally closed 2-31, 2-33  
Normally open 2-32, 2-33

## O

Operator 2-54  
Output relay 2-28  
Outputs 2-28, 4-1

- auxiliary 2-46
- de-energizing 4-11
- downstream 2-11
- energizing 4-11
- first card rule 2-49
- groups 2-49
- interlock 2-48
- interlocks 2-51
- keep on 2-48
- latching 2-48
- MIRO boards 2-11
- monitoring 4-10
- pulsing 4-11
- re-setting 4-11
- snow day 2-48
- time zones 2-48

## P

Panel status 1-7  
Panels

- addresses 2-4
- configuring via WIN-PAK 3-2
- downstream baud rate 2-14
- gateway 2-4
- reboot 2-4
- reset 2-4
- setting current time 2-15

Personal Identification Number, see PIN 2-4  
PIN 2-4, 2-37

Port number 2-14  
Pulse time 2-29, 2-48

## Q

Quick Start Wizard 3-2

## R

R1 2-33  
R2 2-33  
Readers 2-21

- access mode 2-23
- anti-passback 2-24
- card formats 2-24
- LEDs 2-5
- tamper 2-30

Reports 2-41  
Resistor values 2-33

## S

Scheduling access 2-17  
Select panel 1-7  
Selecting panels 1-7  
Service user 2-54  
Setting current time 2-15  
Shunt time 2-33, 2-45  
Shunting inputs 4-8  
Site code 2-37  
Site codes 2-9  
Snow day 2-29, 2-48  
Status

- alarms 4-2
- events 4-5
- inputs 4-7
- outputs 4-10
- panels 1-7
- system 4-12

Subnet mask 2-8  
Supervised 2-31, 2-32, 2-33  
System status 4-12

## T

Tamper 2-30  
Time management 2-15  
Time synchronization (host and panel) 2-14  
Time zones 2-17, 2-29, 2-33, 2-34, 2-45, 2-48,  
4-11  
    for WIN-PAK configuration 3-5  
Timeout 2-4  
Trace 2-37  
Trigger 2-52

## U

Unsupervised 2-32, 2-33  
Uploading card and configuration data 2-6  
Use limits 2-38  
Users 2-54

## V

Visitor cards 2-5

## W

Web mode monitoring and configuring 2-12  
Web server 1-1  
Web server connection 1-2  
    direct 1-3  
    hub 1-2  
Web session timeout 2-4



**Honeywell Access Systems**

135 W. Forest Hill Avenue  
Oak Creek, WI 53154  
United States  
800-323-4576  
414-766-1798 Fax  
[www.honeywellaccess.com](http://www.honeywellaccess.com)

Specifications subject to change  
without notice.

© Honeywell. All rights reserved.  
Document 800-00233, Revision A

**Honeywell**