

Installation Guide Non-programmable H/C Controller

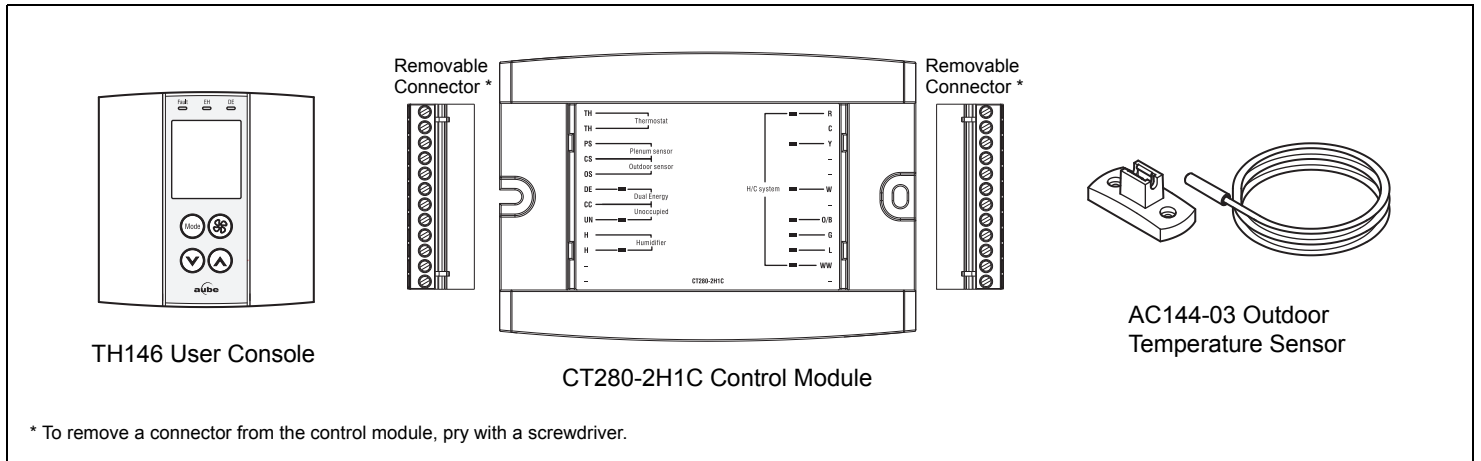

1. Introduction

1.1 Applications

The TH146-N-2H1C programmable controller can be used with any of the following heating/cooling systems:

- ▶ Heat pump - 1H1C, 2H1C
- ▶ HVAC - 1H, 1C, 1H1C

The following devices can be connected to the controller:

- ▶ air recirculation fan
- ▶ humidifier
- ▶ dual-register meter (dual energy)
- ▶ remote control device (for the unoccupied mode)

1.2 Supplied Parts

- CT280-2H1C control module
- TH146 console with two wall anchors and mounting screws
- AC144-03 outdoor temperature sensor (3 m or 10 ft) with mounting clip (see section 2.6)

1.3 Accessories

- RC845 relay (see section 2.4)
- AC146-410 plenum temperature sensor (see section 2.7)
- CT241 telephone controller (see section 2.9)

2. Installation

2.1 Control Module (CT280-2H1C)

Configure the control module according to your type of heating/cooling system using DIP switches on the back of the module.

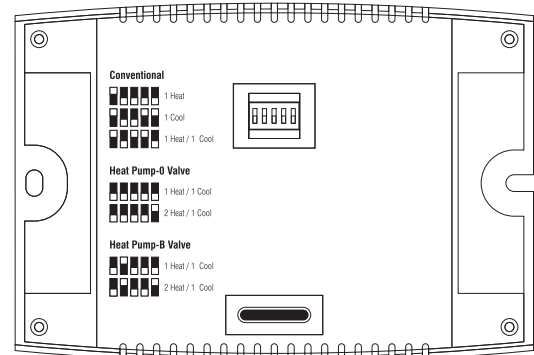

Install the control module near the heating/cooling system, away from any heat source.

2.2 User Console (TH146)

Install the console in a central location. Avoid locations with air drafts (e.g., top of staircase or air outlet) or stagnant air (behind a door). Do not install the console on a wall hiding air ducts nor expose it to direct sunlight.

NOTE: If this controller replaces an old thermostat, any two of the wires that were connected to the thermostat can be used to connect the user console to the control module. The maximum wiring length is 30 m (100 ft).

- ❶ Choose a location about 1.5 m (5 ft) above the floor on an inside wall.
- ❷ Loosen the captive screw under the console.
- ❸ Detach the console from its base by pulling the bottom section.
- ❹ Secure the base using the wall anchors and screws.
- ❺ Connect the console to controller terminals TH and TH (no polarity).

2.3 Heating/Cooling System

The terminals used to connect the heating/cooling system depend on the type of system. See the appropriate wiring table on page 4.

2.4 RC845 Relay

If you have an add-on installation, you might need an RC845 relay to connect the furnace (auxiliary heat) and its fan to the controller. Install the relay near the control module and connect the wires as follows:

- relay terminals W, G and C to controller terminals W1, G and C.
- relay terminals T and T to the appropriate furnace terminals: T and T (oil); TH and TH (gas); R and W (electric).

NOTE: Refer to the relay's installation instructions for more details.

2.5 Humidifier

Connect the humidifier in series with the power supply between controller terminals H and H (dry contact).

2.6 Outdoor Sensor (AC144-03)

The outdoor sensor is required for the following:

- outdoor temperature display
- balance points (heat pumps only, see section 4.2)
- defrost point (heat pumps only, see section 4.3)
- automatic humidity control (see section 5.5)

When installing the sensor, observe the following guidelines:

- Avoid locations where the sensor can be covered with snow or exposed to direct sunlight.
- Avoid air outlets and concealed chimneys or stove pipes.

Install the sensor using its mounting clip and connect it to controller terminals OS and CS (no polarity).

NOTE: The maximum wiring length is 30 m (100 ft).

2.7 Plenum Sensor (AC146-410)

The plenum sensor is required for the following:

- low temperature limit inside the plenum (HVAC only)
- high temperature limit inside the plenum (HVAC only)
- fan limit if gas heating is used (HVAC only)
- high pressure protection during defrost cycle (This protection is generally needed for add-on installations only. It is not needed if the heat pump is not connected to the controller terminal WW.)

Install the sensor on the side of the plenum and position it such that its aperture faces the air flow.

Connect the sensor to controller terminals PS and CS (no polarity). For more information, refer to the instructions provided with the sensor.

NOTE: The maximum wiring length is 30 m (100 ft).

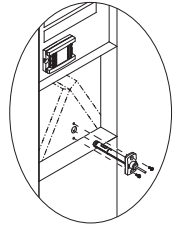

2.8 Dual-energy Input

NOTE: The dual-energy input can be used only with a heat pump equipped with auxiliary heat.

The dual-energy input can be connected to the dual-register meter equipped with a normally open (NO) dry contact. Connect the controller terminals DE and CC to the meter terminals (yellow and red wires).

The contact closes when the outdoor temperature drops below the temperature setting on the meter. When the contact is closed, the heat pump is disabled and only the auxiliary heat can be used.

2.9 Unoccupied Mode Input

To use the unoccupied mode, the controller requires a remote control device such as Aube's CT241 telephone controller equipped with a normally open (NO) dry contact placed between terminals UN and CC of the controller. The unoccupied mode is activated when the contact closes. (See section 5.6.)

3. Configuration

3.1 Configuration Switches

To access the configuration switches, loosen the captive screw under the console and separate the console from its base by pulling it from the bottom part.

3.1.1 Backlight (SW1-1)

BL ON: The screen is always backlit.

AUTO: The screen is backlit only when a button is pressed. The backlight remains on for 12 seconds.

3.1.2 Access Mode (SW1-2)

INST: Installer mode. Gives access to all configuration parameters.

NOTE: In installer mode, the short-cycle protection is disabled and the interstage delay is reduced to 1 minute.

USER: User mode. Gives access to configuration parameter 17 (humidity setpoint or humidity offset) only.

3.1.3 Keypad Lock (SW1-3)

I: The keypad is locked. Settings cannot be changed.

O: The keypad is unlocked.

3.2 Software Configuration

- 1 Place the console in Installer mode (INST) using the SW1-2 switch on the back of the console.
- 2 Press the **Mode** button for 3 seconds to access the configuration menu (see page 8). The first menu item (parameter) is displayed.
- 3 To view another menu item, briefly press the **Mode** button.
- 4 To modify a parameter, press either \odot button.
- 5 To exit the configuration menu, press \otimes .
- 6 Return the console to User mode (USER).

4. Principles of Operation

4.1 Automatic Heating/Cooling Changeover

With automatic heating/cooling mode changeover, there's no need to adjust the controller at every change of season or weather condition. The controller switches automatically between heating mode and cooling mode to maintain the desired temperature. The mode changeover is triggered as follows:

- The controller switches to cooling mode when the indoor temperature is higher than the setpoint by more than 1.5°C (2.5°F) for 15 minutes.
- The controller switches to heating mode when the indoor temperature is lower than the setpoint by more than 1.5°C (2.5°F) for 15 minutes.

4.2 Balance Points (heat pumps only)

Balance points are used to disable the heat pump or the auxiliary heating when the outdoor temperature is below or above a set temperature.

- When the outdoor temperature is below the balance point low (bP L), the heat pump is disabled and only auxiliary heating can be used (see page 8, item 2).
- When the outdoor temperature is above the balance point high (bP H), the auxiliary heat is disabled and only the heat pump can be used (see page 8, item 3).

NOTE: Balance Points cannot be used if the AC144-03 outdoor temperature sensor is not connected to the controller.

4.3 Heating During Defrost (heat pumps only)

The auxiliary heat is activated during defrost except under the following conditions:

- When the outdoor temperature is above the defrost point (see page 8, item 4). **Note:** This condition will not apply if the AC144-03 outdoor sensor is not connected to the controller.
- When the plenum temperature is above 40°C (104°F) for add-on installations only. The auxiliary heat is re-activated when the plenum temperature drops below 32°C (90°F). **Note:** This condition will not apply if the AC146-410 plenum sensor is not connected to the controller.

NOTE: The auxiliary heat's short-cycle protection is disabled during defrost.

4.4 Types of Heat Pump Installations

The controller can be configured for either of the following types of heat pump installations (see page 8, item 5).

- **Add-on Installation:** This type of installation is performed when adding a heat pump to an existing furnace. When the heat pump is installed, the furnace becomes the auxiliary heat source. In this type of installation, the indoor coils are usually installed downstream of the auxiliary heat source. When the controller is configured for an add-on installation, the heat pump is disabled during auxiliary heating to prevent overpressure.
- **New Installation:** In this type of installation, as there is not already a furnace, the auxiliary heat source is installed at the same time as the heat pump. In this type of installation, the indoor coils are located upstream of the auxiliary heat. When the controller is configured for a new installation, the heat pump and the auxiliary heat can operate simultaneously.

4.5 Interstage Delay

Interstage Delay is the time allocated for the temperature to return to an acceptable value when it deviates too far from the setpoint. If this time has elapsed, the next heating or cooling stage is activated. The heating or cooling stage will be deactivated when the temperature returns to an acceptable value. The Interstage Delay is fixed at 4 minutes if the controller is configured for an HVAC system and is user-adjustable if it is configured for a heat pump (see page 8, item 6).

4.6 Low and High Temperature Limits

Low Temperature Limit (LLMT) and High Temperature Limit (HLMT) are used to keep the plenum from becoming too cold or too hot. During cooling, if the plenum temperature is lower than LLMT, a cooling stage is deactivated starting with the one that was last activated. If, after a while, the temperature is still too low, another cooling stage is deactivated and so on. Likewise, during heating, if the plenum temperature is higher than HLMT, a heating stage is deactivated starting with the one that was last activated. If, after a while, the temperature is still too high, another heating stage is deactivated and so on. (see page 8, items 7 and 8.)

WARNING: LLMT and HLMT can be used in parallel with an UL353-approved device but they do not replace such device.

NOTE: LLMT and HLMT cannot be used if the plenum temperature sensor is not connected to the controller.

4.7 Smart Fan

When Smart Fan is enabled (see page 8, item 12), the fan operates as follows:

- During the unoccupied mode (i.e., when you are away from home), the fan operates only when heating or cooling is activated.
- The fan operates continuously the rest of the time.

NOTE: For Smart Fan to work, set the fan to On (see section 5.2).

Wiring Tables

Heat Pump			
Terminal	Device	1H1C	2H1C
TH	Console	Connect the console between the TH terminals (no polarity)	
TH			
PS	Plenum sensor	Connect the plenum sensor between the PS and CS terminals (no polarity)	
CS	Common S	Common terminal for the plenum sensor and the outdoor sensor	
OS	Outdoor sensor	Connect the outdoor sensor between the CS and OS terminals (no polarity)	
DE	Dual Energy	Connect the dual-register meter between the DE and CC terminals (no polarity)	
CC	Common C	Common terminal for the dual-energy meter and the unoccupied mode input	
UN	Unoccupied mode input	Connect a dry contact between the UN and CC terminals (no polarity)	
H	Humidifier (24 Vac / 1 A)	Connect the humidifier between the H terminals (dry contact)	
H			
R	Power (24 Vac)	√	√
C		√	√
Y	Compressor (24 Vac / 1 A)	√	√
W	Auxiliary heat (24 Vac / 1 A)		√
O/B	Reversing valve (24 Vac / 1 A)	√	√
G	Fan (24 Vac / 1A)	√	√
L	Fault (24 Vac / 5 mA)	√	√
WW	Defrost (24 Vac / 5 mA)	√	√

HVAC				
Terminal	Device	1H	1C	1H1C
TH	Console	Connect the console sensor between the TH terminals (no polarity)		
TH				
PS	Plenum sensor	Connect the plenum sensor between the PS and CS terminals (no polarity)		
CS	Common S	Common terminal for both plenum sensor and outdoor sensor		
OS	Outdoor sensor	Connect the outdoor sensor between the OS and CS terminals (no polarity)		
DE		Not used		
CC	Common C	Common terminal for the unoccupied mode input		
UN	Unoccupied mode input	Connect a dry contact between UN and R terminals (no polarity)		
H	Humidifier (24 Vac / 1 A)	Connect the humidifier between the H terminals (dry contact)		
H				
R	Power (24 Vac)	√	√	√
C		√	√	√
Y	Cooling unit (24 Vac / 1 A)		√	√
W	Heating unit (24 Vac / 1 A)	√		√
O/B		Not used		
G	Fan (24 Vac / 1 A)	√	√	√
L		Not used		
WW		Not used		

Wiring Diagram: 2H1C Heat Pump — New Installation

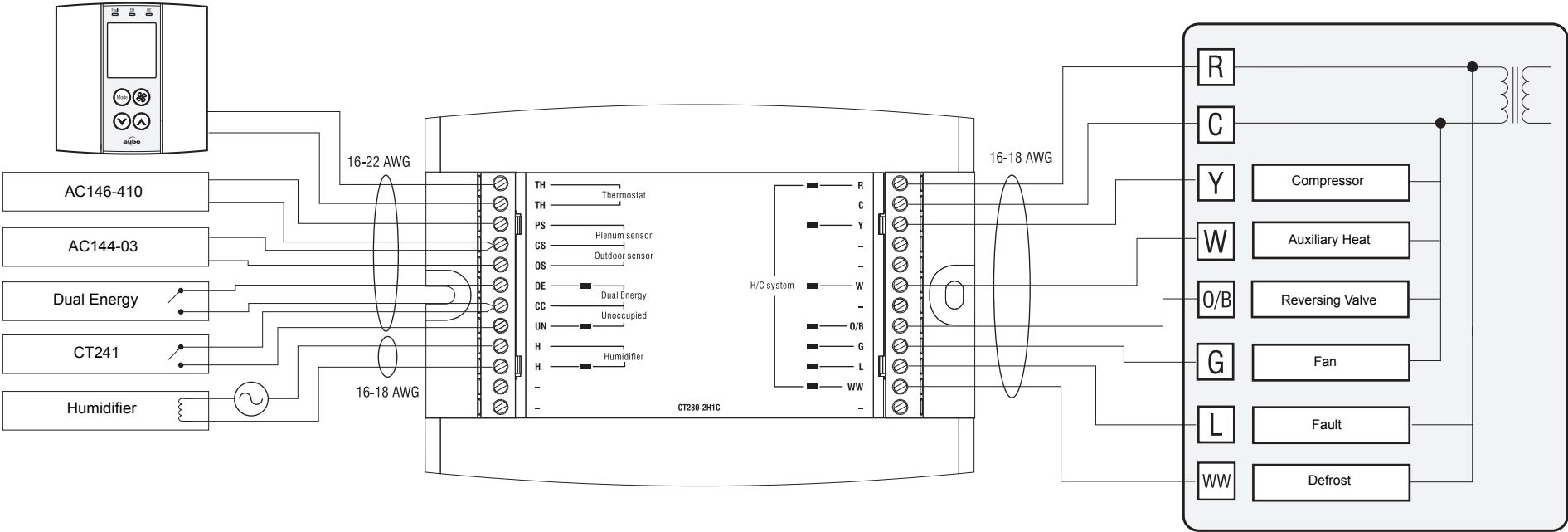

Wiring Diagram: 2H1C Heat Pump — Add-on Installation

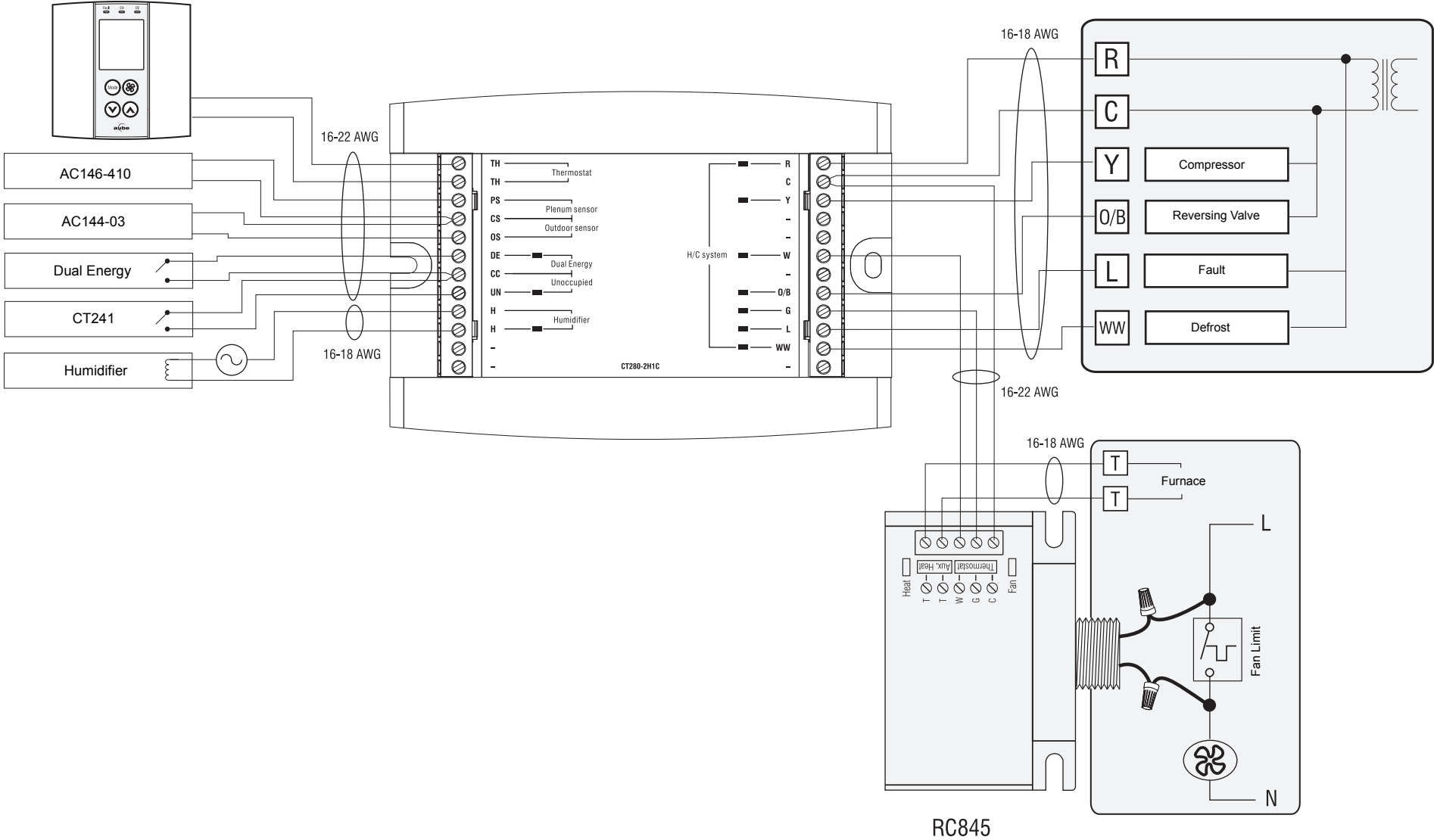

Wiring Diagram: 1H1C HVAC

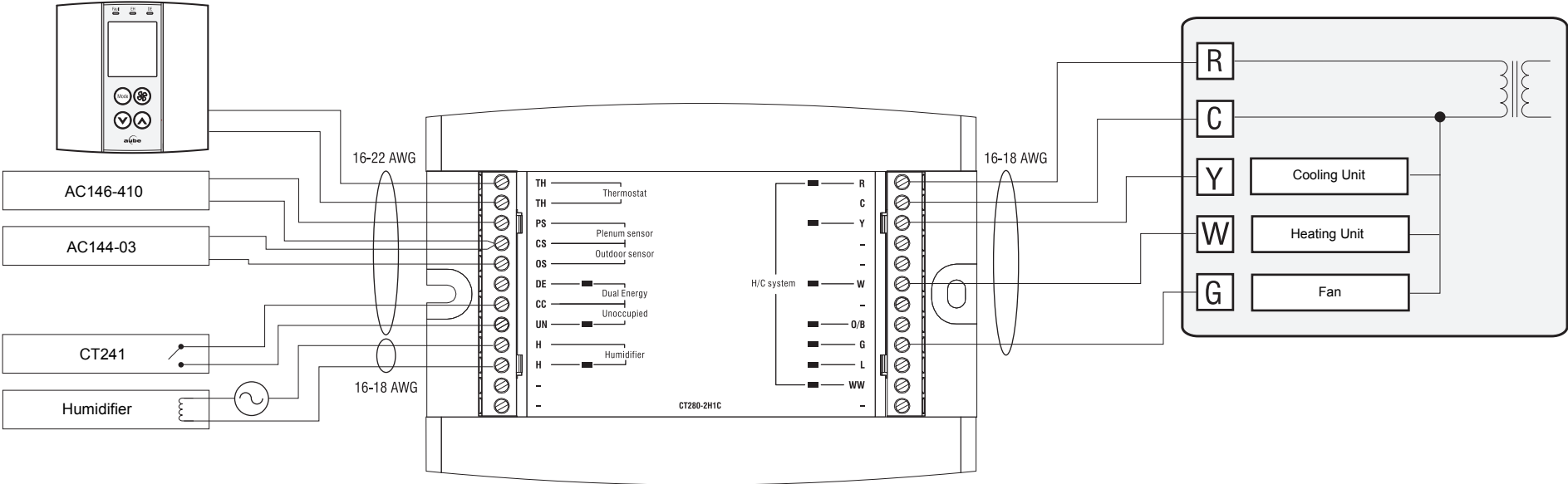

Configuration Menu

Item	HP	HVAC	Parameters	Display	Options	Default	Description
1	√	√	Temperature format	dISP	°C / °F	°C	Select the temperature display format.
2*	√		Balance point low	bP L	-30 to 10°C (-22 to 50°F)	-10°C (14°F)	Set the bP L limit (see section 4.2). NOTE: Lower bP L below its minimum (-) if you do not wish to use this function.
3*	√		Balance point high	bP H	-5 to 30°C (23 to 86°F)	5°C (41°F)	Set the bP H limit (see section 4.2). NOTE: Raise bP H above its maximum (-) if you do not wish to use this function.
4*	√		Defrost point	DEFr	-10 to 15°C (14 to 59°F)	10°C (50°F)	Set the defrost point temperature (see section 4.3). NOTE: Raise the defrost point above its maximum (-) if you do not wish to use this function.
5*	√		Installation type	INST	Ad / nr	Ad	Set according to the type of heat pump installation (see section 4.4). • Ad (add-on): Use this setting when the indoor coils are located downstream of the auxiliary heat source. This is generally the case for add-on installations. • nr (normal): Select this setting when the indoor coils are located upstream of the auxiliary heat source. This is generally the case for new installations.
6*	√		Auxiliary interstage delay	A IST	5 to 90 min.	30 min.	Set the interstage delay for the auxiliary stage (see section 4.5).
7		√	Low temperature limit	LLPNT	-10 to 20°C (14 to 68°F)	--	Set the low temperature limit of the plenum (see section 4.6). NOTE: This function is not used if you lower LLMT below its minimum (-) or if the plenum temperature sensor is not connected to the controller.
8		√	High temperature limit	HLPNT	30 to 90°C (86 to 194°F)	--	Set the high temperature limit of the plenum (see section 4.6). NOTE: This function is not used if you raise HLMT above its maximum (-) or if the plenum temperature sensor is not connected to the controller.
9	√	√	Cycles per hour	CPH	2 to 6	4	Select the number of heating/cooling cycles per hour. For optimal heating control, use the setting that matches your system as follows: 3=20 min (hot water, 90%+ high-efficiency furnace), 4=15 min (gas or oil), 5=12 min (gas or oil), 6=10 min (electric).
10	√	√	Heat type	HEAT	GA / EL	EL	This setting determines the fan operation in automatic mode when the system is in heating mode (see section 5.2). • EL (electric heating): The fan starts when heating starts and stops when heating stops. • GA (gas or oil heating): The fan starts when the temperature inside the plenum rises above the Fan Limit (see item 11) and stops when the temperature drops 12°C below the Fan Limit. Note: The fan will not start if the plenum temperature sensor is not connected to the controller.
11	√	√	Fan limit	FLPNT	38 to 90°C (100 to 194°F)	80°C (176°F)	This parameter is available only when gas heating is selected (see item 10). WARNING: FLMT can be used in parallel with an UL353-approved device but they do not replace such device. NOTE: The fan will not start if you raise FLMT above its maximum (--).
12	√	√	Smart Fan	SFAN	On / OF	OF	• On: Smart Fan is On (see section 4.7). • OF: Smart Fan is Off.
13	√	√	Temperature setback	UNOC	0 to 9°C (0 to 16°F)	0°C (0°F)	Set the amount of temperature setback when the controller is placed in Unoccupied mode (see section 5.6).
14	√	√	Outdoor temperature display	ODT	On / OF	On	Select between displaying the outdoor temperature or the indoor humidity level. • On: Displays the outdoor temperature. • OF: Displays the indoor humidity level. NOTE: To display the outdoor temperature, the outdoor sensor must be connected.
15	√	√	Humidifier operating mode	HUM	Co / HE / Fn	HE	• Co (conventional): The humidifier will operate if the humidity is too low. If the fan is not already On, it will turn On at the same time as the humidifier. • HE (heat): The humidifier can operate only when heating is activated. • Fn (fan): The humidifier can operate as long as the fan is running, whether heating is activated or not. NOTE: The humidifier is disabled when cooling is activated.
16	√	√	Automatic humidity adjustment	H AUTO	On / OF	OF	Allows you to set the humidity control to automatic mode. • On (automatic): The humidity level is automatically regulated by the controller according to the outdoor temperature to avoid condensation or ice formation on windows while providing enough humidity for your comfort (see item 17). • OF (manual): The user manually sets the humidity level (see item 17).
17**	√	√	Humidity setpoint	SP H	5 to 60%	5 %	Set the desired humidity level. This parameter is available only when the humidity control is placed in manual mode (see item 16).
			Humidity offset		-9 to 9%	0	This parameter is available only when the humidity control is placed in automatic mode (see item 16). It allows the user to apply an offset to the automatic humidity control. For example, the user can enter a negative offset if there is ice formation or condensation on the windows.

* Parameters 2 to 6 are not available when the controller is configured for 1H1C, 2H2C or 3H3C heat pump.

** Only parameter 17 is available when the controller is in user mode (SW1-2 switch).

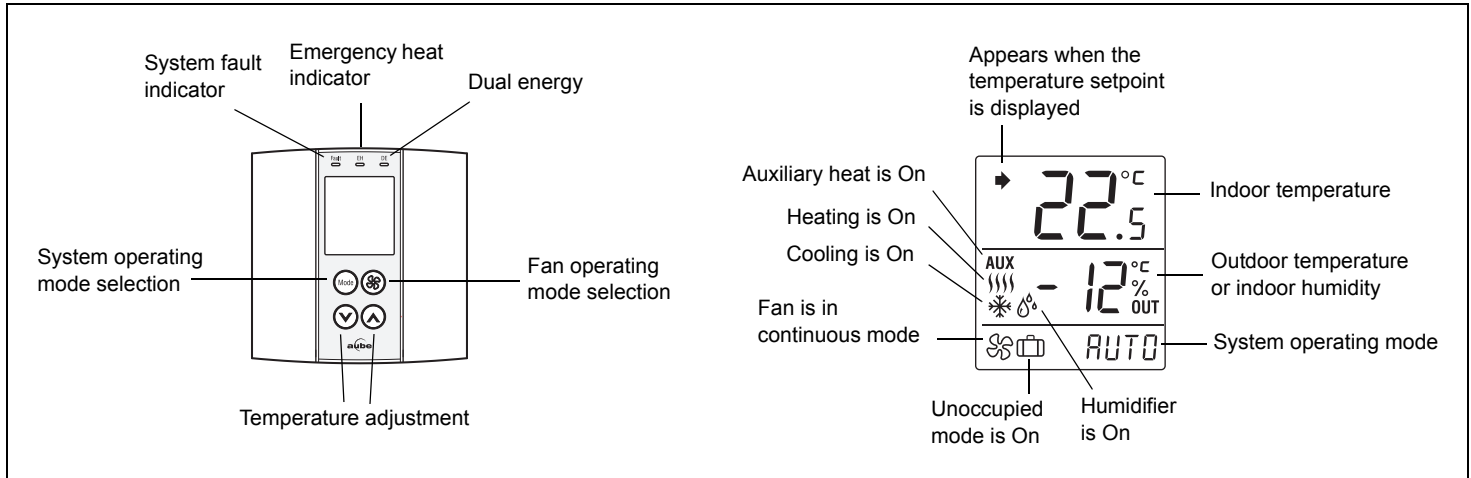

5. Operation

5.1 System Operating Mode

Press the **Mode** button to place the system in one of the following modes:

HEAT	The system is in heating mode.
COOL	The system is in cooling mode.
AUTO	The system is in automatic changeover mode. (The system switches between heating mode and cooling mode to maintain the desired temperature.)
OFF	The system is off.
EHEAT	The system is in emergency heat mode. Only auxiliary heating is used when there is a call for heat. (This mode applies only when the controller is connected to a heat pump equipped with auxiliary heating).

* Some modes might not be available depending on your system.

5.2 Fan Operating Mode

Press the **Fan** button to select the fan operating mode.

- In automatic mode, the fan runs only when heating or cooling is activated. **NOTE:** For gas-operated HVAC systems, there might be a delay before the fan starts or stops when heating is activated or deactivated.
- In continuous mode, the fan runs continuously and the symbol is displayed. **NOTE:** If Smart Fan is enabled, when the thermostat is in unoccupied mode, the fan runs only when heating or cooling is activated.

5.3 Indoor Humidity / Outdoor Temperature Display

The controller can display either the indoor humidity level or the outdoor temperature (see page 8, item 13).

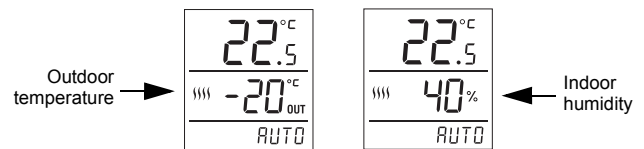

5.4 Temperature Setting

The actual (measured) indoor temperature is normally displayed. To view the setpoint temperature, press one of the buttons once. The setpoint is displayed for 5 seconds and is indicated by the symbol.

To modify the temperature setpoint, press one of the buttons until the desired temperature is displayed.

NOTE: If the controller is in automatic heat/cool changeover (see section 5.1), the setpoint is automatically reduced or raised by 1°C (1.8°F) when the controller switches to heating mode or to cooling mode respectively. For example, if the setpoint is 24°C (75°F) in heating mode, it will become 25°C (77°F) in cooling mode and will return to 24°C (75°F) when the controller switches back to heating mode.

5.5 Humidity Setting

NOTE: Skip this section if you do not have a humidifier connected to the controller.

The humidity level can be set manually or automatically (see page 8, item 16).

Manual Setting

In manual setting, the user sets the humidity level (5 to 60%).

- 1) Press the **Mode** button for 3 seconds.
- 2) Press the \odot/\ominus buttons to set the humidity level.
- 3) Press the \otimes button to exit.

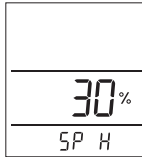

The \odot symbol is displayed when the humidifier is On.

Automatic Setting

In automatic setting, the controller sets the humidity level based on the outdoor temperature to prevent ice formation or condensation on windows. However, the user can apply an offset (-9 to 9%). For example, the user can enter a negative offset if there is too much condensation on the windows.

- 1) Press the **Mode** button for 3 seconds.
- 2) Press the \odot/\ominus buttons to set the offset value.
- 3) Press the \otimes button to exit.

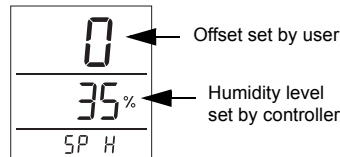

The \odot symbol is displayed when the humidifier is On.

5.6 Unoccupied Mode

You can place the controller in the unoccupied mode using a remote control device such as Aube's CT241 telephone controller. In this mode, the temperature is lowered in heating mode or raised in cooling mode (see page 8, item 13). The \square icon appears during the unoccupied mode.

NOTE: Automatic heating/cooling changeover is disabled during the unoccupied mode.

5.7 Temporary Bypass

If you change the temperature setpoint (using the \odot/\ominus buttons) in unoccupied mode, the controller temporarily bypasses the current setpoint. The new setpoint will be maintained for 2 hours, after which the controller will return to the previous setpoint. The \square icon flashes during the bypass.

6. Technical Specifications

CT280-2H1C CONTROL MODULE

Power supply: 24 VAC

Current consumption: 150 mA

Maximum load per output: 1 A @ 24 VAC

Short cycle protection

- **Minimum off-time:** 4 minutes
- **Minimum on-time:** 2 minutes

Control cycles: 2 to 6 per hour

Operating temperature: 0°C to 50°C (32°F to 122°F)

Storage temperature: -20°C to 50°C (-4°F to 122°F)

Humidity conditions: 0 to 95%, non-condensing

Dimensions: 95 x 137 x 30 (3.8 x 5.4 x 1.2 in.)

TH146 USER CONSOLE

Temperature setpoint range: 5°C to 30°C (40°F to 86°F)

Humidity setpoint range: 5 to 60%

Indoor temperature display range: 0°C to 70°C (32°F to 158°F)

Outdoor temp. display range: -50°C to 70°C (-58°F to 158°F)

Temperature display resolution: 0.5°C (1°F)

Program protection: non-volatile memory

Operating temperature: 0°C to 50°C (32°F to 122°F)

Storage temperature: -20°C to 50°C (-4°F to 122°F)

Humidity conditions: 0 to 95%, non-condensing

Dimensions: 79 x 79 x 24 mm (3.1 x 3.1 x 1 in.)

7. Warranty

Honeywell warrants this product, excluding battery, to be free from defects in the workmanship or materials, under normal use and service, for a period of three (3) years from the date of purchase by the consumer. If at any time during the warranty period the product is determined to be defective or malfunctions, Honeywell shall repair or replace it (at Honeywell's option).

If the product is defective,

- (i) return it, with a bill of sale or other dated proof of purchase, to the place from which you purchased it, or
- (ii) contact Honeywell. Honeywell will make the determination whether the product should be returned, or whether a replacement product can be sent to you.

This warranty does not cover removal or reinstallation costs. This warranty shall not apply if it is shown by Honeywell that the defect or malfunction was caused by damage which occurred while the product was in the possession of a consumer.

Honeywell's sole responsibility shall be to repair or replace the product within the terms stated above. HONEYWELL SHALL NOT BE LIABLE FOR ANY LOSS OR DAMAGE OF ANY KIND, INCLUDING ANY INCIDENTAL OR CONSEQUENTIAL DAMAGES RESULTING, DIRECTLY OR INDIRECTLY, FROM ANY BREACH OF ANY WARRANTY, EXPRESS OR IMPLIED, OR ANY OTHER FAILURE OF THIS PRODUCT. Some provinces and states do not allow the exclusion or limitation of incidental or consequential damages, so this limitation may not apply to you.

THIS WARRANTY IS THE ONLY EXPRESS WARRANTY HONEYWELL MAKES ON THIS PRODUCT. THE DURATION OF ANY IMPLIED WARRANTIES, INCLUDING THE WARRANTIES OF MERCHANTABILITY AND FITNESS FOR A PARTICULAR PURPOSE, IS HEREBY LIMITED TO THE THREE-YEAR DURATION OF THIS WARRANTY. Some provinces and states do not allow limitations on how long an implied warranty lasts, so the above limitation may not apply to you.

This warranty gives you specific legal rights, and you may have other rights which vary by province, state or region.

8. Technical Assistance

Honeywell Limited

705 Montrichard Avenue
Saint-Jean-sur-Richelieu, Quebec
J2X 5K8
Canada

1-800-831-2823

aube.service@honeywell.com
www.aubetech.com

