



- **PIN Access**
- **Mechanical Pushbutton Lock**
- **Single Access Code**
- **Deadbolt/Spring Latch**
- **Thumbturn**

Features

Access Control:	Mechanical pushbutton lock—eliminates problems and costs associated with issuing, controlling, and collecting keys and cards. Provides fully mechanical access control, while allowing free egress at all times by interior thumbturn. Deadbolt models must be manually relocked. Deadlocking spring latch models automatically relock each time the door closes.
No Battery:	Fully mechanical lock eliminates the material and labor expense of battery replacements
Locking Device Options:	Deadbolt— 1" throw, manual relock Deadlocking Latch— $\frac{5}{8}$ " throw, with automatic relock
Number of Codes:	Single access code—one easy to manage code for all users
Programming:	Lock is easily programmed via keypad without removing lock from the door
Handing:	Field reversible latch; invert the lock for right hand doors; roman numerals are easily read in either orientation
Optional Key Override:	Can be used to override the lock combination and gain access using a key. Allows facilities to initiate or maintain a master-keyed security system (keyed alike or keyed differently). Override models can be ordered with or without a cylinder.
Options:	<ul style="list-style-type: none"> • Add panic bar release kit (select models) • Master keying available (select models) • Latch holdback (select models) • DOD compliance (select model) • Substitute a 2 1/2" (64 mm) lever in place of the standard inside thumbturn (select models)
Operation Modes:	Single credential—access Latch holdback—keeps latch retracted to allow access with combination (select models)
Economical:	A cost effective access control solution

Mechanical Features

Construction:	All metal cast front housing, force-proof, clutch-protected thumbturn, metal exterior trim plate
Numeric Keypad:	Vandal resistant, solid metal pushbuttons
Handing:	Field reversible latch; invert the lock for right hand doors; roman numerals are easily read in either orientation
Finishes:	04 (633) Satin Brass and 26D (626) Satin Chrome Model 929: 26D (626) Satin Chrome only
Latch:	1" (25 mm) deadbolt; $\frac{5}{8}$ " deadlocking spring latch
Weight:	4 lbs. (1.8 kg)
Strike:	Includes strike plate for outswing doors, cast box strike for inswing doors; metal door frames require the optional surface mortise box strike or use of an adapter kit

Installation

Backset:	2 9/16" (65 mm) for outswing doors, 2 1/2" (64 mm) for inswing doors
Door Thickness:	1 3/8" (35 mm) to 1 1/2" (38 mm) 1 3/4" (44 mm) to 2 1/8" (54 mm) Model 929: Lockset for DOD standards, 1 3/4" (44 mm) to 2 1/8" (54 mm) only
Items Supplied Include:	Installation manual, full-scale template, strike for inswing and outswing doors (appropriate to latch type), and required installation hardware

Certification and Testing

Durability:	Highly weather resistant
--------------------	--------------------------

Warranty

Warranty:	1-year warranty
------------------	-----------------

Auxiliary Lock

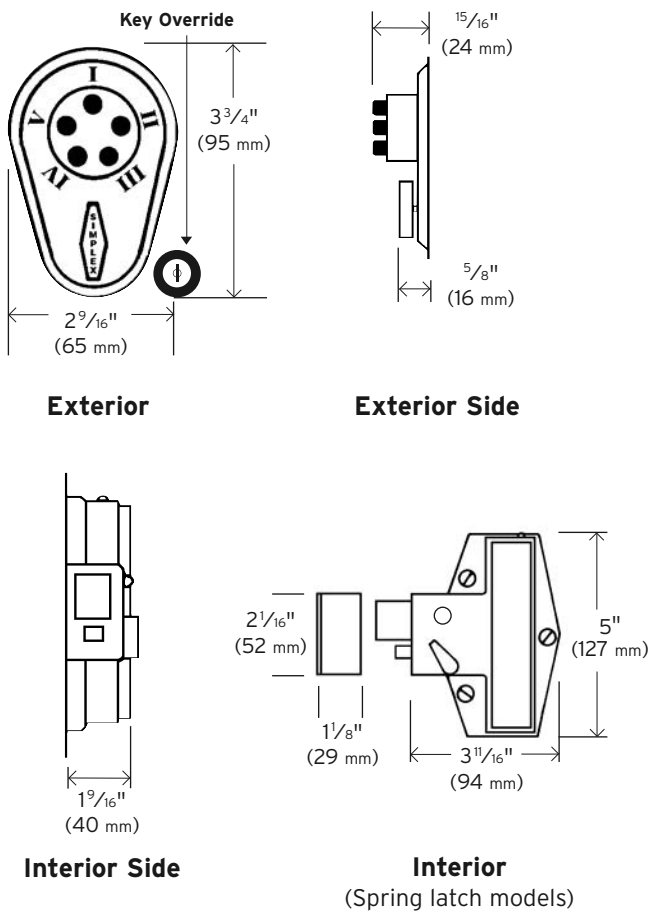

Models 902, 904, 906, 910

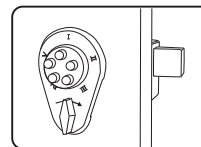

- Combination Entry
- Deadbolt
- 1" (25 mm) Throw, Flat Face Plate

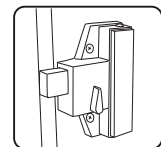

- Auxiliary Lock
- Manual Relock
- Key Override (Select Models)

Models 917, 919, 935, 938

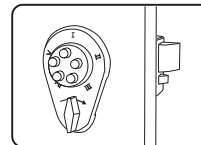

- Combination Entry
- Deadlocking Latch
- 5/8" (16 mm) Throw, Flat Face Plate

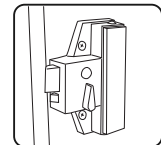

- Primary or Auxiliary Lock
- Automatic Relock
- Key Override (Select Models)

Models 929

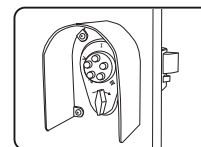

- Combination Entry
- Security Lock
- 5/8" (16 mm) Throw

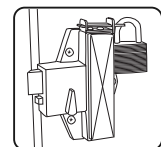

- Primary or Auxiliary Lock
- Automatic Relock
- DOD Compliant

Example

9	0	2	0	0	0	0	-	2	6	D	-	4	1
---	---	---	---	---	---	---	---	---	---	---	---	---	---

9		
---	--	--

Model

--	--	--	--

Options

--	--	--

Finish

4	1
---	---

Packaging

Build the model number with the desired options**Base Model Description**

902000026D41 Auxiliary Lock with Thumbturn,
1" (25 mm) Deadbolt, Fits 1 3/8" - 1 1/2"
(35mm - 38mm) thick

Choose one option from this category**Model Options Description**

02	1" (25 mm) Deadbolt latch, 1 3/8"-1 1/2" (35 mm-38 mm) thick
04	1" (25 mm) Deadbolt latch, 1 3/4"-2 1/8" (44 mm-54 mm) thick
06	1" (25 mm) Deadbolt latch, 1 3/8"-1 1/2" (35 mm-38 mm) thick key override
10	1" (25 mm) Deadbolt latch, 1 3/4"-2 1/8" (44 mm-54 mm) thick key override
17	5/8" (16 mm) Deadlocking spring latch, flat front, 1 3/8"-1 1/2" (35 mm-38 mm) thick Latch holdback
19	5/8" (16 mm) Deadlocking spring latch, flat front, 1 3/4"-2 1/8" (44 mm-54 mm) thick Latch holdback
20	5/8" (16 mm) Deadlocking spring latch, flat front, 1 3/8"-1 1/2" (35 mm-38 mm) thick No latch holdback
22	5/8" (16 mm) Deadlocking spring latch, flat front, 1 3/4"-2 1/8" (44 mm-54 mm) thick No latch holdback
29**	5/8" (16 mm) Deadlocking spring latch, flat front, 1 3/4"-2 1/8" (44 mm-54 mm) thick
35	5/8" (16 mm) Deadlocking spring latch, flat front, 1 3/8"-1 1/2" (35 mm-38 mm) thick Latch holdback, key override
38	5/8" (16 mm) Deadlocking spring latch, flat front, 1 3/4"-2 1/8" (44 mm-54 mm) thick Latch holdback, key override

Notes

+ 04 Finish not available on Model 929

** DOD Compliant

Choose up to 4 options—Insert 0 if less than 4 options are required.

Options Description

1	Substitutes a surface mounted strike box for <u>metal door frames</u> in place of the standard strike box (part number 74464). (See 900 Series Accessories— Adapter list)
2	Deletes the key cylinder from key override models. Recessed escutcheon recommended for standard rim cylinder installation. Your rim cylinder tailpiece must be reduced in width to accommodate the tail receptacle. Specify the position of your cylinder tailpiece (vertical or horizontal) to mate with your standard size rim cylinder (not supplied).
3	Substitutes a 2 1/2" (64 mm) lever in place of the standard inside thumbturn (part number 74437)
4	Master key (key override models).
5	Adds the panic bar release kit to a spring latch model (part number 74438)
6	Delete latch holdback (935 and 938 models).
7	Deletes the key cylinder from key override models and changes gear plate to a 100 Series. Recessed escutcheon recommended for standard rim cylinder installation. Your rim cylinder tailpiece must be reduced in width to accommodate the tail receptacle. Specify the position of your cylinder tailpiece (vertical or horizontal) to mate with your standard size rim cylinder (not supplied).
8	Changes gear plate to accept a horizontal tailpiece.

Finish Options Description

26D	Satin Chrome (Powder Paint)
04*	Satin Brass (Powder Paint)

Simplex® 2015 Series

Model	Description
54266	Blank Keys
54266-1-11	Master Keys for key override models. (Old #54266-1) (Specify Keycut)
54266-2-11	Service Keys for override models. (Old #54266-2) (Specify Keycut)

Simplex® 6200 Series

Model	Description
55072-03-01	Filler Plate—Bright Brass
55072-26D-01	Filler Plate—Satin Chrome
55072-19-01	Filler Plate—Black

Simplex® 900 Series

Model	Description
800-04-41	Adapter kit for doors with metal frames. Includes riser plates and surface mounted strike. Finish 04 Satin Brass; packaged 1 per box. (Old #74464/74468)
800-26D-41	Adapter kit for doors with metal frames. Includes riser plates and surface mounted strike. Finish 26D Satin Chrome; packaged 1 per box. (Old #74464/74468)
805-26D-41	Face plate shield. Not for use with key override models. Inhibits unauthorized observation of the combination. Finish 26D Satin Chrome; packaged 1 per box. (Old #24081-000-01)
54266	Blank Keys
54266-1-11	Master Keys for key override models. (Old #54266-1) (Specify Keycut)
54266-2-11	Service Keys for key override models (Old # 54266-2) (Specify Keycut)

Simplex® 1000, L1000 & 5000 Cores & Wrap Plates

Model	Description
204231-03-41	Wrap Plate, 10 ½" (267 mm), Bright Brass (605)
204231-05-41	Wrap Plate, 10 ½" (267 mm), Antique Brass (609)
204231-26D-41	Wrap Plate, 10 ½" (267 mm), Satin Chrome (626)
204232-03-41	Wrap Plate, 15" (381 mm), Bright Brass (605)

204232-05-41	Wrap Plate, 15" (381 mm), Antique Brass (609)
204232-26D-41	Wrap Plate, 15" (381 mm), Satin Chrome (626)
20484-03-01	Best Equivalent SFIC Bright Brass (605)
201484-05-01	Best Equivalent SFIC Satin Brass (609)
201484-26D-01	Best Equivalent SFIC Satin Chrome (626)
201600-083-01	Anti-Spy Shield (1000/L1000 Models Only)
204022-000-01	Latch Extension Assembly converts to 3¾" (10 cm) Backset
204023-000-01	Latch Extension Assembly converts to 5" (13 cm) Backset
54644-000-41	Weather Cover (smoke colored)
64754-000-01	Lubriplate Aero Grease Tubes (1.75 oz tubes) 150°F to -70°F (66°C to -57°C)
64684-26D-01	Installation Jig (1000/L1000/5000/E5000)

Simplex® Mounts*

Model	Description
204246-000-41	LD Series—450 & 470 Dual Mount
04083-000-41	8100 Series
204086-000-41	EE1000 Series
204087-000-41	LP1000 Series
203053-000-41	900 Series— 904 & 919 Dual Mount
204189-000-41	7100 Series— 7108 & 7104 Dual Mount
204092-000-41	7100 Series—(7106 Series Only)
204094-000-41	6200 Series
204096-000-41	2015 Series
203044-000-41	1000, L1000, 5000 Series
74378-CH	3000 Series Narrow Stile
SP5000 ACLMT	Simplex 5000 Acrylic Mount

* Mounts do not include locks

Hardwood product demonstration mount, packaged 1 per box.