

EXPCMR-ALG-OZ-IC-1080P-1227 HD-TVI Motorized Auto-focus Infrared Bullet Camera Quick Installation and User Guide

The EXPCMR-ALG-OZ-IC-1080P camera delivers 1080p high-definition video resolution over RG59 coax or any standard analog CCTV cabling. It features a motorized 5 ~ 50 mm vari-focal lens with auto-focus. These HD video camera is ideal for long range security applications that require high detail, such as facial recognition or license plate identification.

Features

- 2 MP CMOS image sensor w 1080p video output
- HD-TVI technology produces 1080p HD video for sharp, detailed images
- 5 ~ 50 mm motorized vari-focal lens with viewing angle of 59.8° ~ 6° and auto-focus
- True day/night (ICR) captures sharp, clear images in low light and at night
- OSD (On-Screen Display) controls for customizing the camera settings for the installation venue
- -40 °F ~ 140 °F temperature operating range
- IP66 weather-rated housing



EXPCMR-ALG-OZ-IC-1080P-1227 Camera

This unit must be installed by a licensed electrician in accordance to NFPA 70 / NEC Code Book Article 500.

Mounting

The mounting bracket allows 90° vertical adjustment and 360° of swivel for precision aiming. Mount the unit to a flat surface using the predrilled 3/8" mounting holes. Position the camera loosely until connected to a monitor. Once connected, view the monitor and adjust the position accordingly before securing it in place.



2 x 3/4" NPT hubs are available for running connections to and from the unit via conduit.



Wiring Instructions

The EXPCMR-ALG-OZ-IC-1080P-1227 can utilize the included BNC to copper wire pair converters. By default the convertor is installed on the camera. When utilizing the convertors be sure you are using a dedicated pair of wires that do not go through transfer or are wired into line voltage of any kind.

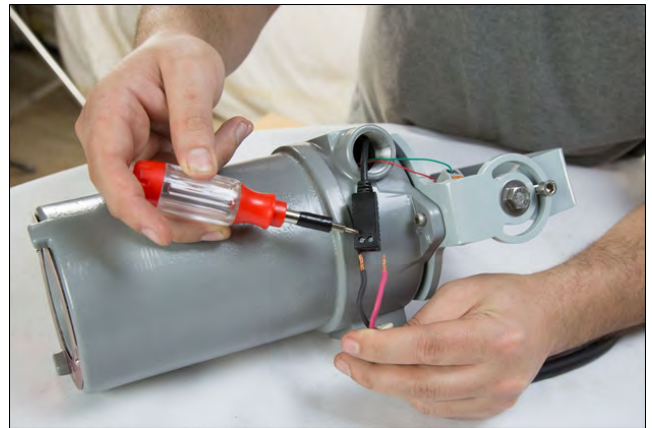

Connect a copper wire to the plus and negative receptacles on the convertor making note of which color you use.

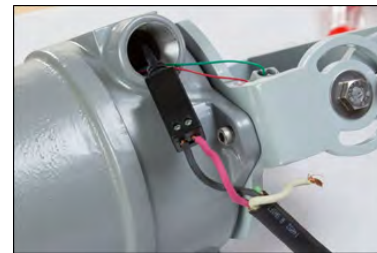

Connect the second adaptor that will hook into the DVR. Make sure to use the same colors for positive and negative on both ends.

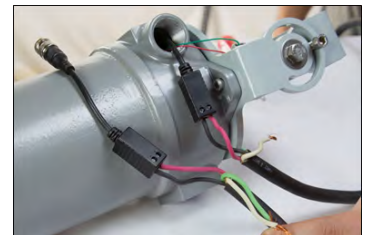

Plug into DVR

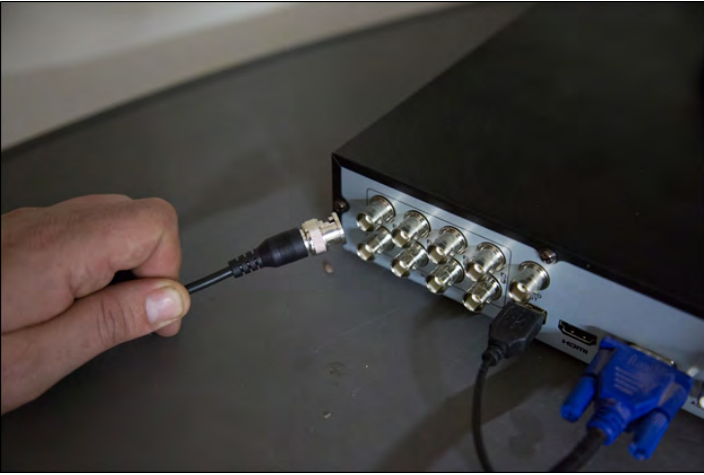

For power hookups connect AC HOT to the BROWN wire and AC NEUTRAL to the BLUE wire using the provided terminal strips. Connect GROUND (GREEN) to the terminal screw inside the housing.

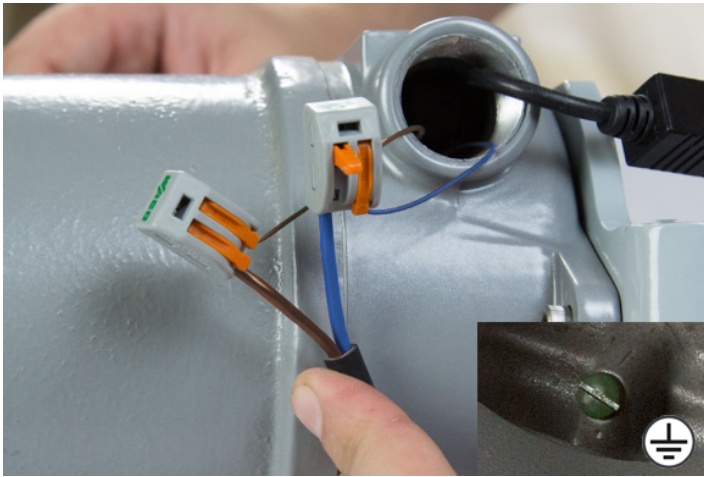

Camera adjustments

1. Apply power to the camera.
2. Verify that video from the camera can be seen on a monitor. **NOTE:** Video from the CVBS drop cable or the video test cable is NTSC video and can be displayed on most NTSC compatible monitors. Video from the HD-TVI drop cable must be connected to an HD-TVI compatible video recorder (DVR) system.
3. While observing video from the camera, loosen the mounting bracket pan, elevation and horizontal line adjustment lock screws, point the camera at your surveillance target, and then tighten adjustment lock screws or nuts to hold the camera in position.

USING THE OSD

Use the OSD to adjust the internal settings of the camera to customize it for the installation venue.

1. Unscrew the lens cover of the camera to access OSD joystick and WDR switch. See photos above.

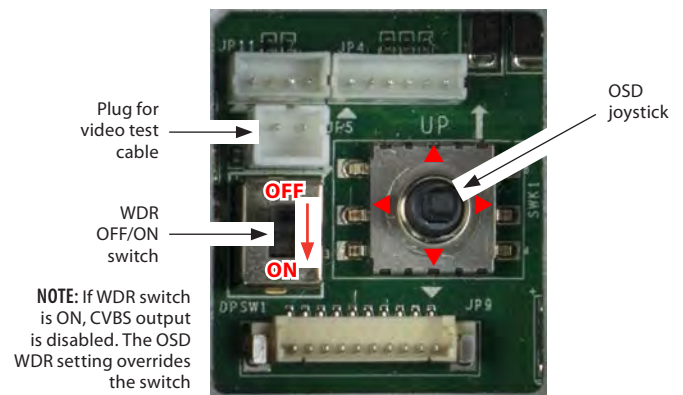

The OSD joystick is used to open the OSD menu and navigate through the menus. To open the camera menus and select a menu option, press the joystick down (in toward the camera body). To navigate the menus, rock the joystick up (▲), see photo above) or down (▼) to move through the parameter list menu vertically, rock the joystick left (◀) or right (▶) to change the parameter value that appears for the parameter. Press the joystick down (in toward the camera body) to select the parameter value shown. Changes made to the OSD setup must be saved to be restored after power off and power on.

Most menus have a RETURN that returns you to the previous menu. EXIT closes the OSD.

2. Open the OSD menus by pressing the joystick in toward the base assembly. The OSD menu tree is shown below. Use the OSD to configure the camera as needed.

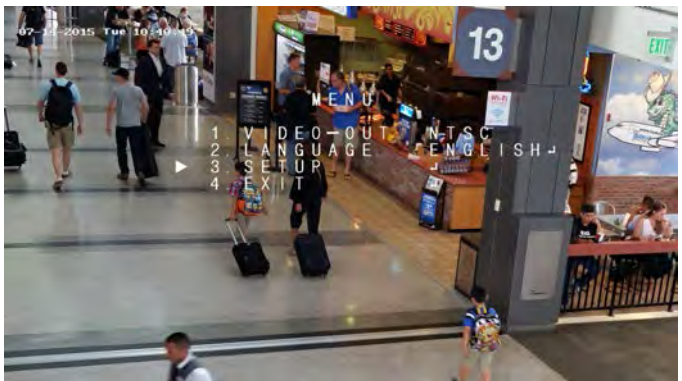

OSD top level menu



- 120 VAC or 240 VAC power source. See *Specifications* for wattage requirement.

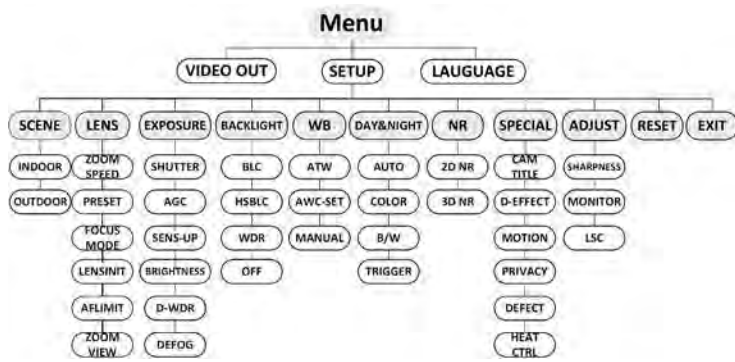

OSD menu tree

MENU: Rock the joystick down or up to select either VIDEO-OUT, SETUP or LANGUAGE.

VIDEO-OUT: Rock the joystick right or left to select either NTSC or PAL.

LANGUAGE: Rock the joystick right or left to select either English or Chinese

SETUP menu:

- **SCENE:** Rock the joystick right or left to select either INDOOR or OUTDOOR for the best image.
- **LENS:** The camera is equipped with 5-50 mm motorized vari-focal lens. Click Zoom + and Zoom - on the DVR PTZ control to zoom in / out. The camera automatically focuses after zoom.
 - **ZOOM SPEED:** Move the cursor left/right to adjust the zoom speed.
 - **PRESET:** You can set, delete, and call the preset. You can create up to 64 presets.
 - SELECT:** Select a zoom preset number (1 .. 64).
 - SET:** Press the joystick in open the ZOOM setup tool, and then rock the joystick up (▲) or down (▼) to increase or decrease the zoom. Press the joystick in to save the setting.

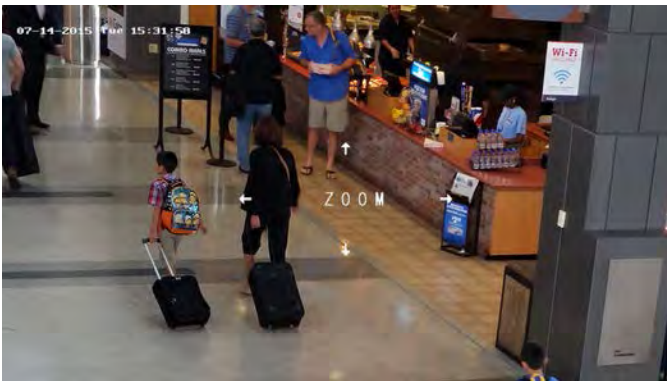

- **DELETE:** Clear the zoom preset.
- **USE:** Apply the preset.
- **FOCUS MODE:** Select either MANUAL, AUTO or TRIGGER. In AUTO mode, the camera focuses automatically, and in MANUAL mode, click Zoom+ and Zoom- on the DVR PTZ menu to focus.
- **LENSINIT:** You can reset the lens.
- **AFLIMIT:** 20 m, 10 m, 6 m, 3 m, 1.5 m, 1 m, 30 cm, and 10 cm are selectable as the Min. focus distance limit.
- **ZOOM VIEW:** Enable the zoom view.
- **EXPOSURE**
 - **EXPOSURE:** Rock the joystick right or left to select either IRIS-PRIority or MANUAL. In IRIS-PRI, SHUTTER, AGC and SENS-UP are not configurable.
 - **SHUTTER:** (EXPOSURE – MANUAL mode only) Rock the joystick right or left to select either AUTO, 1/25, 1/75, 1/100, 1/120... 1/3.5k, 1/6k, 1/10k, 1/20k or 1/30.
 - **AGC:** Rock the joystick right or left to select an AGC value from 0 to 15.
 - **SENS-UP:** Rock the joystick right or left to set the SENS-UP to OFF or AUTO.
 - **BRIGHTNESS:** Rock the joystick right or left to select the brightness value (1 .. 14).
 - **D-WDR:** Rock the joystick right or left to set the D-WDR to ON to improve the image quality or OFF to disable the function.
 - **DEFOG:** Rock the joystick right or left to set the defog function to OFF or ON. When set to ON, press the joystick in to open the submenu. You can set the position, size, and the defog gradation.

- **BACKLIGHT** compensation. Rock the joystick right or left to select either OFF, WDR, HSBLIC, or BLC.
 - **WDR** (Wide Dynamic Range): Push the joystick in to open the WDR submenu. In the submenu, rock the joystick left or right to set the WDR ON or OFF.
 - **HSBLIC:** Push the joystick in to open the HSBLIC submenu.
 - **AREA:** Rock the joystick right or left to select the area (AREA1 .. AREA4) you want to configure.
 - **DISPLAY:** Rock the joystick right or left to select either OFF or ON. If ON, press the joystick in to open set the size and position of the area by rocking the joystick up, down, left or right.
 - **LEVEL:** Rock the joystick right or left to set the HSBLIC level (0 .. 100).
 - **MODE:** Rock the joystick right or left to select either ALL DAY or NIGHT.
 - **BLACKMASK:** Rock the joystick right or left to set the status to ON or OFF.
 - **Default:** Restore the HSBLIC settings to the default.
- **BLC:** Push the joystick in to open the BLC submenu.
 - **GAIN:** Set the gain of BLC as High, Middle, or Low.
 - **AREA:** Press the up/down/left/right button to define the BLC position and size. Select RET or AGAIN to go back the BLC menu or redefine the BLC area.
 - **Default:** Restore the BLC settings to the default.
- **WHITE-BAL:** Rock the joystick right or left to select either MANUAL, ATW (auto-tracking white balance), or AWCSET.
 - **MANUAL:** In this mode, you can set the BLUE level and RED level (1 .. 20).
- **DAY&NIGHT: NOTE:** For best performance, do not change the default DAY&NIGHT settings.
- **NR** (Noise Reduction).
 - **2DNR:** Rock the joystick right or left to select either OFF or ON.
 - **3DNR:** Rock the joystick right or left to select either OFF or ON. If set to ON, press the joystick in to open the submenu:
 - **SMART NR:** Rock the joystick right or left to select either OFF or ON. If ON, press the joystick in to select the sensitivity.
 - **LEVEL:** Rock the joystick right or left to set the level of noise reduction (0 .. 32).
 - **START AGC:** Rock the joystick right or left to set the threshold level to enable AGC (0 .. 32).
 - **END AGC:** Rock the joystick right or left to set the threshold level to disable AGC (0 .. 100)
- **SPECIAL**
 - **CAMERA TITLE:** Rock the joystick right or left to select either OFF or ON. If ON, press the joystick in to compose a camera title. Navigate through the virtual keyboard by rocking the joystick left, right, up or down. Select a letter by pressing the joystick in. Select RET to exit.
 - **D-EFFECT:** (digital effect). This group contains the following features:
 - **FREEZE:** Rock the joystick right or left to set the FREEZE function either OFF or ON.
 - **MIRROR:** Rock the joystick right or left to set the mirror (image flip) effect to either OFF, MIRROR, V-FLIP (vertical flip), and ROTATE.
 - **DZOOM:** Define the zoom area by configuring the position from PAN & TILT.
 - **SMARTDZOOM:** A D-ZOOM area (AREA1 or AREA2) can be ON (enabled), and the position, sensitivity and time are configurable. When motion is sensed in the D-ZOOM area, the area is expanded to full screen at the D-ZOOM factor for the time (seconds) for which it is configured.
 - **NEG. IMAGE** (negative image): Rock the joystick right or left to select either OFF or ON.
 - **MOTION:** Rock the joystick right or left to select either OFF or ON. If ON, press the joystick in to open MOTION submenu.
 - **SELECT:** SELECT a motion detection area (AREA1 .. AREA4), then set the
 - **DISPLAY:** Rock the joystick right or left to select either OFF or ON. If ON, press the joystick in to open the DISPLAY submenu. In this submenu, set the size and position of the area to sense for motion.
 - **SENSITIVITY** Rock the joystick right or left to set the sensitivity level (0 .. 60).
 - **MOTION VIEW:** Rock the joystick right or left to select either OFF or ON.
 - **DEFAULT:** Push the joystick in to return the settings to the factory default values for this menu.
 - **PRIVACY:** Rock the joystick right or left to select either OFF or ON. If ON, press the joystick in to select a PRIVACY shape.
 - **SELECT:** Rock the joystick right or left to select the privacy shape (AREA 1 .. AREA8).
 - **DISPLAY:** Select either COLOR, MOSAIC, INVERT, or OFF.
 - **COLOR:** Rock the joystick left or right to select a number (represents a color). Select a number (representing a color) for the area selected. Then, press the joystick in to position and set the size of the privacy zone.
 - **TRANS:** Rock the joystick left or right to select a transparency level.
 - **DEFAULT:** Push the joystick in to return your settings to the factory default values for this menu.
 - **DEFECT:** Use this feature to compensate for camera imager defects. LIVE DPC, STATIC DPC and Black DPC are configurable.

• **ADJUST**

- **SHARPNESS:** Rock the joystick right or left to set the image sharpness level (0.. 15)
- **MONITOR:** Rock the joystick right or left to select LCD or CRT.
- **LSC (Lens Shading Compensation):** This feature compensates the brightness of the image to reduce the shading effect in image. Rock the joystick right or left to select the LSC feature to either OFF or ON.

• **RESET:** Select to reset all camera settings to factory default configuration.

• **EXIT:** Close the OSD menu system.

CONTROLLING THE OSD WITH A HVR

Some Alibi DVRs and HVRs recorders feature using a PTZ controls menu that can be used to configure the camera through the OSD. You can also control camera zoom directly through the PTZ menu. These actions can occur at the recorder console, or remotely through a browser connected to the recorder. Refer to your Alibi DVR or HVR user manual for complete instructions on how to use this feature.

To configure the OSD through the PTZ menu at the DVR or HVR console:

1. At the recorder console, open the Live View window for the ALI-BC5050AF camera.
2. Left click inside the live view window, and then click the **PTZ Control** icon in **Quick Setting** toolbar.



3. Click **Iris +** on the PTZ menu to open the OSD menu, use the ▲, ▼, ◀ and ▶ buttons to navigate through the OSD, and use **Iris +** again to open a submenu and save a parameter setting.

Controlling Zoom with the PTZ menu

To control camera zoom through the DVR or HVR:

1. Open the **PTZ Control** panel by clicking inside the live view window to open the **Quick Setting** toolbar, and then clicking the **PTZ Control** icon.



2. Click the **Zoom+** and **Zoom-** buttons to zoom in and out.

Controlling the OSD through a browser

You can open the camera OSD through a browser by logging into the Alibi recorder that manages the camera, opening the camera Live View window, and then issuing a **Preset96** to the camera. Use the PTZ control buttons, including the **Iris+** button, as described above to change the OSD.

CLEANING

Clean the camera dome with an approved glass cleaning solution and a lint free cloth.

- Dust can be removed from the unit by wiping it with a soft damp cloth. To remove stains, gently rub the surface with a soft cloth moistened with a mild detergent solution, then rinse and dry it with a soft cloth.

TROUBLESHOOTING

Problem	Possible Cause
Nothing appears on the screen	- Check the power connection. - Check the video signal cable connection to the monitor.
The video image is dim or not clear.	- If the camera lens is dirty, clean it with a soft, clean cloth. - Adjust the monitor controls, if necessary. - If the camera is facing a very strong light, change the camera position. - Adjust the lens focus.
The screen is dark.	- Adjust the contrast control of the monitor. - If you have an intermediate device, set the impedance (75 Ω /Hi-Z) properly, and check the cable connections.
The image on the monitor flickers	- Make sure that the camera isn't facing direct sunlight or fluorescent light. - If necessary, change the camera position.

Specifications

Camera	
Image Sensor:	2 Megapixel Progressive Scan CMOS
Signal System:	NTSC
Effective Pixels:	1956(H) × 1266(V)
Min. Illumination:	0.01 lux @ (F1.2, AGC on), 0 lux with IR
Shutter speed:	1/30 sec to 1/50,000 sec
Lens:	5 - 50 mm motorized VF lens Angle of view: 59.8° - 6.2°
Day & Night	ICR
Angle Adjustment	Pan: 0°~360°; Tilt: 0°~ 90°; Rotate: 0°~360°
Synchronization	Internal synchronization
Video Frame Rate	1080p @ 30 fps
HD Video Output:	1 HD-TVI output
Video Output: (CVBS)	1 Vp-p composite output (75 Ω BNC)
S/N Ratio	> 62 dB
Menu	
Camera ID	ON / OFF (15 characters, position programmable)
AGC	Support
D / N Mode	Color / BW / EXT
White balance	ATW / AWC-SET / Manual
Privacy Mask	On / Off, maximum 8 zones
Motion Detection	On / Off, maximum 4 zones
BLC	Support
Anti-flicker	ON / OFF
Language	English, Chinese
Function,	Eclipse, Digital noise reduction, Digital zoom (62x), Slow shutter, Mirror, Defog, Defective pixel correction, SMART D-ZOOM
Scene	Indoor, Outdoor, Indoor1, LOW-LIGHT
General	
Operating Conditions:	-40 °F ~ 140 °F (-40 °C ~ 60 °C)
Humidity:	90% or less (non-condensing)
Power Supply:	240 Vac / 120 Vac
Power Consumption:	Max. 11 W (heater off) Max. 20 W (heater on)
Weather Proof:	IP67
Communication	HD output: ALIBI-C protocol CVBS output: Pelco-C (requires UTC controller)
Dimension:	12.34" × 3.97" × 4.22" (313.5 × 100.8 × 107.3 mm)
Weight:	3.7 lbs (1678 g)