



User Manual

Outdoor HD IP Camera



WARNING:

- PEOPLE WITH PACEMAKERS SHOULD CONSULT THEIR PHYSICIAN(S) BEFORE USE. ELECTROMAGNETIC FIELDS IN CLOSE PROXIMITY TO HEART PACEMAKER COULD CAUSE PACEMAKER INTERFERENCE OR PACEMAKER FAILURE.
- KEEP FINGERS AWAY FROM MAGNET WHEN MOUNTING AS INJURY COULD OCCUR.

MOUNTING

Mount to a magnetic surface capable of supporting the load of the camera. Once the camera is setup, it can be placed anywhere within wifi range or standalone to record on the 64GB internal memory card.

When removing, pull the unit off magnetic surface.

To charge the internal battery, plug it in to voltage within 120-240V AC.

This weatherproof junction box is constructed from a plastic molding compound that will not rust or corrode along with a foam gasket lid sealed with stainless steel screws.

For inside access, there are four screws holding the front cover. Remove these screws and set the cover aside.

If connected, disconnect charger before opening.

Table of Contents

Security Warning.....	1
1 Overview.....	1
1.1 Key Features.....	1
1.2 PoE (Power over Ethernet).....	2
1.3 Read before Use.....	2
1.4 Packing Contents.....	2
1.5 Physical Description.....	3
1.6 SD Card Management.....	6
1.7 Wall Installation.....	7
1.8 The Different Features between the Models Involved.....	9
2 Access the IP Camera.....	10
2.1 Hardware Connection & Software Installation.....	10
2.2 Access the Camera In LAN.....	10
2.3 Access the Camera in WAN.....	12
2.4 Using the VLC Player.....	15
2.5 IP Camera Connection to the Server.....	17
3 Surveillance Software GUI.....	18
3.1 Login Window.....	18
3.2 Surveillance Window.....	21
4 Advanced Camera Settings.....	28
4.1 Setup Wizard.....	28
4.2 Device Status.....	28
4.3 Basic Settings.....	30
4.4 Network.....	37
4.5 Video.....	53
4.6 Detector.....	57
4.7 Record.....	63
4.8 PTZ (only FI9805E).....	67
4.9 Firewall.....	67
4.10 System.....	68
5 Playback.....	72
6 Appendix.....	74
6.1 Frequently Asked Questions.....	74
6.2 Default Parameters.....	82
6.3 Specification.....	82
6.4 CE & FCC.....	84

Security Warning

1. Please change the password of your camera regularly, using a combination of numbers, letters and special characters.
2. We recommend that you regularly update your camera to the latest available software and firmware versions to help ensure the best experience for your camera.

1 Overview

Outdoor HD IP Camera is an integrated wireless IP Camera with a color CMOS sensor enabling viewing in High Definition resolution. It combines a high quality digital video camera, with a powerful web server, to bring clear video to your desktop from anywhere on your local network or over the Internet.

The IP Camera supports the industry-standard H.264 compression technology, drastically reducing file sizes and conserving valuable network bandwidth.

The IP Camera is based on the TCP / IP standard. There is a WEB server inside which could support Internet Explorer. Therefore the management and maintenance of your device is simplified by using the network to achieve the remote configuration and start-up.

The camera is designed for outdoor surveillance applications such as courtyards, supermarket, and school. Controlling the IP camera and managing images are simplified by using the provided web interface across the network utilizing wireless connectivity.

Phone apps may be available for Android and iPhone users, please search and install app on app Store and Google Play for iOS and Android devices, then you can view your camera anywhere, anytime on your smart mobile devices.

1.1 Key Features

- ◆ Standard H.264 video compression algorithm to satisfy the transmission of high definition video in narrow bandwidth network
- ◆ 2.0 Mega-Pixel
- ◆ Supports IE / Firefox / Google / Safari browser or any other standard browsers
- ◆ Supports WEP, WPA and WPA2 Encryption
- ◆ Wi-Fi compliant with wireless standards IEEE 802.11b / g / n
- ◆ PoE compliant with PoE standards IEEE 802.3af
- ◆ IR LEDs for IR range up to 20m / 66ft
- ◆ Supports image snapshot

- ◆ Supports dual-stream
- ◆ Supports IR-Cut and the filter change automatically
- ◆ Embedded DDNS (dynamic domain name service) Service
- ◆ Supports remote viewing & record from anywhere anytime
- ◆ Multi-level users management with password protection
- ◆ Motion detection alert via email or upload image to FTP
- ◆ Supporting Third Party Domain name
- ◆ Providing Phone apps for Android and iPhone users
- ◆ Supports multiple network protocols: HTTP / HTTPS / RTSP / TCP / IP / UDP / FTP / DHCP / DDNS / UPNP / ONVIF
- ◆ Providing Central Management Software to manage or monitor multi-cameras
- ◆ Supports magic zoom
- ◆ Supports High Dynamic Range

1.2 PoE (Power over Ethernet)

The Network Camera is PoE-compliant, allowing transmission of power and data via a single Ethernet cable. Such as the following picture: connect the Network Camera to a PoE-enabled router / switch via Ethernet cable.

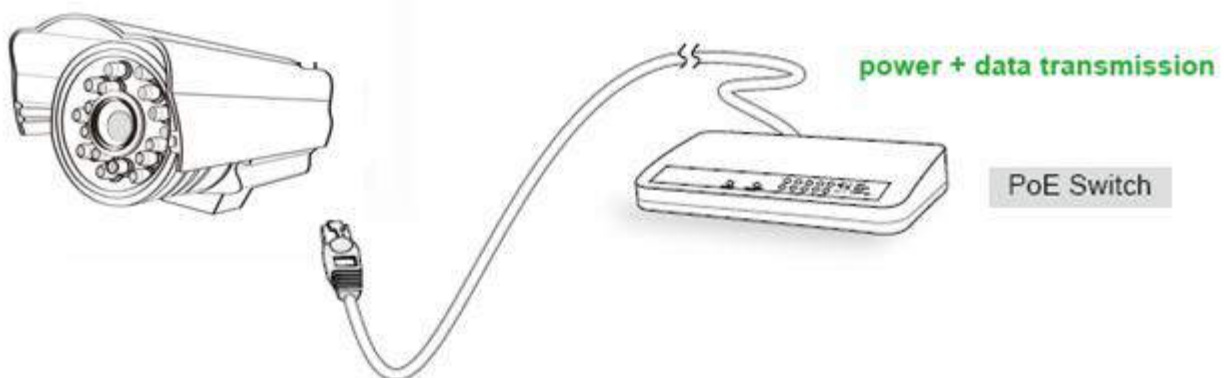

1.3 Read before Use

Please first verify that all contents received are complete according to the Package Contents listed below. Before the Network Camera is installed, please carefully read and follow the instructions in the Quick Setup Guide to avoid damage due to faulty assembly and installation. This also ensures the product is used properly as intended.

1.4 Packing Contents

● IP Camera * 1	● Quick Setup Guide * 1
-----------------	-------------------------

-
- DC Power Supply * 1
-

- Wi-Fi Antenna * 1
-

1.5 Physical Description

1.5.1 Front Panel

Front Panel

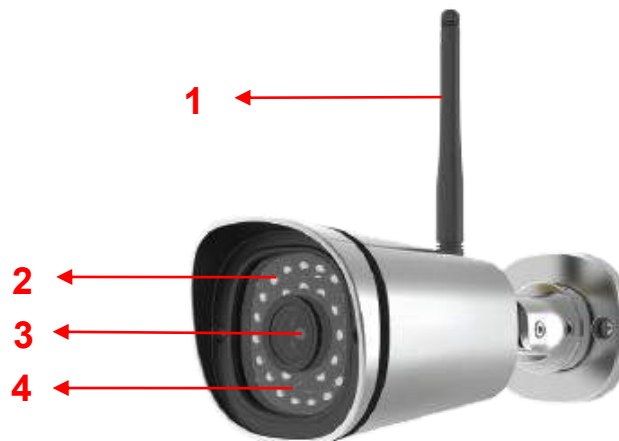

1 WIFI Antenna: Wireless Antenna

2 Infrared LED: 30 IR LEDs

3 LENS: CMOS sensor

4 Induction IC

1.5.2 Interface

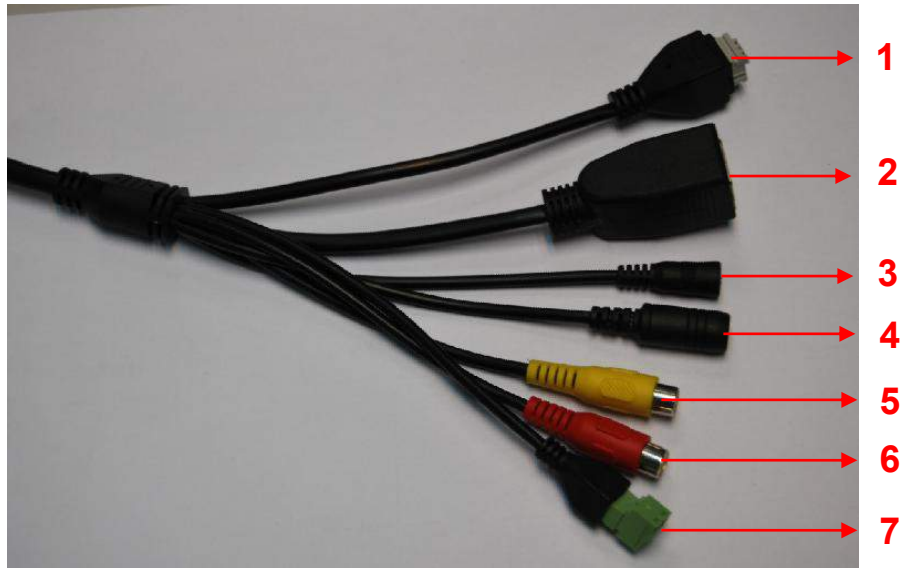

1 I / O alarm terminal block (Only FI9805E)

This network camera provides a I/O alarm terminal block which is used to connect to external input / output device.

The pin (there are four number in the terminal block from no. 1 to no. 4) definitions are as follows:

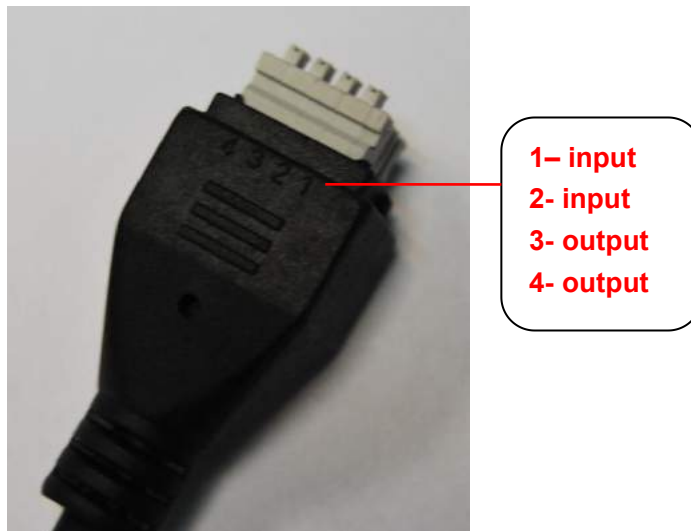

This camera supports I/O alarm, you can go to **Settings-Alarm - I/O** page to configure it.

2 LAN

10/100M adaptive Ethernet interface. Through this interface, IP camera can be connected with various network devices, such as hub, router, etc.

3 Reset button

Press and hold on the reset button for 5 seconds. Releasing the reset button, the password will back to the factory default administrator password. The default administrator user is admin with no password.

4 Power Interface

Connect the external power adapter, request for 12V / 2A or 12V / 1A power.

5 Audio input interface (Except FI9803EP / FI9803P / FI9903P)

The jack is used to plug external input device such as sound pick up device directly. Here microphone cannot directly insert to the interface, it must connect to adapter first.

6 Audio output interface (Except FI9803EP / FI9803P / FI9903P)

The jack is used to plug external output device such as loud speaker directly. Here microphone cannot directly insert to the interface, it must connect to adapter first.

7 RS485 Cradle head interface (Only forFI9805E)

This camera supports the standard 485 cradle head protocol (Pelco-D and Pelco-P). Please configure the RS485 protocol corresponding information first (go to **Settings- PTZ - RS485 Configuration** page and do settings), or else the cradle head may cannot work.

1.5.3 Bottom View

There are up to two labels located at the bottom of the camera, this is an important feature of original cameras. If your camera does not have labels, it may be a clone. Cloned cameras can not use original firmware and are not eligible for technical services.

1.6 SD Card Management

The record files of the IPC can be stored in the SD Card.

You need open the IP Camera, then plug the SD card into SD card slot inside the IP Camera.

When you plug in the SD card during the camera work process, please reboot the camera again, or else the SD Card may be cannot work well.

Insert Micro SD Card in the location shown below.

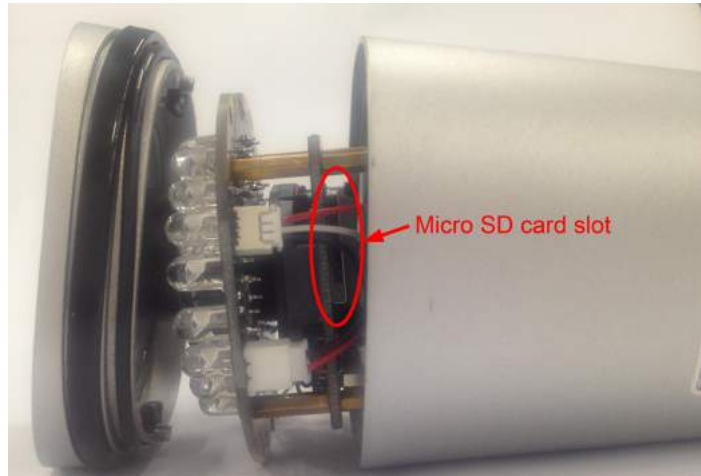

NOTE: When you re-install the camera, please ensure the tightness with the camera.

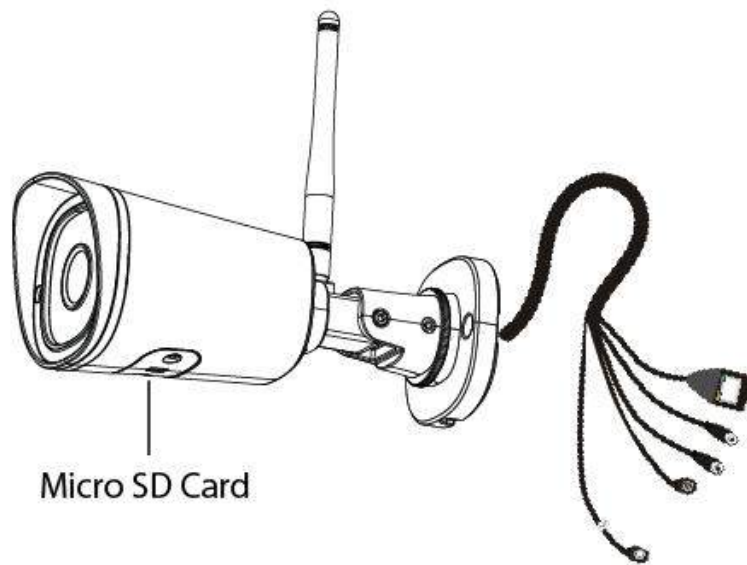

1.7 Wall Installation

Step 1: Screw the mount on the wall with the 3 screws provided.

Step 2: Install the camera on the mounting bracket with 1 screw to complete installation.

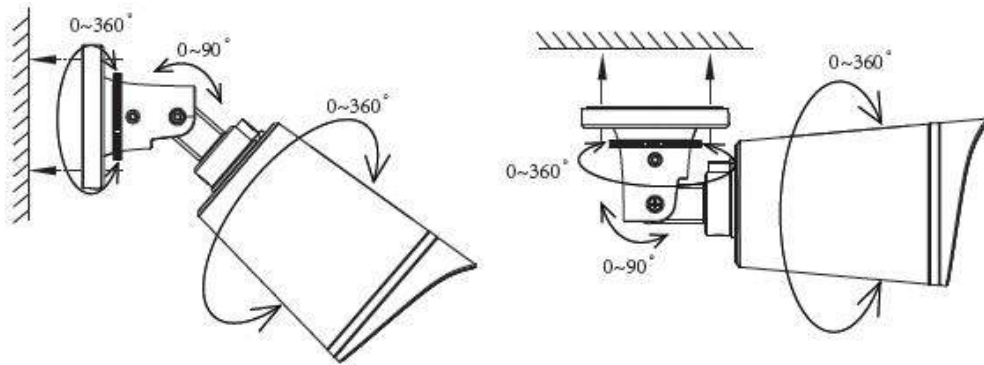

Fixate the camera on your preferred location and use screws to mount it. We have provided screws in the Packaging.

NOTE: Ensure that the rain or water will not reach the connector ports at the end of the pig tail wiring. These connectors are not weather-resistant.

The cable of an outdoor camera should, from the position where the cable is divided into several cables, be fitted dry. Install the cable into a waterproof junction box (1) or bring the cable indoors (2).

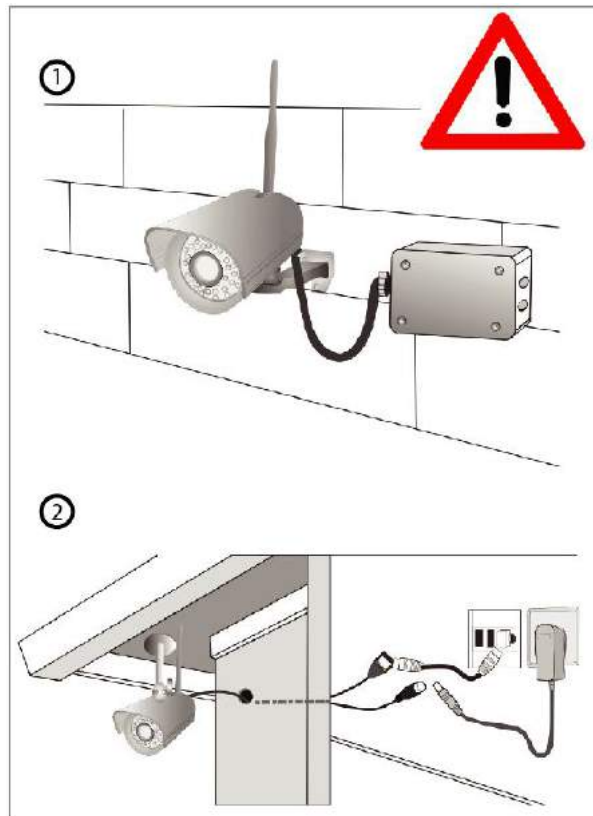

1.8 The Different Features between the Models Involved

Differences						
Model	Wireless	PoE (Power over Ethernet)	Alarm In / Out	Audio Input / Output	RS485	P2P
	√	×	×	√	×	√

2 Access the IP Camera

2.1 Hardware Connection & Software Installation

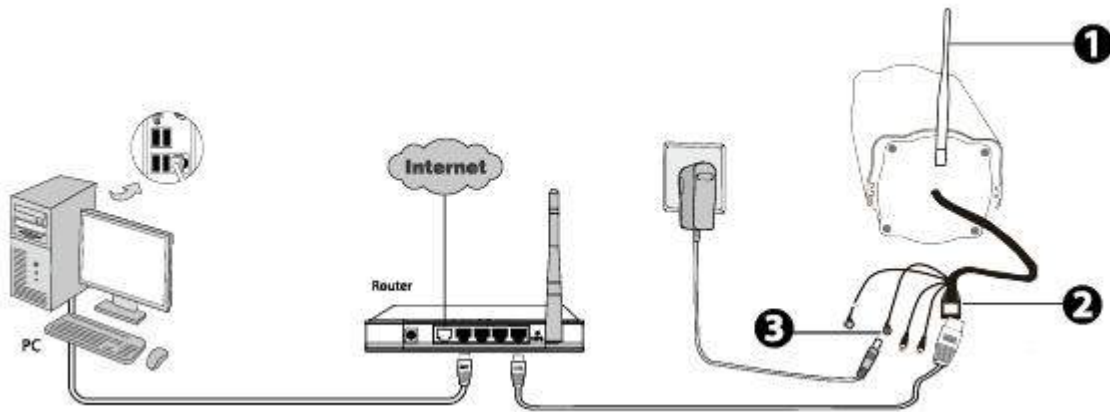

1. Mount the antenna and make it stand vertically (Only for the device with external antenna).
2. Connect the camera to the LAN network (Router or Switch) via network cable.
3. Connect the power adapter to the camera.
4. Download the “Equipment Search Tool” tool to your computer, the icon shows as below:
Windows: https://www.larsonelectronics.com/images/upload/SearchTool-v1.0.0.7_win.zip
Mac: https://www.larsonelectronics.com/images/upload/SearchTool-V0.0.0.5_mac.zip



NOTES:

- If your computer (Windows OS) supports autorun function, you can find the corresponding file in the opened control panel.

2.2 Access the Camera In LAN

2.2.1 Wired Connection

The camera supports HTTP and HTTPS protocols, you can access the camera in two ways.

(1) Http:// LAN IP + Http Port No.

The default HTTP port NO. is 88. Double click the Search Tool icon to run, and it should find the camera's IP address automatically after you plug in the network cable.

Camera Name	IP Address	Device ID	Type
Anonymous	Http://192.168.1.105:88	A0E270F49D29	IPC

Double click the IP address of the camera; the camera login page should be open in your default browser.

(2) Https:// LAN IP + Https Port no.

The default HTTPS port NO. is 443. You can use the URL to access the camera: https:// LAN IP + HTTPS port NO.

Go to **Settings - Network - Port** panel, you can see and change the HTTP and HTTPS port NO.

HTTP Port	<input type="text" value="88"/>
HTTPS Port	<input type="text" value="443"/>
ONVIF Port	<input type="text" value="65533"/>

NOTE: When logging in for the first time, you will need to download and install the add-on.

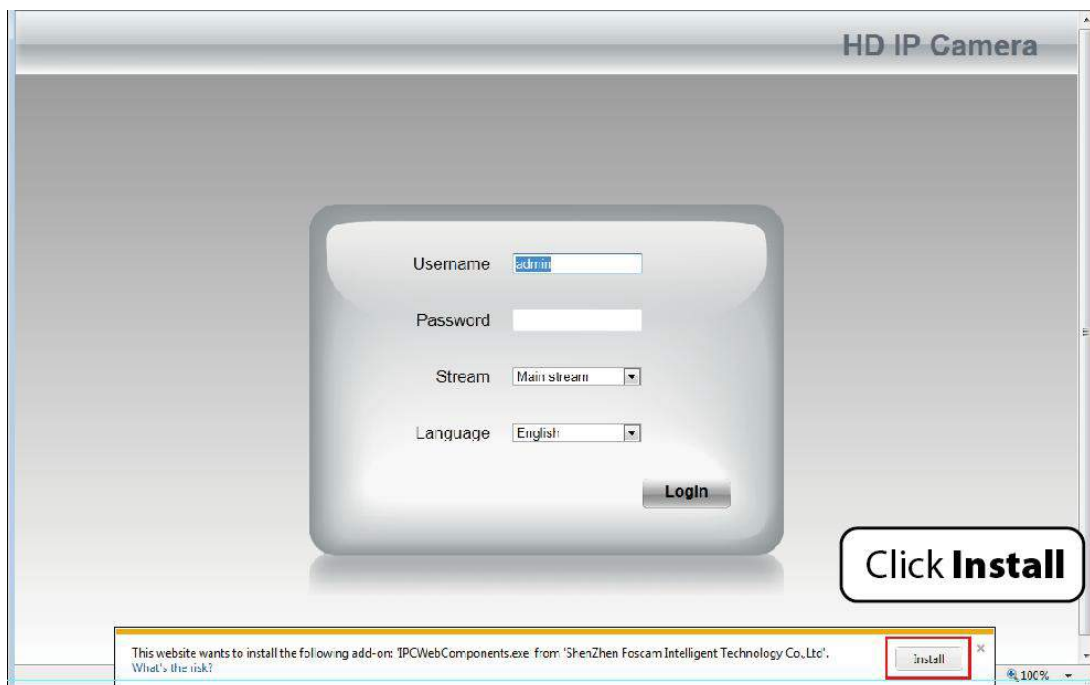

2.2.2 Wireless Connection

Only some models support EZLink wireless connection , please refer to the Quick Setup Guide.

2.3 Access the Camera in WAN

2.3.1 Static IP Addresses

Users who have static IP addresses do not need to set DDNS service settings for remote access. When you have finished connecting the camera using the LAN IP address and port forwarding, you can access the camera directly from the Internet using the WAN IP address and port number.

How to Obtain the WAN IP address from a public website ?

To obtain your WAN IP address, enter the following URL in your browser: <http://www.whatismyip.com>. The webpage at this address will show you the current WAN IP.



Access your IP Camera from the Internet

You can access the IP Camera from the Internet (remote access). Enter the WAN IP address and port number in your standard browser. For example, you would enter `http:// 183.37.28.254:88`

2.3.2 Remote Access

If you want to access your camera by web browser outside of your LAN, you need to configure following configurations.

1. Choose **Settings** on the top of the camera web page, then go to the **Network > IP Configuration** section on the left side of the screen, then uncheck the Obtain IP DHCP.

IP Configuration

Obtain IP From DHCP

IP Address	192.168.1.10
Subnet Mask	255.255.255.0
Gateway	192.168.1.1
Primary DNS Server	211.162.78.1
Secondary DNS Server	211.162.78.3

IP Address: Set this in the same subnet as your computer , or keep it as default.
 Subnet Mask: Keep it as default.
 Gateway and DNS Server: Set it to the IP address of your router.

2. Enable UPnP and DDNS in the camera's settings page. We recommend you to use the DDNS by factory default.

UPnP

Enable UPnP Yes

Select Yes and click Save.

DDNS

Enable DDNS

Manufacturer's DDNS

Manufacturer's DDNS

Third Party DDNS

DDNS Server

Domain

Click Enable DDNS and click Save.
 The content in the Manufacture's DDNS column is the domain name of your camera.

3. You can see the port of your camera here. If you want to set Remote Access for several cameras on the same network, you will need to change the HTTPS port for each camera.

Port

HTTP Port	88
HTTPS Port	443
ONVIF Port	888
RTSP port	554

4. If the UPnP of the router has been enable, you do not need to perform following steps. Otherwise, you need to select one of the following methods to configure port forwarding on your router. For these steps, we will

be using the TP-LINK brand wireless router as an example.

- **If there is a UPnP function in your router:**

Choose **Forwarding > UPnP**, make sure that the Current UPnP Status is Enabled.

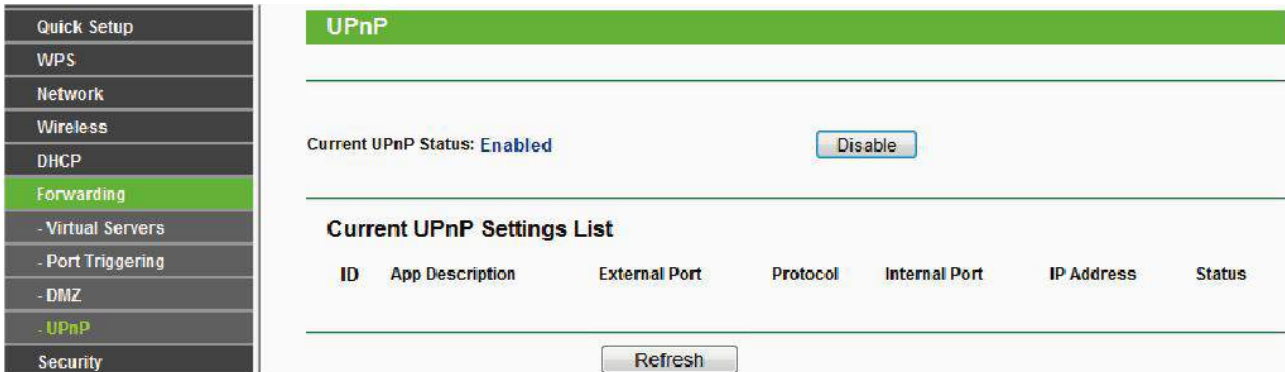

- **If there is no UPnP function in your router:**

You need to manually add port (HTTPS port) forwarding, refer to the following steps. You need go to the **Forwarding > Virtual Servers** panel for setup.

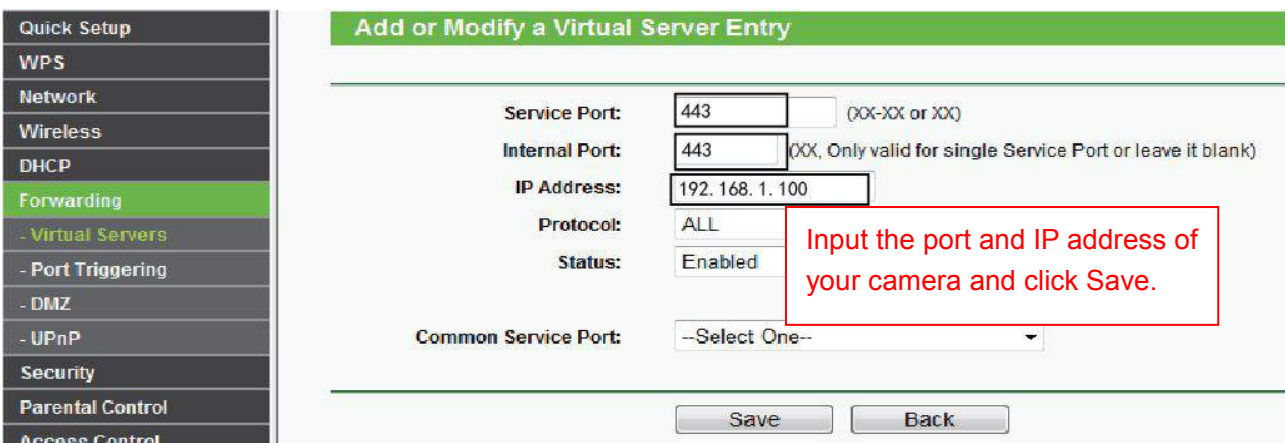



5. Now you can access your IP camera by `https://domain name: HTTPS port` via the Internet.

2.4 Using the VLC Player

This camera supports RTSP streaming, here you can view the camera using VLC player.

RTSP URL [rtsp:// \[user_name\]:\[password\]@IP:port number/videosream](rtsp://[user_name]:[password]@IP:port_number/videosream)

The part in the square brackets may be omitted.

user name & password:

The user name and password to access the camera. This part can be omitted.

IP: WAN or LAN IP address.

port number: If there is the RSTP port number on the Port page, you must only use RTSP port number. otherwise, you must only use http port number.

Videostream: Here support three modes: videoMain, videoSub and audio. When the network speed is bad, here you had better select videoSub. If you select audio, you can only hear the sound but cannot see the video.

For example:

IP: 192.168.1.11

Port number: 88

User name: admin

Password: 123

Here I can enter one of the following URLs in the VLC.

1. `rtsp://admin:123@192.168.1.11:88/videoMain`
2. `rtsp:// @192.168.1.11:88/videoMain`
3. `rtsp://:123@192.168.1.11:88/videoMain`
4. `rtsp://admin@192.168.1.11:88/videoMain`

Open the VLC, and go to Media Open Network Stream option, then enter the URL into VLC.

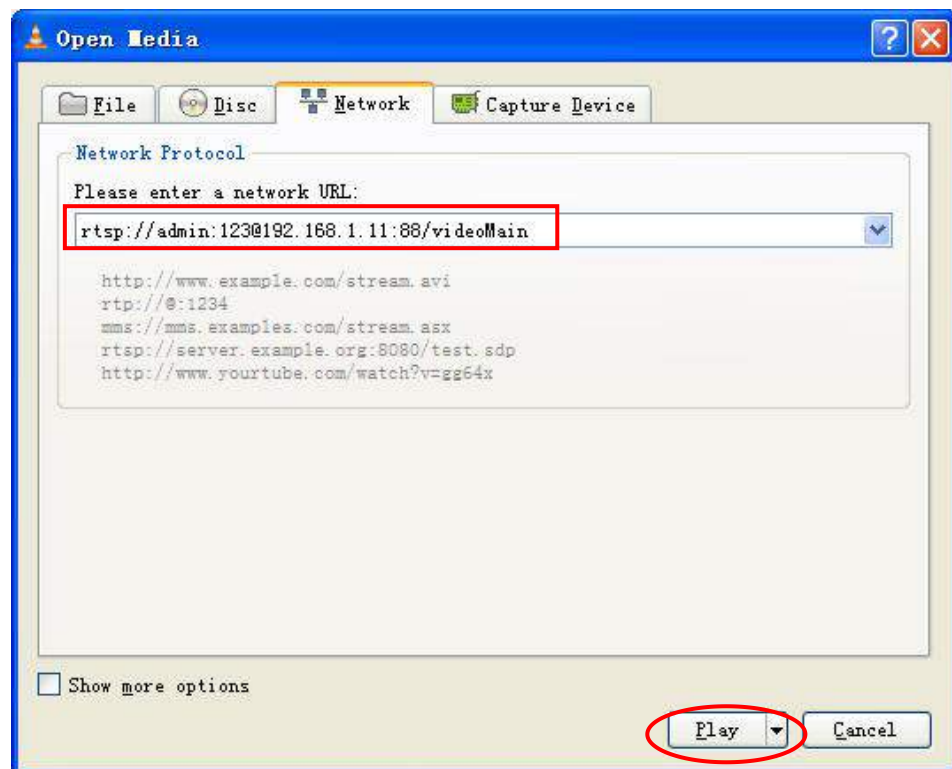
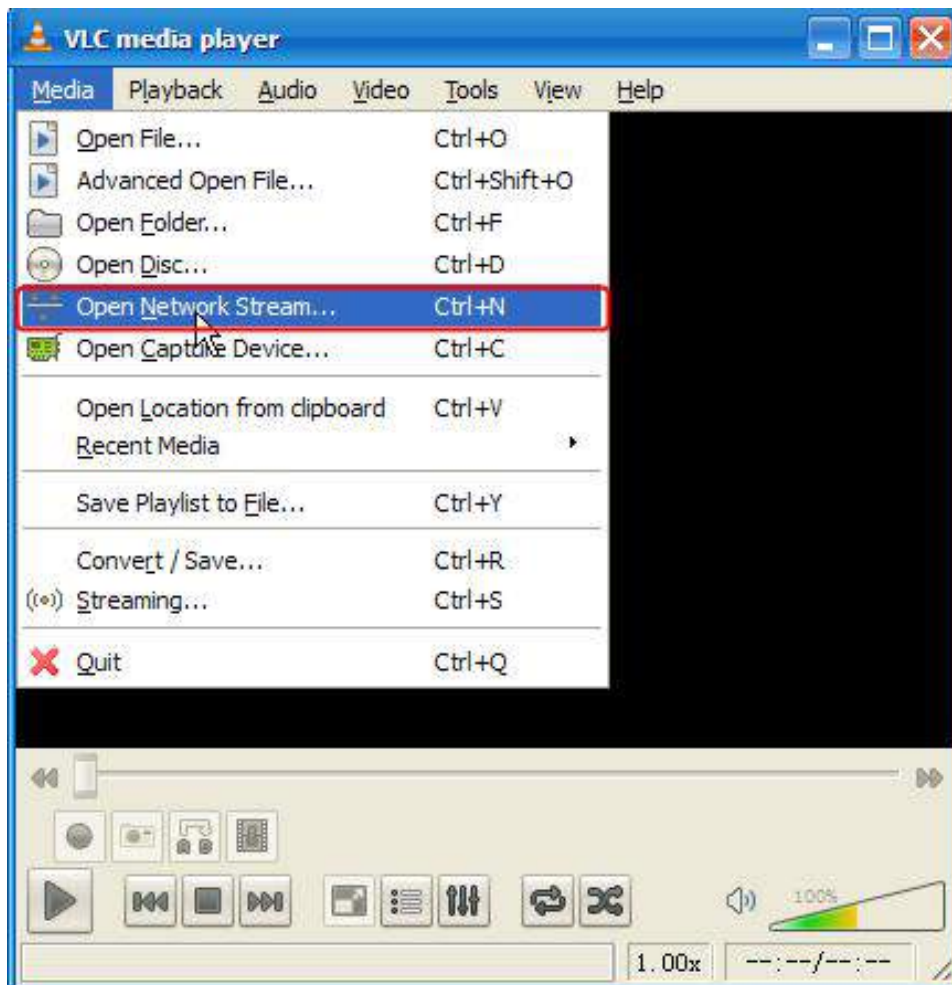

Sometimes you may need to enter the user name and password again. Click OK and you can see the real-time

preview.

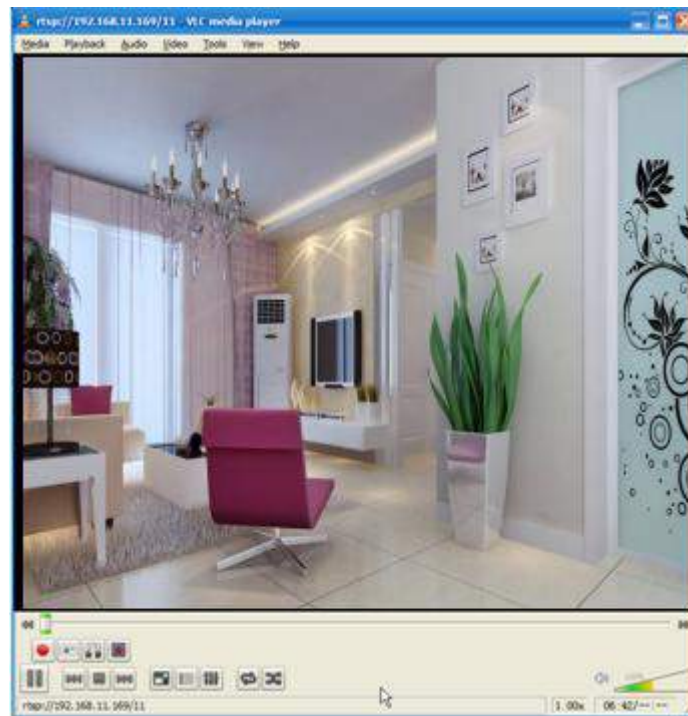

If you cannot play the video in the VLC player, please check the port mapping.

NOTE: If you modify the camera's username or password, you had better reboot the camera, or else the new username and password cannot take effect when you enter the authentication in the VLC.

2.5 IP Camera Connection to the Server

Device supports ONVIF 2.2.1 protocol, You can easily access the NVR with ONVIF or server with ONVIF.

3 Surveillance Software GUI

Please refer to the section 2.1 if you install the camera for the first time. You can start to learn about software operation after finish quick installation.

3.1 Login Window

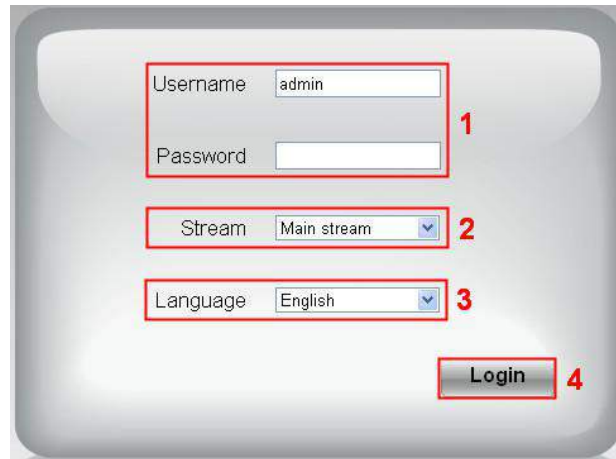

Section1 Enter the Username and password

The default administrator username is admin with no password, please change the password at first using and prevent unauthorized users login the camera.

Section2 Stream

The camera supports two stream modes: Main stream and sub stream. If you want to access the camera form LAN, here you can select Main stream. If you want to access the camera from Internet, here we recommend sub stream.

NOTE: When the network bandwidth is bad you'd better select Sub Stream and the video will be more fluent.

Section3 Select the language

You can select the language you need by clicking on the language dropdown list.

Section4 login the camera

Click **Login** button.

NOTE: When setting up your camera for the first time, it will request that you modify the default username and / or password if both are still set to default. Input the new username and password, click **Modify** to complete the modification. You will now use the new username and password to login the camera in the future.

After logging in for the first time, you will go to **Setup Wizard** automatically. Here you can set the basic parameters of camera, such as camera name, camera time, wireless settings, IP configuration.

Country: Select the country.

Device Name: You could give name for your camera.

System Time: Select the time zone you need to set the date, time,format, etc.

Setup Wizard

Step 3 of 5 - Camera Time

Time Zone: (GMT) Greenwich mean time; London, Lisbon, ▾

Sync with NTP server

NTP Server: Auto ▾

Device Time: 2016-9-7 09:18:38
Sync with PC/Terminal

Date Format: YYYY-MM-DD ▾

Time Format: 24-hour ▾

use DST

From: April ▾ first ▾ Sunday ▾ 2 ▾ : 0 0

To: October ▾ the last one ▾ Sunday ▾ 2 ▾ : 0 0

Ahead Of Time: 0 ▾ Minute

Previous Next

Wireless networks: Click **Scan**, find the SSID of your wireless router, select and enter the password.

Setup Wizard

Step 4 of 5 - Wireless Settings

Wireless Network List 1 Scan

SSID(Network Name)	Encryption	Quality
ADlink-heng	WPA/WPA2	
fusha+TP-LINK_403E	WPA/WPA2	
app_net	WPA/WPA2	
APP210	WPA/WPA2	
product-2.4GHz	WPA/WPA2	
TP-LINK_3742	WPA/WPA2	
docdev2	WPA/WPA2	
TP-LINK_A5DC	Unencrypt	
Hi-WiFi-1307	WPA/WPA2	
1234567890987654321	WPA/WPA2	

2

SSID: product-2.4GHz

Encryption: WPA/WPA2 ▾

Password: ●●●●●●

3

The maximum password length is 63, including numbers, letters and symbols

Previous Next

IP: Set IP address of the camera. You could choose to obtain an IP automatically or set the IP address according to your needs.

Setup Wizard

Step 5 of 5 - IP Configuration

Obtain IP From DHCP

IP Address	192.168.1.4
Subnet Mask	255.255.255.0
Gateway	192.168.1.1
Primary DNS Server	192.168.8.8
Secondary DNS Server	211.162.78.2

NOTE: It needs about 1 minute to connect the camera to your router.

3.2 Surveillance Window

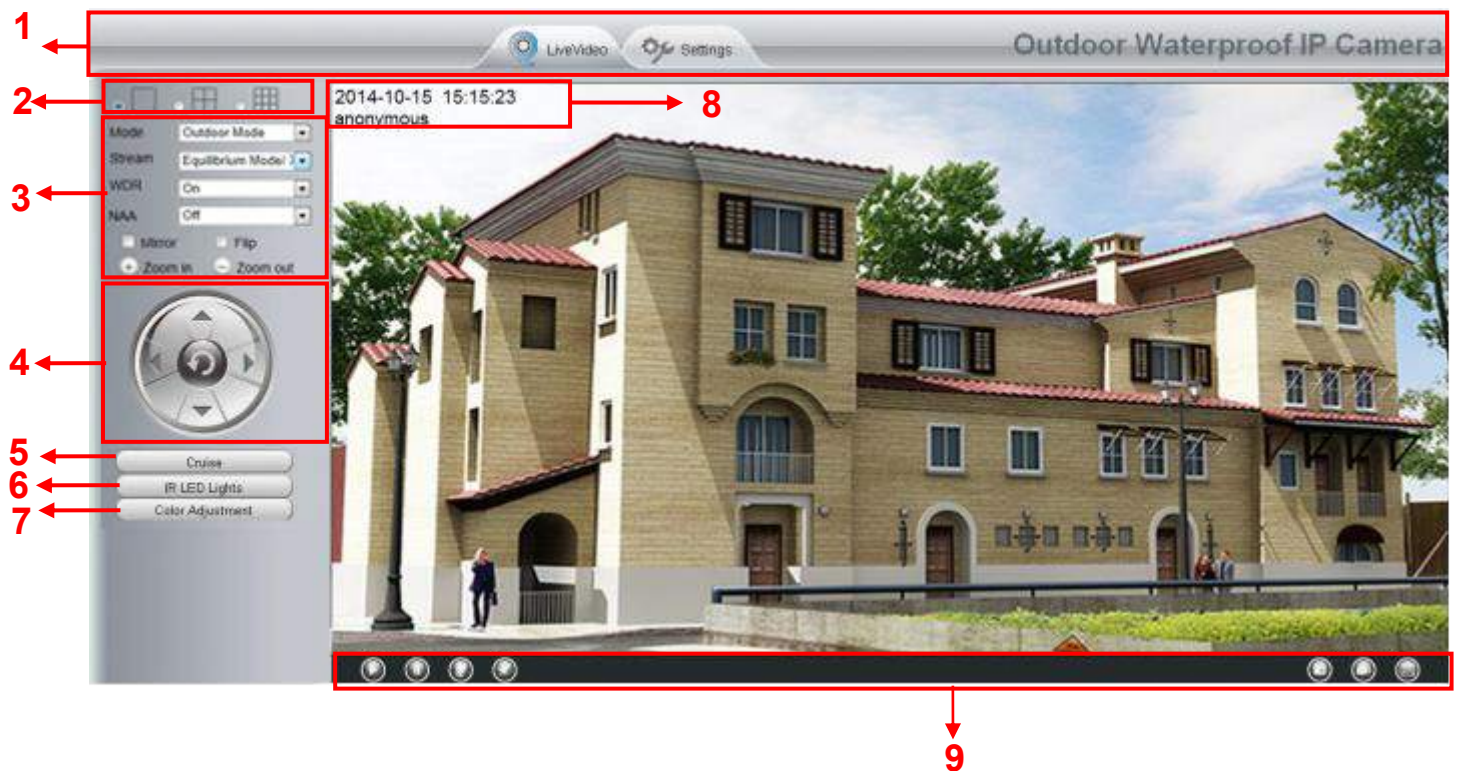

Differences

Model	Playback	WDR	Pan / Tilt Control	Zoom out / Zoom in	Cruise
	√	√	×	√	×

Section1 Logo / LiveVideo / Settings buttons



: Path to surveillance window. Click this button and back to the surveillance window



: Path to Administrator Control Panel, Click it, and it will lead to Administrator Control Panel and do advanced settings.

Section2 Multi-Device Window

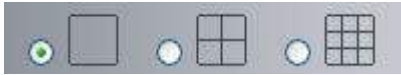

The firmware inside the camera supports up to maximum of 9 cameras being monitoring at the same time. You can add other cameras in multi-camera panel.

Section3 Mode / Stream / WDR / NAA / Mirror / Flip buttons

Mode

- 1) 50Hz -----Indoor surveillance (Region: Europe, China)
- 2) 60Hz -----Indoor surveillance (Region: USA, Canada)
- 3) Outdoor Mode-----Outdoor surveillance

Stream

The default stream supports multiple modes, For example: Equilibrium Mode / 720P / 15fps / 512K meanings: **Stream type / Resolution / Maximum frame rate / Bit rate**. (Different models support different specific mode.)

1) Stream type no. Identify the stream type.

2) Resolution

The bigger the resolution, the better of the image quality is. If you are accessing the camera via internet and want to get more fluent video streaming, please select resolution VGA.

3) Maximum frame rate

The maximum frame rate is 30 fps. You should lower frame rate when the bandwidth is limited. Normally, when the frame rate above 15, you can achieve fluently video. The maximum frame rate for each model is different, please refer to [6.3 Specification](#).

4) Bit Rate

Generally speaking, the larger the bit rate is, the clearer video will become. But the bit rate configuration should combine well with the network bandwidth. When the bandwidth is very narrow, and bit rate is large, that will lead to video cannot play well.

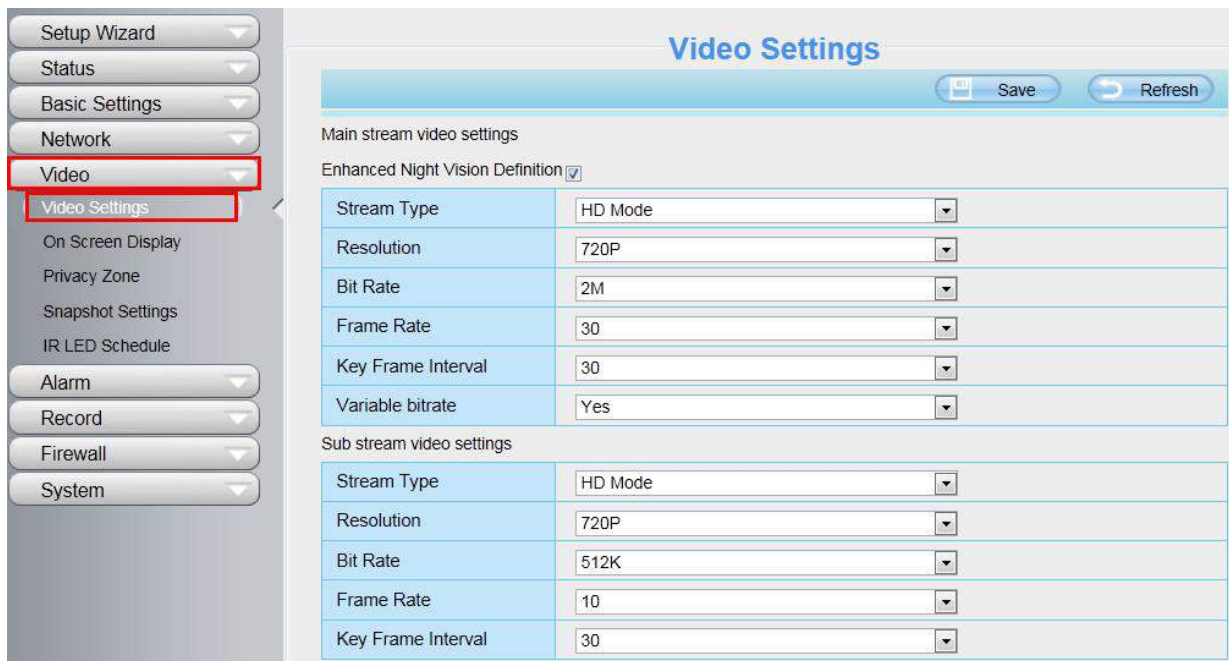

You can reset the stream type on **Settings > Video > Video Settings** panel.



WDR stands for High Dynamic Range. It usually refers to the method of capturing images having "greater dynamic range between the lightest and darkest areas of an image than current standard digital imaging methods or photographic methods". You can select **ON** from the dropdown list under sunlight or with bright background.

NAA (except F19804W / F19805W / F19805E): NAA (Network Auto-Adaptability) can make IP Camera changing the real-time rate to adapt different network conditions, which can supply better preview experience. It is OFF as default.

"Zoom in" or "Zoom out"

Device Support 8x zoom feature, click  or , The focal length of the camera lens will be larger or shrink, you can adjust the focus distance to the target object size, access to high-definition screen.

Section4 Pan / Tilt Control (only F9805E)

When via RS485 interface to connect an external PTZ device, you can use this feature.



1-----Up control button,
3-----Left control button,

2-----Down control button,
4-----Right control button,



Click this button and go to center

Section5 Cruise settings (only certain models)

If via RS485 interface to connect an external PT device, you can use this feature.



The default cruise tracks have two types: Vertical and Horizontal.

Vertical: The camera will rotate from up to down.
Horizontal: The camera will rotate from left to right.

: Start cruise. : Stop cruise.

If you want to define or change the cruise trace, please go to **Settings**→ **PTZ**→ **Preset Settings** panel.

How to do cruise?

Firstly: Select one track in the track drop-down list



Secondly: Click Start cruise button, the camera will cruise following the predefined path.

Thirdly: Click stop button and finish cruising.

Section6 IR LED Lights

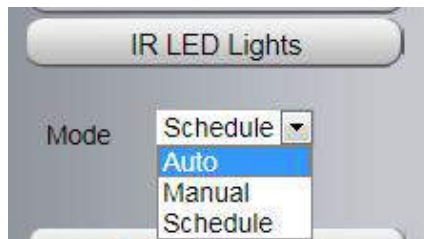

Click Infra led and there are three modes to adjust the infrared led: Auto, Manual and Schedule.

Auto: Select it and the camera will adjust the infra led (on or off) automatically.

Manual: Select it and turn off the infra led manually.

Schedule: Select it and the IR led light will be off at the schedule period. If you want to define or change the IR led lights schedule time, please go to **Settings** > **Video** > **IR LED Schedule** page.

Section7 Image quality settings

In this page, you can tune Hue, Brightness, Contrast, Saturation, and Sharpness to get higher quality.



Section8 OSD

If you have added time and camera name in the video, you can see it in the live window.

Go to **Settings > Basic settings > Camera name** panel, and you can change another device name. The default device name is anonymous.

Go to **Settings > Basic settings > Camera time** panel and adjust the device time.

Go to **Settings > Video > On Screen Display** panel, you can add or no add OSD.

Section9 Play / Stop / Talk / Audio / Snap / Record / Full screen button



1-----Play Click it to play the video of the camera

2-----Stop Click it to stop the video of the camera

3----- Talk Click the button and the icon will become to , then talk to the microphone that connected with PC, people around the camera can hear your voice if the camera has connected with audio output device. Click the icon again and stop talking.

4----- Audio Click the button and the icon will become to , you can hear the sound around the camera if the camera has connected with other audio input device through the Audio Input port of the camera, Click the icon again and stop audio.

5----- Volume Click the button and the icon will become to , you can set the volume.

6----- Snap Click it to make snapshot and it pop up a window which picture you snapshot, right click in the window and save the picture to anywhere you want.

7----- Record Click the icon  and the camera start recording, you can see a green dot in the live window. Click again and stop recording. The default storage path is C:\IPCamRecord. You can change the storage path: Go to **Settings > Record > Storage Location** panel.

8-----Full Screen Click it to make full-screen, or you can double click the surveillance screen to make full-screen. Double click again and exit full-screen.

Onscreen Mouse Control

Right click the mouse and you can adjust the screen ration, full screen and Zoom up.



Keep Ration: Select it and the camera will adjust the size of live window based on the computer monitor automatically.

Sometimes there is a black border around the video, please select Keep ration to get a better visual quality.

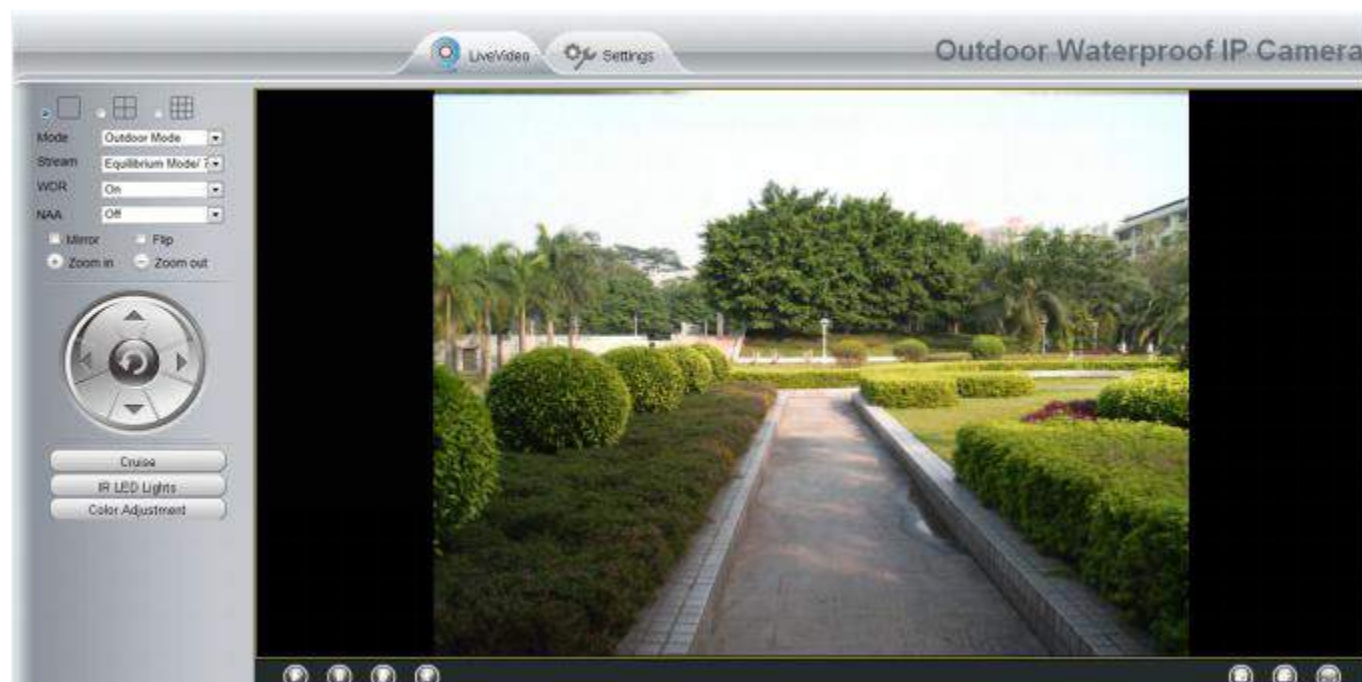

Full Screen: Select it and Click it to make full-screen, press ESC and exit full-screen.

Zoom Up / Down: Click it and the live view will be digital zoomed up, then click Zoom Down and the live view back to original size.

NOTES:

1. This camera don't support Pan / Tilt function, so here can not allow to use Screen PTZ.
2. For Mac OS, the plugin cannot support Onscreen Mouse function, so you cannot allow to use it.

4 Advanced Camera Settings

Click the button **Settings**, goes to Administrator Control Panel to make advanced camera settings.

4.1 Setup Wizard

The way to set it, you could refer to section 3.1.



4.2 Device Status

Device Status contains four columns: Device Information, Device Status, Session Status and Log, it will show you various information about your camera.

4.2.1 Device Information

Refresh	
Camera Model	F19804W
Camera Name	anonymous
Camera ID	00841F19804W
Camera Time	2013/10/21 16:12:07
System Firmware Version	1.4.1.7
Application Firmware Version	1.14.1.20
Plug-In Version	2.0.1.6

Camera Model: The model of the device.

Camera Name: The Device Name is a unique name that you can give to your device to help you identify it. Click Basic Settings and go to Device Name panel where you can change your camera name. The default device name is anonymous.

Camera ID: Display the MAC address of your camera. For example Device ID is 008414350787, the same MAC ID sticker is found at the bottom of the camera.

Camera Time: The system time of the device. Click Basic Settings and go to Camera Time panel and adjust

the time.

System Firmware Version: Display the System Firmware version of your camera.

Application Firmware Version: Display the application firmware version of your camera.

Plug-In Version: Display the plug-in version of your camera

4.2.2 Device Status

On this page you can see device status such as Alarm status, NTP / DDNS status, WIFI status and so on.



Refresh	
Alarm Status	Disabled
NTP Status	Disable
DDNS Status	Disable
UPnP Status	Success
WiFi Status	Not connected
IR LED Status	Off

4.2.3 Session Status

Session status will display who and which IP is visiting the camera now.



Session status

Refresh	
User name	IP address
admin	192.168.1.102
admin	218.17.160.187

4.2.4 Log

The log record shows who and which IP address accessed or logout the camera and when.

Click the page number and go to the corresponding page to see more logs .

Fill in one page number, click Go button and go to the corresponding page .

NO.	Time	User	IP	Log
1	2014-01-09 14:12:35	root	127.0.0.1	Detected motion alarm
2	2014-01-09 14:11:58	root	127.0.0.1	Detected motion alarm
3	2014-01-09 14:11:58	root	127.0.0.1	Detected motion alarm
4	2014-01-09 14:11:24	ioscam	192.168.8.2	User off line
5	2014-01-09 14:11:13	root	127.0.0.1	Detected motion alarm
6	2014-01-09 14:11:13	root	127.0.0.1	Detected motion alarm
7	2014-01-09 14:10:44	root	127.0.0.1	Detected motion alarm
8	2014-01-09 14:10:28	root	127.0.0.1	Detected motion alarm
9	2014-01-09 14:09:41	root	127.0.0.1	Detected motion alarm
10	2014-01-09 14:08:31	root	127.0.0.1	Detected motion alarm

Reboot the camera and clear the log records.

4.3 Basic Settings

This section allows you to configure your Camera Name, Camera Time, Mail, User Accounts and Multi-Device.

4.3.1 Camera Name

Default alias is anonymous. You can define a name for your camera here such as apple. Click **Save** to save your changes. The alias name cannot contain special characters.

Camera Name: anonymous

Save Refresh

4.3.2 Camera Time

This section allows you to configure the settings of the internal system clocks for your camera.

Click **Setting > Basic Setting > Camera Time** to enter the **Camera Time** setting page.

Time Zone: Select the time zone for your region from the drop-down menu.

Sync with NTP server: Network Time Protocol will synchronize your camera with an Internet time server. Choose the one that is closest to your camera.

Sync with PC / Terminal: Select this option to synchronize the date and time of the Network Camera with your computer.

Manually: The administrator can enter the date and time manually. Please select the date and time format.

use DST: Select the **use DST** (Daylight Saving Time, to set the clock ahead of the real-time), then set the start time and end time of the DST, select the daylight saving time from the drop-down menu at last.

Click Save button to submit your settings.

NOTE: If the power supply of camera is disconnect, you need set the camera's time again.

4.3.3 User Accounts

Here you can create users and set privilege, **visitor**, **operator** or **administrator**. The default administrator user accounts are admin with a blank password.

NO.	Username	Privilege
1	foscam	Administrator
2		
3		
4		
5		
6		
7		
8		

How to change the password?

Firstly, select the account which you want to change the password, then select **Change Password**, enter the old password and the new password, lastly click modify to take effect.

User Accounts

Refresh

NO.	Username	Privilege
1	foscam	Administrator
2		
3		
4		
5		
6		
7		
8		

Username:

Password:

New password:

Security Level:

Confirm the password:

Privilege:

Change username

Change password

The maximum username length is 20, including numbers, letters and symbols _ - @ \$ *
 The maximum password length is 12, including numbers, letters and symbols ~ ! @ # % ^ * () _ + { } : " | < > ? ` - ; ' \ , . /

How to add account ?

Select one blank column, then enter the new user name, password and privilege, last click Add to take effect. You can see the new added account on the Account list.

User Accounts

Refresh

NO.	Username	Privilege
1	foscam	Administrator
2		
3		
4		
5		
6		
7		
8		

Username:

Password:

Security Level:

Confirm the password:

Privilege:

Change username

Change password

The maximum username length is 20, including numbers, letters and symbols _ - @ \$ *
 The maximum password length is 12, including numbers, letters and symbols ~ ! @ # % ^ * () _ + { } : " | < > ? ` - ; ' \ , . /

User Accounts

NO.	Username	Privilege
1	foscam	Administrator
2	test	Visitor
3		
4		
5		
6		
7		
8		

Username:

Privilege:

Change username

Change password

The maximum username length is 20, including numbers, letters and symbols _ - @ \$ *
 The maximum password length is 12, including numbers, letters and symbols ~ ! @ # % ^ * () _ + { } : " | < > ? ` - ; ' \ . , /

Delete: Select the account which you want to delete, then click Delete button to take effect.

NOTE: The default administrator account cannot be deleted, but you can add other administrator users.

4.3.4 Multi-Camera

If you want to view multi-surveillance screens on one window, you need to login one camera, and set it as the main device, and do Multi-Device Settings, add other cameras to the first one camera. Before you do multi-cams settings, you need to assign different port such as 81, 82, 83, 84, 85, 86, 87, 88 to the cameras if there is 8 cams installed.

The firmware within the camera can support a maximum of 9 devices monitoring all at the same time. This page you can both add MJPEG and H.264 series cameras to the first camera and view multi-surveillance screen on one window.

Add cameras in LAN

In Multi-Device Settings page, you can see all devices searched in LAN. The 1st Device is the default one. You can add more cameras in the list in LAN for monitoring. The camera's software supports up to 9 IP Cameras online simultaneously. Click The **2nd Device** and click the item in the Device List in LAN, the Alias, Host and Http Port will be filled in the boxes below automatically. Enter the correct username and password then click **Add**. Add more cameras in the same way.

Multi-Camera

Cameras On LAN: FI9821P(172.16.0.94), 1111(172.16.1.71), FOSCAM(172.16.0.27), **anonymous(172.16.0.179)**, FOSCAM(172.16.0.195)

The 1st Camera: This Camera

The 2nd Camera

Camera Model	H264
Camera Name	anonymous
Host	172.16.0.179
HTTP Port	80
Media Port	80
Username	admin
Password	

The 3rd Camera: None

The 4th Camera: None

1 Click it, camera model, alias, host and HTTP Port will be filled in the following boxes automatically .

2 Enter the User name and password of the 2nd camera .

3 Click Add to take effect .

Camera Model: Our Company produces two series cameras: MJPEG and H.264. Here will show you which series the camera belongs to.

Cameras On LAN: anonymous(192.168.11.193), FI9821W for ebuyer (192.168.11.241), **anonymous(192.168.11.203)**, anonymous(192.168.11.243)

The 1st Camera	This Camera
The 2nd Camera	anonymous(192.168.11.203)
The 3rd Camera	FI9821W for ebuyer (192.168.11.241)
The 4th Camera	anonymous(192.168.11.203)
The 5th Camera	None
The 6th Camera	None
The 7th Camera	None
The 8th Camera	None
The 9th Camera	None

Note: If you want to access your camera remotely, make sure you are able to access it seperately through a browser.

Back to Surveillance Windows, and click Four Windows option, you will see four cameras you added.

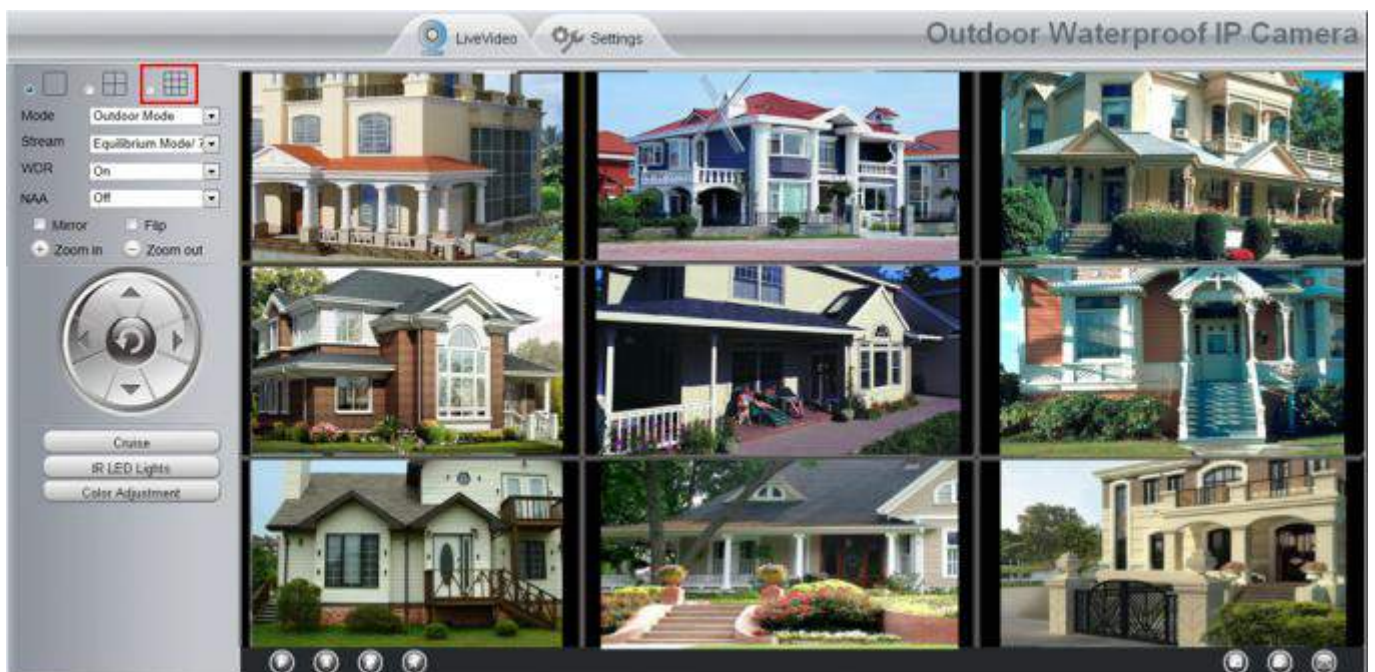
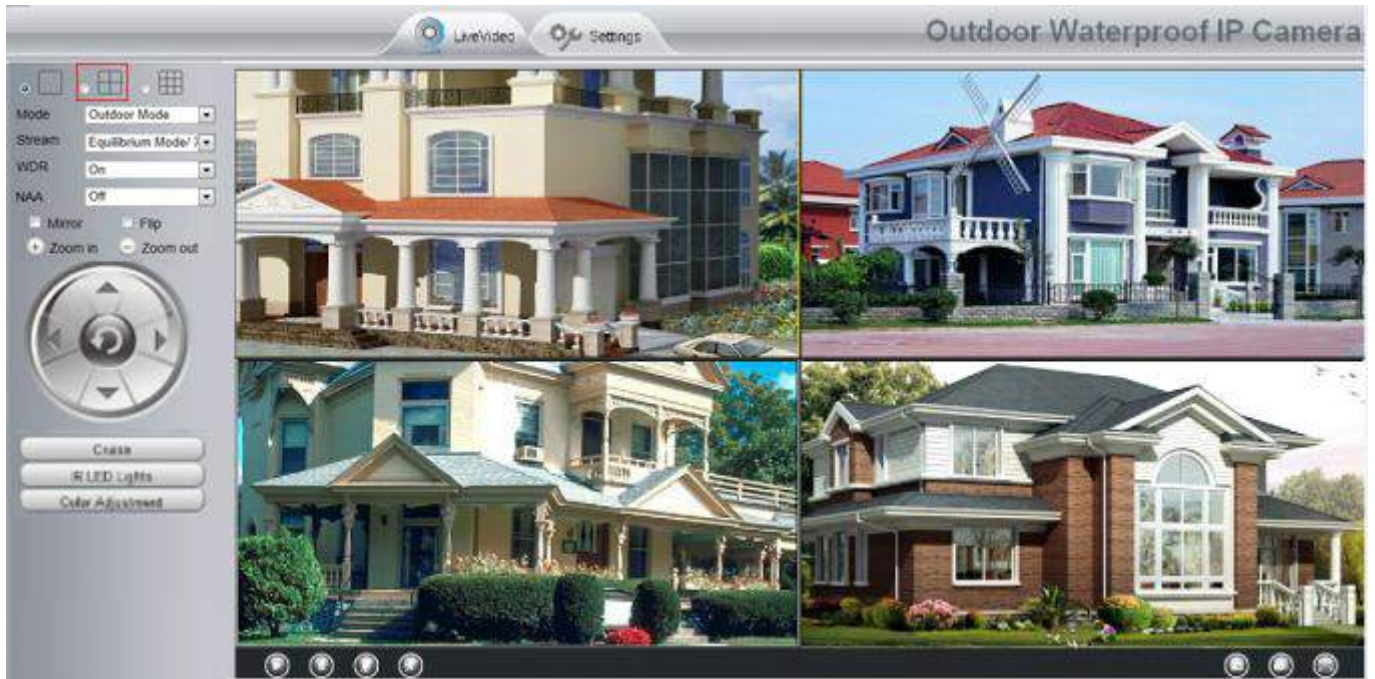

Add cameras in WAN

If you want to view all cameras via the internet (remote computer), you will need to add them using DDNS domain name. Firstly, make sure all of the cameras you added can be accessed through the internet. (Read How to configure DDNS settings in chapter [4.4.4 DDNS](#))

Login to the first camera using a DDNS domain name and port.

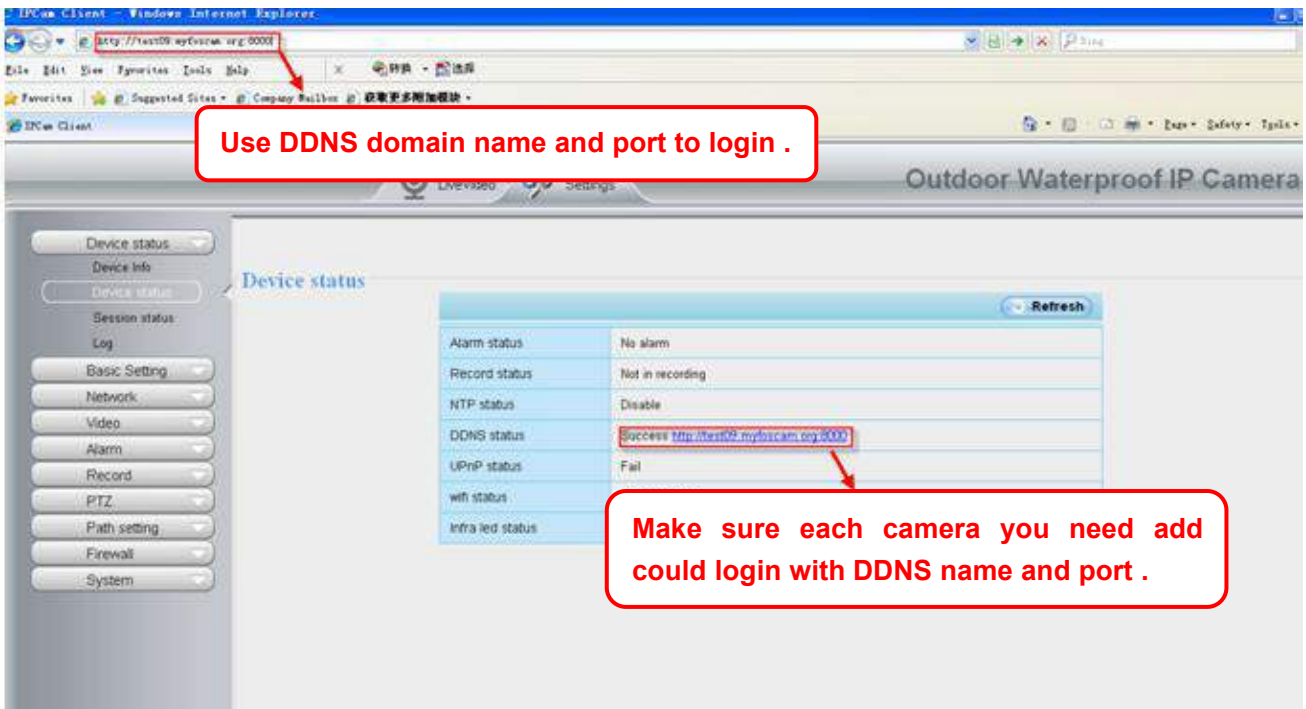

Click Multi-Device Settings. Choose The 2nd Device. Fill in the 2nd camera's name, DDNS domain name, port number. Enter user name and password and then choose Add.

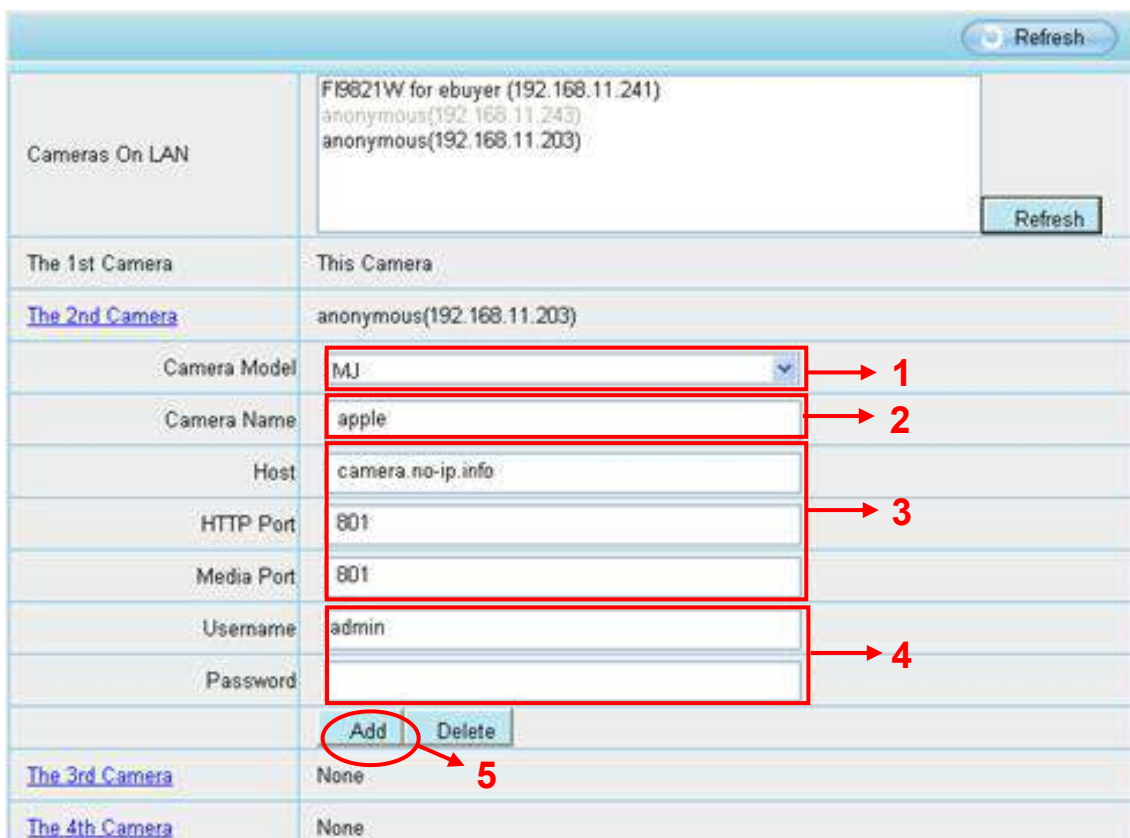

- 1----- The camera model: MJ or H.264.
- 2----- The 2nd camera's name
- 3----- Fill in the 2nd camera's DDNS host not LAN IP
- 4 ---- Enter the 2nd camera's user name and password

5---- Click Add button and to take effect

NOTE: Here the Host must be entered as the second camera's DDNS domain name, not its LAN IP.

The screenshot shows a web interface with a 'Refresh' button in the top right. Below it is a 'Device List in LAN' section containing a text box with the following entries: apple(192.168.13.102), mycamera(192.168.13.108), ipcam(192.168.13.107), and FI9821W-01(192.168.13.106). A 'Refresh' button is located at the bottom right of this list. Below the list is a table with two columns: 'Device' and 'Host'. The table contains the following rows:

The 1st Device	This Device
The 2nd Device	apple(camera.no-ip.info)
The 3rd Device	ipcam(test01.foscam.org)
The 4th Device	mycamera(owlejeww.no-ip.info)
The 5th Device	None
The 6th Device	None
The 7th Device	None
The 8th Device	None
The 9th Device	None

At the bottom of the interface, there is an attention message: 'Attention: If you want to access the device from internet, be sure the host and port that you set can be accessed from internet.'

Return to video window. You will see all of the cameras accessible through the internet.

When you are away from home, you can use the first camera's DDNS domain name and port to view all the cameras via internet.

4.3.5 Voice Prompt

On this page, you can enable or disable voice prompt. Select "Yes" to enable or select "No" to disable. If select "Yes", you can hear the voice prompt after connect the audio output device.

The screenshot shows a configuration interface with a 'Save' button and a 'Refresh' button in the top right. Below them is a 'Voice Prompt' section with a dropdown menu currently set to 'Yes'.

4.4 Network

This section will allow you to configure your camera's IP, PPOE, DDNS, Wireless Settings, UPnP, Port, Mail Settings and FTP Settings.

4.4.1 IP Configuration

If you want to set a static IP for the camera, please go to **IP Configuration** page. Keep the camera in the same

subnet of your router or computer.

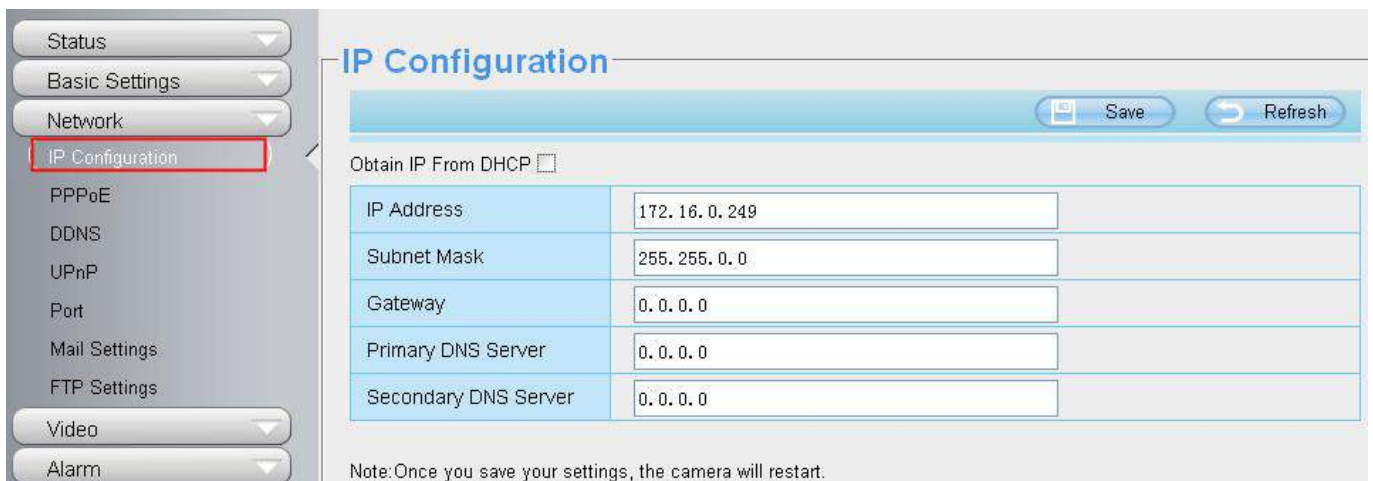

Changing settings here is the same as using the Equipment Search Tool.

It is recommended that you use the subnet mask, gateway and DNS server from your locally attached PC. If you don't know the subnet mask, gateway and DNS server, you can check your computer's local area connection as follows:

Control Panel > Network Connections > Local Area Connections > Choose Support > Details.

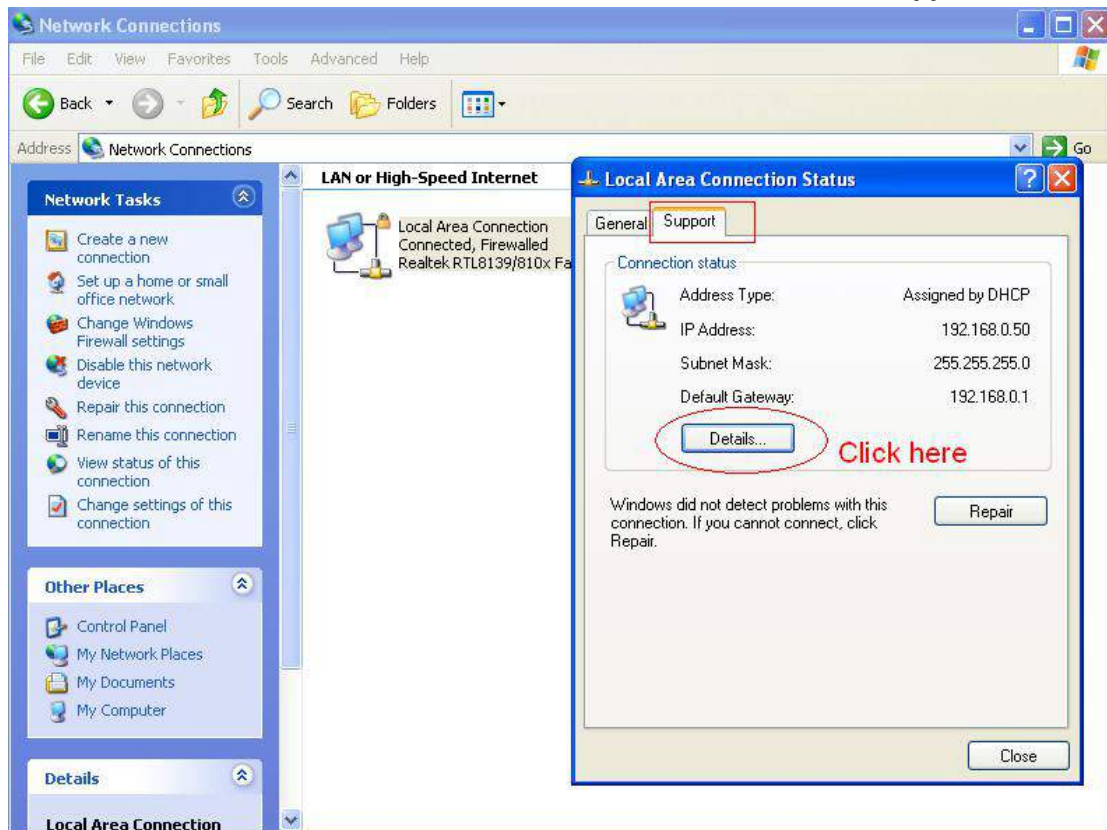

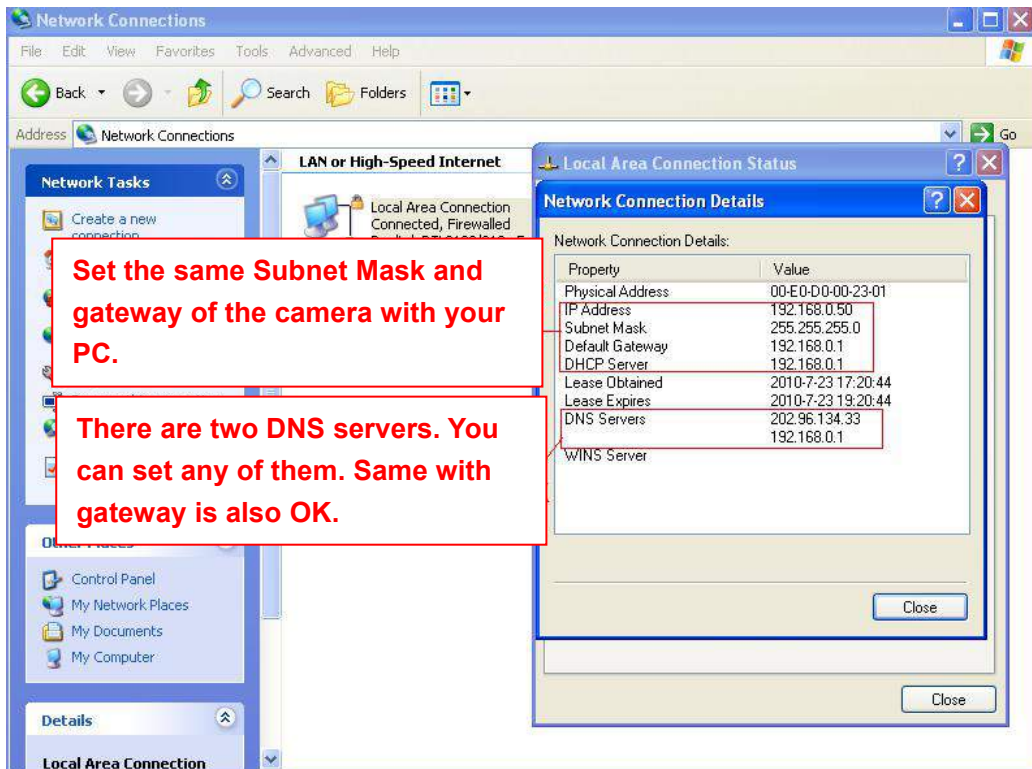

If you don't know the DNS server, you can use the same settings as the Default Gateway.

4.4.2 Wireless Settings

Step 1: Choose **Settings** on the top of the camera interface, and go to the "Network" panel on the left side of the screen, then click **Wireless Settings**.

Click the Scan button and the camera will detect all wireless networks around the area. It should also display your router in the list.



Step 2: Click the SSID (name of your router) in the list, the corresponding information related to your network, such as the name and the encryption, will be filled into the relevant fields automatically.

You will only need to fill in the password of your network. Make sure that the SSID, Encryption and the password you filled in are exactly the same for your router.

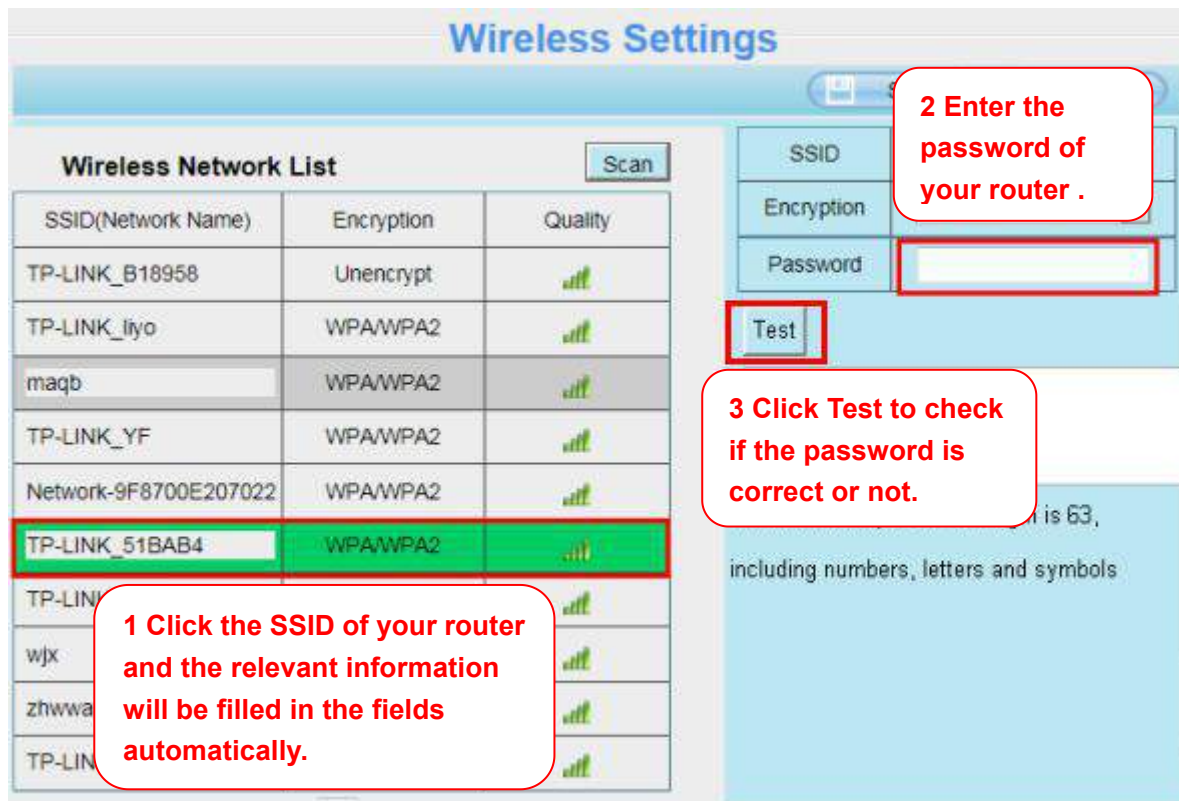

Step 3: Please click on the Save button after all settings have been entered and disconnect the network cable. Never shut down the power of the camera until the IP camera is able to connect to the wireless network.

The LAN IP address will disappear on the window of Equipment Search Tool when the camera is configuring a wireless connection. Wait about 1 minute, the camera should obtain a wireless connection, and the LAN IP of the camera will show again on the window of the Equipment Search Tool. The IP address may have changed after the camera receives a wireless connection; we recommend setting a static local IP address if this IP address changes by right clicking the camera in Equipment Search Tool, setting a static IP, and pushing OK. Congratulations! You have set up the wireless connection of the camera successfully.

NOTE: If you fail to make a wireless connection, please refer to your seller or contact us directly for assistance.

4.4.3 PPPoE

Only some models support PPPoE.

If you are using a PPPoE connection, enable it and enter the User Name and Password for your PPPoE account.

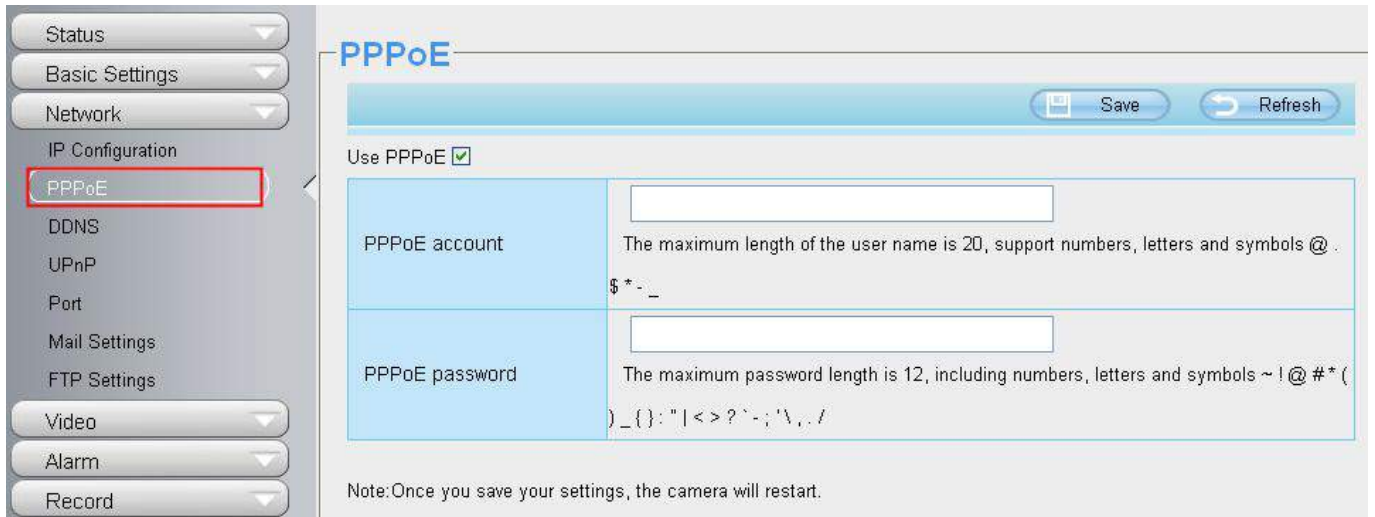

4.4.4 DDNS

If you need DDNS, you can apply it on DDNS page.

First Enable DDNS, then select from DDNS Server list, click "Get My DDNS Now".

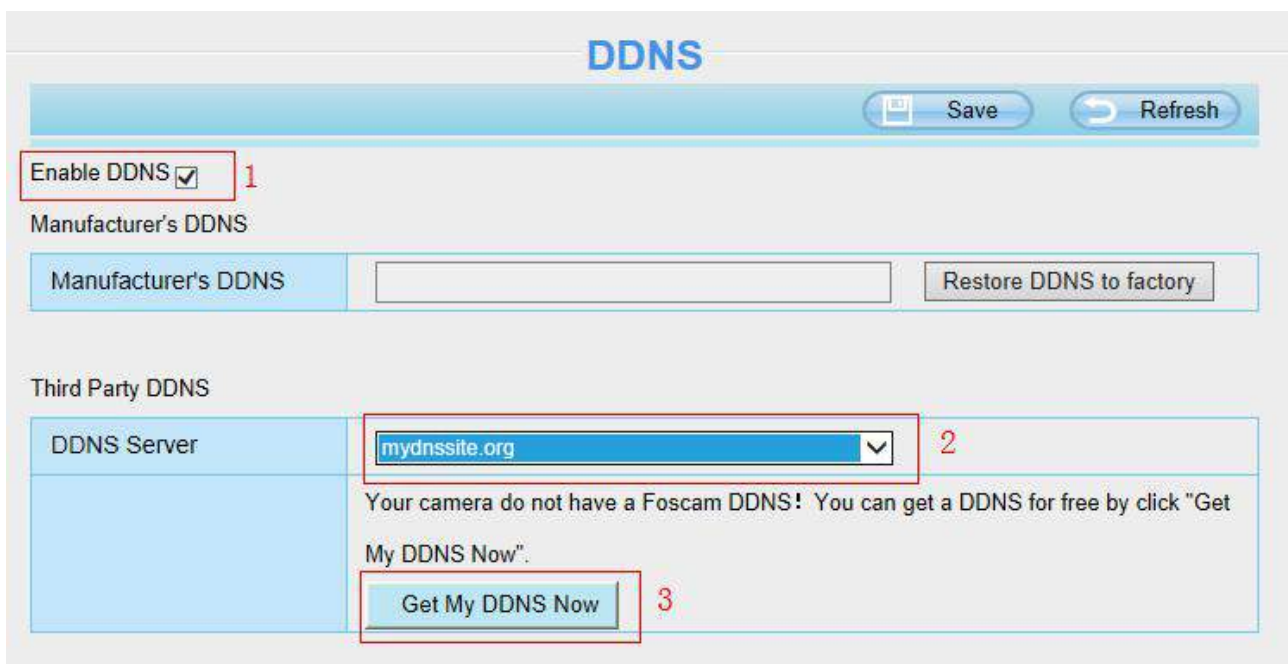

DDNS



Save



Refresh

Please login your Foscam Cloud Account for myfoscam.org.

E-mail

Password

Get DDNS

I don't have a Foscam Account! [Tap HERE](#)

DDNS



Save



Refresh



Please register your Foscam Cloud Account and get myfoscam.org.

E-mail

Password

Confirm Password

Get DDNS

After get DDNS, click “Finish” to go back to DDNS settings.

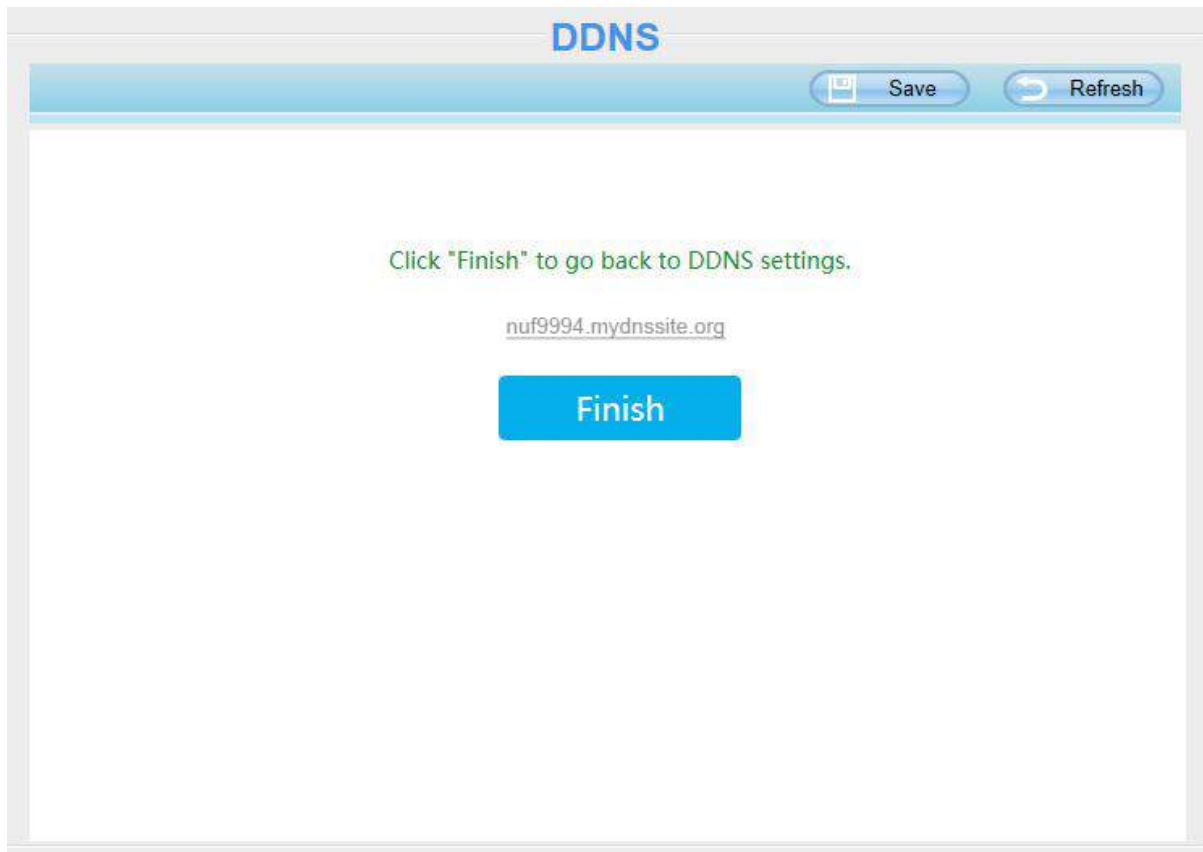

If the network error, you fail to get the DDNS, please try again.

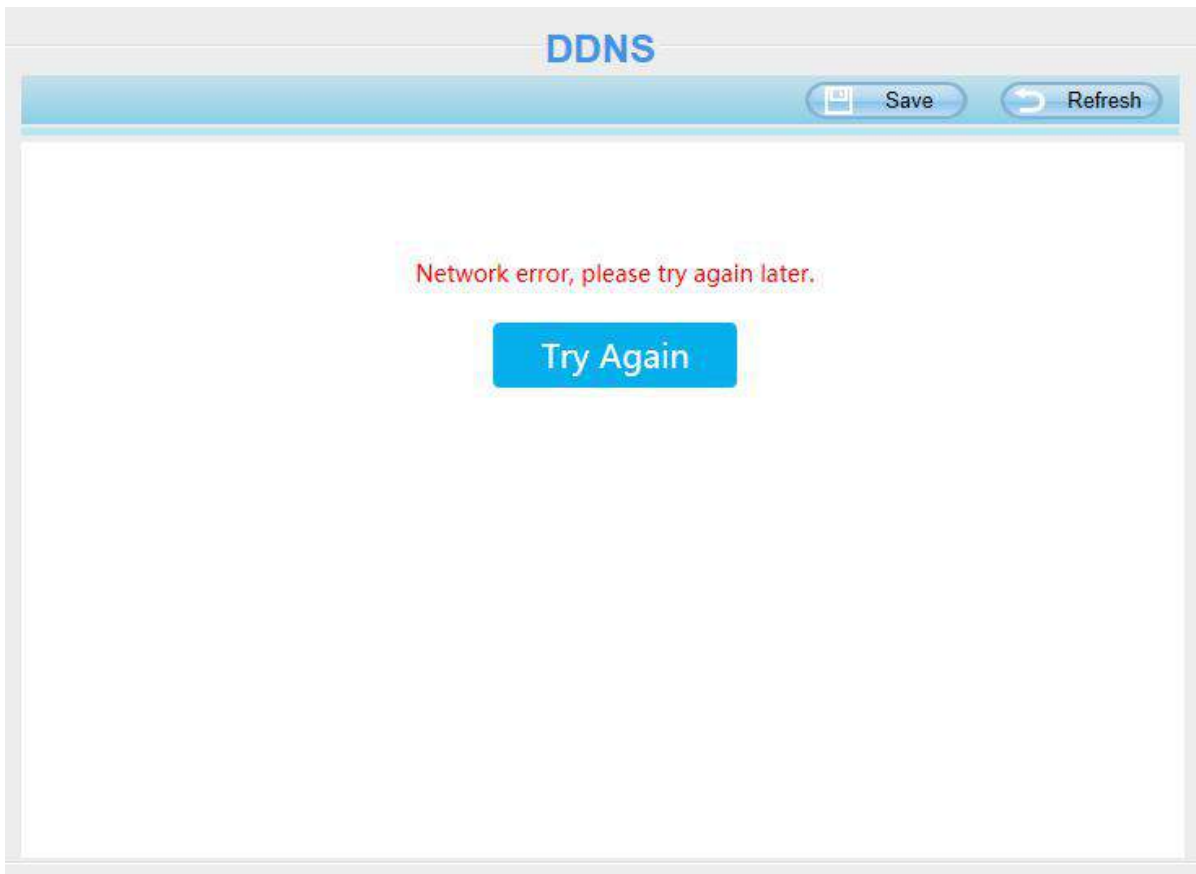

Once you success get DDNS, you can follow below step to use.

Here take **test09.mydnssite.org** for example. Go to option of DDNS on the **Settings->Network** panel, you can see the domain name.

Here take **cp4911.mydnssite.org** for example. Go to option of DDNS on the **Settings->Network** panel, you can see the domain name.

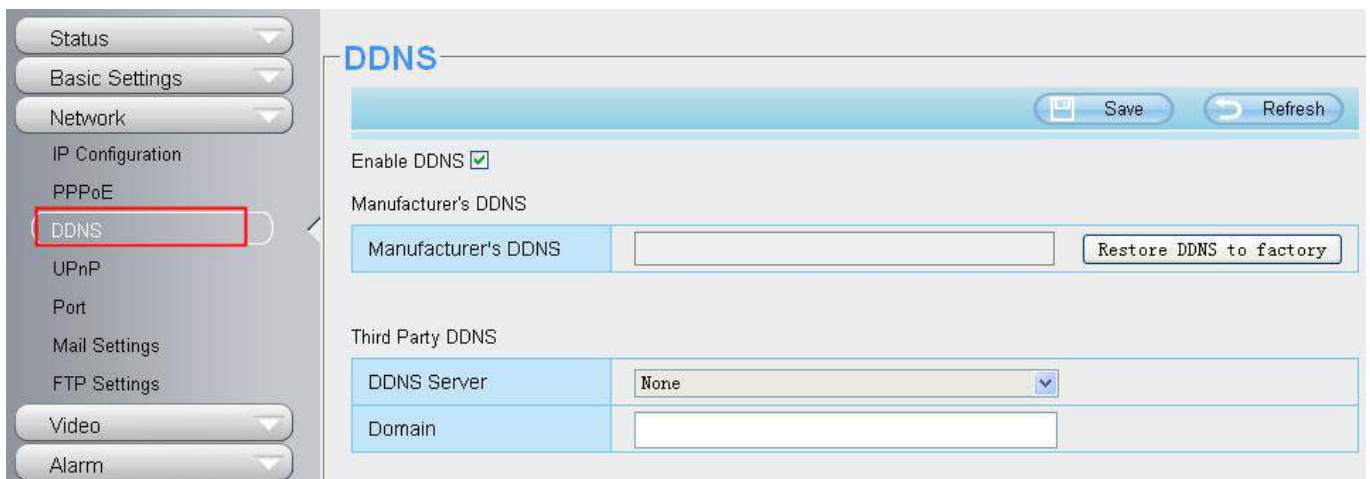

Now you can use **http:// Domain name + HTTP Port** to access the camera via internet.

Take hostname **cp4911.mydnssite.org** and HTTP Port no. 8000 for example, the accessing link of the camera via internet would be **http://cp4911.mydnssite.org:8000**

Restore DDNS to factory: If you have configured Third Party DDNS successfully, but you want to use

Manufacturer's DDNS again , here click this button and start Manufacturer's DDNS Service.

Third Party Domain Name Settings

User can also use third part DDNS, such as www.no-ip.com , www.3322.com

Here take www.no-ip.com for example:

1. Step 1 Go to the website www.no-ip.com to create a free hostname

Firstly: Login on www.no-ip.com and click No-IP Free to register.



Please register an account step by step according to instructions on www.no-ip.com

After registration, please login your email which used to register. You will receive an email from website, please click the link to activate your ACCOUNT as indicated in email.

Secondly: Login the link with the registered username and password to create your domain name.

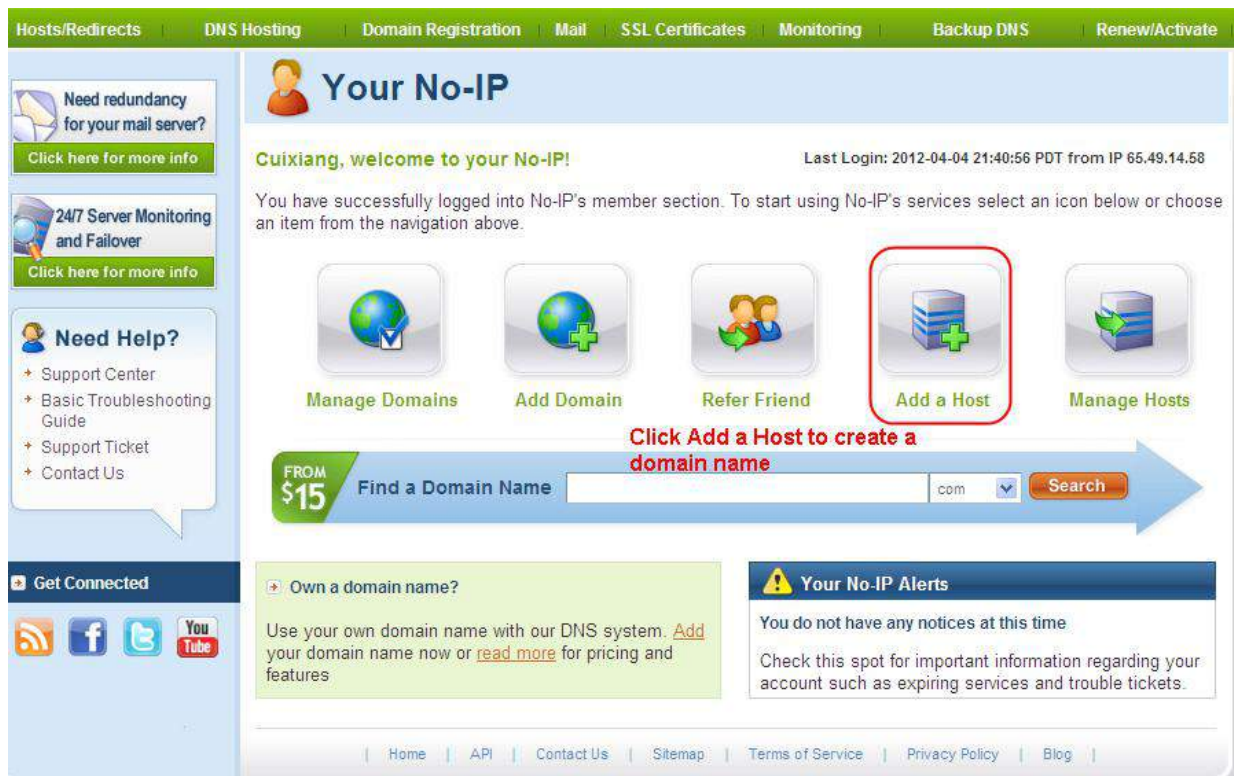
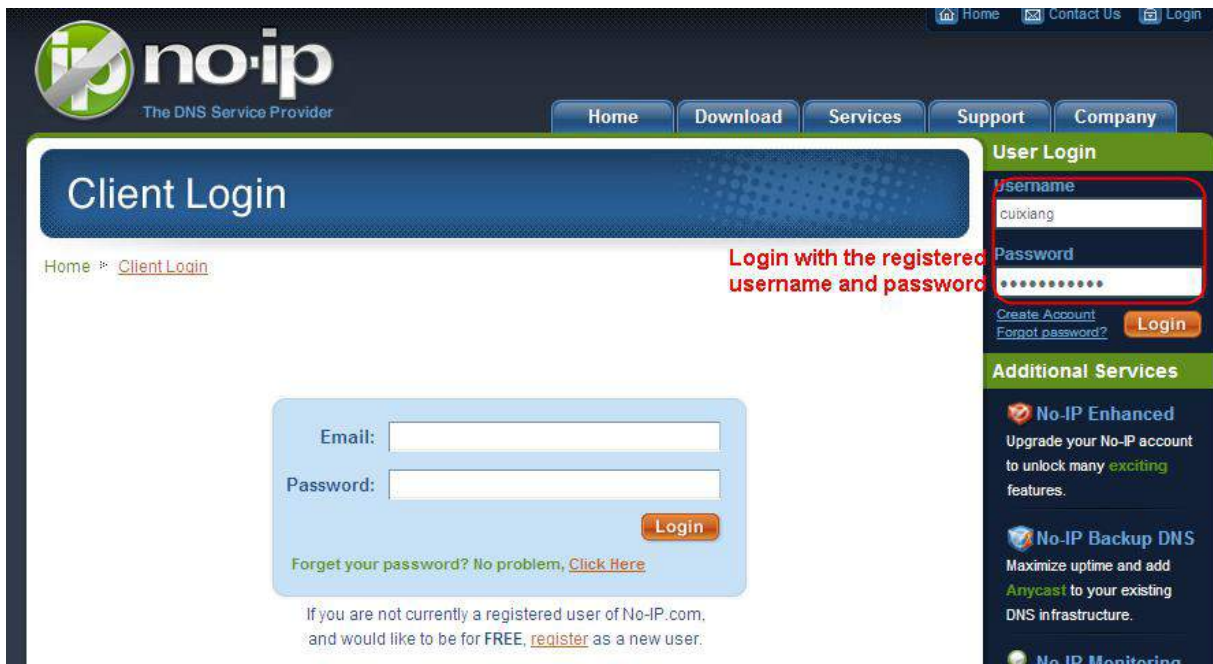

Please create the domain name step by step according to instructions on www.no-ip.com

Step 2 DO DDNS Service Settings within the Camera

Please set DDNS Settings within the camera by hostname, a user name and password you've got from www.no-ip.com

Take hostname `ycxgwp.no-ip.info`, user name **larson**, password **larson2012** for example.

Firstly, goes to option of DDNS Settings on the administrator panel.

Secondly, select No-IP as a server.

Thirdly, fill larsen as DDNS user, fill password larsen2012 as DDNS password, fill ycxgwp.no-ip.info as DDNS domain and server URL, Then click save to make effect. The camera will restart and to take the DDNS settings effective.

Fourthly, after the restart, login the camera, and go to option of Device Status on the administrator panel, and check if the DDNS status is successful.

If failed, please double check if you have input the correct hostname, user name, and password, and try to redo the settings.

NOTE: If you have set Third Party DDNS successfully ,the Domain Name will be invalid. The Third Party DDNS and the Domain Name cannot work at the same time, the last time you configured will take effect.

2. Do port forwarding within the router

Example: The camera's LAN IP address is http://192.168.8.100:2000

Firstly, login the router, goes to the menu of Port Forwarding or Port Trigger (or named Virtue Server on some brands of router). Take Linksys brand router as an example, Login the router, and goes to Applications & Gaming > Single Port Forwarding.

Secondly, Create a new column by LAN IP address & HTTP Port No. of the camera within the router showed as below.

The screenshot shows the 'Single Port Forwarding' configuration page on a Linksys router. The table below is a representation of the data shown in the image:

Application Name	External Port	Internal Port	Protocol	To IP Address	Enabled
None	---	---	---	192.168.8.	<input type="checkbox"/>
None	---	---	---	192.168.8.	<input type="checkbox"/>
None	---	---	---	192.168.8.	<input type="checkbox"/>
None	---	---	---	192.168.8.	<input type="checkbox"/>
Http	2000	2000	Both	192.168.8.100	<input checked="" type="checkbox"/>
Media	9200	9200	Both	192.168.8.100	<input checked="" type="checkbox"/>
				192.168.8.	<input type="checkbox"/>

Callout boxes in the image provide the following instructions:

- Assign a name as you like here .** (points to the Application Name dropdown)
- Fill the HTTP Port no. of the camera on the column of External Port and Internal Port.** (points to the External and Internal Port fields for the 'Http' row)
- Fill the Media Port no. of the camera on the column of External Port and Internal Port .** (points to the External and Internal Port fields for the 'Media' row)
- Fill the LAN IP of the camera here, just input the last section.** (points to the To IP Address field for the 'Http' row)

3. Use domain name to access the camera via internet

After the port forwarding is finished, you can use the **domain name+ http no.** to access the camera via internet. Take hostname ycxgwp.no-ip.info and http no. 2000for example, the accessing link of the camera via internet would be `http:// ycxgwp.no-ip.info:2000`

4.4.5 UPnP

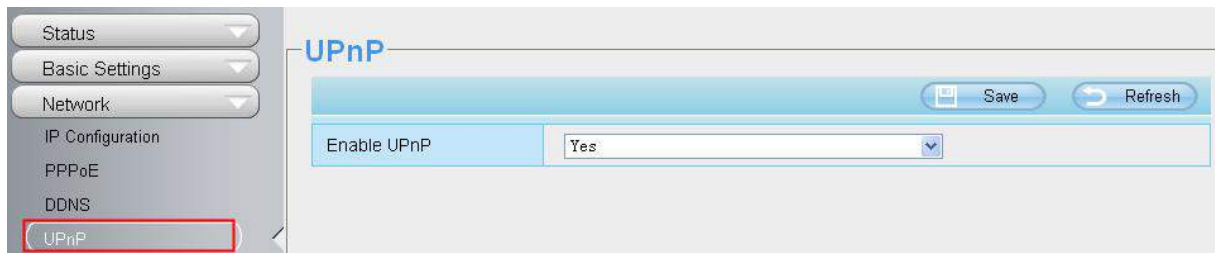

The default UPnP status is closed. You can enable UPnP, then the camera's software will be configured for port forwarding. Back to the **Device Status** panel, you can see the UPnP status:



The camera's software will be configured for port forwarding. There may be issues with your routers security settings, and sometimes may error. We recommend you configure port forwarding manually on your router .

4.4.6 Port

This camera supports HTTP Port / HTTPS Port / ONVIF Port. HTTP Port is used to access the camera remotely.

HTTP port: By default, the HTTP is set to 88. Also, they can be assigned with another port number between 1 and 65535. But make sure they can not be conflict with other existing ports like 25, 21.

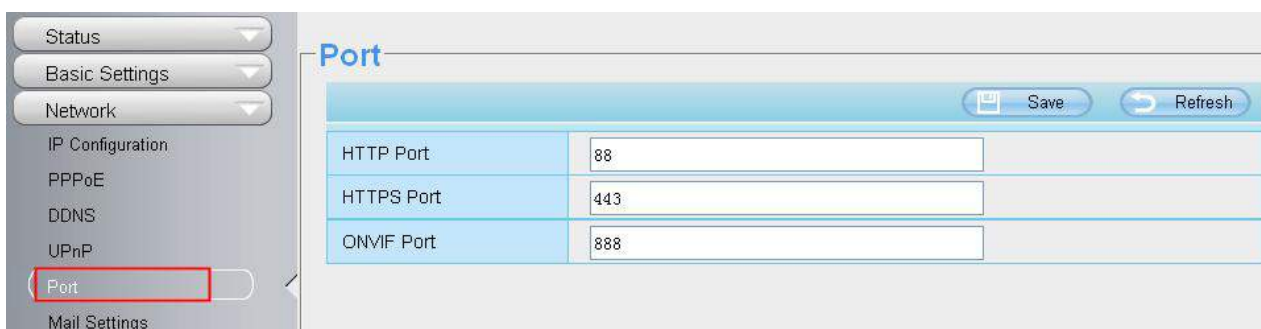

Another way to change the HTTP port no.

Step 1: Open the Equipment Search Tool, select the camera you would like to change the port of, right click on the IP address, and click on "Network Configuration", this brings up the network configuration box .

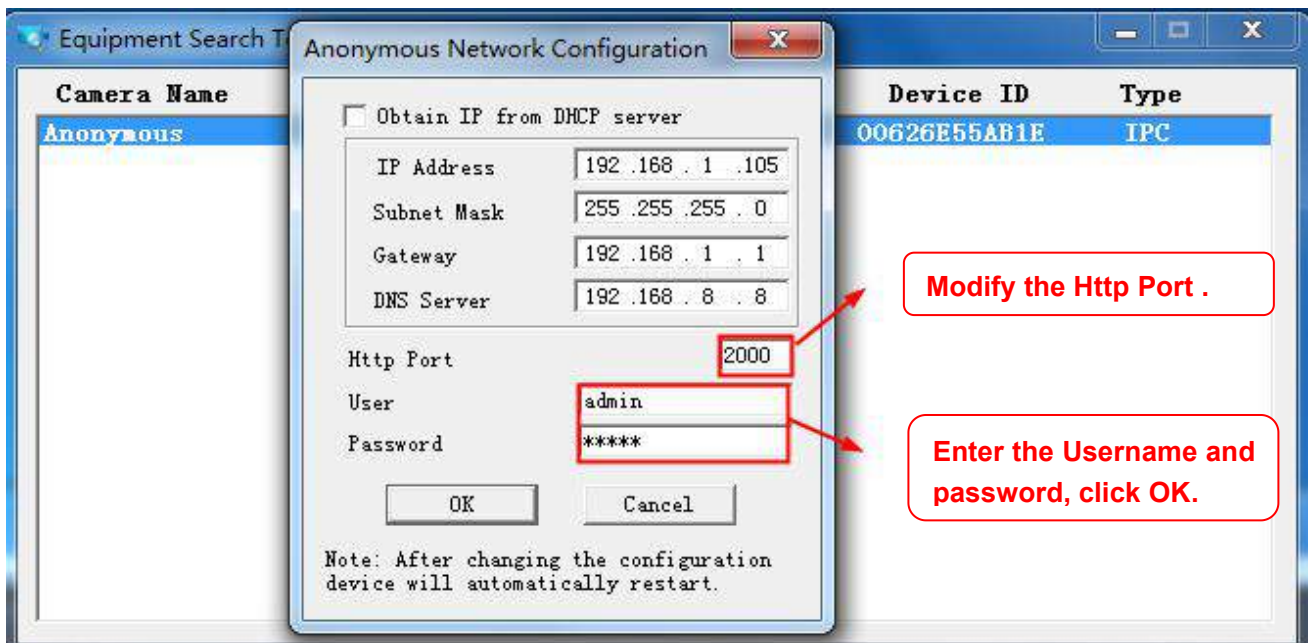
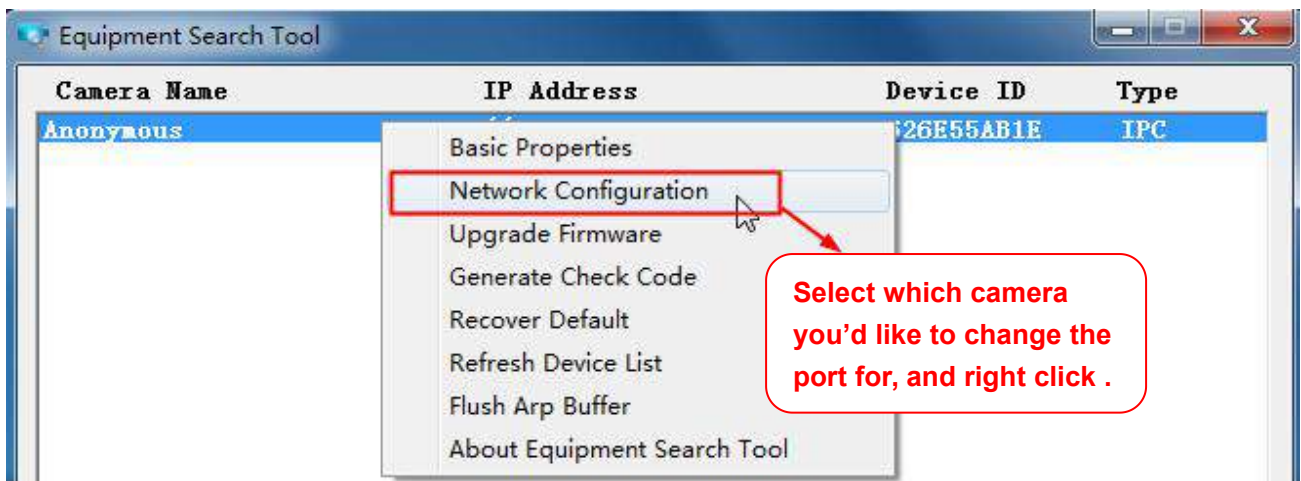

Step 2: Enter the username and password of the Administrator (default username is admin with a blank password), and click **OK** to apply changes.

Step 3: Wait around 10 seconds, you'll see that the camera's LAN IP address has changed. In our example it was changed to 2000, so we see http://192.168.1.105:2000 in Equipment Search Tool. Also, the LAN IP address is now fixed at a static IP address of http://192.168.1.105:2000. This IP address will not change even if the camera is powered off and back on, the camera will remain on this LAN IP address. This is very important that a static LAN IP address is set, or you may have problems later with remote access and seeing the camera remotely if the camera loses power and reconnects on a different LAN IP address. Make sure you set a static LAN IP address!



Figure 4.1

NOTE: If the camera cannot be accessed, please make sure the port forwarding is succeed.

HTTPS Port: The default port is 443. You can use the url to access the camera: https:// IP + HTTPS port.

ONVIF Port: By default, the ONVIF port is set to 888. Also, they can be assigned with another port number between 1 and 65535 (except 0 and 65534). But make sure they can not be conflict with other existing ports.

RTSP Port: The default port is 554,only some IP Cameras have RTSP port.

4.4.7 Mail Settings

If you want the camera to send emails when motion has been detected, here Mail will need to be configured.

Enable	<input checked="" type="checkbox"/>
SMTP Server	smtp.gmail.com
SMTP Port	25
Transport Layer Security	STARTTLS <small>G-Mail only supports TLS at Port 465 and STARTTLS at Port 587 or 25.</small>
Need Authentication	Yes
SMTP Username	cuiyao93@gmail.com
SMTP Password Test
Sender E-mail	cuiyao93@gmail.com
First Receiver	yaoyao@163.com
Second Receiver	
Third Receiver	
Fourth Receiver	

1----- SMTP Server / Port / Transport Layer Security Enter SMTP server for sender. SMTP port is usually set as 25. Some SMTP servers have their own port, such as 587 or 465, and Transport Layer Security usually is None. If you use Gmail, Transport Layer Security must be set to TLS or STARTTLS and SMTP Port must be set to 465 or 25 or 587, which port you choose should be decided by which Transport Layer Security you select.

2-----SMTP Username / password ID account and password of the sender email address

3----- Sender E-mail Mailbox for sender must support SMTP

4----- Receiver Mailbox for receiver need not support SMTP, you can set 4 receivers

5----- Save Click Save to take effect

6----- Test Click Test to see if Mail has been successfully configured.

Click **Test** to see if Mail has been successfully configured.

Save Refresh	
Enable <input checked="" type="checkbox"/>	
SMTP Server	smtp.gmail.com
SMTP Port	25
Transport Layer Security	STARTTLS G-Mail only supports TLS at Port 465 and STARTTLS at Port 587 or 25.
Need Authentication	No
SMTP Username	yaoyao@gmail.com
SMTP Password Test Success
Sender E-mail	yaoyao@gmail.com
First Receiver	yaoyao@163.com
Second Receiver	
Third Receiver	
Fourth Receiver	

Test result .

If the test success, you can see the Success behind the Test, at the same time the receivers will receive a test mail.

If the test fails with one of the following errors after clicking Test, verify that the information you entered is correct and again select Test .

- 1) Cannot connect to the server.
- 2) Network Error. Please try later.
- 3) Server Error.
- 4) Incorrect user or password.
- 5) The sender is denied by the server. Maybe the server need to authenticate the user, please check it and try again.
- 6) The receiver is denied by the server. Maybe because of the anti-spam privacy of the server.
- 7) The message is denied by the server. Maybe because of the anti-spam privacy of the server.
- 8) The server does not support the authentication mode used by the device.

4.4.8 FTP Settings

If you want to upload record images to your FTP server, you can set **FTP Settings**.

Save Refresh	
FTP Server	<input type="text" value="ftp://192.1681.8.150"/> Example:ftp://192.168.1.103/dir The maximum length of the address is 127, does not support the character & =
Port	<input type="text" value="21"/>
FTP Mode	PASV
Username	<input type="text" value="user"/> The maximum length of the user name is 63, support numbers, letters and symbols _ @ \$ * - , . # !
Password	<input type="password" value="....."/> The maximum password length is 63, including numbers, letters and symbols ~ ! @ # \$ % ^ * () _ + { } : " < > ? ` - ; ' \ , . /
Test	FTP server address error

FTP server: If your FTP server is located on the LAN, you can set as Figure as above. If you have an FTP server which you can access on the internet, you can set as below.

Save Refresh	
FTP Server	<input type="text" value="ftp://ftp.mgenseal.com"/> Example:ftp://192.168.1.103/dir The maximum length of the address is 127, does not support the character & =
Port	<input type="text" value="21"/>
FTP Mode	PASV
Username	<input type="text" value="user"/> The maximum length of the user name is 63, support numbers, letters and symbols _ @ \$ * - , . # !
Password	<input type="password" value="....."/> The maximum password length is 63, including numbers, letters and symbols ~ ! @ # \$ % ^ * () _ + { } : " < > ? ` - ; ' \ , . /
Test	Success

Port: Default is port 21. If changed, external FTP client program must change the server connection port accordingly.

FTP Mode: Here supports two modes: PORT and PASV.

Username / password: The FTP account and password.

Click Save to take effect.

Click Test to see if FTP has been successfully configured.

4.4.9 P2P (Except FI9804W / FI9805W / FI9805E)

Access the camera by smart phone (Android or iOS operating system), please refer to the Quick Setup Guide. First of all, you need to open the P2P function of the camera at **Settings > Network > P2P**.

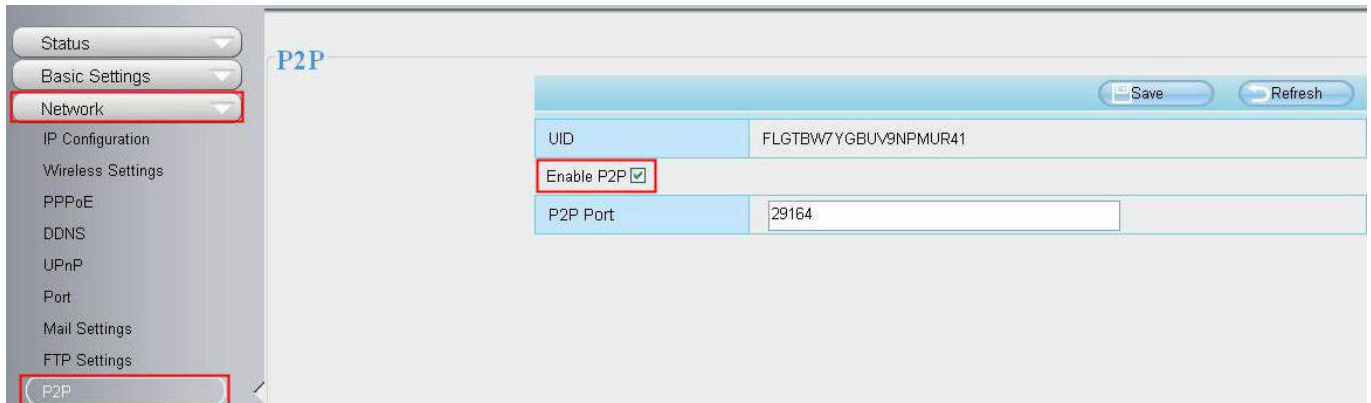

4.5 Video

This section allows you to configure Video stream settings, On screen display and Snapshot settings.

4.5.1 Video Settings

There are two ways to set the stream video settings. They are main stream video settings and sub stream video settings.

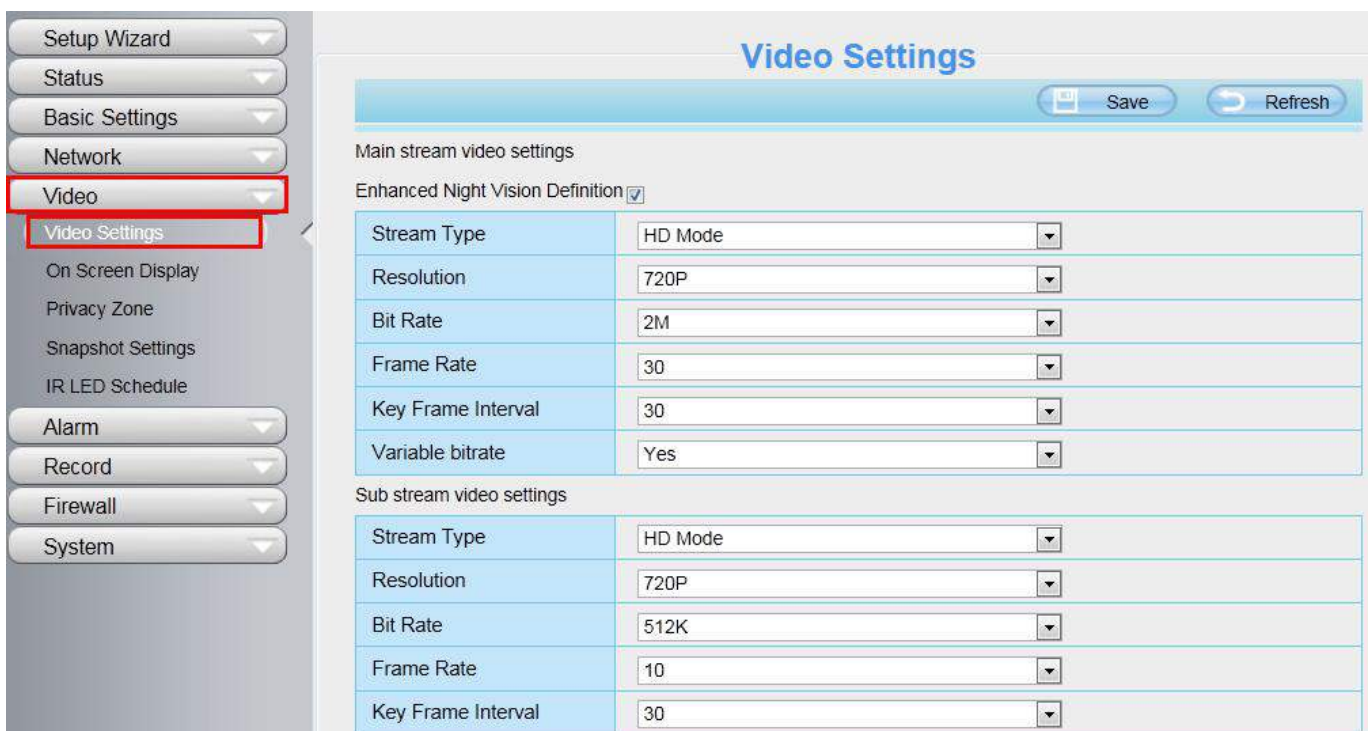

Enhanced Night video Definition: The camera will automatically drop the frame to extend the recording time in the night.

Stream Type: There are four types to identify different streams you have set. If select the HD Mode, the clearer video will become, and it will take up more bandwidth; If select the Smooth Mode, the bandwidth is very narrow, and bit rate is large, that will lead to video can not play well. The Equilibrium Model is a value between HD Mode and Smooth Mode.

Resolution: The camera supports multiple types, For example: 1080P, 960P, 720P, VGA. The higher the resolution is, the clearer video will become. But the code flux will become larger too, and it will take up more bandwidth. (Different models support different specific types.)

Bit Rate: Generally speaking, the larger the bit rate is, the clearer video will become. But the bit rate configuration should combine well with the network bandwidth. When the bandwidth is very narrow, and bit rate is large, that will lead to video can not play well.

Frame Rate: Note that a larger frame size takes up more bandwidth. You should lower frame rate when the bandwidth is limited. Normally, when the frame rate above 15, you can achieve fluently video. The maximum frame rate for each model is different, please see the [6.3 Specification](#).

Key Frame Interval: The time between last key frame and next key frame. The shorter the duration, the more likely you will get a better video quality, but at the cost of higher network bandwidth consumption.

Rate Control Mode: There are three rate control modes.

CBR: Constant Bit Rate, it means that the Bit Rate is constant.

VBR: Variable Bit Rate, the camera will change the video bit rate according to the situation, but will not more than the maximum parameter "Bit Rate".

LBR: Low Bit Rate. If you can select the LBR, then you can slide the scroll bar to choose percentage of the bit rate. By reducing the bit rate, so that the camera can obtain a better image at low bandwidth.

4.5.2 On Screen Display

This page is used to add timestamp and device name on the video.

OSD	
Display Timestamp	Yes
Display Camera Name	Yes

Display Timestamp: There are two options: Yes or NO. Select Yes and you can see the system date on the video.

Display Camera Name: There are two options: Yes or NO. Select Yes and you can see the device name on the video.

4.5.3 Privacy Zone

This page is used to add privacy zone on the video.

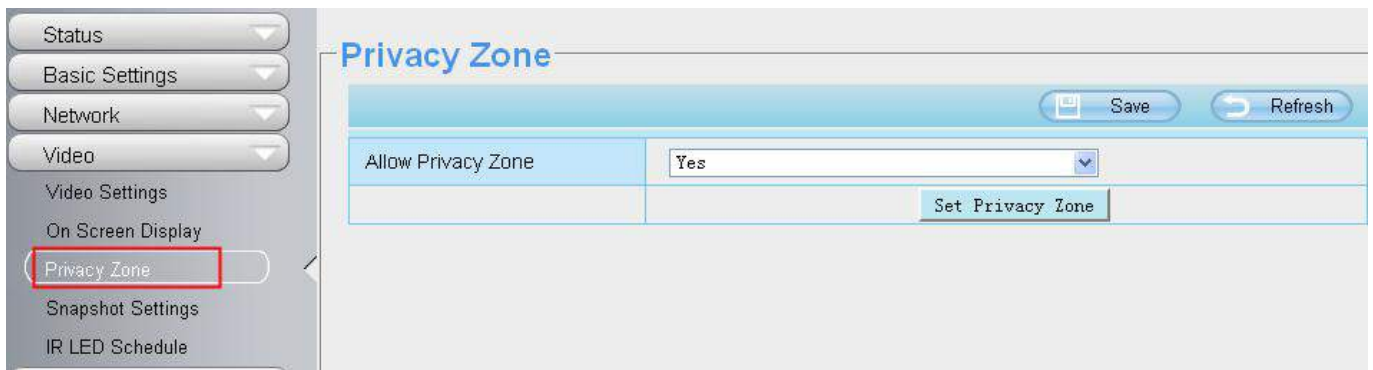

Allow On Screen Display Mask

There are two options: Yes or NO. Select yes and draw a mask area on the video, the mask area will be black on the video.



Click **OK** button and return to the **Privacy Zone** page, click Save to take effect. Back to the surveillance window, you can see the privacy area as the following picture:



4.5.4 Snapshot Settings

In this page you can set the snapshot pictures' image quality and the storage path.

Snapshot Settings

Manual snap Quality	Medium
Pictures Save To	FTP

Enable timing to capture

Capture interval	2 (1-65535s)
------------------	--------------

Enable set Filename

Filename	NAME
----------	------

All	00	01	02	03	04	05	06	07	08	09	10	11	12	13	14	15	16	17	18	19	20	21	22	23
MON																								
TUE																								
WED																								
THU																								
FRI																								
SAT																								
SUN																								

Manual snap Quality: Low, Middle and High. The higher the quality, the picture will be clearer.

Pictures Save To: FTP or SD card. If you have done FTP and Alarm settings, when alarming, the camera will snap pictures to the FTP or SD card automatically.

If you select the FTP, you can set the file name which the picture save to. For example: file name is "NAME", the snapshot picture is "NAME_20150605-180000.jpg".

Enable timing to capture

To enable capture interval, follow the steps below:

1 Select **Enable timing to capture**

2 Capture interval: The interval time between two captures.

3 Select the capture time

- Capture anytime

Click the black button up the MON, you will see all time range turn red. When something moving in the detection area at anytime, the camera will capture.

- Specify an capture schedule

Click the week day words, the corresponding column will be selected. For example, click TUE, the all column of TUE turns to red, that means during Tuesday whole day, the camera will capture.

- Press the left mouse and drag it on the time boxes, you can select the serial area,

4 Click Save button to take effect.

4.5.5 IR LED Schedule

On this page you can set the schedule time for switching IR LED lights. When parameter Mode is set to the **Schedule** on the Live **Video** window, At these schedule time, the IR LED lights will be turned off.

IR LED Schedule	
Turn the IR LED off	From 00 · 00 00 · 00 Add

4.6 Detector

4.6.1 Motion Detection

IP Camera supports **Motion Detection Alarm**, when the motion has been detected, it will send emails or upload images to FTP.

To enable motion detection, follow the steps below:

1 Enable Motion detection

2 Sensitivity---- It supports three modes: Low, Middle and High. The higher the sensitivity, the camera will be more easily alarmed. Select one motion sensitivity.

3 Trigger interval--- The interval time between two motion detections. Here supports 5s / 6s / 7s / 8s / 9s / 10s / 11s / 12s / 13s / 14s / 15s. Select one interval time.

4 There are some alarm indicators:

A Camera Sound and PC Sound

If the camera has connected with a speaker or other audio output device, if you select Camera Sound or PC Sound, when the motion has been detected, the people around the camera will hear beep alarm sound.

B Send E-mail

If you want to receive alarm emails when motion is detected, you must select Send E-mail and set Mail Settings first.

C Take Snapshot

If you select this checkbox, when the motion has been detected, the camera will snap the live view window as a still picture and load it to the FTP. Make sure you have set FTP and set FTP as the storage path in Video > Snapshot settings panel.

Time interval: The interval time between two pictures.

D Recording

If you select this checkbox, when the motion has been detected, the camera will recording and load it to the FTP server. Make sure you have set FTP and set FTP as the storage path in Video->Snapshot settings panel.

E Push message to the phone

If you select this checkbox, when the motion has been detected, the camera will push the message to the phone which has been connected the camera.

5 Set detect area

Click set detect area and it pop up a window, then you can draw the detection area. Click Back button after settings. When something moving in the detection area, the camera will alarm.

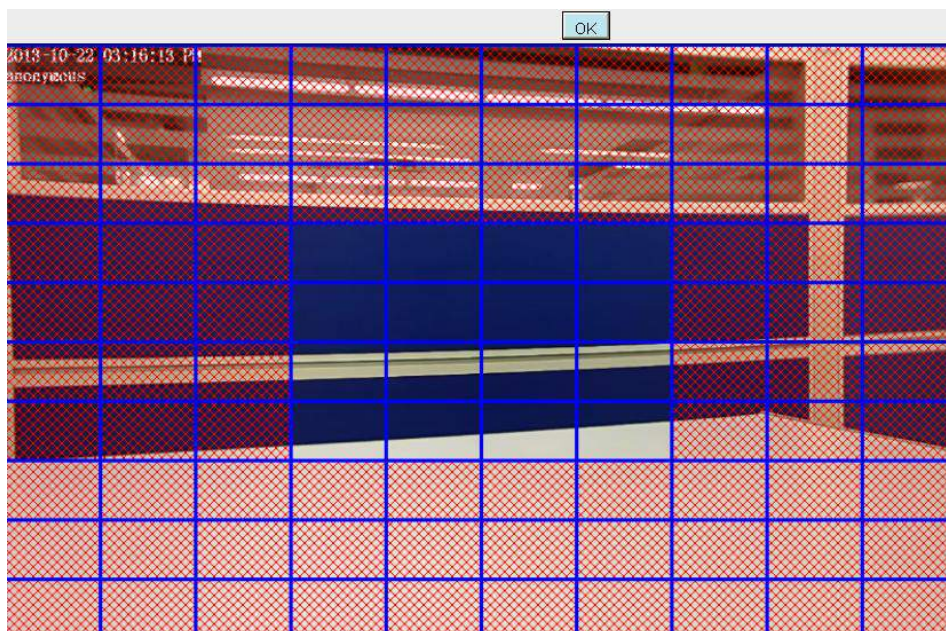

6 Alarm Schedule

A Alarm anytime when motion is detected

Click the black button up the MON, you will see all time range turn red. When something moving in the detection area at anytime, the camera will alarm.

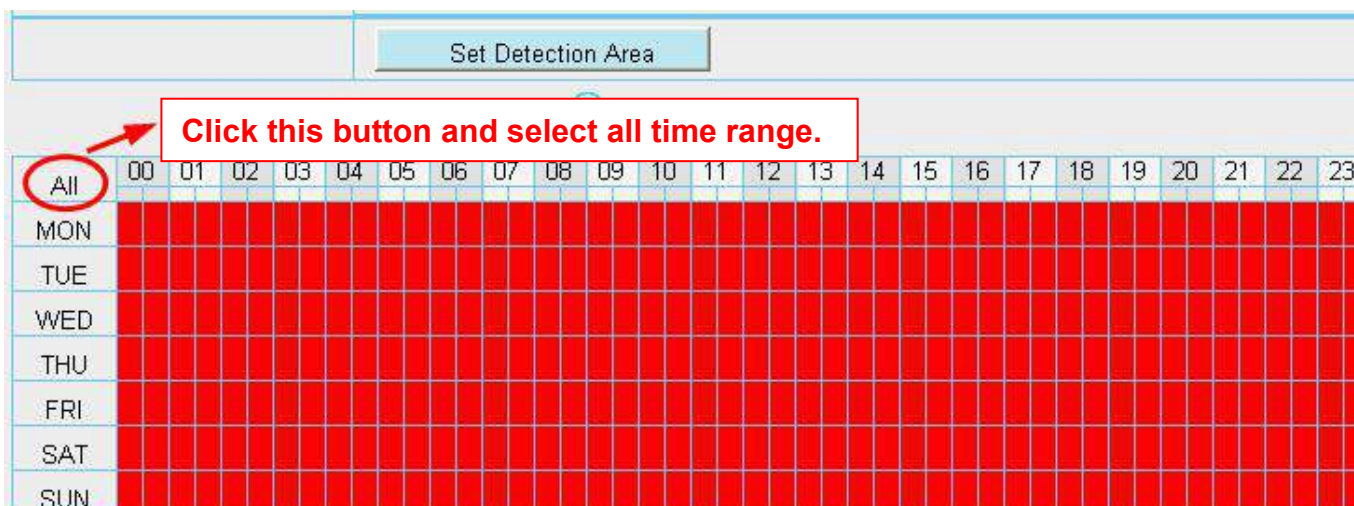

B Specify an alarm schedule

Click the week day words, the corresponding column will be selected. For example, click TUE, the all column of TUE turns to red, that means during Tuesday whole day, when something moving in the detection area, the camera will alarm.

Schedule		00	01	02	03	04	05	06	07	08	09	10	11	12	13	14	15	16	17	18	19	20	21	22	23
All																									
MON																									
TUE																									
WED																									
THU																									
FRI																									
SAT																									
SUN																									

C Press the left mouse and drag it on the time boxes, you can select the serial area,

Set Detection Area

Schedule

All	00	01	02	03	04	05	06	07	08	09	10	11	12	13	14	15	16	17	18	19	20	21	22	23
MON																								
TUE																								
WED																								
THU																								
FRI																								
SAT																								
SUN																								

When the PC sound alarm is enabled, the PC will make a sound only in Live Video page while the IPC detected an alarm

7 Click **Save** button to take effect. When the motion is detected during the detection time in the detection area, the camera will alarm and adopt the corresponding alarm indicators.

NOTE: You must set the detection area and detection schedule, or else there is no alarm anywhere and anytime.

4.6.2 Sound Detection

FI9800P do not support Sound alarm.

When the ambient sound over a certain decibel ,the sound alarm will be triggered.

Sound Detection

Enable

Sensitivity	Low
Triggered Interval	15s
Action	Camera Sound <input type="checkbox"/> PC Sound <input type="checkbox"/>
	Send E-mail <input checked="" type="checkbox"/>
	Take Snapshot <input checked="" type="checkbox"/> Time Interval 2s
	Please set the capture storage location in advance.(Video -> Snapshot Settings)
	Recording <input checked="" type="checkbox"/> Please set the video storage location in advance.(Record -> Storage Location)
Push message to the phone <input checked="" type="checkbox"/>	

	00	01	02	03	04	05	06	07	08	09	10	11	12	13	14	15	16	17	18	19	20	21	22	23
All																								
MON																								
TUE																								

- If the Sensitivity is set to **High**, the camera will detect the sound whose more than 55db.
- If the Sensitivity is set to **Medium**, the camera will detect the sound whose more than 65db.
- If the Sensitivity is set to **Low**, the camera will detect the sound whose more than 75db.
- If the Sensitivity is set to **Lower**, the camera will detect the sound whose more than 85db.
- If the Sensitivity is set to **Lowest**, the camera will detect the sound whose more than 95db.

4.6.3 IO Alarm (only FI9805E)

This IP camera provides a IO alarm terminal block which is used to connect to external input / output device. The alarm device (door sensor, infrared sensor, smoke detectors, etc) send input command to the network camera, then the network camera send output command to the alarm output device (local audible alarm, lights alarm,etc).

IO

Enable

Trigger level	Low
Triggered Interval	5s
Action	<input type="checkbox"/> Camera Sound <input type="checkbox"/> PC Sound
	<input type="checkbox"/> Send E-mail
	<input type="checkbox"/> Take Snapshot Time Interval <input type="text" value="2s"/>
	Please set the capture storage location in advance.(Video -> Snapshot Settings)
	<input type="checkbox"/> Recording Please set the video storage location in advance.(Record -> Storage Location)
	<input type="checkbox"/> IO Output <input type="button" value="Clear IO Alarm Output"/>

All	00	01	02	03	04	05	06	07	08	09	10	11	12	13	14	15	16	17	18	19	20	21	22	23
MON																								
TUE																								

There is an IO alarm input / output lines in the camera tails. Enable IO alarm need this cable to connect to the alarm device (door sensor, infrared sensor, smoke detector, etc.).

I/O Alarm has four ports:

- Port 1 and port 2 indicate IO alarm input
- Port 3 and port 4 indicate IO alarm output



Setting IO alarm

On the IO page, Enable the I/O alarm, select the **Send E-mail** and **Snapshot** before you have configured the mail and FTP.

If an IO alarm is triggered and IO alarm output device will always alarm (sound alarm is issued a warning sound, alarm lights in flash etc). Click **Clear IO alarm output** , the alarm output device will stop alarming. If IO alarm is triggered again after alarm interval, IO alarm output device will be restart.

NOTE: Motion detection alarm can also be triggered IO alarm output.

4.7 Record

4.7.1 Storage Location

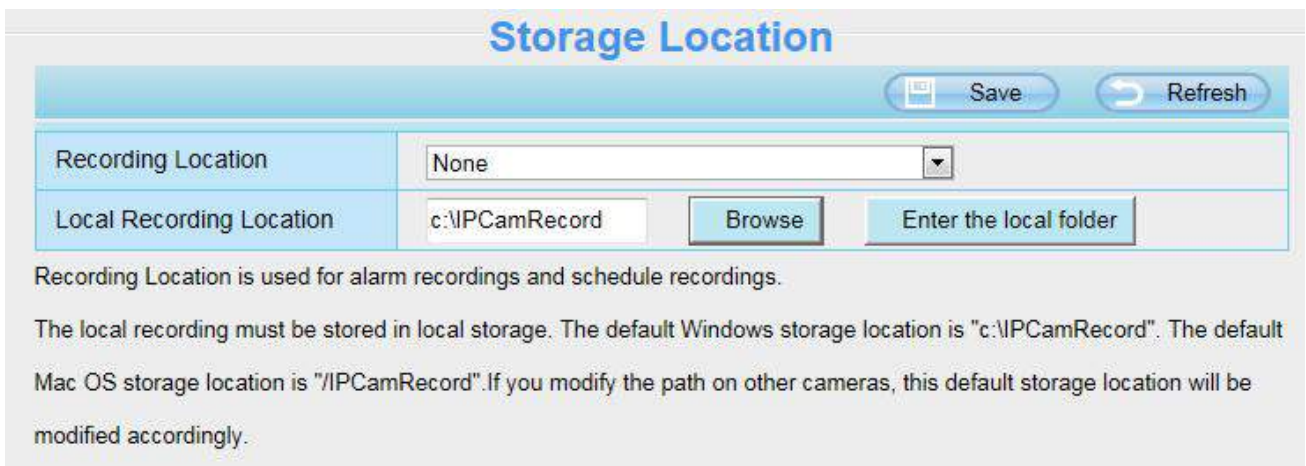

Storage Location

Save Refresh

Recording Location	None
Local Recording Location	c:\IPCamRecord <input type="button" value="Browse"/> <input type="button" value="Enter the local folder"/>

Recording Location is used for alarm recordings and schedule recordings.

The local recording must be stored in local storage. The default Windows storage location is "c:\IPCamRecord". The default Mac OS storage location is "/IPCamRecord". If you modify the path on other cameras, this default storage location will be modified accordingly.

Recording Location: SD card, FTP.

- SD card: The video will be saved in SD card. **Make sure the camera has been inserted the SD card.**
On this page, you can see the available space of the SD card.
- FTP: The video will be saved in FTP. Please refer to [4.4.8 FTP Settings](#).

Local Recording Location: For Windows OS, the manual recording path is C:/ IPCamRecord, you can change another one. For MAC OS, the manual recording path is: / IPCamRecord.

Enter the local folder: Click here,you can enter the local folder.

4.7.2 Alarm Record

The screenshot shows the 'Alarm Recording' configuration page. At the top, there is a title bar with 'Alarm Recording' in blue. Below the title bar are two buttons: 'Save' and 'Refresh'. The main content area has a checkbox labeled 'Enable Pre-Record' which is checked. Below this are two rows of configuration options:

Pre-recorded Time	5s
Alarm Recording Time	30s

4.7.3 Local Alarm Location

On this page you can enable local alarm record, and select the local alarm record time.

The screenshot shows the 'Local Alarm Recording' configuration page. At the top, there is a title bar with 'Local Alarm Recording' in blue. Below the title bar are two buttons: 'Save' and 'Refresh'. The main content area has a checkbox labeled 'Enable Local Alarm Recording' which is checked. Below this is one row of configuration options:

Local Alarm Recording Time	30s
----------------------------	-----

4.7.4 Schedule Recording

When the video is selected as FTP, the device supports scheduled recording.

The screenshot shows the 'Storage Location' configuration page. At the top, there is a title bar with 'Storage Location' in blue. Below the title bar are two buttons: 'Save' and 'Refresh'. The main content area has two rows of configuration options:

Recording Location	FTP
Local Recording Location	c:\IPCamRecord

There is a 'Browse' button next to the 'Local Recording Location' field.

Scheduled Recording To FTP

Enable Scheduled Recording

Stream:

All	00	01	02	03	04	05	06	07	08	09	10	11	12	13	14	15	16	17	18	19	20	21	22	23
MON																								
TUE																								
WED																								
THU																								
FRI																								
SAT																								
SUN																								

When the video is selected as SD card, the device supports pumping frame recording.

Storage Location

Recording Location: SD card
372.2 MB / 7.4 GB

Local Recording Location:

Scheduled Recording To SD Card

Enable Scheduled Recording

Enable Long-time recording	No
Record frame	30
Record full strategy	Cover
Audio Record	No
Stream	Main stream

All	00	01	02	03	04	05	06	07	08	09	10	11	12	13	14	15	16	17	18	19	20	21	22	23
MON																								
TUE																								
WED																								
THU																								
FRI																								

Record frame: There are six frame selections, such as 1 / 30, 4 / 30, 8 / 30, 15 / 30, 24 / 30, 30 / 30. Recommended default is 4 / 30. The greater the Frame rate is, the sharper picture quality is, and the greater of storage space is, the shorter the storage time is.

Record full strategy: When the SD card is full, you can choose to cover the previous recording, or stop recording.

Audio Record: You can choose **Yes** or **No**.

NOTES:

- Scheduled recording only supports video saved to the SD card or FTP server.
- The schedule recording will stop while alarm recording is beginning, and it will continue automatically after alarm recording end.

4.7.5 SD Card Management

The SD card Slot inside the camera, if you want to install or remove the SD card, you need to open the camera.

When you plug in the SD card during the camera work process, please reboot the camera again, or else the SD Card may be cannot work well.

Go to the **Settings > Status > Device Status** page, you can see the SD card status.

The default storage path of alarm record files is SD card, when the available size of SD card is less than 256M, the old record files will be deleted automatically.

4.8 PTZ (only FI9805E)

This page will allow you to change the pan / tilt speed and do RS485 settings (Only FI9805E have this feature).

4.8.1 Pan / Tilt Speed

There are five Pt speed types: very fast, fast, normal, slow and very slowly. Select the desired pan / tilt speed type and click save button .

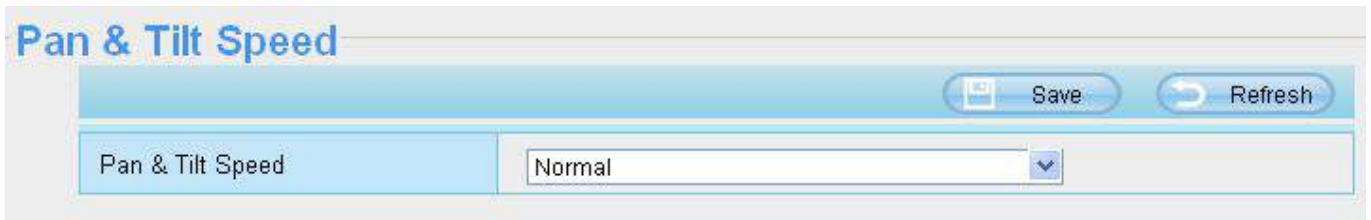

Pan & Tilt Speed	
Pan & Tilt Speed	Normal

4.8.2 RS485 Configuration (Only for FI9805E)

This camera supports the standard 485 cradle head protocol (PELCO-D and PELCO-P). Please configure the RS485 protocol corresponding information first, or else the cradle head may cannot work.



RS485	
Protocol	PELCO-D
Address Code	1
Baud Rate	9600
Data Bits	8
Stop Bits	1
Check	None

4.9 Firewall

This section explains how to control the access permission by checking the client PC's IP addresses. It is composed of the following columns: **Block access from these IP addresses** and **Only allow access from these IP addresses**.

IP Filtering

Save Refresh

Enable Firewall

IP Filtering Block access from these IP addresses ▼

Block access from these IP addresses
Only allow access from these IP addresses

IP Address #1	<input type="text"/>
IP Address #2	<input type="text"/>
IP Address #3	<input type="text"/>
IP Address #4	<input type="text"/>
IP Address #5	<input type="text"/>
IP Address #6	<input type="text"/>
IP Address #7	<input type="text"/>
IP Address #8	<input type="text"/>

Enable firewall, If you select Only allow access from these IP addresses and fill in 8 IP addresses at most, only those clients whose IP addresses listed in the Only allow access from these IP addresses can access the Network Camera. If you select Block access from these IP addresses, only those clients whose IP addresses are in the IP list cannot access the Network Camera.

Click **Save** to take effect.

4.10 System

In this panel, you can back up / restore your camera settings, upgrade the firmware to the latest version, restore the camera to default settings and reboot the device.

4.10.1 Back-up & Restore

Click Backup to save all the parameters you have set. These parameters will be stored in a bin file for future use.

Click Browse and select the parameters file you have stored, then click Submit to restore the restore the parameters.

Backup is used to save your current settings. It is recommended to backup your configuration before modifying or upgrading firmware.

Settings can be restored by uploading the backup file.

Path:

Note:

1. All current settings will be lost when importing a configuration file. If an incorrect file is loaded, the camera may stop working correctly.
2. Keep the power on during this process, or you may damage your camera. Your camera will reboot automatically once restoration is completed.

4.10.2 System Upgrade

Click **Download the Latest Firmware**, you will see the following screen. And click **Save** to save the firmware on your computer locally.

Your current firmware version will be displayed on your screen. You may go to the **Status > Device Information** page to check for the latest firmware versions available.

Click **Browse**, choose the correct bin file and then click **System upgrade**.

Don't shut down the power during upgrading. After upgrading, you can see the upgrade result.

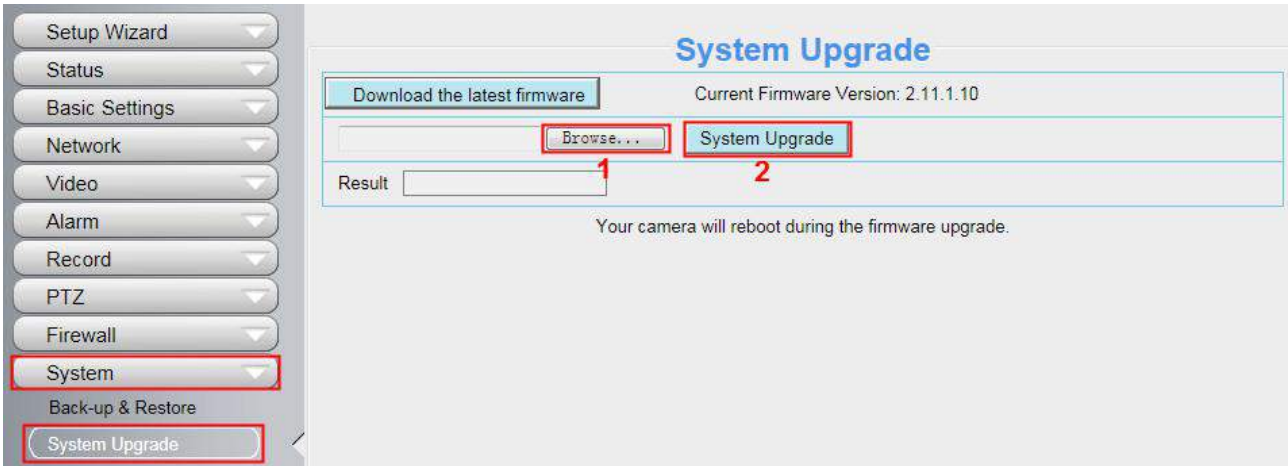

Upgrade Firmware by Equipment Search Tool

Double click the Equipment Search Tool shot icon  , select the Camera IP that you want to upgrade the firmware. Then select Upgrade Firmware and enter the username and password, choose the firmware file, and upgrade.

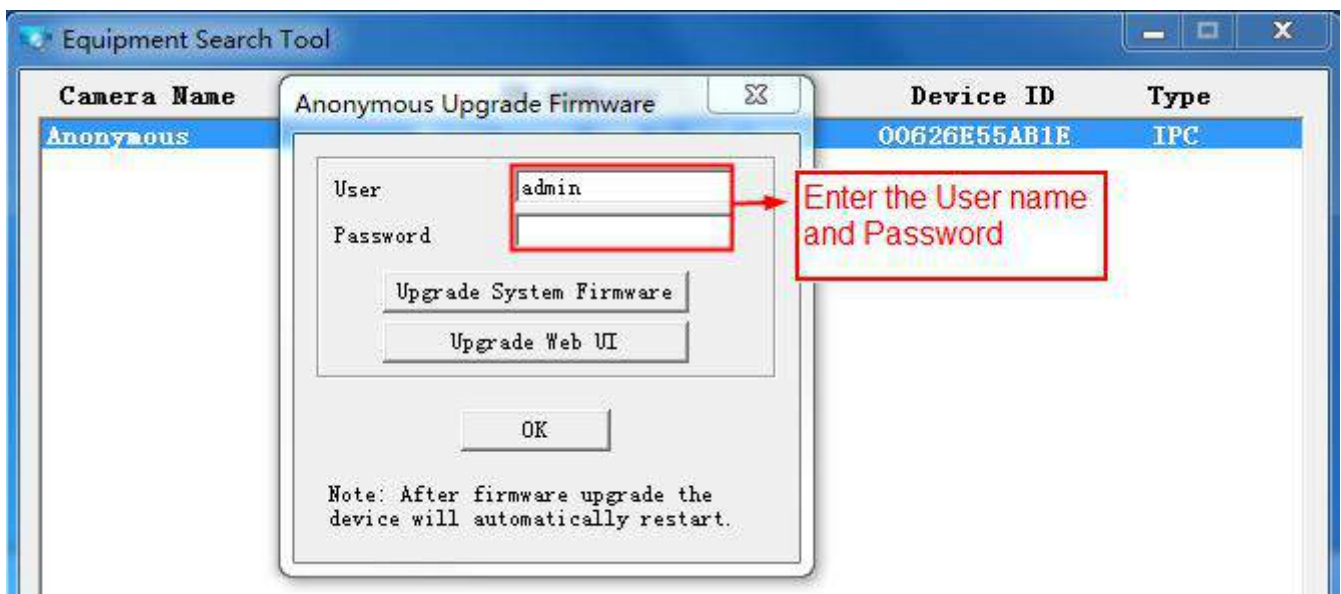
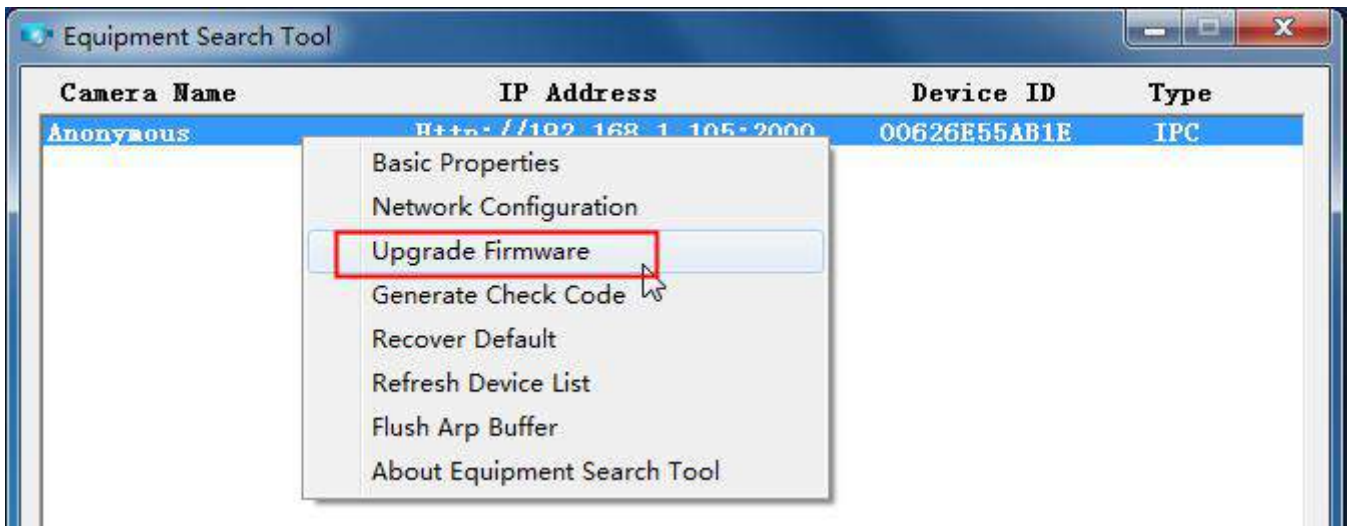

CAUTION:

We recommend that you regularly update your camera to the latest available software and firmware versions to help ensure the best experience for your camera.

NOTE:

- 1) Please ensure you have download the correct firmware package for your camera before upgrading. Read the upgrade documentation (readme.txt file) in the upgrade package before you upgrade.
- 2) Upon downloading the firmware check the sizes of the .bin files. They must match the size in the readme.txt file. If not, please download the firmware again until the sizes are the same. Your camera will not function correctly if a corrupt .bin file is used.
- 3) Never shut down the power of the camera during upgrade until the IP camera restart and get connected.
- 4) After upgrade successfully, please clear the cache of browser, uninstall the old plugin and re-install it, then reset the camera to the default factory settings before using the camera.

4.10.3 Patch Installation

Click **Browse** to select the correct patch file, and then click **Install Patch** to install the patch. Do not turn off the

power during it installing. After installing is complete, you will receive a system prompt.

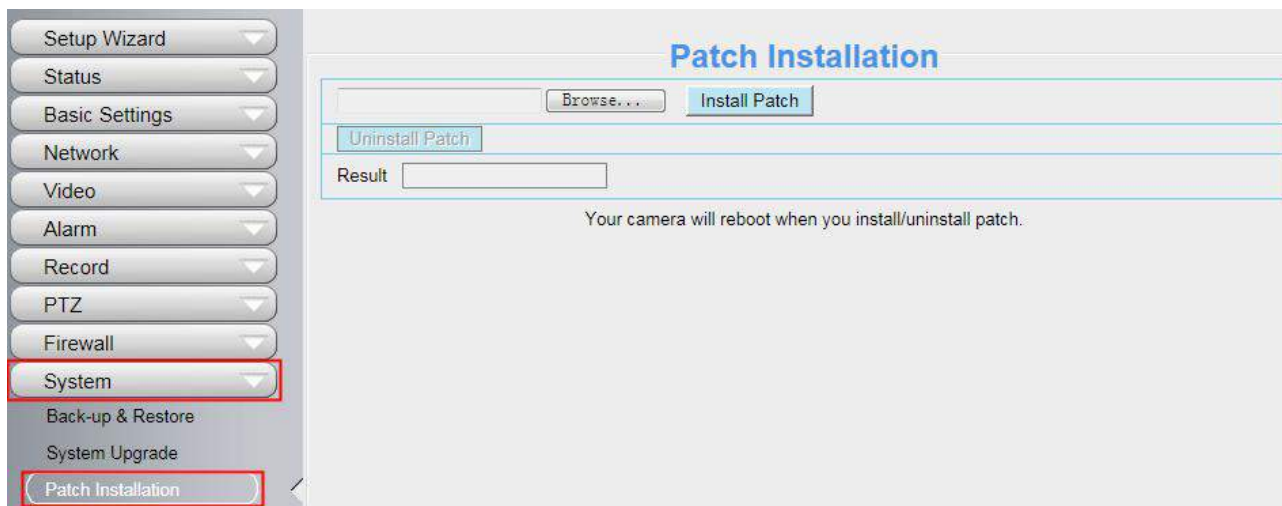

4.10.4 Factory Reset

Click **Factory Reset** button and all parameters will return to factory settings if selected. The default administrator username is admin with a blank password.

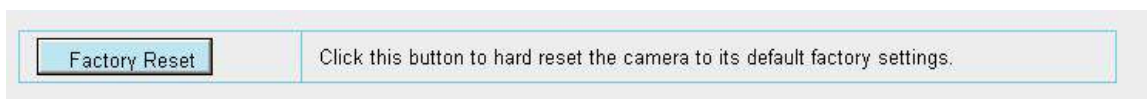

4.10.5 Reboot

Click **Reboot** to reboot the camera. This is similar to unplugging the power to the camera.

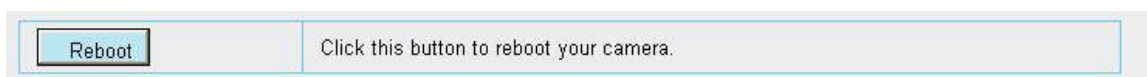

5 Playback

On this page you can view the record files stored in the SD card.

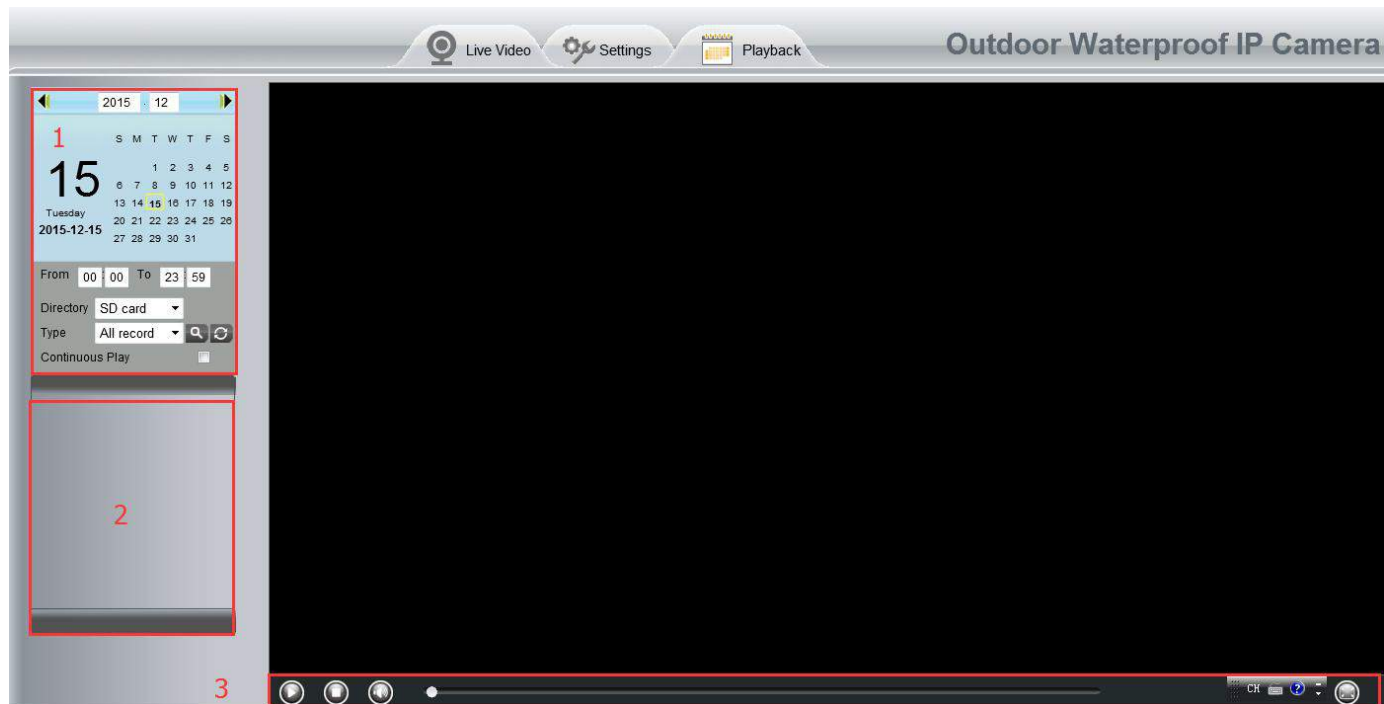

Section 1 Define the Record files time and Type

Directory: : The storage path of record files

Time: : Here supports three types: current day, current month and All records. Another way, select the time on the time&date manually.



Type: : The type of records files, Here supports two types: Normal record, Alarm record and All records.

: Click this button to search all record files satisfy the conditions you selected.

Continuous Play: Select the checkbox to play continuously all the record files.

Section 2 Search record files

On this panel you can see all record files satisfy the conditions you set.

Section 3 Play / Stop / Audio / Full screen Buttons

Please select one record file before use these buttons.



Click this button to play the record files



Click this button to stop the record files



Open or stop audio



Click this button to make full screen, and double click left mouse to exit full screen.

6 Appendix

6.1 Frequently Asked Questions

NOTE: Any questions you would meet, please check Network connections firstly. Check the working status revealed by the indicators on the network server, hub, and exchange. If abnormal, check the network connections.

6.1.1 Equipment search tool cannot find the camera

After power on camera and connect it to router by Ethernet cable, open Equipment Search Tool it cannot find any camera IP address. Shows a blank window like below.

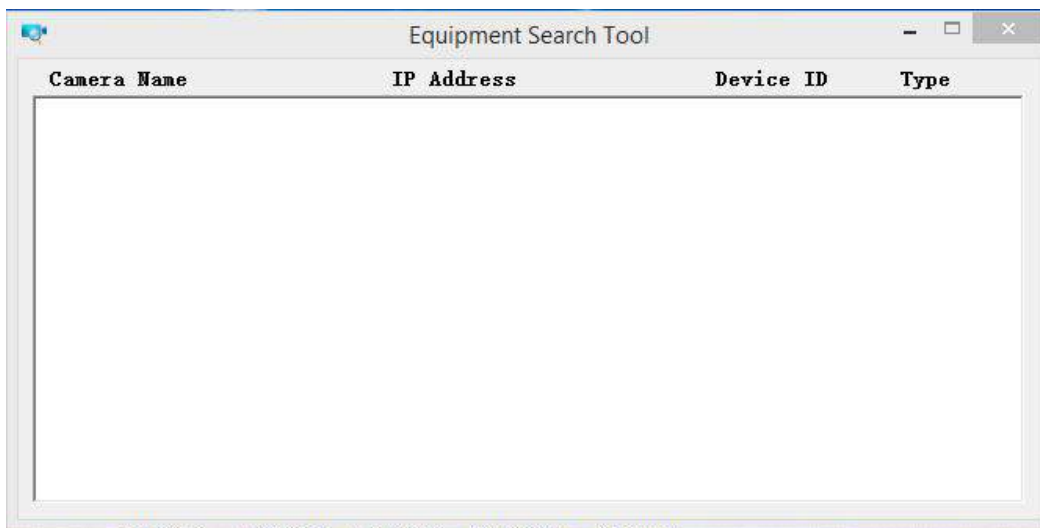

This is usually because camera doesn't get an IP in same network segment as the computer. Please follow below steps to fix the problem.

1. Make sure both camera and computer are connected to same router.
2. Make sure camera's connected to router properly and camera status is normal.
For indoor pan/tilt cameras, when powered on you will see a red power light and camera will pan/tilt. And on LAN port you'll see a blinking orange light and a solid green light.
3. Reset camera to have a check. Just keep pressing rest button on camera with power on for about 30 seconds till it reboot. Reset button is usually on back/bottom of camera, or on the end cords.
4. Try another Ethernet cable or hook into another LAN port on router.
5. Make sure the router DHCP server is enabled and there is no Mac address filter.
Check router's DHCP list as well, to see if you can find camera's IP address there.
If yes, please try to log-in the camera directly by manually input the IP address and port (default http port: for SD camera is 80, for HD camera is 88) of camera into address bar of web browser.
6. Please turn off any virtual machine or multiple connection (use only wired or wireless connection) that is running on computer.
7. At latest make sure there's no firewall is blocking Equipment Search Tool or other search tool conflicts with it.

6.1.2 Install plugin for Internet Explore

Suggest use IE browser to log in the camera and install the plugin for the first time, then you can use it on other browser as well. Just remember to allow the plugin to run. See below for steps to install plugin via IE browser.

Step 1: User IE browser to log in the camera for the first time, it will prompt to ask your install the plugin on the bottom of IE browser.

Step 2: Click **Install** to continue the installation of the .exe plugin.

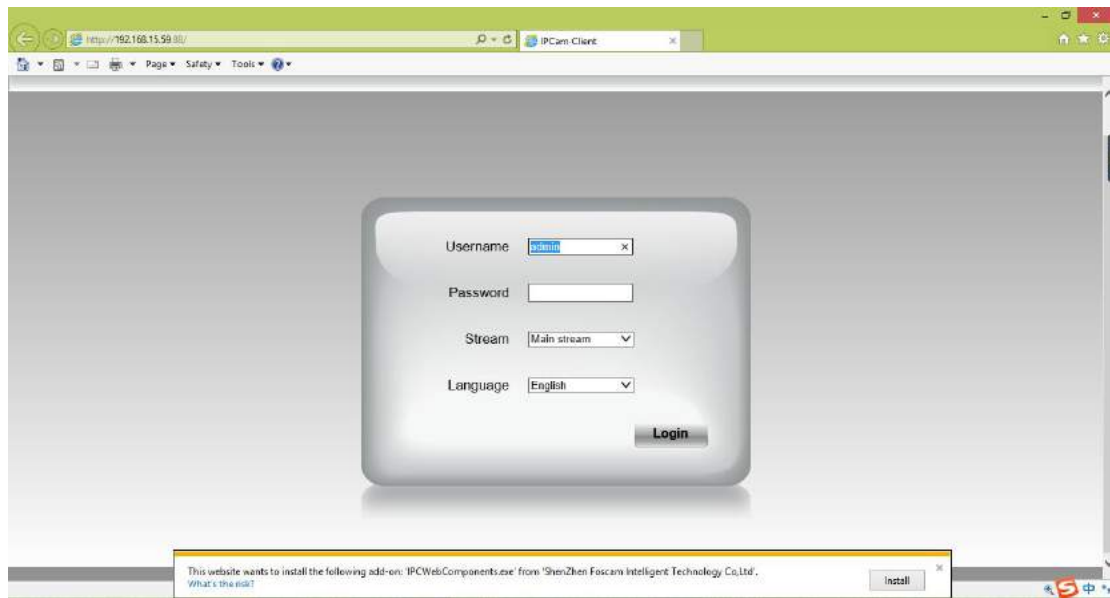

Step 3: Follow the Setup Wizard to finished installing the plugin

Note: When starting to install the plug-in, it will force to close the IE browser. Please click **Yes** to close the IE browser firstly.

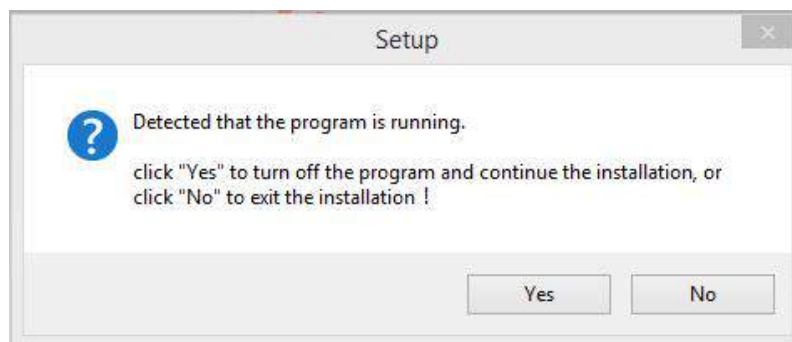

And click **Next** to follow the setup wizard.

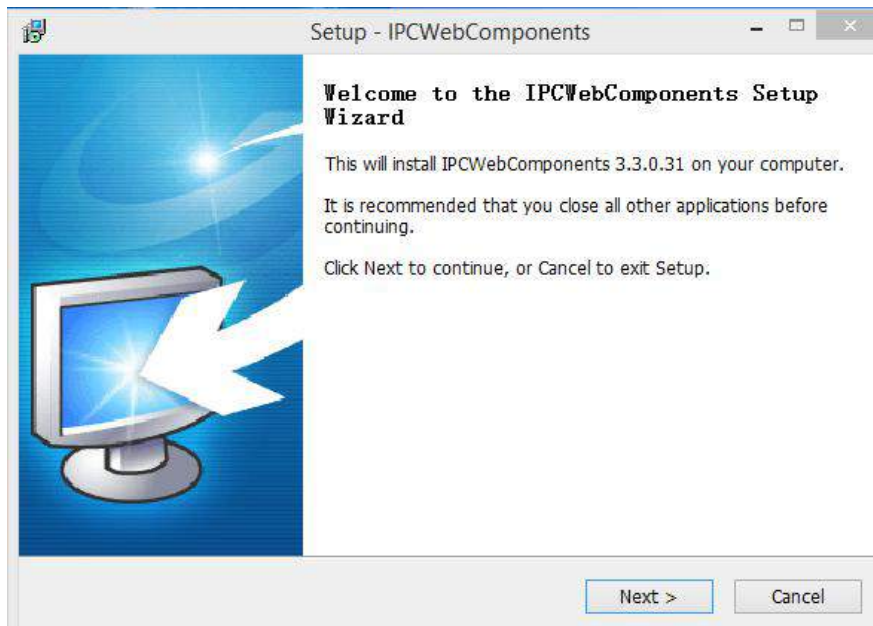

Step 4: Click **Finish** and reboot IE browser to log in the camera.

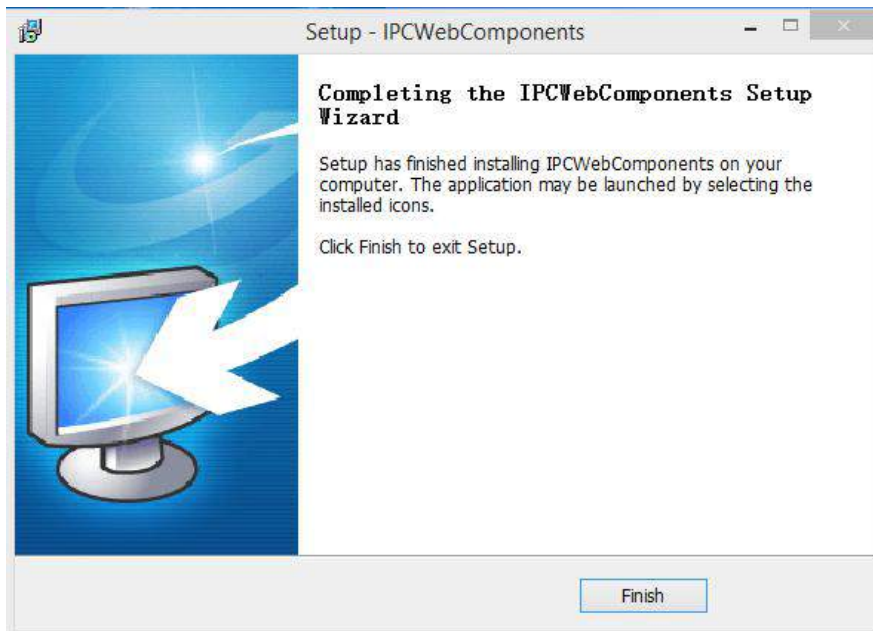

Note, for Safari on MAC OSX it'll show a link "Plugins are not found, click me to download" just above login windows of the camera. Please click it to download plugin and follow wizard to install. See this link for help if after installed plugin but still cannot login camera:

<http://bit.ly/2EvidDS>

6.1.3 Unable to connect to router wirelessly

After setup wireless configuration, and input the wireless password correctly, save the settings. Normally, after you disconnect the Ethernet cable, wait for few minutes camera will show up again in Equipment Search Tool (or show up in router's DHCP client list/LAN list) with a new IP address. That indicates your camera's connected wirelessly.

If not, please follow below steps to help camera connect wirelessly.

Step1: Please make sure wireless signal is strong enough to connect with.

- (1) Make sure the camera antenna is fixed well;
- (2) Best to keep the distance between the camera and router in 2~3 meters while setup;
- (3) There's no interference or obstacles from house appliance or walls;

Step2: Please check if the frequency band of the wireless signal is 2.4GHz.

Our cameras only support connecting to 2.4GHz frequency wireless band. If your wireless router is dual band, that supports two frequency band 2.4GHz and 5GHz.

Please set the 2.4GHz and 5GHz with different SSIDs, and make sure configure camera to connect with the 2.4GHz SSID.

Step3: Please check if your wireless password contains special characters.

Remove special character in SSID and wireless password to have a try.

Step 4: Reboot camera and router to have a check.

If above are all confirmed, power off and on the camera and router may help camera to connect.

Step 5: Please log-in the router and check if the MAC filter feature is enabled.

Camera has wired and wireless MAC, they are different. If your router has wireless MAC filtering turned on, it'll block camera to connect. Please turn it off, or add camera's MACs in the allow list.

Step 6: Please change the wireless channel, and the wireless encryption of router to have a try.

Change channel helps reduce influence from nearby WiFi networks, you can try 3,6,or 11 for example. As for encryption, suggest use WPA2/PSK AES.

Step7: At last reset camera to default, and please try re-configure the wireless settings again.

6.1.4 Unable to access camera from internet via DDNS

Before camera can be accessed remotely via DDNS, below steps need configure correctly:

- (1) Set a static IP for camera
- (2) Enable DDNS
- (3) And do port forwarding on router

Once done, DDNS will success to sync with external IP and camera's port will be open.

If camera won't work remotely, cloud be port forwarding is not working or DDNS is not synced.

Go to website such as www.canyouseeme.org input port of camera and click Check Port, you'll see whether port of your camera is open.

But if port is closed, below tips can help get port open:

- (1) Double check to make sure port forwarding settings on the router is correct.
- (2) Check if there's more than one router in network.

If yes, you need also need do port forwarding twice.

(3) Change the http port, then re-do port forwarding on router. In case current port is taken by other service.

(4) Some ISP may also block some ports, if above steps failed try consult with your ISP directly to open the port for you.

Go to camera **Status > Device Status** menu, and you can check if camera's DDNS is successful. For the case DDNS shows failed, please follow below tips to help it synchronize:

(1) Change DNS server to 8.8.8.8.

Please login camera's web-page, and go to the IP configuration (For HD cameras) or basic network settings (For SD cameras) menu to make the change.

(2) Reboot the camera and router, wait a few minutes to check again.

(3) Use a 3rd party DDNS instead, like No-IP, to see if it works.

6.1.5 Forgot camera's user name and password

Camera can be hard reset to default settings, when you forgot camera's login user name and password. Below are the steps:

(1) Keep power on camera;

(2) Press and hold reset button of camera for 30 second, till it reboots. Reset button is on bottom, or back, or end cords of the camera.

(3) Once reset, camera will be restored to default settings. And default username is admin, no password (leave password blank).

6.1.6 How to setup alarm recording to SD card

For the cameras that support SD card, we can save alarm recording on SD card and below are the steps to set it up:

Step 1: Setup the Motion Detection Settings

Please go to **Settings > Alarm > Motion Detection** menu.

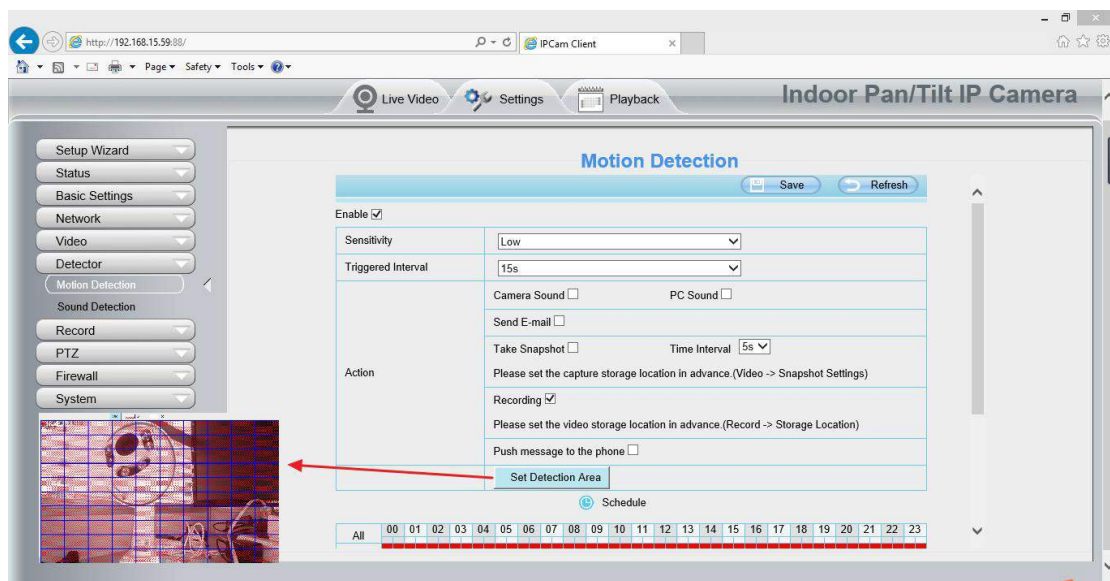

Note:

- 1) Please DO NOT forget to set the alarm schedule, the alarm schedule is red.
- 2) Please make sure your camera time is correct.
- 3) Please DO NOT forget to set the alarm area, the detected area is covered by the red grids. Or for some models you can setup 3 detection zones in total.

Step 2: Setup the Storage Location

Go to **Settings > Record > Storage Location**, and set the "Recording Location" to "SD card" and click **Save**.

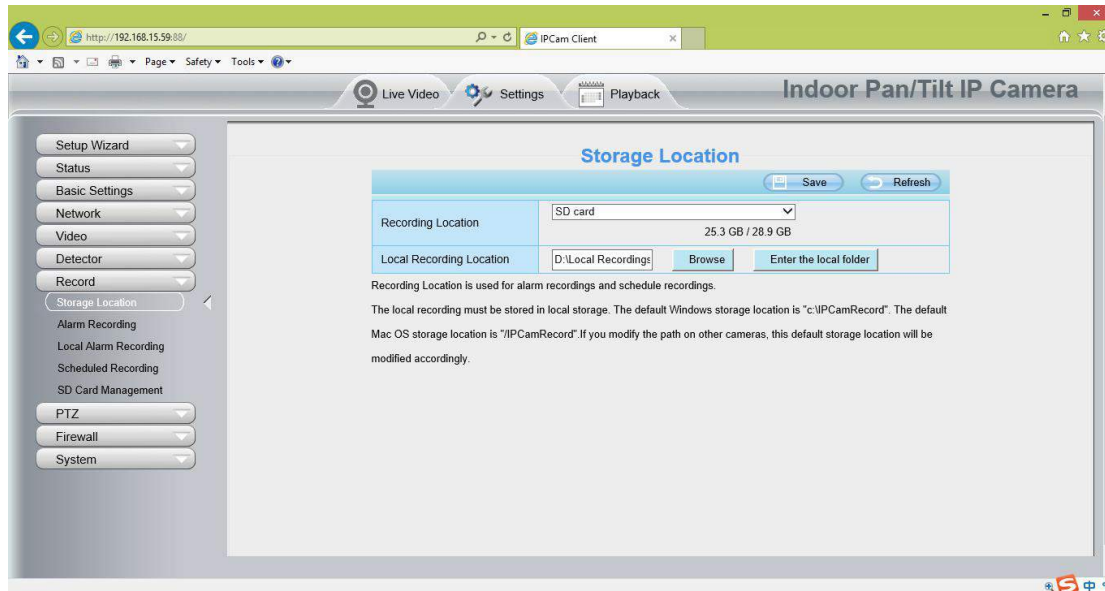

Note:

SD card needs format correctly so it'll be identified by camera, and has enough space for saving the recordings. It's suggested to use FAT32 for 4G~32G SD card and exFAT for 64G and above SD card.

6.1.7 How to setup alarm Emails

Setup alarm Emails, when camera detects a motion it'll send Email with snapshot to inform about the motion alarm. Steps as below.

Step 1: Setup Mail Settings

Before you set, please make sure that your email for sender enabled SMTP. And get your Email SMTP server, SMTP port, TLS information ready.

Please go to **Settings > Network > Mail Settings** menu to setup your email firstly.

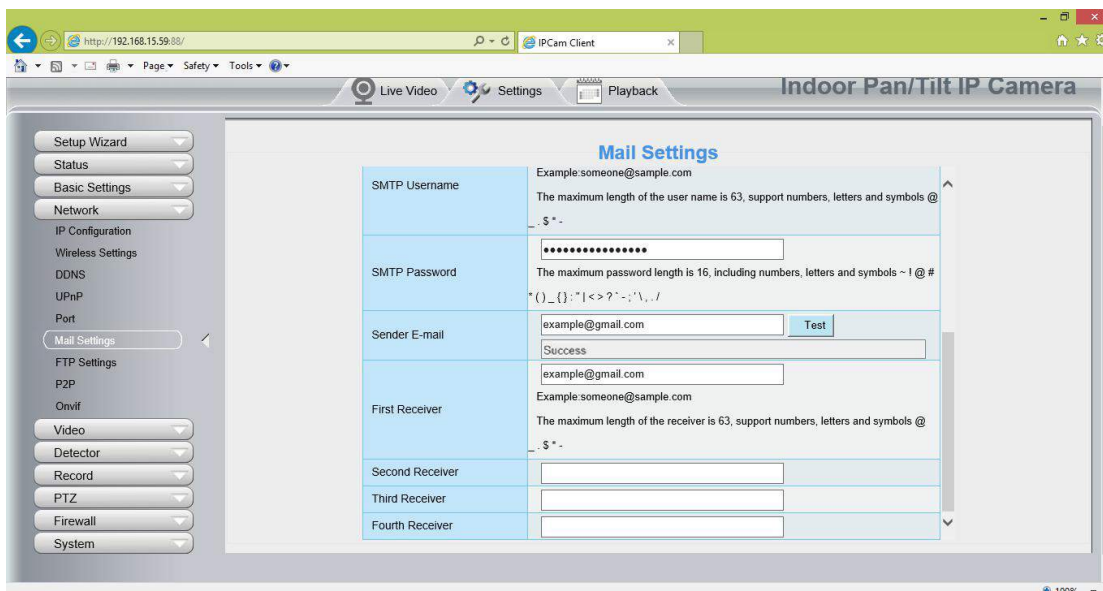
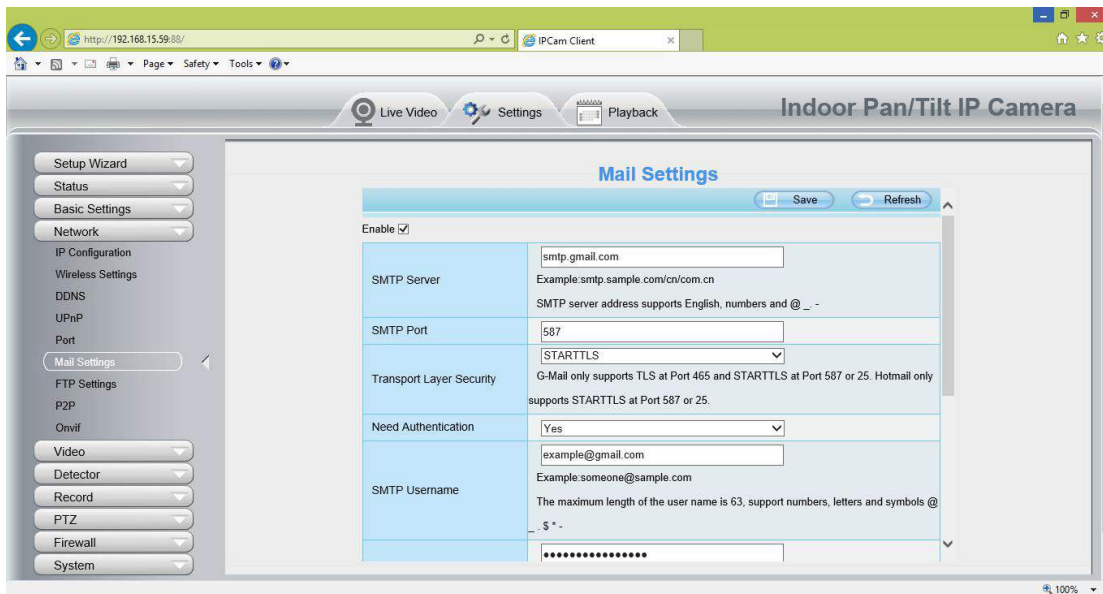

Note:

- (1) Please make sure that your sender email supports SMTP;
- (2) Please click on **Save** before you click on **Test**;
- (3) Make sure the test result is success.
- (4) After succeed, you will receive a test email in the mailbox of Sender.

Step 2: Setup the Motion Alarm Settings

Please go to **Settings > Alarm > Motion Detection** menu:

1. Click **enable**,
2. Choose **Send E-mail** for the alarm action,
3. set your detection area,
4. Set your schedule.

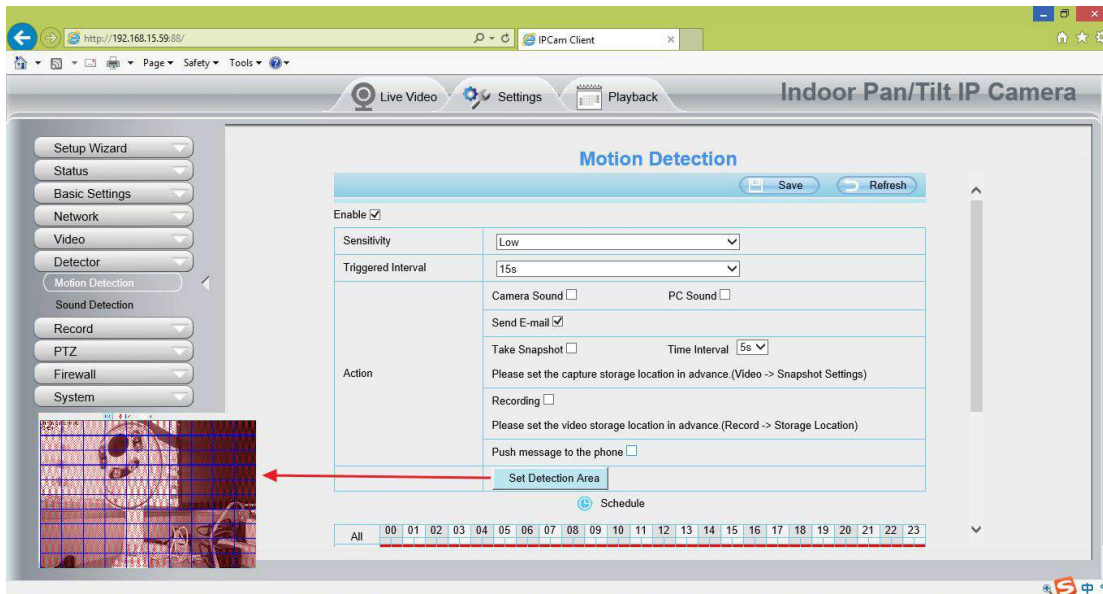

Do not forget to click on **Save** after you finish settings.

If there is motion trigger, camera will alarm and you can receive alarm emails.

Note:

- (1) Please DO NOT forget to set the alarm schedule, the alarm schedule is red.
- (2) Please make sure your camera time is correct.
- (3) Please DO NOT forget to set the alarm area, the detected area is covered by the red grids. Or for some models you can setup 3 detection zones in total.

6.1.8 Camera is not displaying image

Camera unable to show live image on web browser cloud be caused by multiple factors.

- (1) Plugin is not installed or running properly.

Please install plugin first, go to **IE Browser > Tool > Internet Option > Security > Custom Level > ActiveX control and Plug-ins**. Three options of front should be set to be **Enable**, The ActiveX programs read by the computer will be stored. As follows:

Enable: Download unsigned ActiveX controls.

Enable: Initialize and script ActiveX controls not marked as safe.

Enable: Run ActiveX controls and plug-ins.

- (2) Low network bandwidth that's unable to transfer image. Please lower resolution of the camera.
- (3) IR-cut is stuck at night when IR lights are on. In this case, manually turn off and on IR lights a few times.
- (4) Also, if camera's firmware is too old that doesn't support the browser and unable to install plugin will cause the same issue. Please update firmware of the camera to latest first.

6.1.9 Unable to connect camera remotely using app

P2P cameras allow users to connect camera remotely using app without extract setup like port forwarding.

When it unable to connect remotely, below tips can help app establish the connection:

- (1) Update app and camera's firmware to latest version,
- (2) Power off the camera then power back on,
- (3) Delete camera from app then re-add it back, also lower camera's resolution.

6.1.10 Camera is added by others

When using cloud or app, one camera can only be added to one account at the same time.

6.2 Default Parameters

Default network parameters

IP address: obtain dynamically

Subnet mask: obtain dynamically

Gateway: obtain dynamically

DDNS: Embedded DDNS Service

Username and password

Default admin username: admin with a blank password

6.3 Specification

ITEMS		
Image Sensor	Sensor	High Definition Color CMOS Sensor
	Display Resolution	1920 * 1080 (2.0M Pixels)
	Min. Illumination	0 Lux (With IR Illuminator)
Lens	Lens Type	Glass Lens
	focal length	f:4mm / 2.8mm
	Aperture	F1.2
	Angle of view	When f=4mm, Horizontal: 70°, Diagonal: 78° When f=2.8mm, Horizontal: 106°, Diagonal: 118°
Video	Image Compression	H.264
	Image Frame Rate	30fps (60Hz), 25fps (50Hz), downward adjustable
	Resolution	1080P (1920 * 1080), 720P (1280 * 720), VGA (640 * 480), QVGA (320 * 240)
	Stream	dual stream
	Image adjustment	The hue, brightness, contrast, saturation, sharpness are adjustable
	Flip image	flip and mirror
	Infrared mode	Automatic or manual
	IR range	With 30pcs IR-LED, IR LEDs for IR range up to 20m / 66ft
Audio	Input / Output	External RCA interface for two-way audio
	Audio Compression	PCM / G.726
Network	Ethernet	One 10/100Mbps RJ45 port

	Wireless Standard	IEEE802.11b / g / n
	Data Rate	IEEE802.11b: 11Mbps (Max.); IEEE802.11g: 54Mbps (Max.); IEEE802.11n: 150Mbps (Max.).
	Frequency bands	2412-2472MHz
	Maximum power	18dBm
	Wireless Security	WEP, WPA, WPA2
	Remote Access	P2P DDNS
	Network Protocol	IP, TCP, UDP, HTTP, HTTPS, SMTP, FTP, DHCP, DDNS, UPnP, RTSP, ONVIF
System Requirements	Operating System	Microsoft Windows 2000/XP, Vista 7,8; Mac OS
	Browser	Microsoft IE8 and above version or compatible browser; Mozilla Firefox; Google Chrome; Apple Safari.
Other Features	Motion Detection	Alarm via E-mail, upload alarm snapshot to FTP
	Privacy Block	Set privacy area manually
	User Accounts	Three levels user role
	Firewall	Supports IP Filtering
	Reset	Reset button is available
Power	Power Supply	DC 12V / 1.0A
	Power Consumption	5 Watts (Max.)
Physical	Dimension (L * W * H)	97mm * 67mm * 64mm / 3.8in * 2.6in * 2.5in
	Net Weight	255g / 0.6lb
Environment	Waterproof	IP66
	Operating Temperature	-10°C~ 60°C (14°F ~ 140°F)
	Operating Humidity	10% ~ 80% non-condensing
	Storage Temperature	-20°C ~ 60°C (-4°F ~ 140°F)
	Storage Humidity	0% ~ 90% non-condensing
Certification	FCC, IC, CE, RoHS, IP66	

Attention: Power adapter should be used between -20°C ~ 40°C, and 20%-90% relative humidity.

6.4 CE & FCC

Electromagnetic Compatibility (EMC)

FCC Statement



This device complies with FCC Rules Part 15 of the FCC Rules. Operation is subject to the following two conditions.

- This device may not cause harmful interference, and
- This device must accept any interference received, including interference that may cause undesired operation.

These equipments have been tested and found to comply with the limits for Class A digital devices, pursuant to Part 15 of the FCC Rules. These limits are designed to provide reasonable protection against harmful interference when the equipment is operated in a commercial environment. This equipment generates, uses, and can radiate radio frequency energy and, if not installed and used in accordance with the installation manual, may cause harmful interference to radio communications. Operation of this equipment in a residential area is like to cause harmful interference, in which case the user will be required to correct the interference at his own expense.

FCC Caution

Any changes or modification not expressly approved by the party responsible for compliance could void the user's authority to operate this equipment.

This equipment complies with FCC radiation exposure limits set forth for an uncontrolled environment. This equipment should be installed and operated with minimum distance 20cm (7.9in) between the radiator& your body.

This transmitter must not be co-located or operating in conjunction with any other antenna or transmitter.

CE Mark Warning



This is a Class A product. In a domestic environment, this product may cause radio interference, in which case the user may be required to take adequate measures.