

# CCM-1A

## Color Camera Module

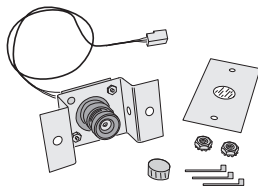

### Installation Instructions

**Linear**  
Building the Innovation.

USA & Canada (800) 421-1587 & (800) 352-0123  
(760) 438-7000 - Toll Free FAX (800) 468-1340  
www.linearcorp.com

### PRODUCT DESCRIPTION

Linear's Model CCM-1A (P/N ACP00904A) CCTV camera can be installed inside the AE-100, AE-500, AE1000Plus or AE2000Plus access control systems. The camera provides a video signal for viewing the area in front of the system. The camera is continuously powered by the access system. Focus has been factory adjusted to a range of three to four feet. No adjustment is needed. The AE1000Plus and AE2000Plus provide a video jack for connection to a video cable with a Type "BNC" connector. Up to 400 feet of 75-ohm RG-59 video cable can be used. Longer cable runs may require the use of a video amplifier.

**NOTE:** If camera is being installed on an existing installation, system power should be off prior to installing the camera.

### 1. REMOVE THE COVER PLATE

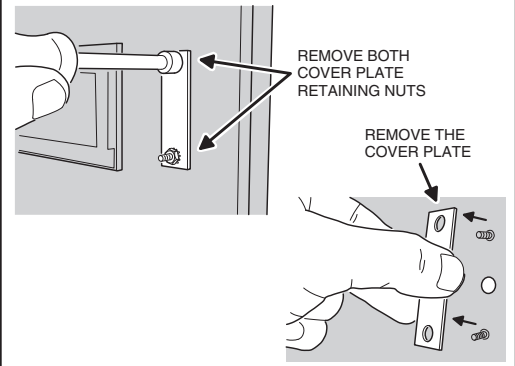

### 2. INSTALL THE WINDOW

AE-100 AE-500, AE1000Plus AND AE2000Plus ONLY

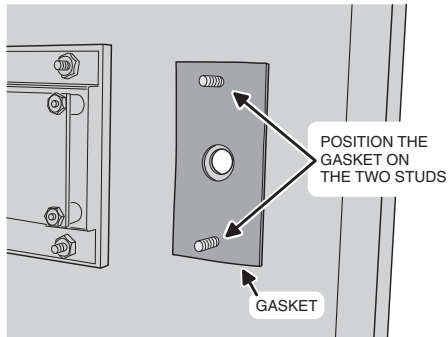

### 5. CONNECT THE CAMERA AND VIDEO CABLE

**CAUTION!** BE SURE THE SYSTEM POWER IS OFF

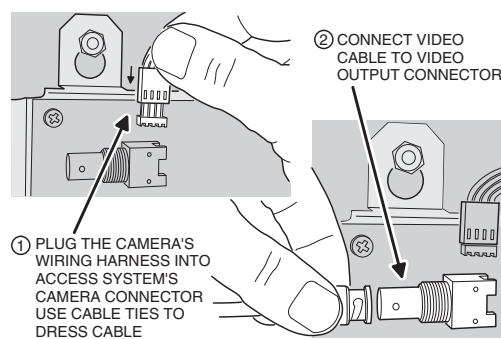

### 3. REMOVE THE LENS CAP

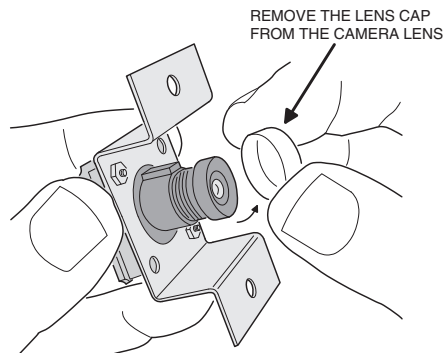

### 4. INSTALL THE CAMERA

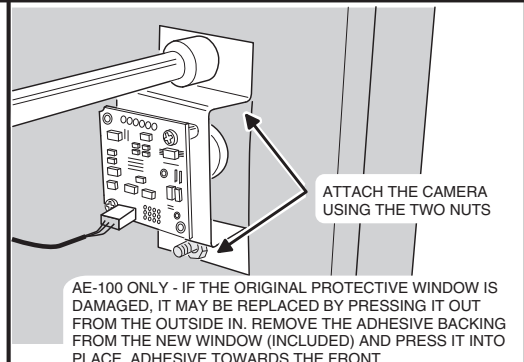

AE-100 ONLY - IF THE ORIGINAL PROTECTIVE WINDOW IS DAMAGED, IT MAY BE REPLACED BY PRESSING IT OUT FROM THE OUTSIDE IN. REMOVE THE ADHESIVE BACKING FROM THE NEW WINDOW (INCLUDED) AND PRESS IT INTO PLACE, ADHESIVE TOWARDS THE FRONT.

### 6. TEST CAMERA

APPLY POWER TO THE ACCESS SYSTEM THEN VIEW THE VIDEO MONITOR TO TEST THE VIDEO OUTPUT FROM THE CAMERA

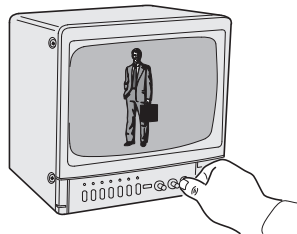

### LINEAR LIMITED WARRANTY

This Linear product is warranted against defects in material and workmanship for twenty four (24) months. The Warranty Expiration Date is labeled on the product. **This warranty extends only to wholesale customers** who buy direct from Linear or through Linear's normal distribution channels. **Linear does not warrant this product to consumers.** Consumers should inquire from their selling dealer as to the nature of the dealer's warranty, if any. **There are no obligations or liabilities on the part of Linear Corporation for consequential damages arising out of or in connection with use or performance of this product or other indirect damages with respect to loss of property, revenue, or profit, or cost of removal, installation, or reinstallation.** All implied warranties, including implied warranties for merchantability and implied warranties for fitness, are valid only until Warranty Expiration Date as labeled on the product. **This Linear Corporation Warranty is in lieu of all other warranties express or implied.**

All products returned for warranty service require a Return Product Authorization Number (RPA#). Contact Linear Technical Services at 1-800-421-1587 for an RPA# and other important details.

**FCC NOTICE:** This device complies with FCC Rules Part 15. Operation is subject to the following two conditions: (1) This device may not cause harmful interference, and (2) This device must accept any interference received, including interference that may cause undesired operation.