

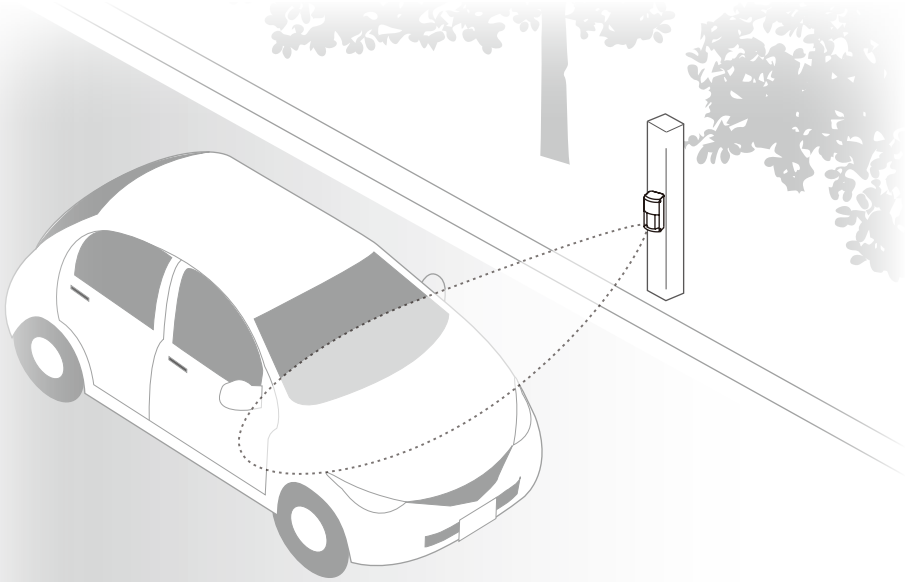

## Vehicle Detection Sensor for Vehicle Counting

# OVS-01CC



### Features

- The sensor can count moving vehicles by using dual detection technologies : Doppler shift and FMCW (Frequency-modulated continuous-wave).
- Detection of objects other than a vehicle can be reduced (patent pending).
- Built-in heater reduces snow on the sensor (automatically activates based on the outside air temperature).
- Not affected by underground obstructions, this product is installed above ground.
- Reduced installation time as access road for vehicle is not closed, as no civil engineering works is required.

### Table of Contents

1	Safety Precautions	2
2	Component Name	3
3	Before Using the Product	4
3-1	Detection Principle and Basic Operation of the Sensor	4
3-2	Sensor Installation Recommendations	5
3-3	Sensor Detection Conditions	7
3-4	Installation Workflow	8
4	Installation Steps (Basic)	10
4-1	Installing the Main Units	10
4-2	Setting Verification and Adjustment	13
4-3	Calibration	14
4-4	Detection Area Check	15
4-5	Other Functions	17
5	Advanced Installation	18
5-1	Sensitivity	18
6	Troubleshooting	19
7	Specifications	20
7-1	Specifications	20
7-2	Detection Area Diagram	21
7-3	Dimensions	21
8	Accessory	21



# 1 Safety Precautions

This product is a vehicle detection sensor designed for a car counting , installed beside a drive way. Do not use the product for other purposes.



## For Safe Use

### About the Marks





The description given here is for correct usage of the product without causing damage to you, other personnel as well as damage to properties. The marks and their meanings are as follows: Please read the text after understanding the contents well.

 <b>WARNING</b>	Failure to follow the instructions provided with this indication and improper handling may cause death or serious injury.
 <b>CAUTION</b>	Failure to follow the instructions provided with this indication and improper handling may cause injury and/or property damage.





### EXAMPLES OF GRAPHICAL INDICATION

	The ⚠ symbol indicates what you need to pay attention to (including warning). The specific warnings are indicated in the symbol (the figure to the left indicates danger of electric shock).
	The ⓧ symbol indicates prohibition. The specific warnings are indicated in or near the symbol (the figure to the left indicates prohibition of disassembly).
	The ● symbol indicates a compulsory conduct or an item to be observed. The specific instructions are indicated in or near the symbol (the figure to the left indicates that power should be turned off).

## WARNING

 Do not touch with wet hands	Do not touch the main unit or the power supply terminal with wet hands (Do not touch them when hands are wet with rain as well). Electric shock may occur.
 Do not disassemble or remodel the unit	NEVER perform disassembly or modification of the unit which is dangerous. Fire or electric shock may occur.
 Turn OFF the system power in case of abnormality	Should you use the unit under abnormal conditions if there is smoke or a smell, it may cause fire, electric shock, or burns. Immediately turn off the power and contact the contractor.
 Use the unit within the scope of its specifications	Use the unit within the scope of the specifications designated by this document. The unit will not work properly and fire or electric shock may occur.
 Always turn off the power during installation	Always turn off the unit's power on installation and/or wiring. Electric shock may occur.

## CAUTION

 Do not water the unit with high pressure water	Do not water the unit with bucket, hose, and/or high pressure washing machine. Water may get in the unit and cause damage.
 Perform wiring tightly and surely	Follow the steps described in this document for wiring. Fire or electric shock may occur.
 Fix tightly	Follow the steps described in this document when attaching the unit to a pole. The units may fall or its cable may become loose, resulting in injury, fire, and/or electric shock.
 Install and configure the units properly	Follow the steps described in this document for proper installation, configuration, and operation check. It may result in a failure of vehicle detection.
 Regularly clean the unit	Please clean the unit regularly. If you find any abnormality, do not use it.

## 2 Component Name

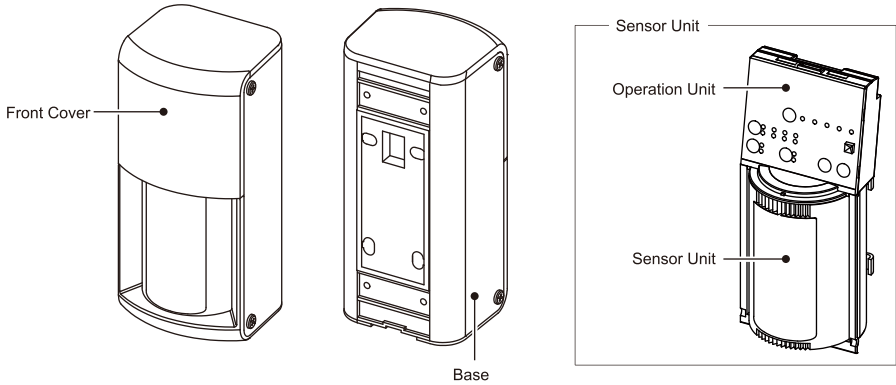

### ■ Operation Unit

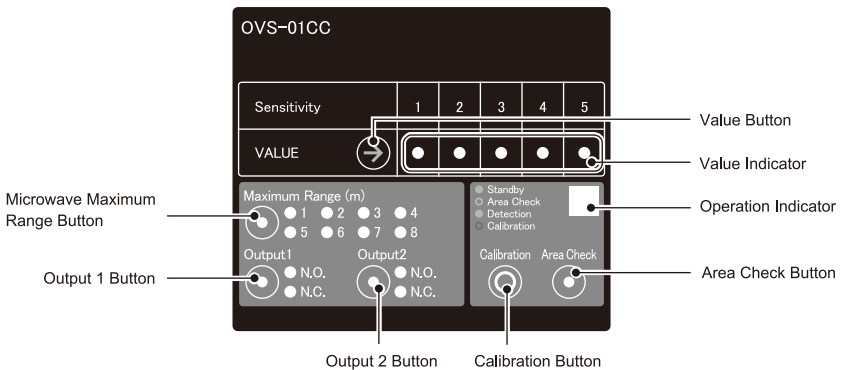

### ● Operation Indicator

Standard Operation	Standby: Solid Green, Detected: Solid Red
Detection Area Check	Non detection: Blinking Green, Detected: Blinking Red
Calibration	Getting Ready: Slow Blinking Blue, Calibrating: Quick Blinking Blue
Sensor Reset	Reset Complete: Solid Yellow for 2 seconds

### ■ Terminal Block

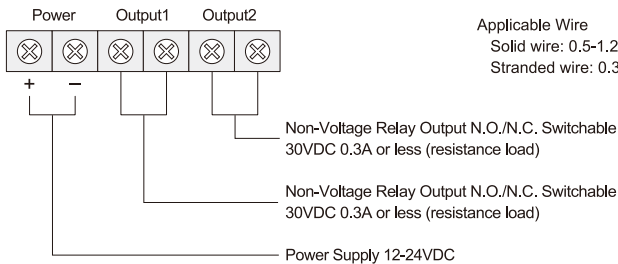

#### Applicable Wire

Solid wire: 0.5-1.2mm (AWG 30-16)

Stranded wire: 0.3-2.0sq (AWG 22-14)

## 3 Before Using the Product

### 3-1 Detection Principle and Basic Operation of the Sensor

- Detection Principle
  - This sensor uses reflection of a microwave signal to detect a vehicle.  
(The higher the reflection, the easier the detection becomes.)
  - The microwave sensor uses FMCW technology, it can detect a vehicle in the lot.
  - The detection logic is shown below.

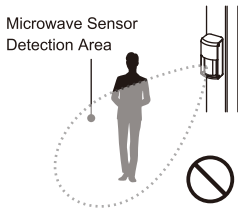

If only a person enters into the detection area, the relay signal output will not trigger (It may detect, however if a crowd of pedestrian or a person with luggage).

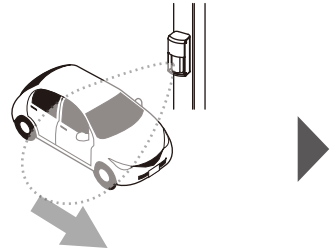

When a vehicle is present, the sensor detects the vehicle.

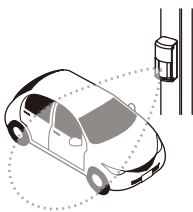

If a vehicle is parked in the detection area, the sensor will maintain the detection status.

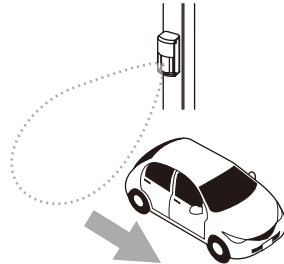

When the vehicle leaves the detection area, the sensor will change to a non-detection status.

#### NOTE

The following cases may occur due to the sensor detection principles.

- If a pedestrian or an object is in the detection area after the Vehicle leaves, the sensor will maintain the detection status even if the vehicle leaves the detection area.  
The sensor may not revert back to a non-detection status if a flag/banner, tall weeds, and/or snow remain.
- If one vehicle tailgates another vehicle very closely when entering the detection area, they may be recognized as one vehicle.

## 3-2 Sensor Installation Recommendations

Install the pole for the sensor in the following layout configuration. The sensor will not work correctly unless its installation direction and height are correct.

Installation height: 500mm(19.69in.) from the ground to the bottom of the sensor

Installation angle: 90 degrees to the vehicle direction of travel.

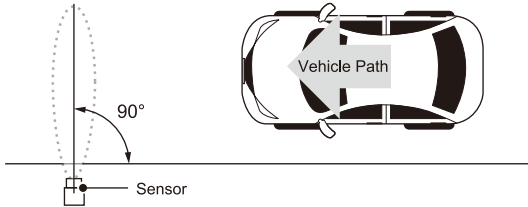

Two way traffic lane : Install the sensor on the the lane of traffic you wish to monitor.  
The sensor cannot detect a vehicle in the opposite lane.

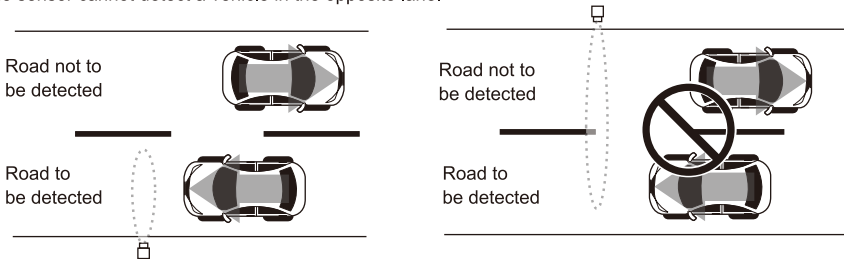

### NOTE

- Two way traffic lane : To use the sensor for a two-way traffic road, adjust the sensing distance so that the detection area should not cover the opposite lane (see P.13 "4-2. Setting Verification and Modification").

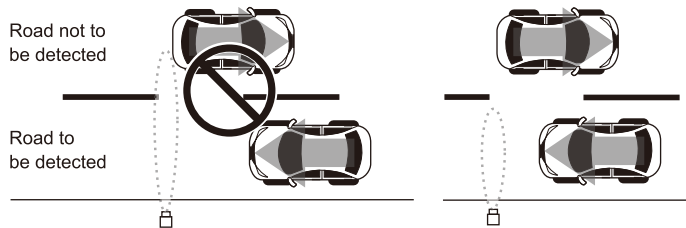

- Always install the sensor on the vertical pole that is mounted in or on the ground. Installing a sensor on a tilted pole will result in a detection of the ground by the sensor and correct operation is not ensured.

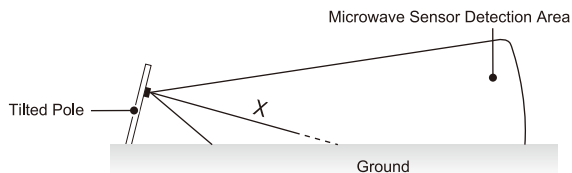

## NOTE

- Please adjust so that the detection area is parallel to the road surface. Some vertical adjustment maybe required if the road surface rises or falls away from the sensors mounting height.

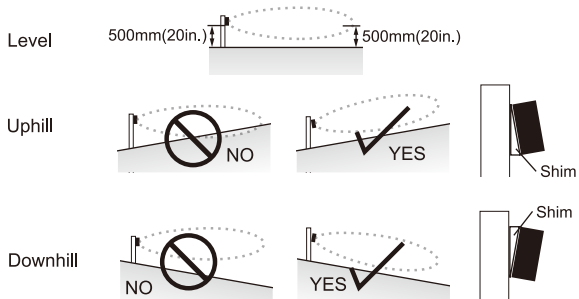

- Do not install any moving object such as flags or banners in the sensor's detection area. Remove any vegetation from the detection area, or reconfigure the detection area to be smaller. Not following these steps may stop the sensor reverting back to non-detection status or delay the change of status.
- Do not use a fluorescent lamp around the detection area. It may prevent proper operation of the sensor.

## 3-3 Sensor Detection Recommendations

---

- A vehicle is detected when it approaches the sensor at speeds of 2 to 60kph (1.2 to 37.3mph).

### NOTE

The following cases may occur due to the sensor's characteristics.

- The sensor may not work properly if it is installed in a location that does not meet the installation conditions.
- The sensor may not work correctly if it is not installed as per the instructions in this manual.
- Pedestrians, bicycles, or any large object entering the detection area may be detected.
- Detection may fail or be intermittent depending on a vehicle size.
- Depending on the position and/or direction of vehicle approach, the distance to be detected may become shorter or may not be detected.
- Performance of the sensor may be affected if :
  - The sensor pole is not vertical from the ground
  - The sensor surface is covered with ice, snow, or dirt.
  - Heavy snowing conditions

## 3-4 Installation Workflow

Shown below is the sensor installation workflow. Please read carefully before installation.

### [1] Checking Installation Location: Go to P.5

Verify that the installation location meets the installation conditions.

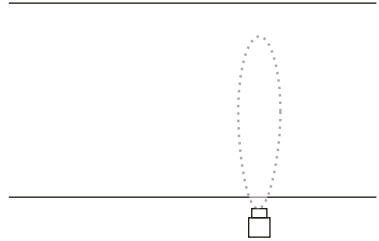

### [2] Unit Installation: Go to P.10

Remove the front cover and sensor unit, and attach the sensor and connect the wire.

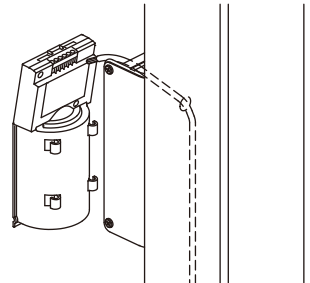

### [3] Setting Verification and Modification (if needed): Go to P.13

Check the settings, and if necessary, change them based on the installation environment and applications.

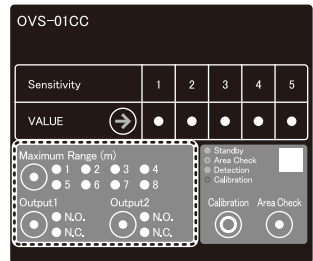

### [4] Calibration: Go to P.14

Pressing the button automatically adjusts the sensor to the installation environment.

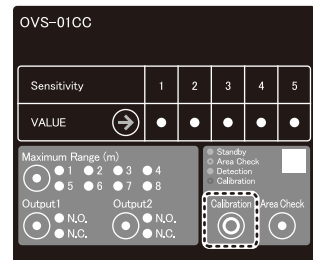



[5] Detection Area Check: Go to P.15

Verify the detection area. If needed, change the installation angle of the unit and/or sensing distance setting.

\* Once the installation condition such as the angle is modified, perform the calibration again.

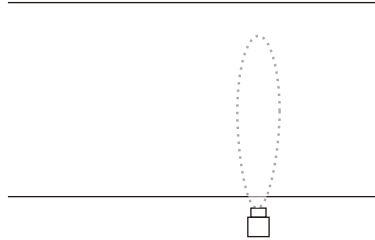
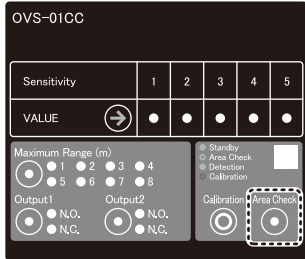

[6] System Operation Check: Go to P.16

Check the whole system operation that is connected to the sensor.

[7] Detailed Setting adjustment (if needed): Go to P.18

Change the parameter of settings if necessary after the system operation check.

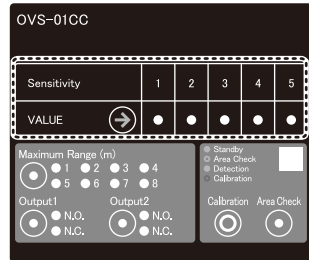

[8] Attaching Front Cover: Go to P.12

Attach the front cover, and the installation is complete.

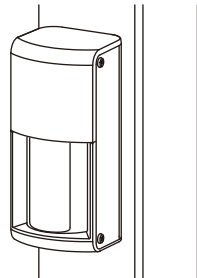

**NOTE**

**Maintenance Cleaning**

If the unit becomes dirty, lightly wipe sensor with a soft brush or cloth.  
If not cleaned yet, use a neutral detergent to clean the sensor.



- Do not use chemicals such as alcohol.
- Do not apply high-pressure water. It may result in a failure or fire.

# 4 Installation Steps (Basic)

## 4-1 Installation of the Unit

### ■ Required Tools ■

● Precision screwdriver, Phillips #1

● Screwdriver, Phillips #2

[1] Drill pilot holes into the poles and attach the sensor.

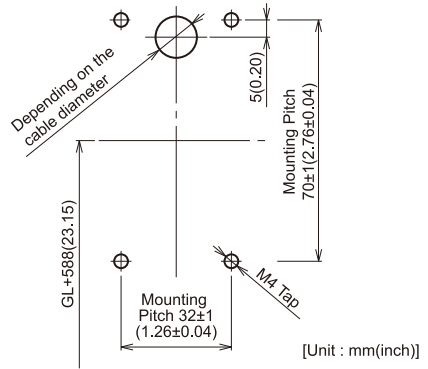

[2] Run the wire through the poles.

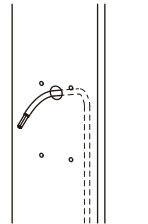

[3] Fix the poles so that the sensor faces the angle shown below.

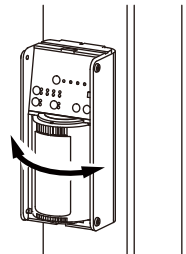
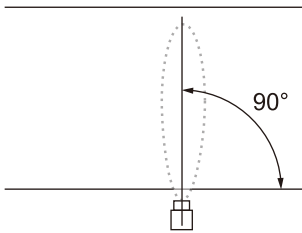

For fine angle adjustment after fixing to the poles, rotate the sensor unit to the correct angle. The sensor angle is adjustable up to 30 degrees to the left and right by 5 degree increments.

[4] Loosen the retaining screws on the bottom of the front cover and remove the front cover.

\* Do not loosen the screw completely. The screw may fall out.

If losing the screw, use a M3 x 10 philips screw.

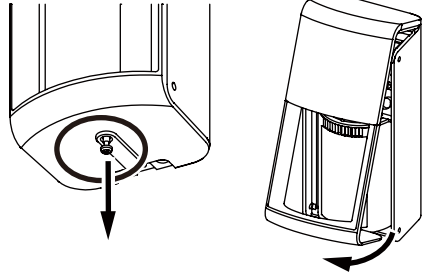

[5] Detach the sensor unit.

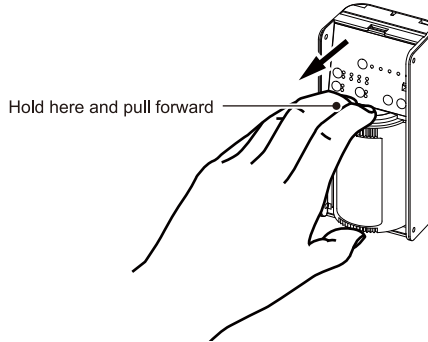

[6] Fix the base to the pole.

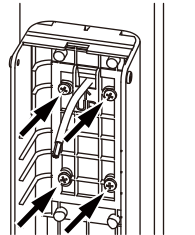

[7] Connect the wire to the terminal.

Attach the relay output wire to "Output" terminal.

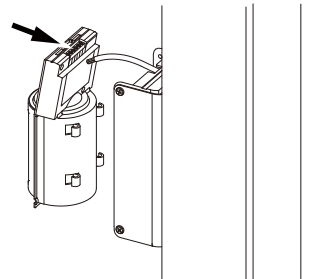
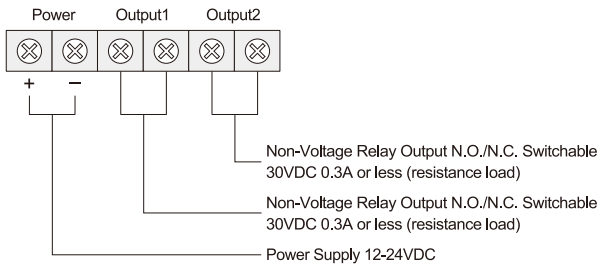

Applicable Wire

Solid wire: 0.5-1.2mm (AWG 30-16)

Stranded wire: 0.3-2.0sq (AWG 22-14)

[8] Attach the sensor unit to the base.

Press the excess wire back into to the pole while attaching the unit.

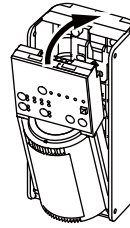

[9] Perform the steps in P.13 through 16 "4-2 Setting Verification and Adjustment", "4-3 Calibration", and "4-4 Detection Area Check".

[10] Put the front cover on the top of the base first, and attach it while spreading it open and pushing down the front cover.

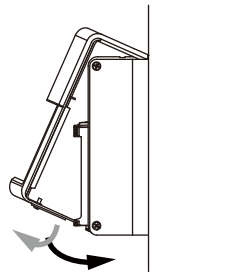
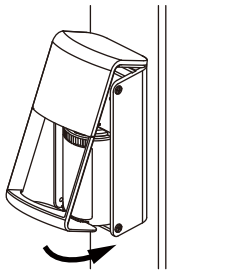

Attach the front cover while spreading it open and pushing down the bottom of the cover.

[11] Tighten the front cover retaining screw.

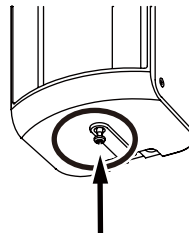

## 4-2 Setting Verification and Adjustment

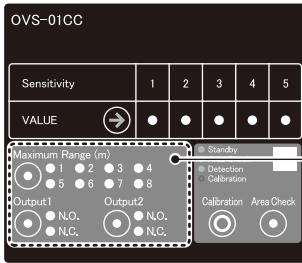

This section describes how to verify the basic settings. Use the buttons to change the settings if needed.

Basic Setting Items

### [1] Maximum Range

It is possible to adjust the detection range based on the lane width and position to detect. Pressing the Maximum Range button switches between range settings.

Factory default setting:  
3m(10ft.)

### NOTE

Recommended to set the range 1m(3.3ft.) shorter than the actual width of the road.

Maximum Range Button

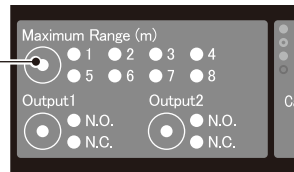

### [2] Output1

It is possible to select the output1 terminal type from N.O. (make contact) and N.C. (break contact). Pressing the Output1 button switches between [N.O.] and [N.C.].

Factory default setting:  
N.O.

Output1 Button

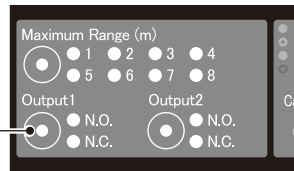

### [3] Output2

It is possible to select the output2 terminal type from N.O. (make contact) and N.C. (break contact). Pressing the Output2 button switches between [N.O.] and [N.C.].

Factory default setting:  
N.O.

Output2 Button

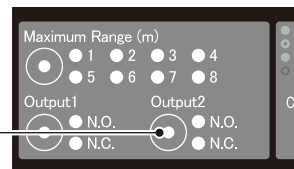

## 4-3 Calibration

### • Calibration function

This function records (memorizes) the background of the detection area without any pedestrians or vehicle present.

This process makes the sensor detection capability higher and provides stable detection.

If any noticeable changes occur around the detection area (such as construction of a wall or fence), you must perform the calibration again.

### NOTE

For normal sensor operation, the calibration must be correctly performed.

The following instructions must be observed.

- Perform this after sensor installation.
- It must be performed without vehicle, pedestrians or any other moving objects in the detection area.
- If a vehicle or pedestrian enters the detection area during the calibration, perform the calibration again.
- If changes are made to the sensor installation height, direction, and/or Maximum Range after the calibration, the calibration has to be performed again.



### • How to Perform Calibration

[1] Verify that within the detection area there is no vehicle, pedestrian, or objects. If anything is present remove them out of the detection area.

[2] Press and hold the Calibration button on the sensor unit for 2 seconds and verify that the operation indicator is blinking blue slowly.

The operation indicator blinks for 10 seconds and blinks more quickly for 2 seconds.

The first 10 seconds are preparation of calibration. You must keep the detection area vacant during this period.

The calibration is performed during the 2 seconds quick blinking period.

If a vehicle or pedestrian enter the detection area during calibration, perform the calibration again.

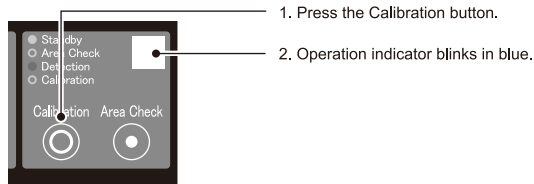

1. Press the Calibration button.

2. Operation indicator blinks in blue.

It may take more than 2 seconds for the calibration if the sensor detected a moving object during the calibration.

If the calibration does not complete, check if there is any pedestrian or moving object (e.g. flag, banner, tall weed) around the detection area. Remove it, and calibrate again.

[3] When the calibration is complete, the operation indicator turns to a solid green.

### • Cancelling Calibration

To cancel calibration, press and hold the Calibration button for 2 seconds again while the operation indicator is slowly blinking for 10 seconds. (The operation indicator turns to a solid green)

It is not possible to cancel it while the indicator is blinking quickly. Perform the calibration again.

## 4-4 Detection Area Check

- Detection Area Check Function

This function allows you to visually check the detection area of the microwave signal using the operation indicator. It is possible to verify the correct angle and size of the detection area.

\*This detection area check must be performed after calibration.

- How to Check Detection Area

[1] Pressing the Area Check button switches to the Detection Area Check Mode and the operation indicator blinks green. (If it keeps blinking green (no detection) for more than 30 seconds, it will automatically change back to the Normal Operation Mode.)

If there is a pedestrian or an object in the detection area, the operation indicator will blink red.

In this instance, remove the object to outside of the area until the indicator blinks green.

If the operation indicator is blinking red, while there is no pedestrian or object in the detection area, it is recommend that recalibration is performed.

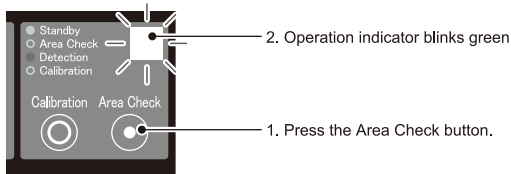

If there is a pedestrian or an object in the detection area.

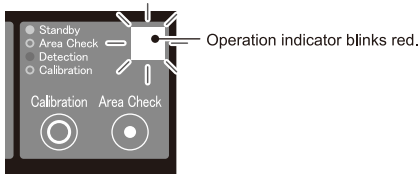

[2] Stand at the center of the vehicle lane (see Figure [A]) and walk in the direction of vehicle access.

When the operation indicator turns from green blinking (non-detection) to red blinking (detecting), it is the edge of the detection area. (Under the normal operation mode, the detection area by vehicle may be smaller)

If the detection area is not as expected, adjust the sensor angle and/or range again.

\*After the adjustment, perform calibration again.

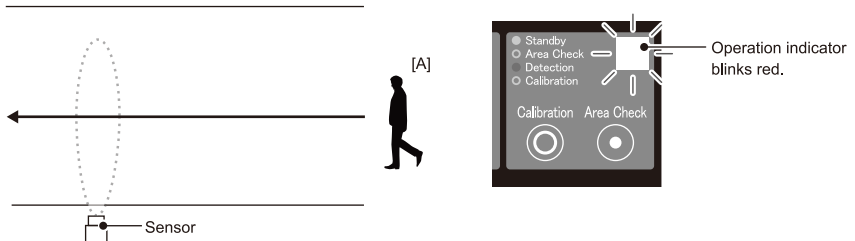

- [3] Stand at the edge of the vehicle lane (see Figure [B]), walk along the border and verify that the operation indicator keeps blinking green (not detecting).  
 If the operation indicator changes to blinking red (detecting), adjust the sensor angle and/or range setting again. After the adjustment, perform calibration again and start from step [2].

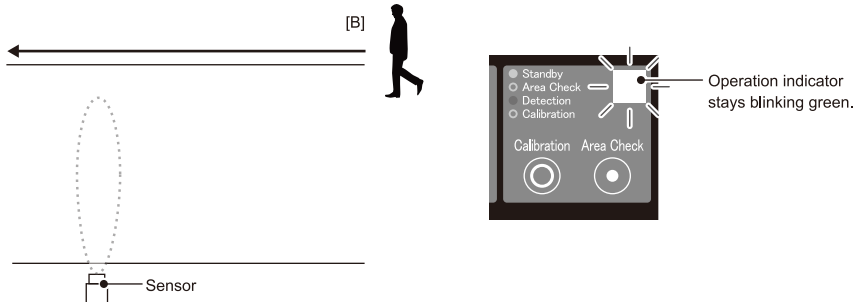

- [4] After verifying the detection area, press the Area Check button again.  
 It switches the mode back to Normal Operation Mode and the operation indicator turns a solid green.  
 \*If it keeps blinking green (no detection) for more than 30 seconds, it will automatically change back to the Normal Operation Mode.

### ■ System Operation Check

After verifying the detection area, check the entire operation system using a vehicle.  
 For the operation check, verify the proper operation with a vehicle on the left side, center, and right side of the lane.

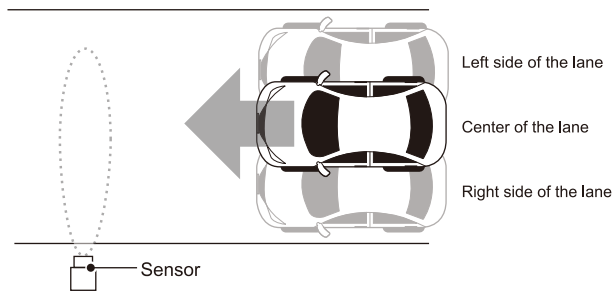



## 4-5 Other Functions

- Automatic Indicator OFF

If a button is not pressed for 30 minutes, the operation indicator dims and other indicators turn off. Pressing any button turns the indicators back on.

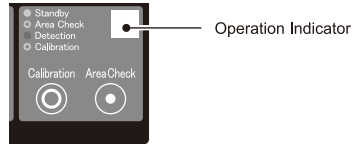

- Heater

To minimize some influence of frost and snow, the sensor unit has a built-in heater. The heater is automatically activated when the external temperature drops below 5°C (41F) or less. (The heater is automatically deactivated when the external temperature reaches 5°C (41F) or higher)

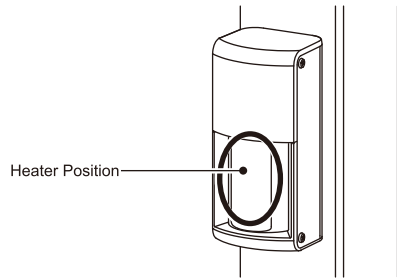

- Unsuitable environmental notification

In rare cases presence of a large metal object (i.e. a shutter) in the front of the sensor, the microwave performance may be affected and the sensor operation may become unstable.

In this particular instance, the operation indicator will be blinking green to inform you of an unsuitable environment.

When the indicator blinks in green, check if there is a large metal object in front of the sensor, and place it as far as possible from the sensor.

\* Even if the indicator light blinks green, it does not systematically signify that the sensor is operating in an unstable way.

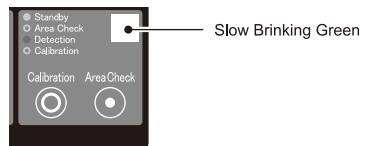

- Sensor Reset

It is possible to reset all of the settings including calibration to the factory setting. If the sensor is relocated, reset it.

To reset the sensor, press and hold both the Calibration and Area Check buttons at the same time for 2 seconds. When the reset process is completed, the operation indicator turns a solid yellow for 2 seconds.

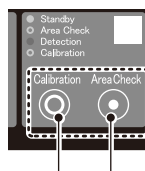

Press and hold both the Calibration button and Area Check button at the same time for 2 seconds.

# 5 Advanced Installation

The following setting parameters are to be configured if the sensor does not operate as expected in the system operation check or some error occurred. They are not necessary for a normal installation.

## 5-1 Sensitivity

Sensitivity setting, vehicle detection capability, and human cancellation capability have the following relationship. In normal cases, use with the sensitivity level of 3.

Factory default setting:  
3

Sensitivity	1	2	3	4	5
Vehicle Detection Capability	Low		High		
Human cancellation Capability	High			Low	

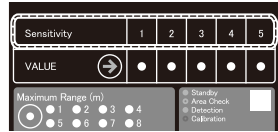

Setting change may be needed if:

- Increase..... Sometimes a vehicle is not detected  
Detection response is too slow
- Decrease..... The sensor detects a pedestrian  
The sensor detects a vehicle passing close to (but not in) the detection area  
Reverting back to non-detection status will take more time.

### ● How to Change Sensitivity Setting

Press the value button and select the desired sensitivity of the setting indicator (green). Keep pressing the button until the desired setting is reached. The sensitivity setting switches from 1 to 2, 3, 4, 5, and then returns to 1, 2, and so on. (e.g.: If the sensitivity is 3, three indicators are turned on).

Press the value button to select the sensitivity.

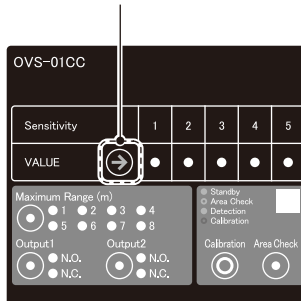

## 6 Troubleshooting

Symptom	Cause	Action
Operation indicator does not turn ON.	Power may not be supplied.	Connect power supply of 12-24VDC.
	The supply voltage may not be correct.	Check power supply voltage 12-24VDC.
	The power supply polarity is wrong (wrong polarity does not cause a failure but the product does not work).	Check power supply polarity. Confirm that DC power is being supplied instead of AC.
All LED indicators are blinking continuously. Sensor detection is not conveyed to a system device.	AC power is supplied to the power input.	Correct to a DC power supply.
	The relay output wiring may not be correct. Output contact type is incorrect.	Check wiring connection is correct. Select the correct output contact type for the system device.
Calibration does not end.	There may be a moving object in detection area.	Remove the pedestrian or moving object (e.g. flag, banner, weeds) in front of the sensor.
A vehicle moving the detection area is occasionally or never detected.	Power may not be supplied.	Connect power supply of 12-24VDC.
	The supply voltage maybe incorrect.	Check power supply voltage 12-24VDC.
	Calibration may not have been performed correctly.	Perform calibration correctly.
	The direction of the sensor (detection area) is not correct.	Adjust the sensor (detection area) direction for correct detection.
	The sensor may be affected by the background.	Perform calibration again.
	The sensing distance may be too short.	Increase the sensing distance.
	Sensitivity may be too low.	Enhance sensitivity.
The sensor does not revert back to non detection status when a vehicle leaves the detection area, or takes longer to change status.	Vehicle's passing speed is too high (too low)	A vehicle can be detected at a velocity of 2 to 60kph(1.24 to 37.28mph) when entering the detection area.
	There may be a human, bicycle, large package, weed, or snow.	Remove the object causing the problem. If it cannot be removed, reduce the sensing distance.
	There may be an object on the sensor surface such as chewing gum.	Remove the object.
	Calibration may not have been performed correctly.	Perform calibration again.
The sensor detects a vehicle outside of the detection area.	The direction of the sensor (detection area) is not correct.	Adjust the sensor (detection area) direction to the correct detection.
	Sensitivity may be too high.	Reduce sensitivity.
	The sensing distance may be too long.	Reduce the sensing distance.
The sensor detects a pedestrian entering the sensor's detection area.	The direction of the sensor (detection area) is not correct.	Adjust the sensor (detection area) direction for correct detection.
	Sensitivity may be too high.	Reduce sensitivity.
The sensor detects a pedestrian with a large luggage or a metal object passing in the sensor's detection area.	More than one pedestrian may be entering.	The sensor sometimes detects a crowd of pedestrians .Take steps so that pedestrians should not enter the detection area.
	Sensitivity may be too high. The metal object or luggage is too large.	Reduce sensitivity. The sensor may not discriminate a large object from a vehicle. Take steps so that pedestrian should not pass the area.

If you still can't solve the problem even after following the instructions above, contact our sales representative or sales office.

# 7 Specifications

## 7-1 Specifications

Model	OVS-01CC	
Detection Method	Combination of microwave Doppler shift and FMCW technologies	
Sensor Frequency	24GHz	
Response	300msec	
Supply Voltage	12 - 24VDC	
Power Consumption	Heater enabled: Up to 190mA, Heater disabled : Up to 70mA (at 24V)	
Output	Relay output DC30V, 0.3A (N.O. / N.C. switchable)	
Microwave Sensor Sensing Distance	0.8 to 8m (2.6 to 26.3 ft.), adjustable	
Detectable Vehicle Speed	2 - 60 kph (1.2 - 37.3 mph)	
Device Setting	Sensitivity	Level 1 to 5
	Output 1 Contact Switching	N.O. / N.C.
	Output 2 Contact Switching	N.O. / N.C.
	Sensing Distance	1 / 2 / 3 / 4 / 5 / 4 / 6 / 7 / 8 m ( 3.3 / 6.6 / 9.8 / 13.1 / 16.4 / 19.7 / 23.0 / 26.3 ft.)
Indicator	Normal Operation	Standby: Solid Green, Detected: Solid Red Unsuitable environmental notification : Slow Blinking Green
	Detection Area Check	Non detection: Blinking Green, Detected: Blinking Red
	Calibration	Getting ready: Slow Blinking Blue, Calibrating: Quick Blinking Blue
	Sensor Reset	Reset Complete: Solid Yellow for 2 seconds
Human Cancellation Function	Yes	
Operating Ambient Temperature	-30 to 50°C (-22 to 122 F)	
Operating Ambient Humidity	95% max. (no condensation)	
Degree of Protection	IP65	
Installation Location	Indoor / Outdoor	
Installation Height	500mm (20in.) (distance from the ground to the bottom of the unit)	
Sensor Angle Adjustment	Left and Right: ±30 degrees (5-degree step)	
Weight	400 g (15oz)	
Accessories	Retaining screws x 4, Installation manual (this document) OVS-SGA(A) included for US model only	

Specifications are subject to change without notice for improvement.

<Notice>

Please note that we are not responsible for any damage that occurred when the equipment was operated or installed improperly.

## 7-2 Detection Area Diagram

Top View

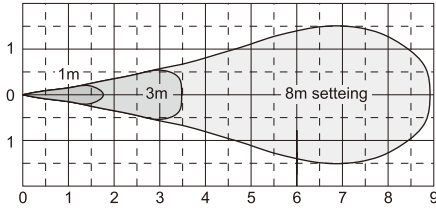

Side View

[Unit: m]  
1m=3.3ft.

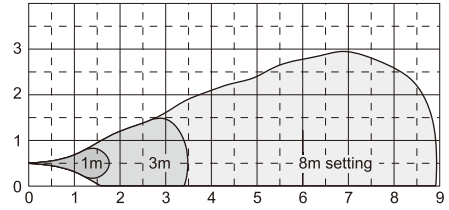

Installation height 0.5m, Sensitivity: 3, Detection area check mode

\* Under the normal operation mode, the detection area by an actual vehicle may be smaller.

## 7-3 Dimensions

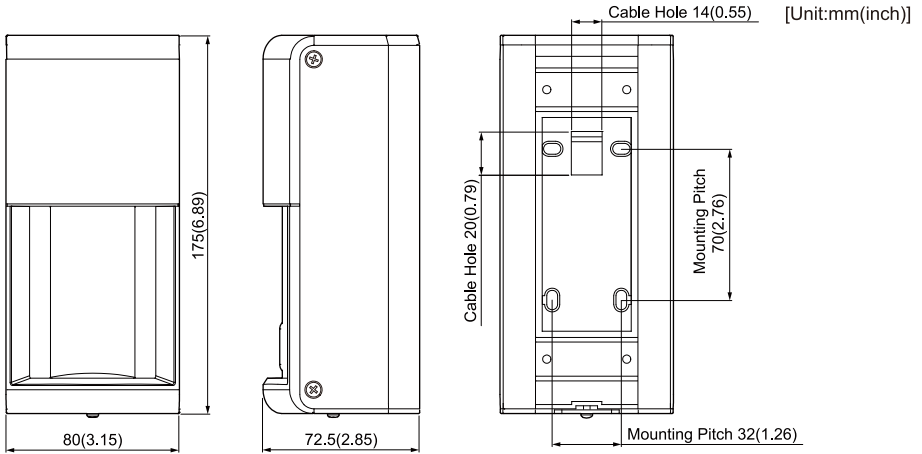

## 8 Accessory

### OVS-SGA(A)

Single gang box adaptor  
(for US size only)

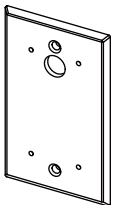

### OVS-TB01

Triangle bracket  
for 45 deg and 90 deg setting

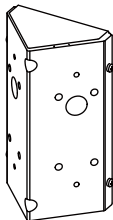

### OVS-MP

Mini post for OVS series (**US only**)  
OVS-MPB:Black  
OVS-MPY:Yellow  
OVS-MPBCURB:Black for curb  
OVS-MPYCURB:Yellow for curb

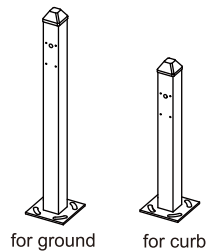

Hereby, OPTEX declares that the radio equipment type OVS-01CC is in compliance with RED 2014/53/EU. The full text of the EU DoC is available at the following internet address: [www.optex.net](http://www.optex.net)

#### EU contact information

Manufacturer:

OPTEX CO., LTD. 5-8-12 Ogoto, Otsu, Shiga, 520-0101 JAPAN

Authorised representative in Europe:

OPTEX (EUROPE) LTD. / EMEA HEADQUARTERS

Unit 13, Cordwallis Park, Clivemont Road, Maidenhead, Berkshire, SL6 7BU, U K

Microwave emission Frequency and Power: 24.05 - 24.25 GHz 30mW e.i.r.p

#### FCC NOTICE

This device complies with part 15 of the FCC Rules. Operation is subject to the following two conditions:

(1) This device may not cause harmful interference, and (2) this device must accept any interference received, including interference that may cause undesired operation.

#### FCC WARNING(For USA)

Changes or modifications not expressly approved by the party responsible for compliance could void the user's authority to operate the equipment.

#### -NOTICE-

This equipment has been tested and found to comply with the limits for a Class B digital device, pursuant to part 15 of the FCC Rules. These limits are designed to provide reasonable protection against harmful interference in a residential installation. This equipment generates, uses and can radiate radio frequency energy and, if not installed and used in accordance with the instructions, may cause harmful interference to radio communications. However, there is no guarantee that interference will not occur in a particular installation. If this equipment does cause harmful interference to radio or television reception, which can be determined by turning the equipment off and on, the user is encouraged to try to correct the interference by one or more of the following measures:

-Reorient or relocate the receiving antenna.

-Increase the separation between the equipment and receiver.

-Connect the equipment into an outlet on a circuit different from that to which the receiver is connected.

-Consult the dealer or an experienced radio/TV technician for help.

#### -NOTICE-

1.The antennas cannot be exchanged.

2.To comply with FCC RF exposure compliance requirements, a separation distance of at least 20cm must be maintained between the antenna of this device and all persons.

#### -ISED NOTICE-

This device contains licence-exempt transmitter(s)/receiver(s) that comply with Innovation, Science and Economic Development Canada's licence-exempt RSS(s). Operation is subject to the following two conditions:

1. This device may not cause interference.

2. This device must accept any interference, including interference that may cause undesired operation of the device.

This equipment complies with ISED radiation exposure limits set forth for an uncontrolled environment and meets RSS-102 of the ISED radio frequency (RF) Exposure rules. This equipment should be installed and operated keeping the radiator at least 20cm or more away from person's body.

L'émetteur/récepteur exempt de licence contenu dans le présent appareil est conforme aux CNR d'Innovation, Sciences et Développement économique Canada applicables aux appareils radio exempts de licence.

L'exploitation est autorisée aux deux conditions suivantes :

1. L'appareil ne doit pas produire de brouillage;

2. L'appareil doit accepter tout brouillage radioélectrique subi, même si le brouillage est susceptible d'en compromettre le fonctionnement.

Cet équipement est conforme aux limites d'exposition aux rayonnements énoncées pour un environnement non contrôlé et respecte les règles d'exposition aux fréquences radioélectriques (RF) CNR-102 de l'ISDE. Cet équipement doit être installé et utilisé en gardant une distance de 20 cm ou plus entre le radiateur et le corps humain.





**OPTEX CO.,LTD. (JAPAN)**  
(ISO 9001 Certified) (ISO 14001 Certified)  
5-8-12 Ogoto Otsu Shiga 520-0101 JAPAN  
TEL:+81-77-579-8670  
[www.optex.net](http://www.optex.net)

**OPTEX INC. (USA)**  
TEL:800-877-6656 (Toll free)  
FAX:+1-310-898-1098  
[www.optex-vs.com](http://www.optex-vs.com)

**OPTEX (EUROPE)LTD. (UK)**  
TEL:+44-1628-631000  
[www.optex-europe.com](http://www.optex-europe.com)

**OPTEX SECURITY SAS (FRANCE)**  
TEL:+33-437-55-50-50  
[www.optex-security.com](http://www.optex-security.com)

■ EU & UK contact information



<https://navi.optex.net/cert/contact/>

**OPTEX SECURITY Sp.zo.o. (POLAND)**  
TEL:+48-22-598-06-55  
[www.optex.com.pl](http://www.optex.com.pl)

**OPTEX KOREA CO., LTD. (KOREA)**  
TEL:+82-2-719-5971  
[www.optexkorea.com](http://www.optexkorea.com)

**OPTEX (DONGGUAN) CO., LTD.  
SHANGHAI OFFICE (CHINA)**  
TEL:+86-21-34600673  
[www.optexchina.com](http://www.optexchina.com)