

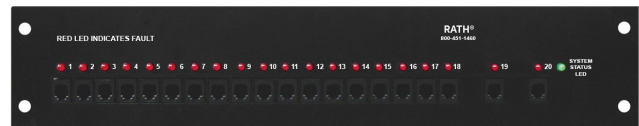

Area of Refuge/Two-Way Communication System Mounting Guide



Made in the USA
3 Year Warranty

N56W24720 N. Corporate Circle • Sussex, WI 53089
800-451-1460 • www.RATHCommunications.com



Thank you for purchasing a RATH® Emergency Communication System. We are the largest Emergency Communication Manufacturer in North America and have been in business for over 35 years.

We take great pride in our products, service, and support. Our Emergency Products are of the highest quality. Our experienced customer support teams are available to remotely assist with site preparation, installation, and maintenance. It is our sincere hope that your experience with us has and will continue to surpass your expectations.

Thank you for your business,

The RATH® Team

Table of Contents

Call Box Mounting	Page 3-8
Base Station Mounting	Page 9-14
Distribution Module Mounting	Page 15-16
Supervisor Mounting	Page 16
Signage Mounting	Page 17
System Mounting Locations	Page 18

Call Box Mounting

Call Boxes should be mounted so that the push button is 48" from the floor.

**Flush Mount Call Boxes:
2100-958NSR, 2400-808NSP, 2100-958NMBR, 2400-808NMP, SUBPNBX (back box only)**

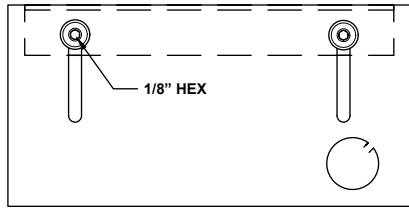

A INTERIOR ELEVATION

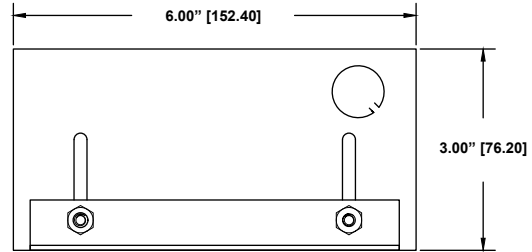

BACK BOX TOP

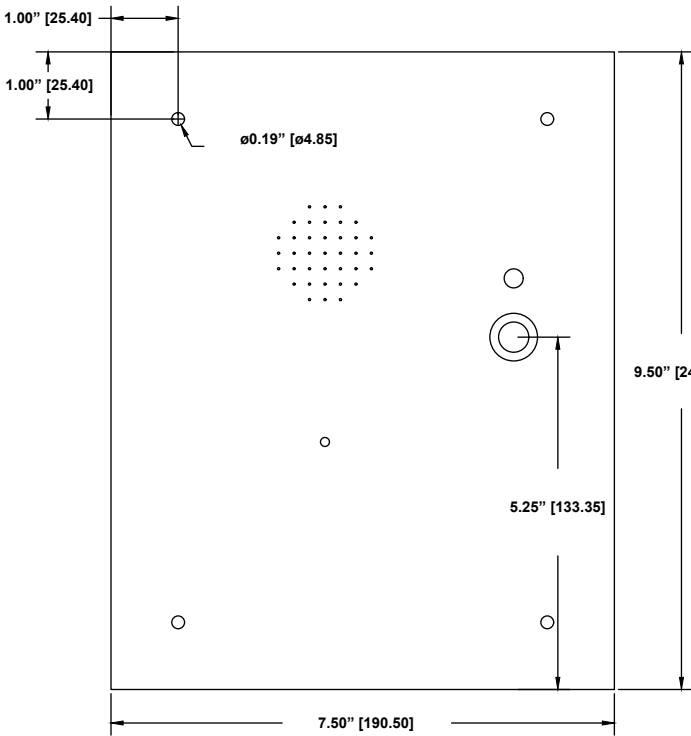

COVER FRONT

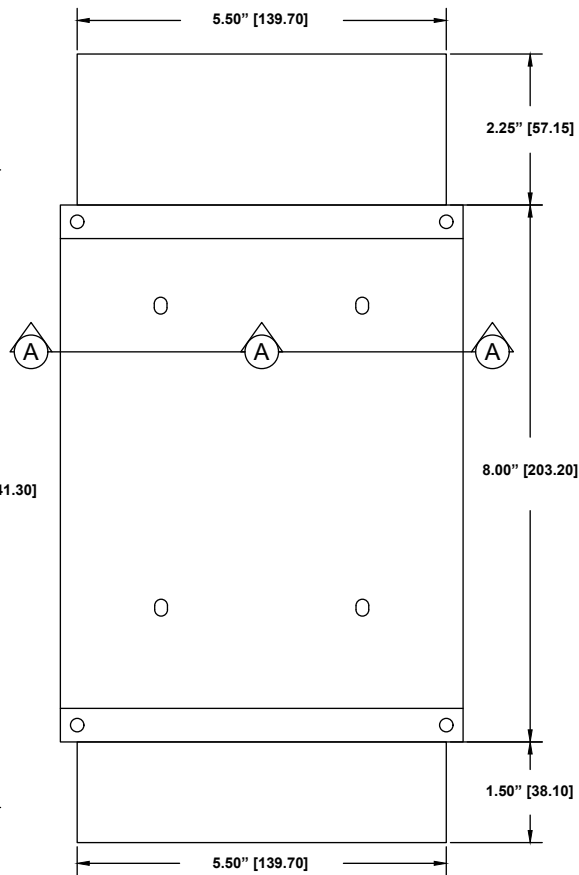

BACK BOX FRONT

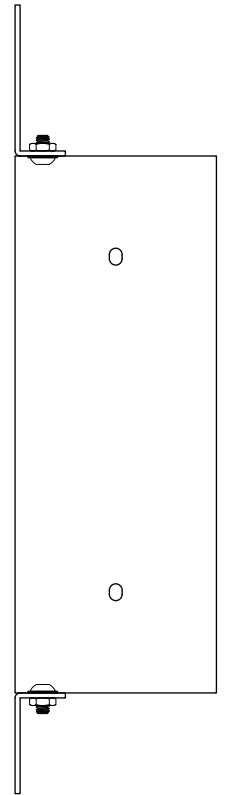

BACK BOX SIDE

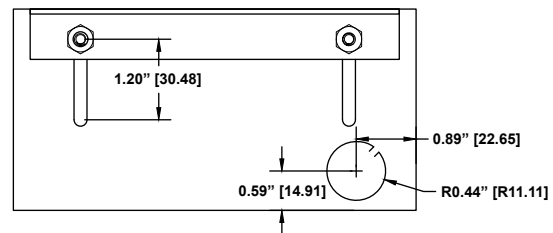

BACK BOX BOTTOM

2100-958SSRC2, 2400-808SSPC2, RP7700042PC (back box only)

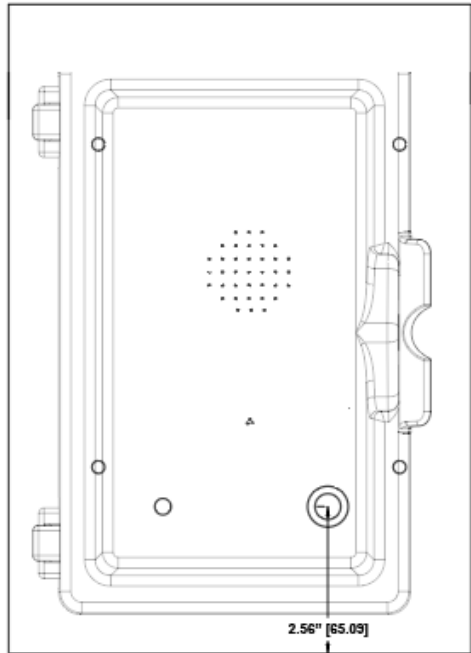

COVER FRONT

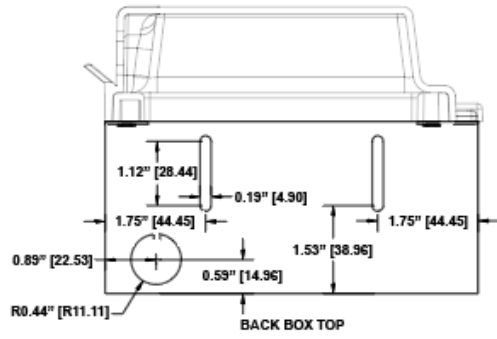

BACK BOX TOP

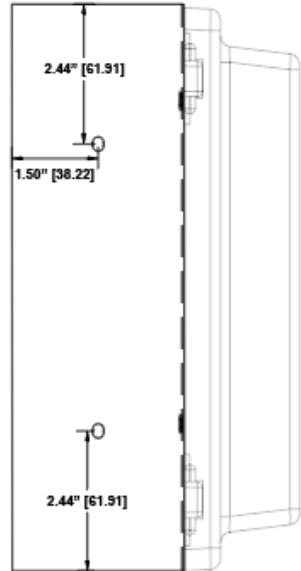

BACK BOX LEFT SIDE

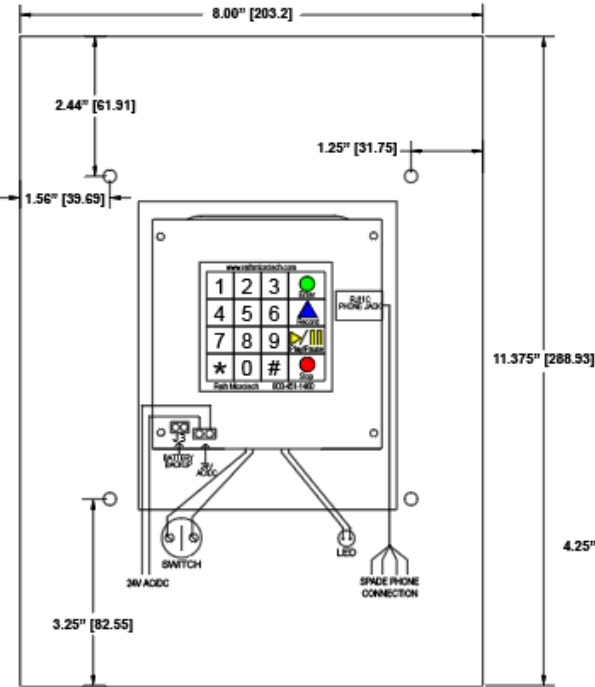

COVER BACK

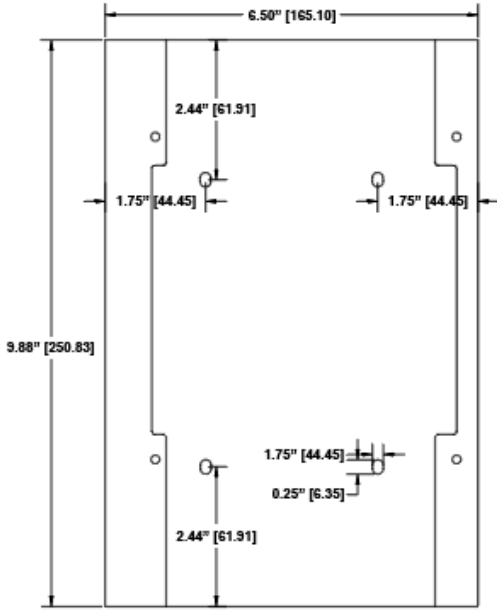

BACK BOX FRONT

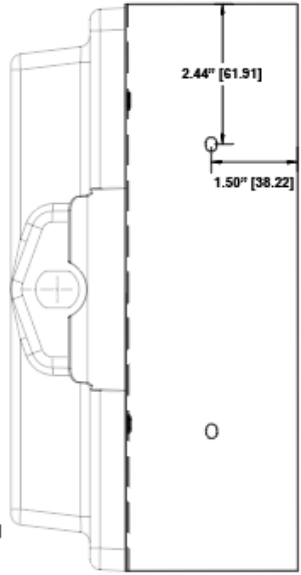

BACK BOX RIGHT SIDE

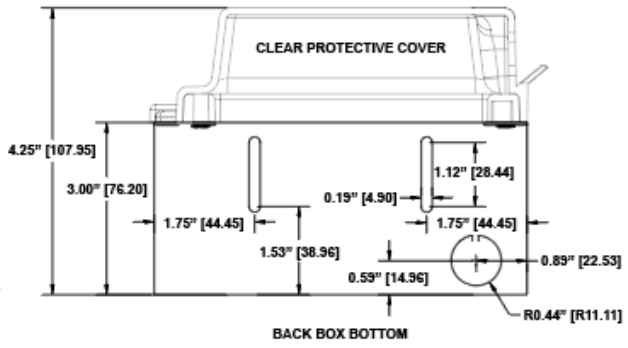

BACK BOX BOTTOM

2100-958SR, SUBPNBX (back box only)

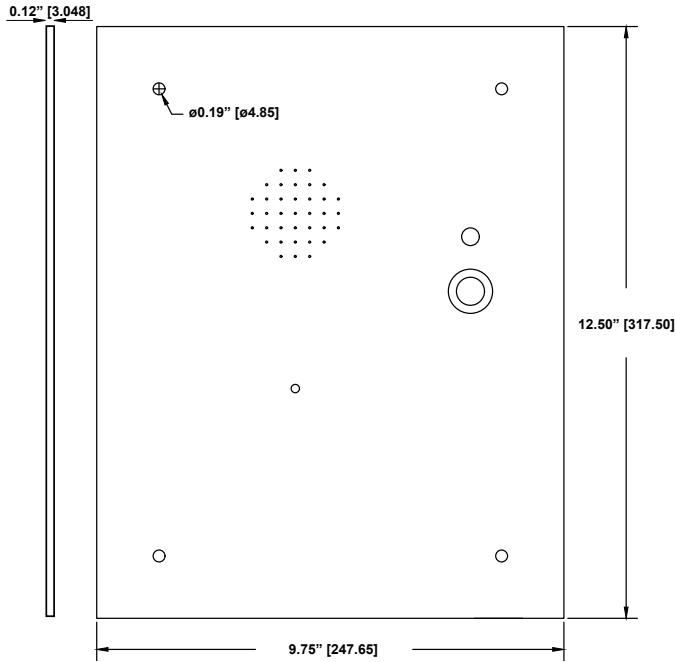

COVER FRONT

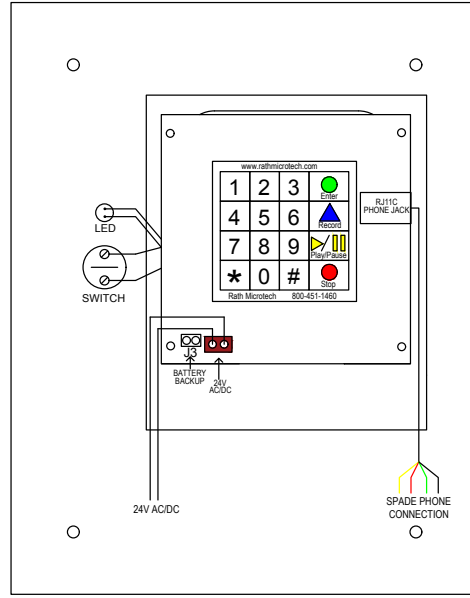

COVER REAR

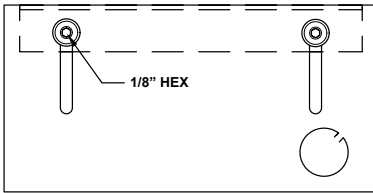

A INTERIOR ELEVATION

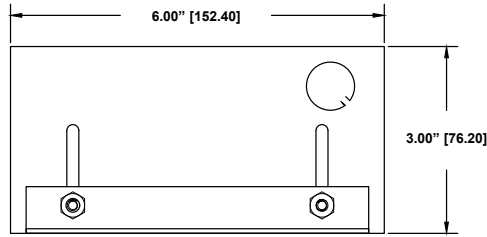

BACK BOX TOP

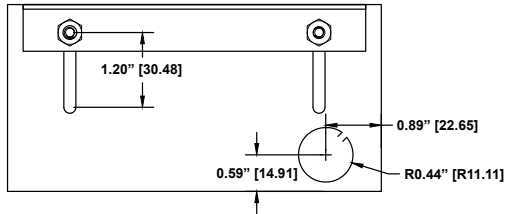

BACK BOX BOTTOM

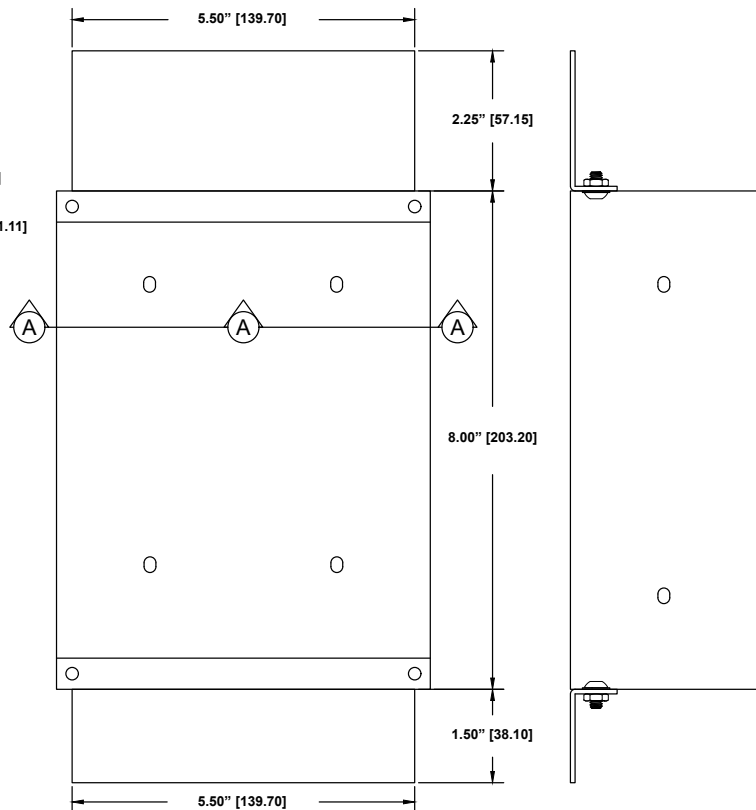

BACK BOX FRONT

BACK BOX SIDE

**Surface Mount Call Boxes:
2100-956SR, 2400-805SP, 2100-956SRM, 2400-805SPM, 2100-956RR, 2400-805RP**

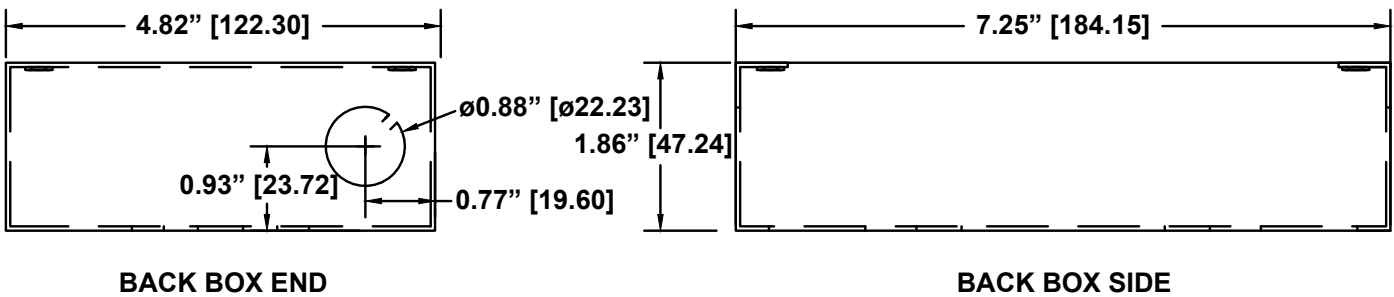
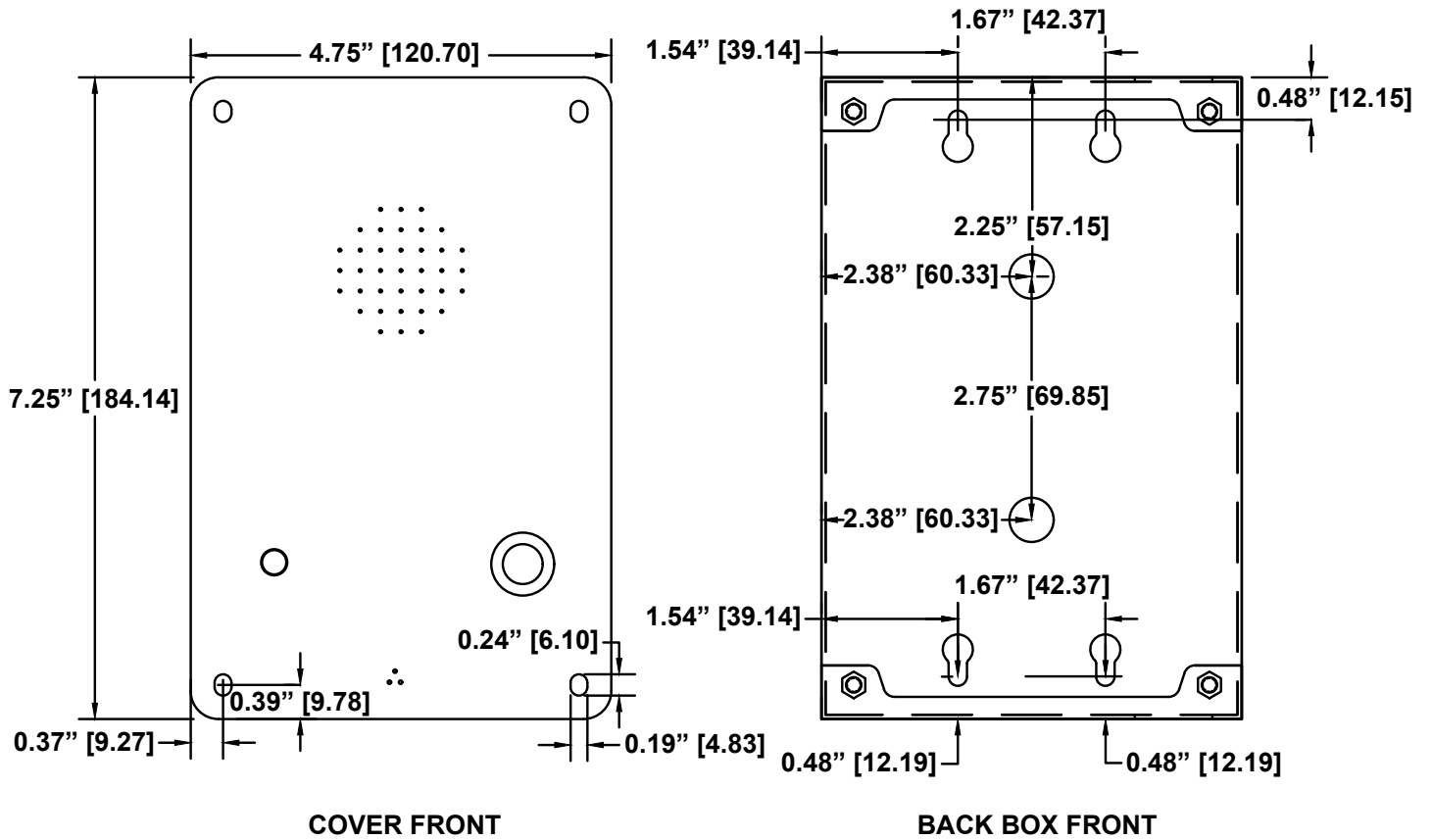

2100-984LR, 2400-805LP, 2100-984LRC1, 2400-805LPC1

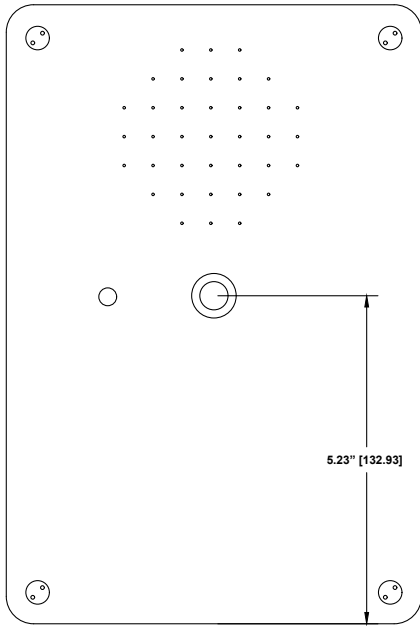

COVER OUTSIDE

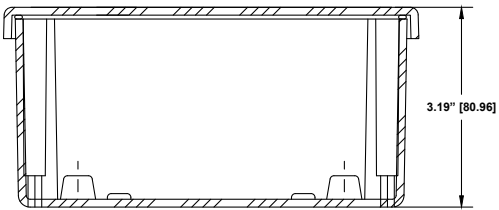

BOTTOM

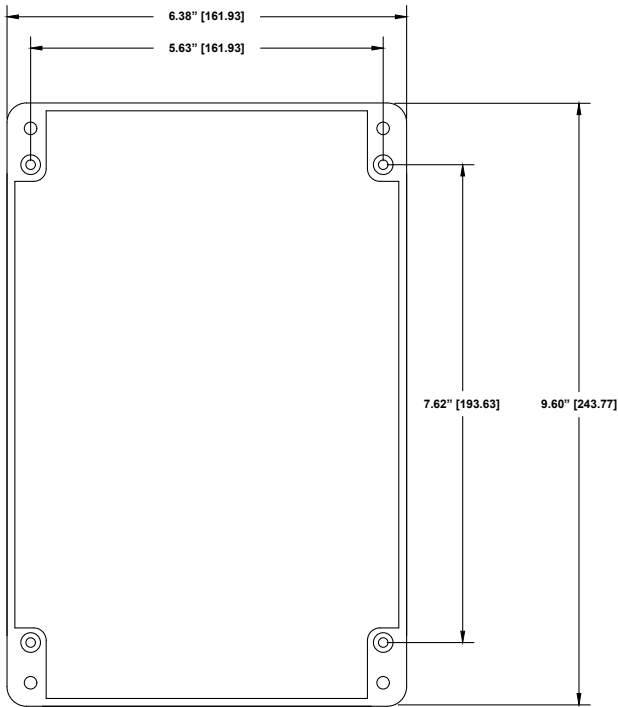

BASE INSIDE

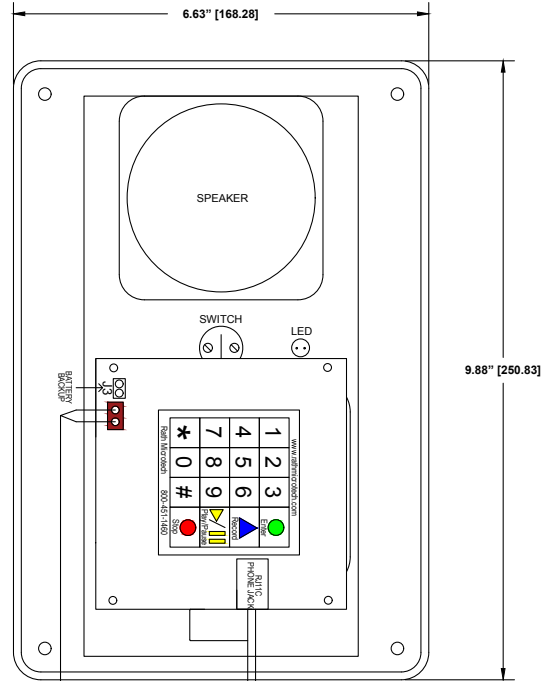

COVER INSIDE

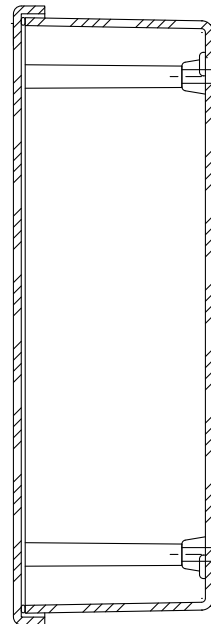
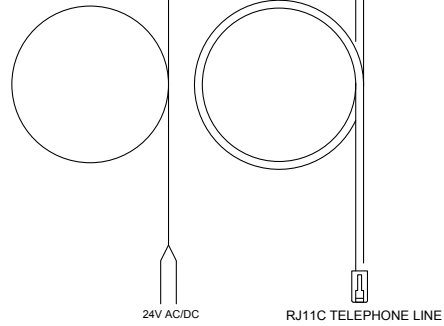

SIDE

2100-956SSRC2, 2400-805SSPC2

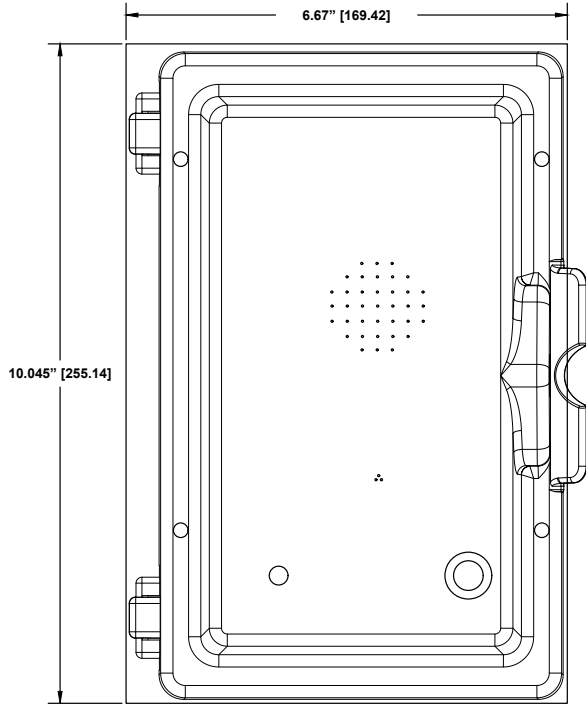

COVER FRONT

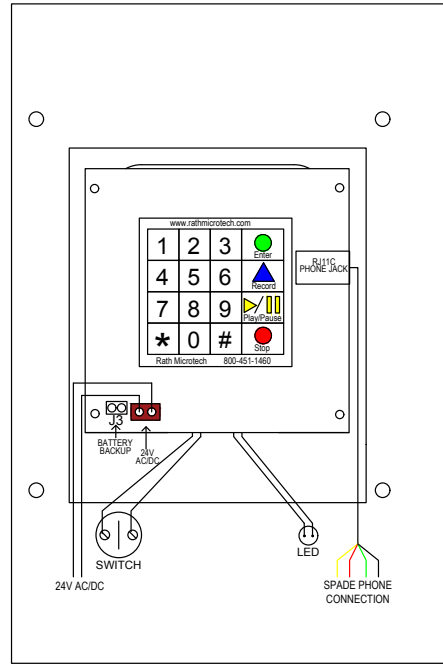

BACK

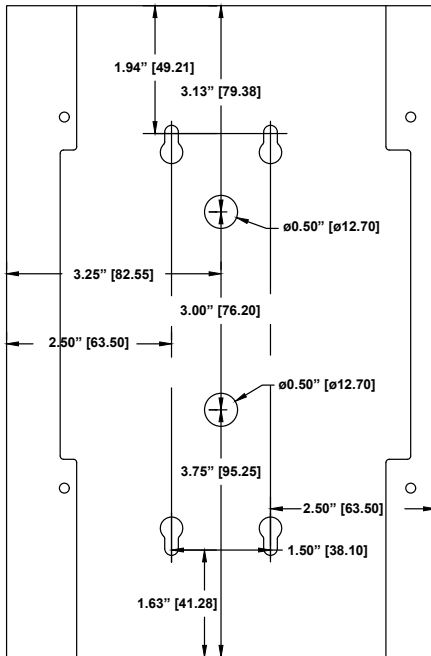

BACK BOX FRONT

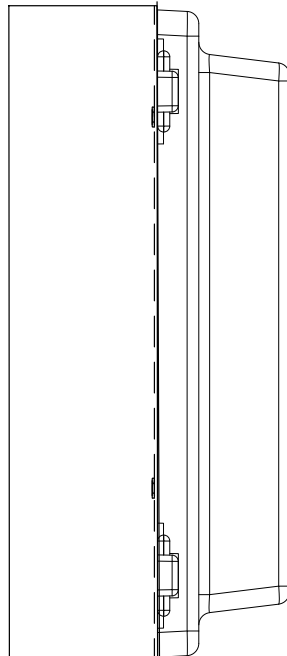

BACK BOX LEFT SIDE

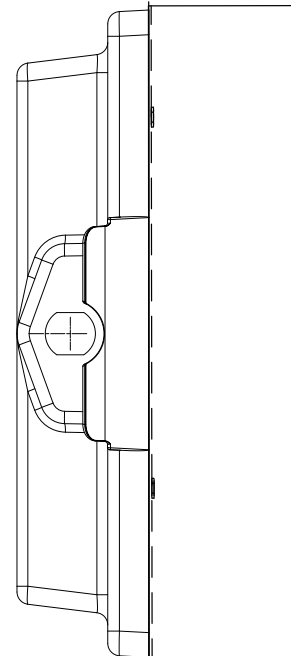

BACK BOX RIGHT SIDE

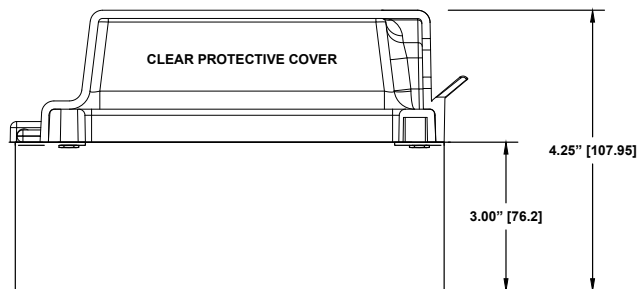

BACK BOX BOTTOM

Base Station Mounting

RATH® recommends mounting the Base Station 60" from the floor to the center of the unit.

2500-205D, 2500-210D

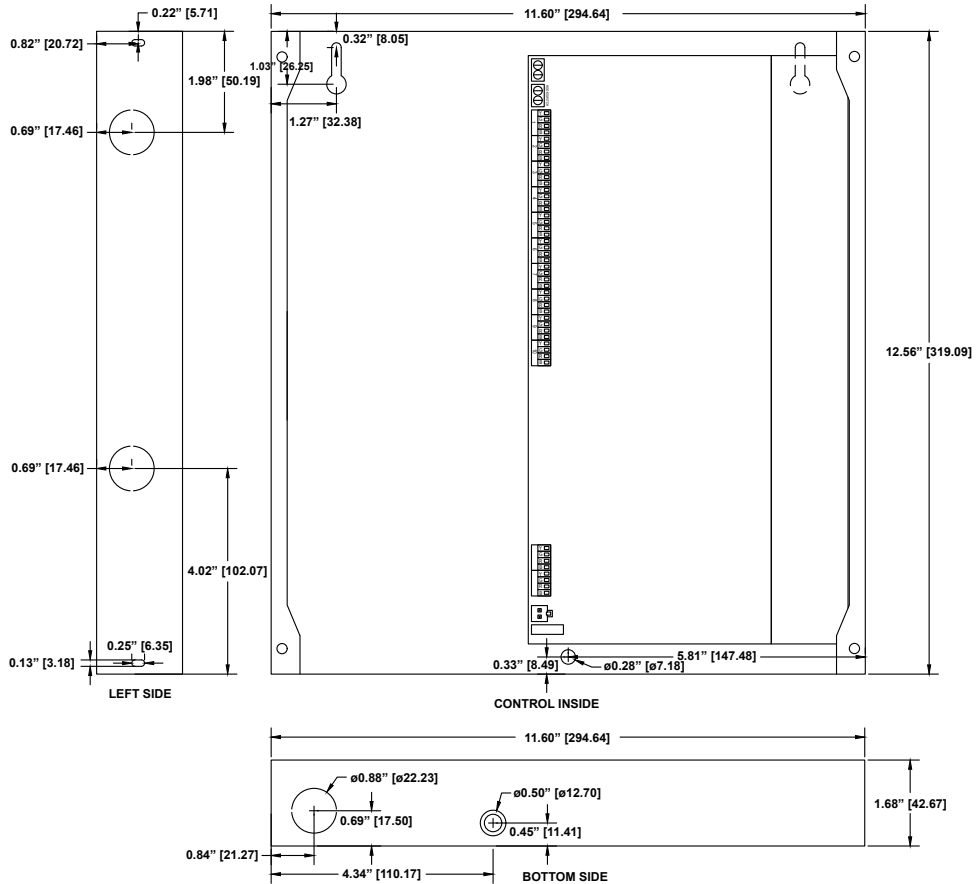
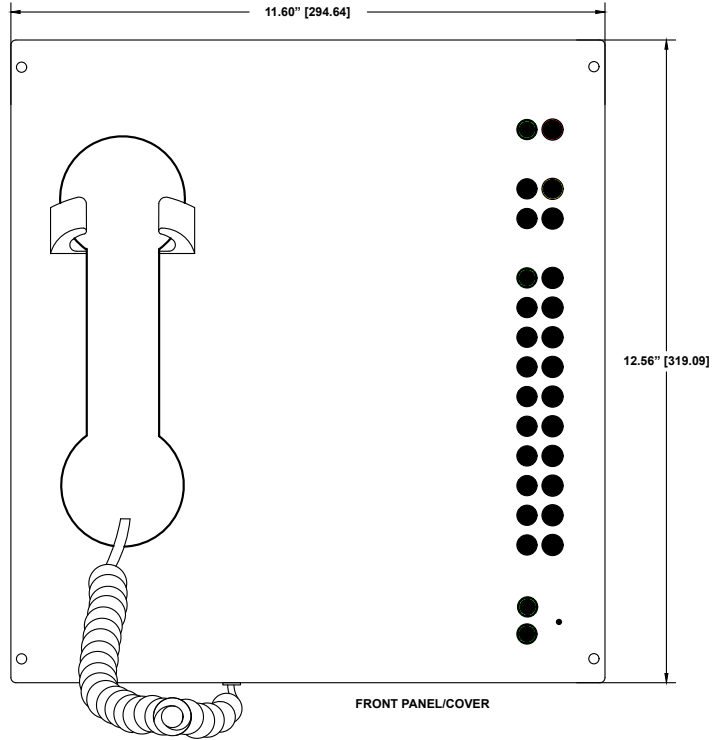

2500-205PSS, 2500-210PSS

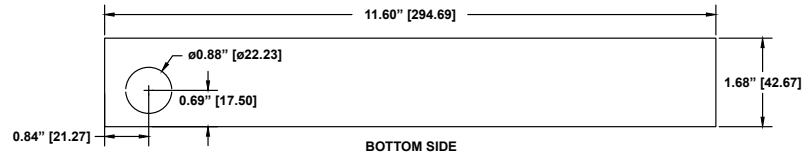
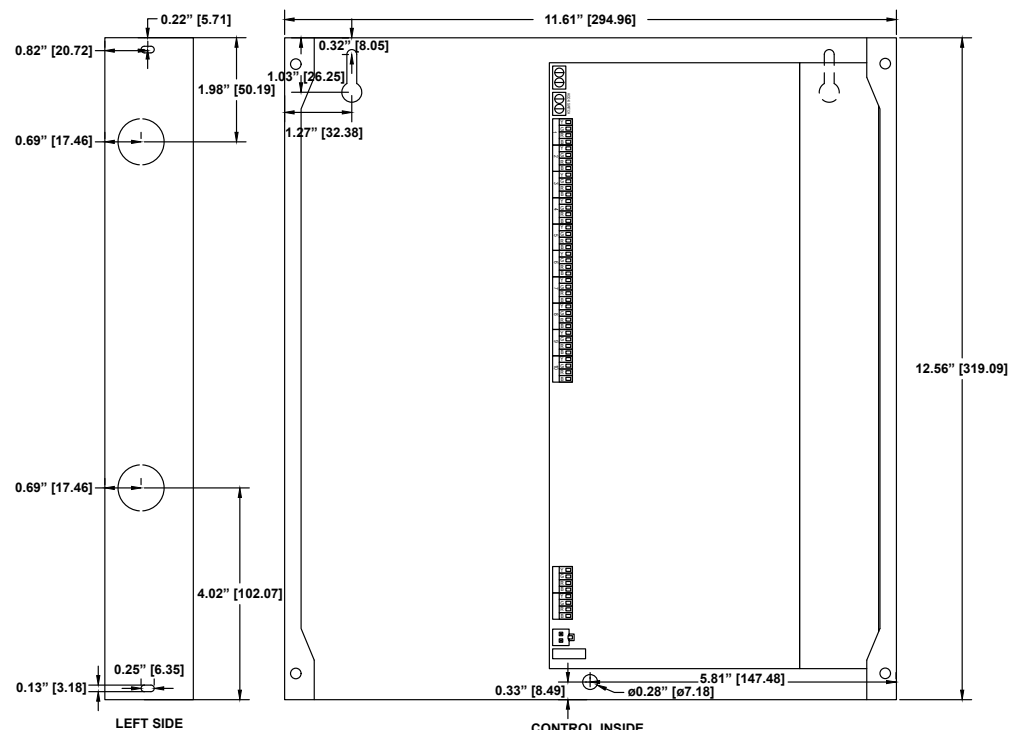
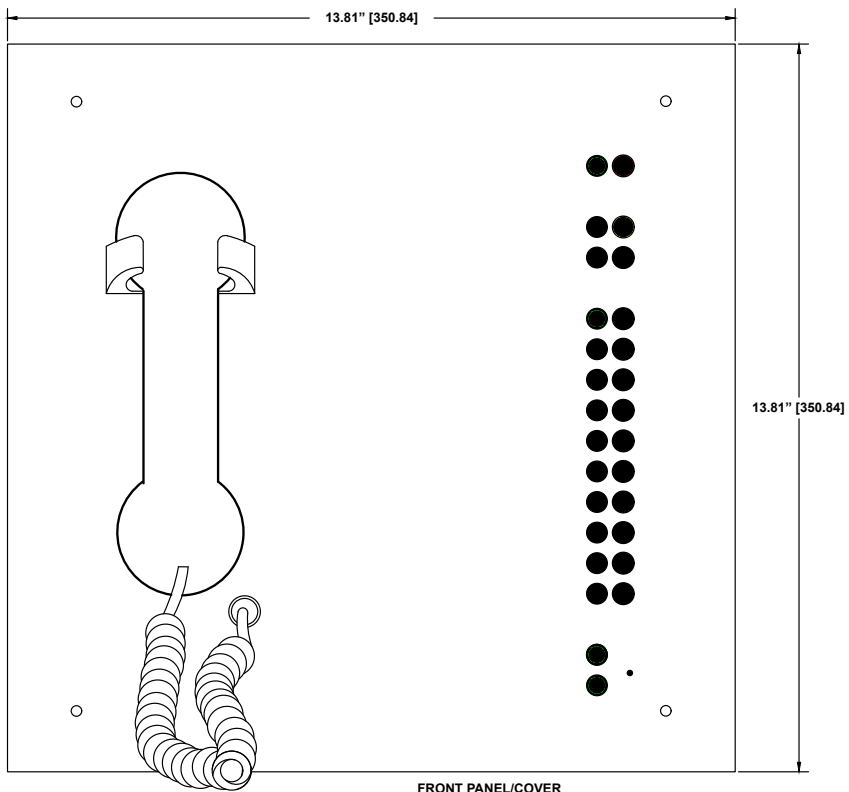

2500-205B, 2500-210B, 2500-12RC, 2500-16RC

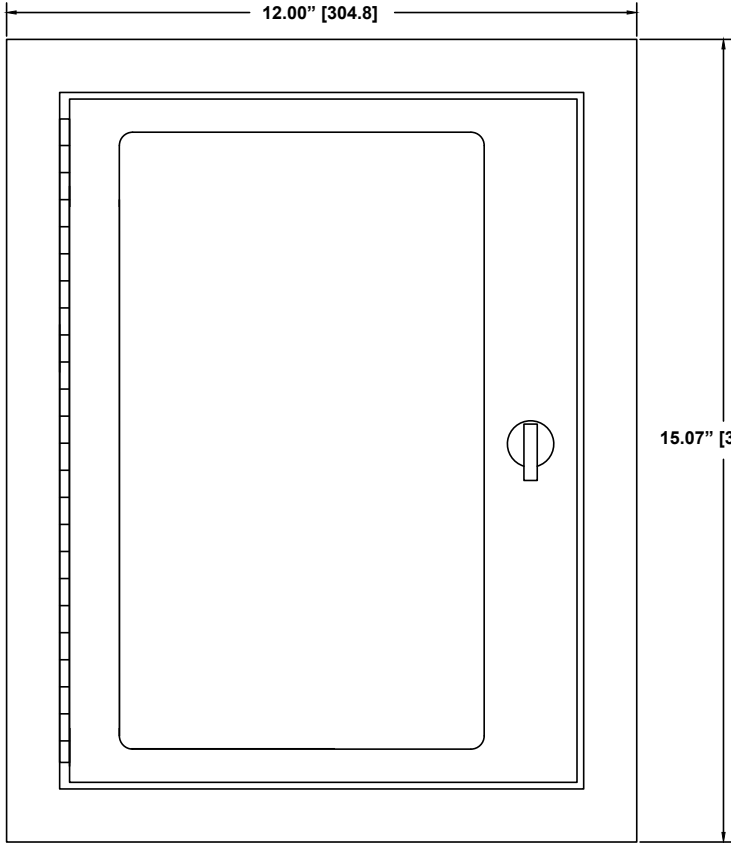

FRONT VIEW

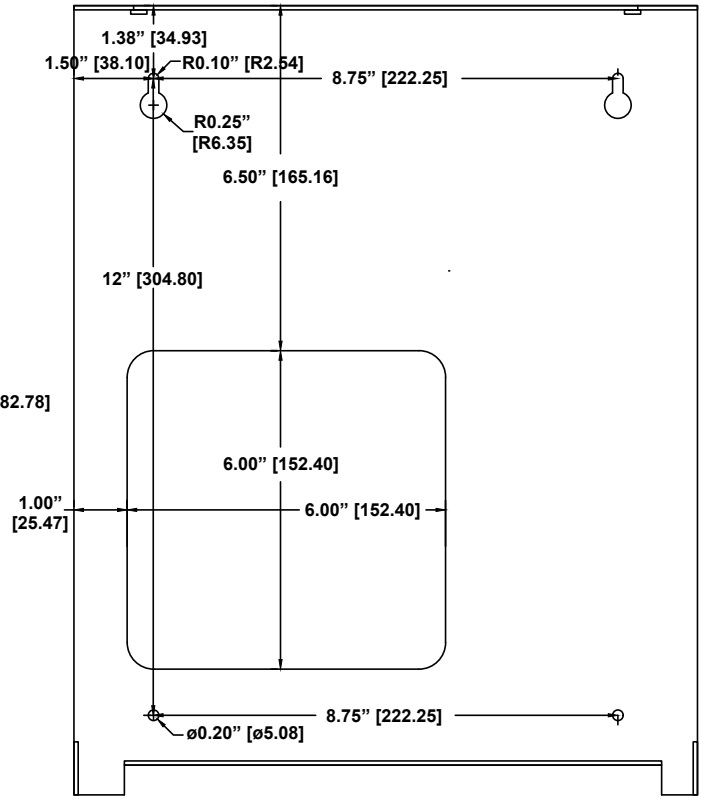

BACK PANEL



BOTTOM VIEW

2500-205FM, 2500-210FM, 2500-12RCF, 2500-16RCF

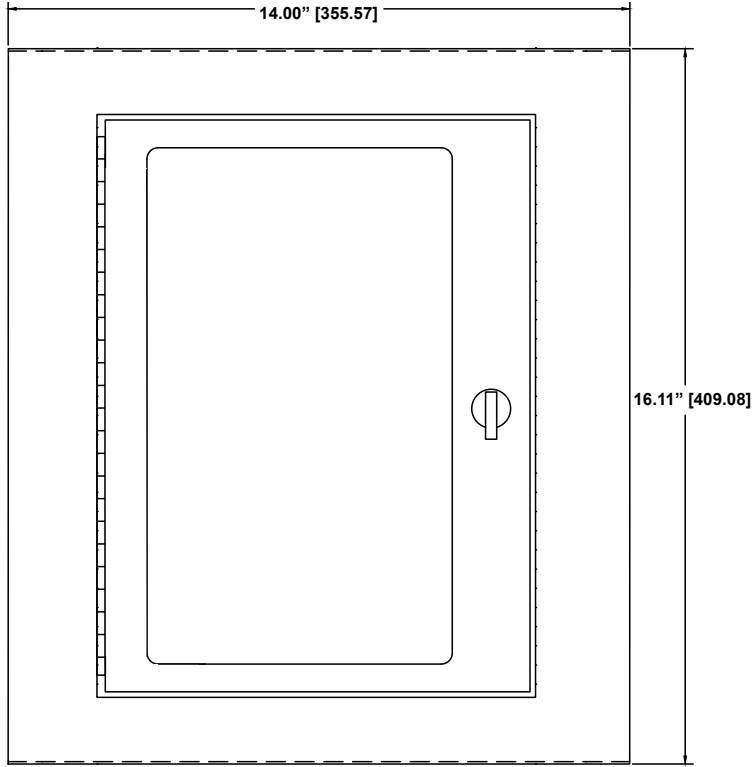

FRONT VIEW

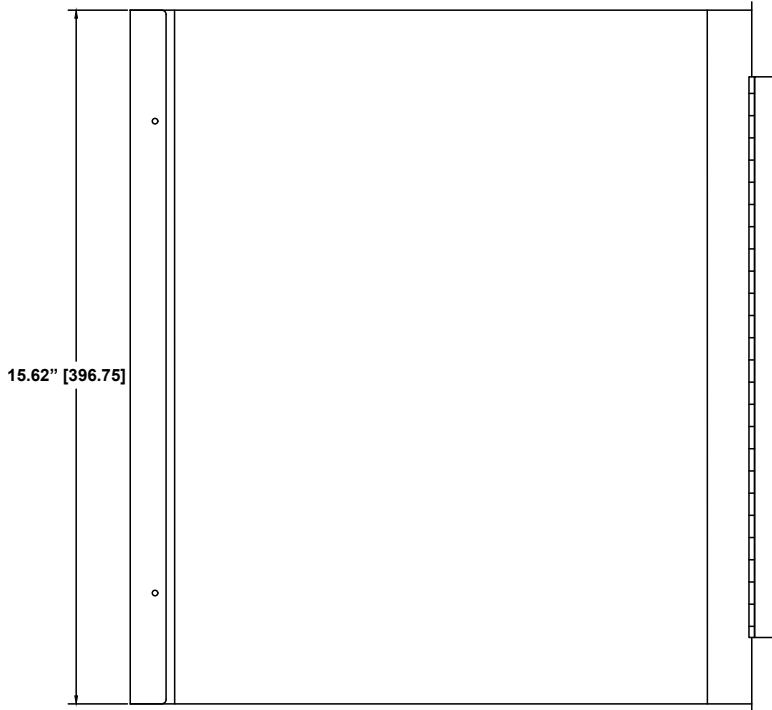

INSIDE VIEW WITH FRONT PANEL OPENED

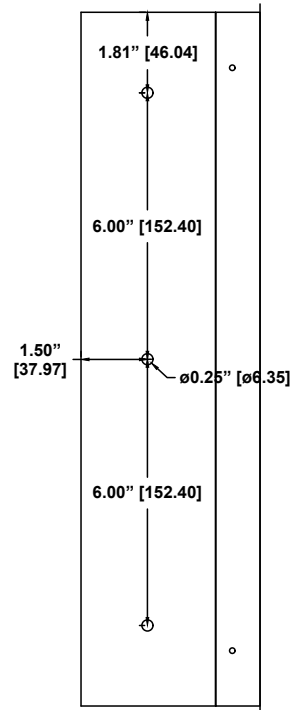

SIDE VIEW

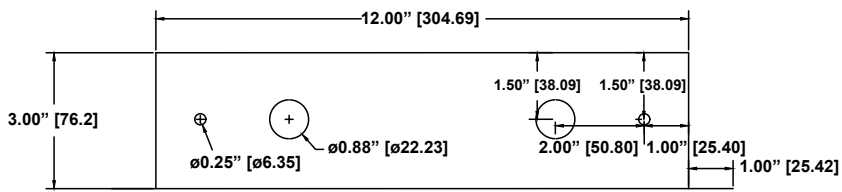

CABINET BACK BOX

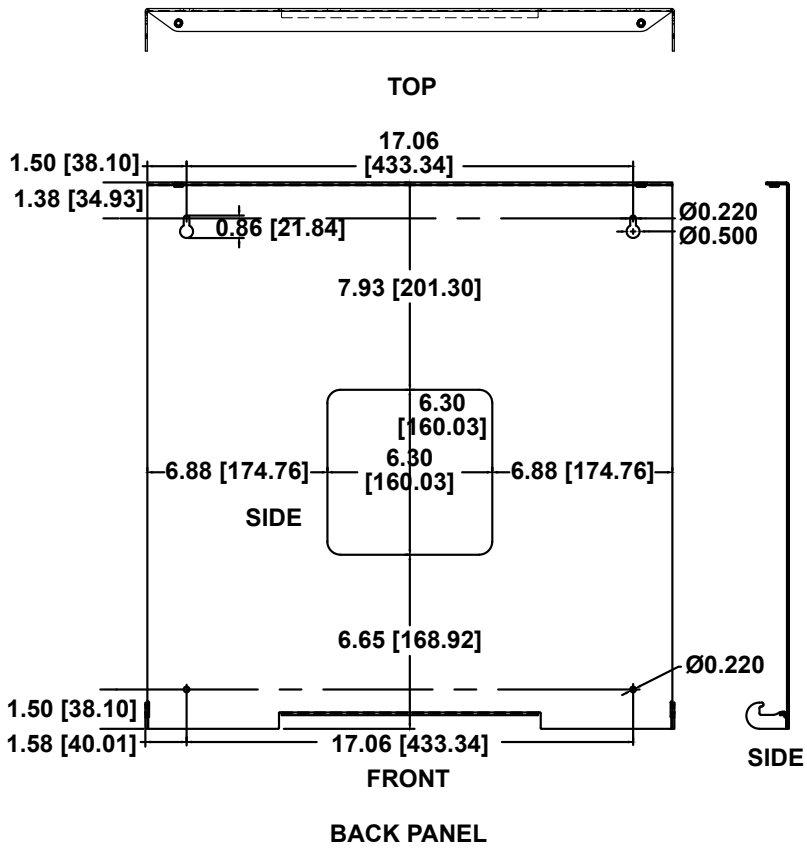
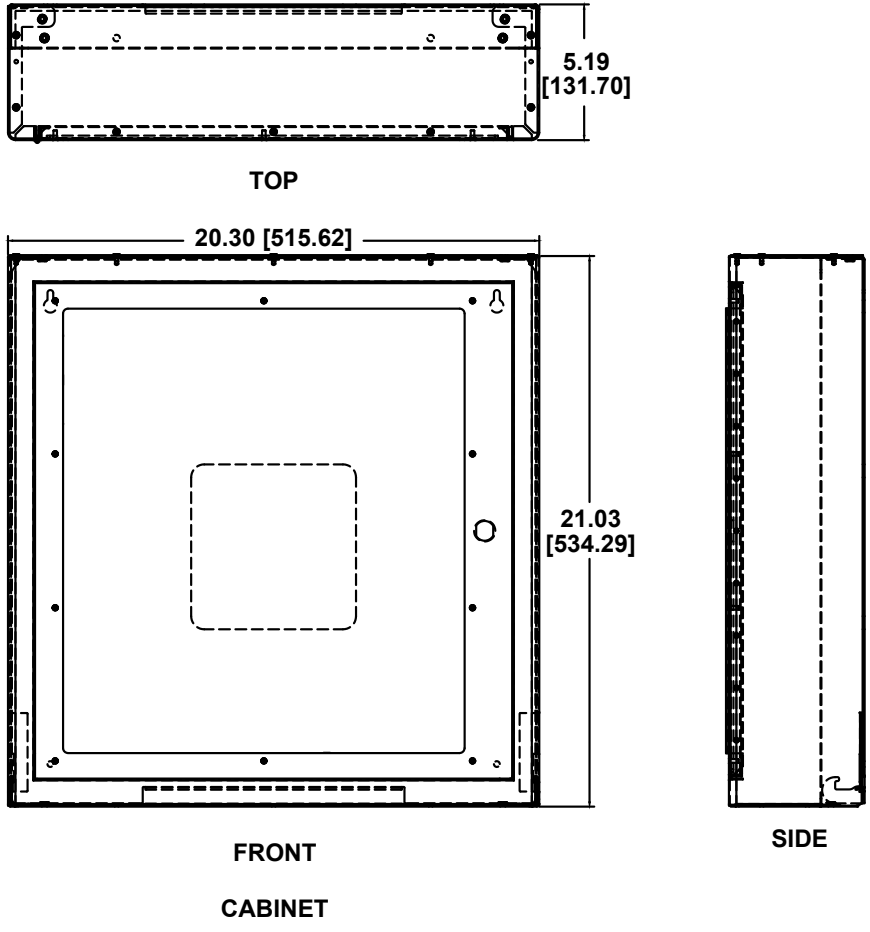

2500-28RCF, 2500-36RCF 2500-56XRCF, 2500-76XRCF, 2500-96XRCF, 2500-116XRCF

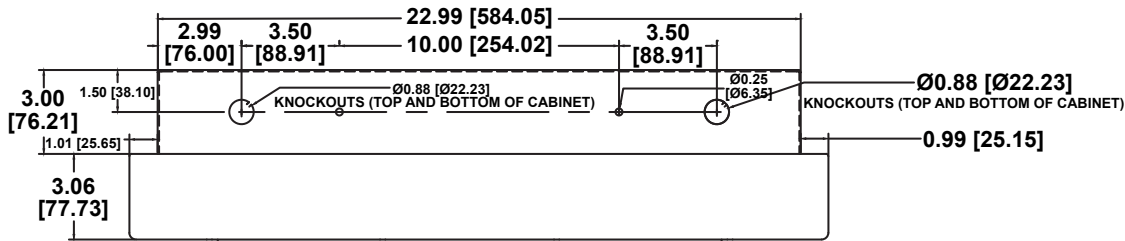

TOP

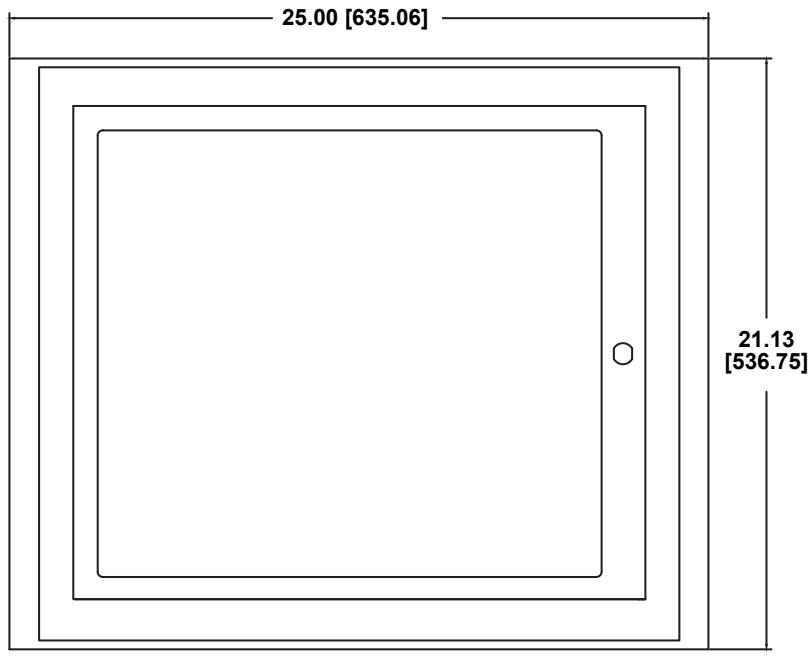

FRONT

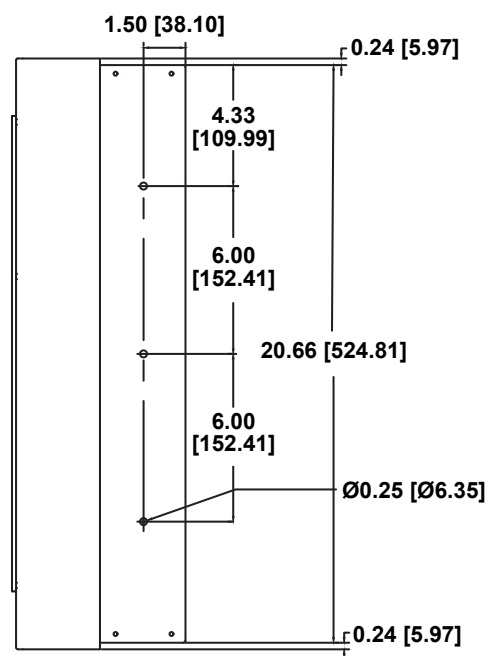

SIDE

Distribution Module Mounting (Command System Only)

1-36 Zone (PE) Distribution Module

Option 1: Wall Mounting

- Use diagram as a guide for pre-drilling holes in wall
- Remove top panel and drill out keyholes for mounting
- Secure to wall with provided screws

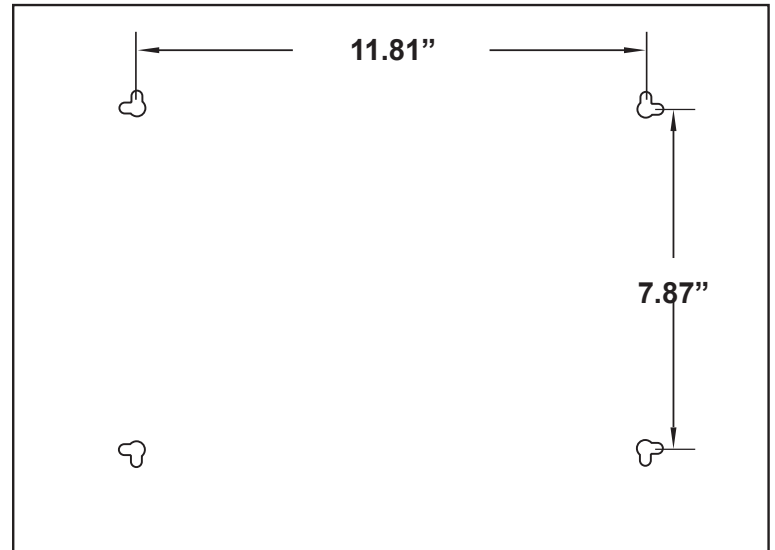

Option 2: Shelf Mounting (shelf not provided by RATH®)

- Place on shelf mounted in 19" server rack



1-116 Zone (GE)

Option 1: Wall Mounting

- Use diagram below to pre-drill holes into wall
- Secure screws in wall
- Attach Distribution Module to wall using the keyholes on backside

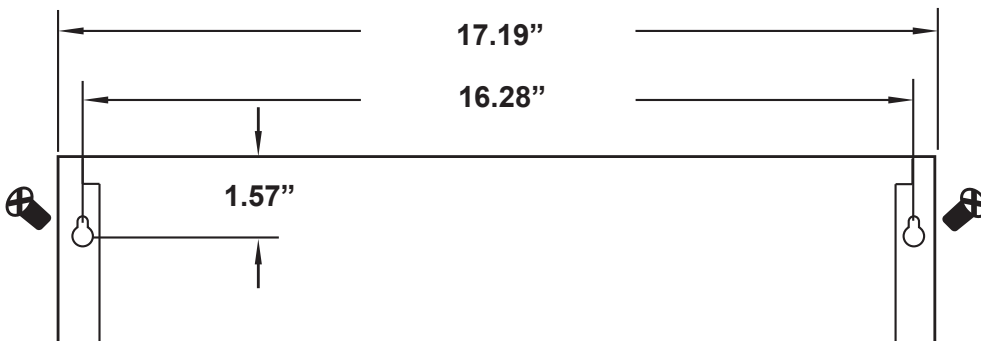

Option 2: Rack Mounting (rack not provided by RATH®)

- Attach included brackets to sides of Distribution Module
- Secure to 19" server rack using compatible machine screws for your rack



Option 3: Shelf Mounting (shelf not provided by RATH®)

- Place on open rack mounted shelf



Supervisor Board Mounting (2500-__SPRVSR)

Mount the 2500 Supervisor Board to a wall using the provided swing arm bracket or to a 19" rack (not included).

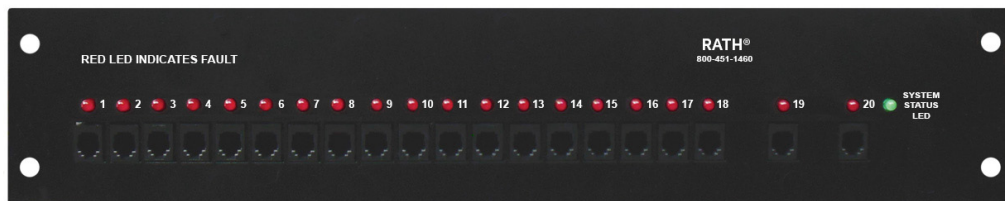

Signage Mounting

Instruction Sign

- Mount above or adjacent to each Call Box

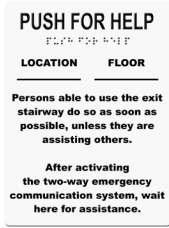

7049

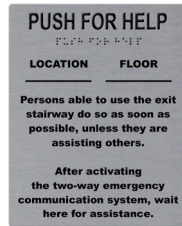

7049SS

Tactile/Braille Sign

- Mount between 48"-60" from floor to lowest tactile characters



7087



7044

Illuminated Sign

- 120/277vac powered
- Mount above 60" but below 80" from the floor to top of the sign
- Single gang back box recommended



7050E



7050

Photo Luminescent Sign

- Mount above 60" but below 80" from the floor to top of the sign



7041E



7041

Directional Signs

- Mount 48" from the floor to the bottom of the sign
- Located in hallway adjacent to Area of Refuge



7047E



7047

System Mounting Locations

In Elevator Landings:

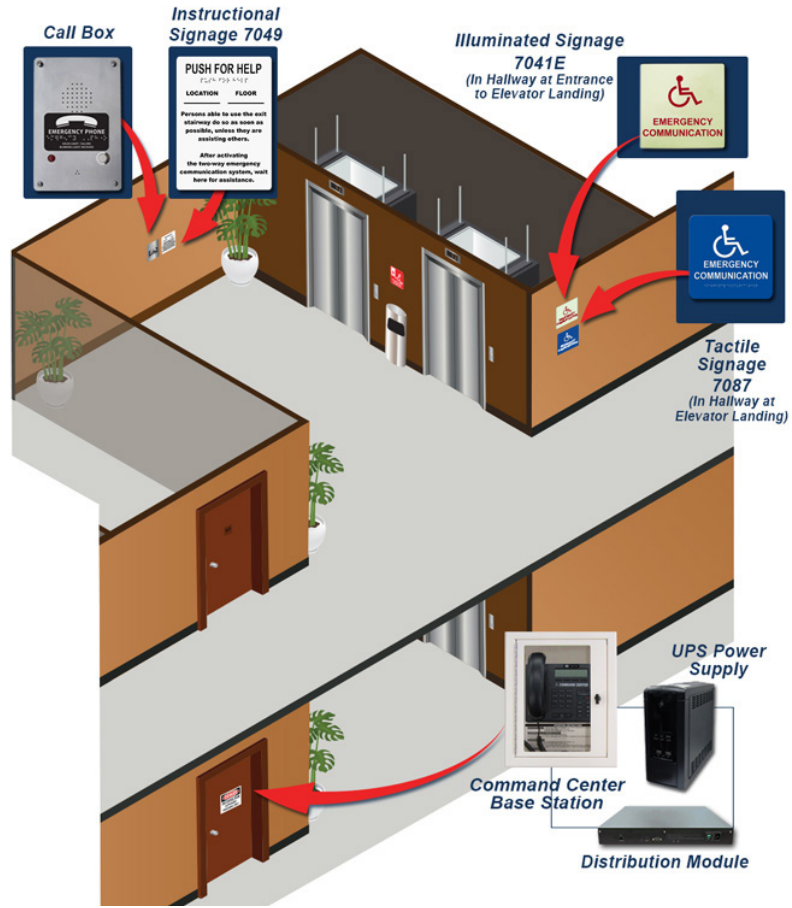

In Stairwells:

