

SDC Security Door Controls

801 Avenida Acaso, Camarillo, Ca. 93012 • (805) 494-0622 •
www.sdcsecurity.com • E-mail: service@sdsecurity.com



INSTALLATION INSTRUCTIONS 290 CABINET LOCK

The cabinet lock is designed to be installed into cabinets and lockers, etc., with either swing or sliding doors. The lock is supplied in the "FAIL SECURE/POWER TO OPEN" configuration as the initial factory setting.

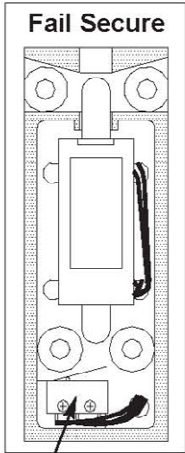

CHANGING LOCK MODE OF OPERATION

Fail Secure to Fail Safe:

1. Remove the two rear solenoid screws.
2. Reverse solenoid position.
3. Secure solenoid and replace wire in opposite hole.

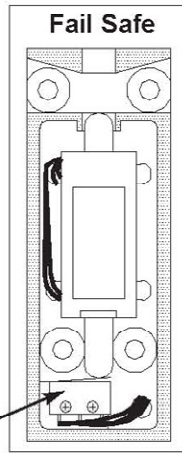

Lock status sensor is optional

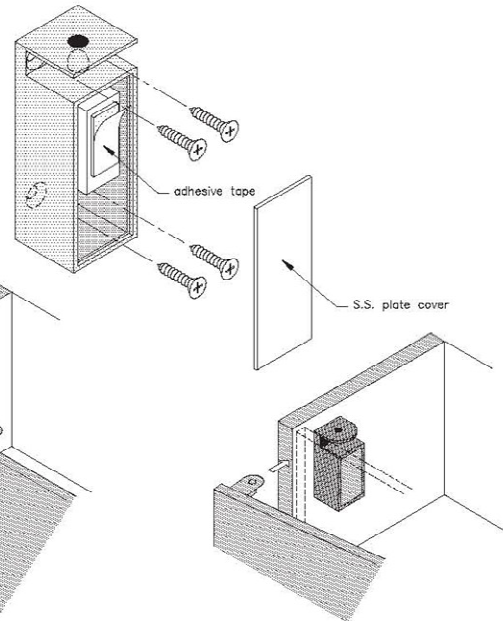
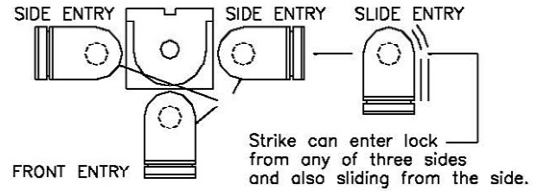

ELECTRICAL SPECIFICATION: Dual Voltage - 300/150 mA@ 12/24VDC

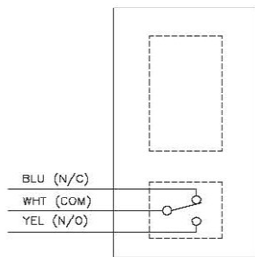

LOCK STATUS SWITCH FOR FAIL SECURE

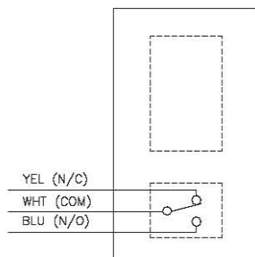

LOCK STATUS SWITCH FOR FAIL SAFE

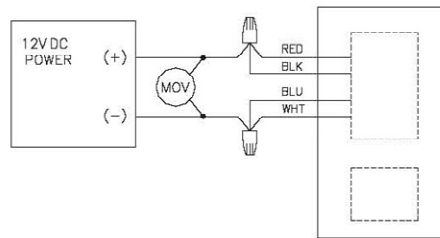

SOLENOID WIRING FOR 12VDC

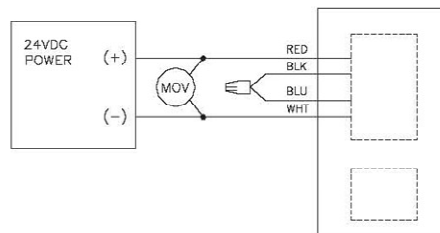

SOLENOID WIRING FOR 24VDC

**290 CABINET LOCK
MOUNTING TEMPLATE**

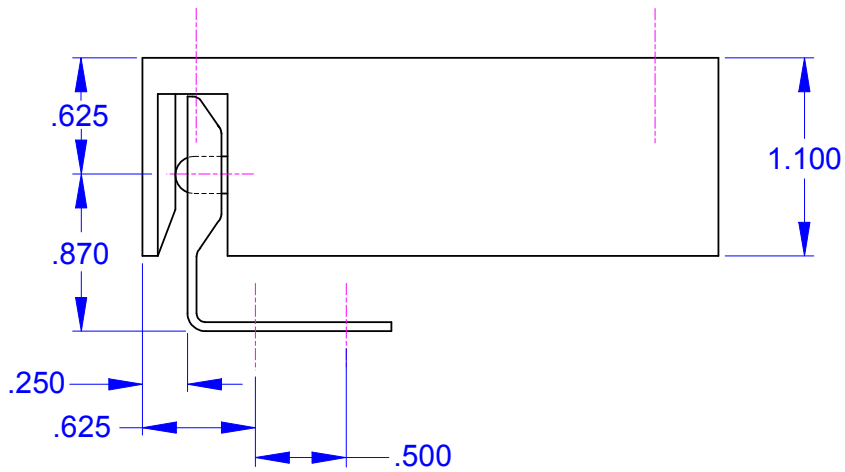
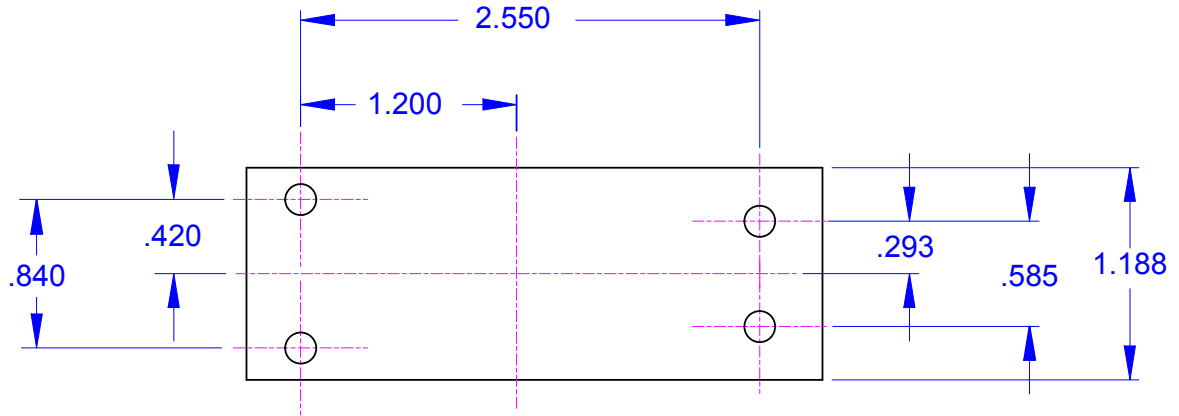

DRAWING MAY NOT BE TO SCALE.
USE DIMENSIONAL CALL-OUTS ONLY.