



SCM268

Four-Channel Microphone Mixer

The Shure four-channel microphone mixer, SCM268, user guide.
Version: 5.2 (2022-1)

Table of Contents

SCM268 Four-Channel Microphone Mixer	3	Installation	8
IMPORTANT SAFETY INSTRUCTIONS	3	Supplied Hardware	8
General Description	4	Rackmount Installation	9
Features	4	Internal Modifications	11
Front Panel	4	Internal Modifications	11
Rear Panel	5	Disassembly	11
Gain Control	6	Low-Cut Filter	12
Input Gain	6	Phantom Power Disable	13
Output Gain	6	Line Pad	13
Output Level Meter	6	Hot Mic Pad	13
Phantom Power	6	Specifications	14
Output Level Switch	7	Optional Accessories and Replacement Parts	15
Connections	7	Optional Accessories	15
		Replacement Parts	15
		Certifications	15

SCM268

Four-Channel Microphone Mixer

IMPORTANT SAFETY INSTRUCTIONS

1. READ these instructions.
2. KEEP these instructions.
3. HEED all warnings.
4. FOLLOW all instructions.
5. DO NOT use this apparatus near water.
6. CLEAN ONLY with dry cloth.
7. DO NOT block any ventilation openings. Allow sufficient distances for adequate ventilation and install in accordance with the manufacturer's instructions.
8. DO NOT install near any heat sources such as open flames, radiators, heat registers, stoves, or other apparatus (including amplifiers) that produce heat. Do not place any open flame sources on the product.
9. DO NOT defeat the safety purpose of the polarized or grounding type plug. A polarized plug has two blades with one wider than the other. A grounding type plug has two blades and a third grounding prong. The wider blade or the third prong are provided for your safety. If the provided plug does not fit into your outlet, consult an electrician for replacement of the obsolete outlet.
10. PROTECT the power cord from being walked on or pinched, particularly at plugs, convenience receptacles, and the point where they exit from the apparatus.
11. ONLY USE attachments/accessories specified by the manufacturer.
12. USE only with a cart, stand, tripod, bracket, or table specified by the manufacturer, or sold with the apparatus. When a cart is used, use caution when moving the cart/apparatus combination to avoid injury from tip-over.



13. UNPLUG this apparatus during lightning storms or when unused for long periods of time.
14. REFER all servicing to qualified service personnel. Servicing is required when the apparatus has been damaged in any way, such as power supply cord or plug is damaged, liquid has been spilled or objects have fallen into the apparatus, the apparatus has been exposed to rain or moisture, does not operate normally, or has been dropped.
15. DO NOT expose the apparatus to dripping and splashing. DO NOT put objects filled with liquids, such as vases, on the apparatus.
16. The MAINS plug or an appliance coupler shall remain readily operable.
17. The airborne noise of the Apparatus does not exceed 70dB (A).
18. Apparatus with CLASS I construction shall be connected to a MAINS socket outlet with a protective earthing connection.
19. To reduce the risk of fire or electric shock, do not expose this apparatus to rain or moisture.
20. Do not attempt to modify this product. Doing so could result in personal injury and/or product failure.
21. Operate this product within its specified operating temperature range.



This symbol indicates that dangerous voltage constituting a risk of electric shock is present within this unit.



This symbol indicates that there are important operating and maintenance instructions in the literature accompanying this unit.

WARNING: Voltages in this equipment are hazardous to life. No user-serviceable parts inside. Refer all servicing to qualified service personnel. The safety certifications do not apply when the operating voltage is changed from the factory setting.

General Description

The Shure Model SCM268 is a transformer-balanced, four-channel microphone mixer. Its simple, compact design delivers superior performance and exceptional sound quality with low noise and a flat frequency response.

Versatile in all types of applications, the SCM268 integrates transformer-balanced XLR inputs, a switchable microphone/line level transformer-balanced XLR output, phono jack inputs and output, phantom power, and an auxiliary input channel. It can function as a primary or add-on mixer for sound reinforcement, recording, broadcast, or audio-visual presentation systems.

With the supplied hardware, the mixer's half-rack chassis mounts securely in single or dual rackmount installations. For fixed installations, the SCM268 can be fastened on or below a shelf, counter, or tabletop.

Features

- Four transformer-balanced microphone inputs
- Transformer-balanced output-switchable mic/line level
- Five -10 dB line-level inputs
- Six-segment LED output level meter
- Built-in 12-volt phantom power
- Internal power transformer
- Built-in low-cut filter on microphone inputs (below 80 Hz)

Front Panel

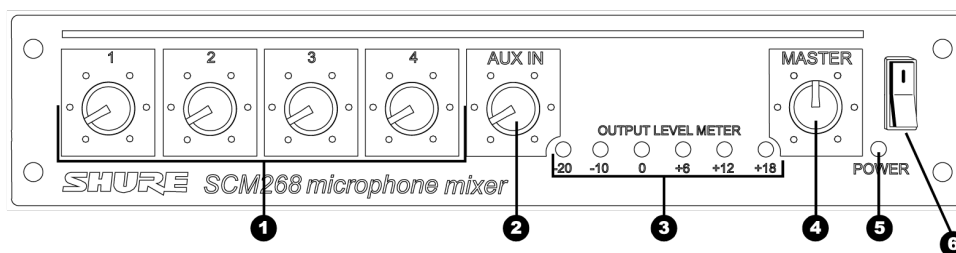

① Gain Controls (1-4).

Adjusts gain for microphone level inputs and auxiliary level inputs 1-4.

② Auxiliary Channel Gain Control (AUX IN).

Adjusts the auxiliary channel input gain.

③ Output Meter.

LED meter indicates peak output signal level.

④ Master Gain Control (MASTER).

Adjusts overall output level.

⑤ Power Indicator (POWER).

This LED illuminates when the unit is plugged in and receiving power.

The SCM268 does not have a power switch. To turn the unit off, unplug the power cord or use an external power strip with a switch. However, it can remain plugged in as it uses very little power when idle.

⑥ POWER Switch

Country dependent.

Rear Panel

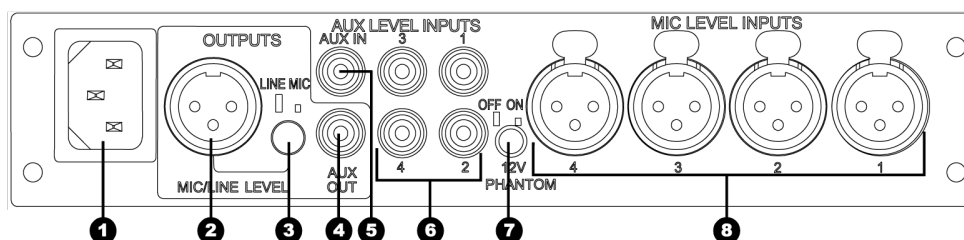

① Power Connector.

Accepts 100-120 Vac (SCM268) or 220-240 Vac (SCM268E).

② Output Connector (MIC/LINE OUT).

Transformer-balanced XLR output connector. Switchable between line and microphone level.

③ Output Level Switch (MIC/LINE OUT).

Recessed switch changes the signal level of the XLR output connector: In = Microphone Level. Out = Line Level.

④ Auxiliary Output Connector (AUX OUT).

RCA output feeds consumer-level audio equipment. Not affected by MIC/LINE switch.

⑤ Auxiliary Input Channel (AUX IN).

A dedicated auxiliary-level input for the auxiliary channel.

⑥ Auxiliary Level Inputs (AUX LEVEL INPUTS, 1-4).

RCA inputs connect to consumer-level audio sources.

⑦ Phantom Power Switch (12V PHANTOM).

Recessed switch turns on phantom power for microphone inputs 1-4.

⑧ Microphone Level Inputs (MIC LEVEL INPUTS).

Transformer-balanced, microphone-level XLR inputs.

Gain Control

Input Gain

The gain control knobs 1-4, located on the front panel, adjust the gain for both microphone and auxiliary-level inputs of channels 1-4 (see Figure1). For example, the channel 1 gain control is used for both the channel 1 microphone input (MIC LEVEL INPUT 1) and the channel 1 auxiliary level input (AUX LEVEL INPUT 1). The auxiliary gain control knob (AUX IN) affects only the auxiliary input (AUX IN).

Output Gain

The master output gain control knob (MASTER) adjusts gain to both the XLR balanced output (MIC/LINE LEVEL) and the auxiliary level output (AUX LEVEL).

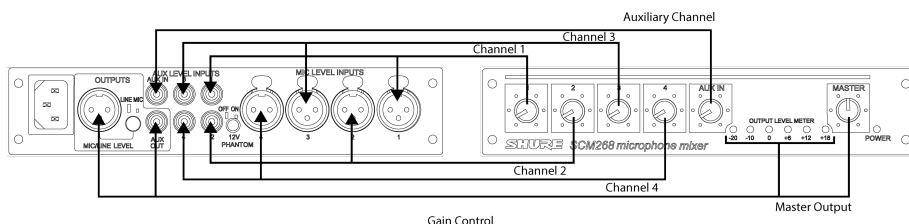
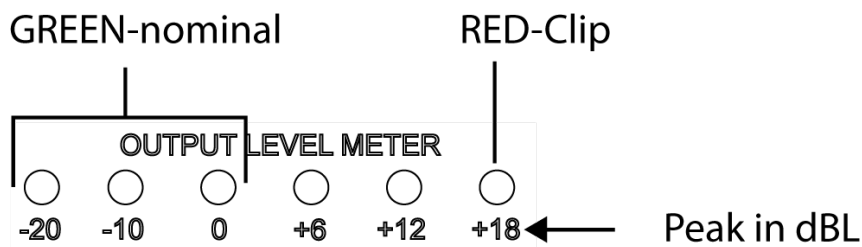

Figure 1

Output Level Meter

The six LEDs on the front panel labeled OUTPUT LEVEL METER illuminate to reflect the peak level of the mixed output signal from the SCM268 (in reference to balanced line output) in dBu (0 dBu = 0.775 V).

Use the master gain control (MASTER) to adjust peak levels, as indicated by the LEDs. The red LED illuminates when the output is 2 dB below clipping.



Phantom Power

When the phantom power switch on the back panel is on (12V PHANTOM-ON), the SCM268 provides 12 V of phantom power to each XLR microphone input. The switch is recessed to prevent accidental engagement. Most condenser microphones require phantom power. Use it when connecting these types of microphones to the SCM268.

Phantom power does not affect the operation of balanced dynamic microphones. With phantom power on, they can be connected to the SCM268 in combination with condenser microphones that do use it.

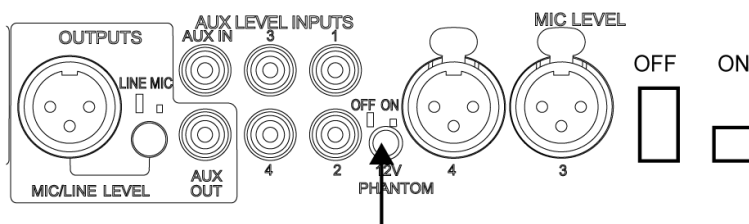

Phantom Power Switch

Output Level Switch

The output level switch on the back panel (MIC/LINE OUT) sets the level of the balanced XLR output. When set to MIC, it reduces the output by about 50 dB. Set the switch so that the output level matches the input level of the device to which you are connecting the SCM268. The switch is recessed to prevent accidental engagement.

The output level switch does not affect the auxiliary output (AUX OUT) level.

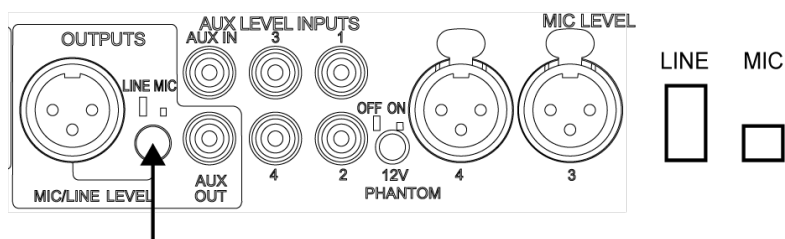

Output Level Switch

Connections

The following diagram illustrates a few of the many types of connections possible with the SCM268. Note that nothing is connected to the channel 4 microphone input (MIC LEVEL INPUT 4). This is because channel 4 is being used for the consumer-level equipment connected to the channel 4 auxiliary level input (AUX LEVEL INPUT 4). Connecting both auxiliary level and mi-

crophone level inputs to a single channel is not recommended because the SCM268 would not be able to independently mix the two sources.

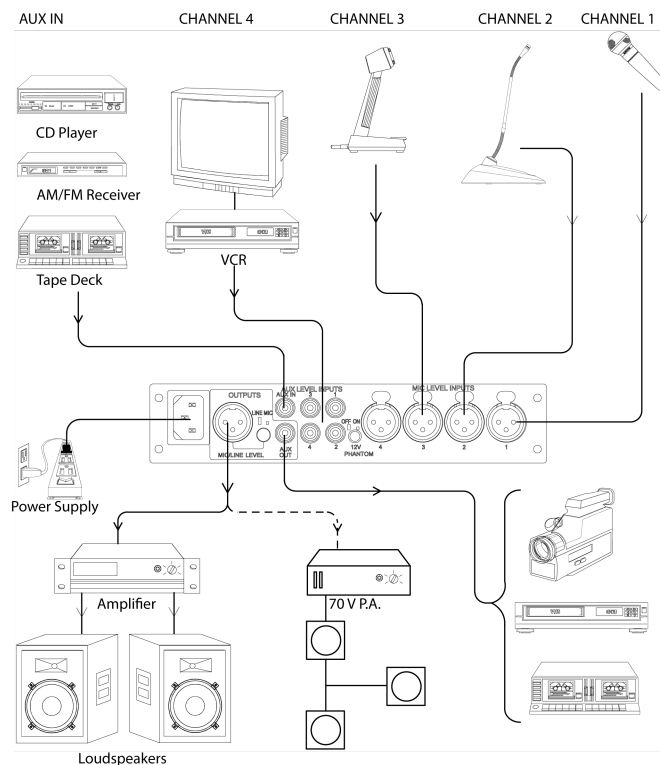

Installation

Supplied Hardware

- 4 rubber feet. For stand-alone installation.
- 1 rackmount bracket, long. For half-rack (single unit) installations.
- 1 rackmount bracket, short. For half-rack (single) or dual-mount installations.
- 2 straddle brackets. For dual-mount or fixed installations.
- 12 bracket screws, 1/4 in. (6 mm). For securing the brackets to the chassis.
- 4 rackmount screws, 1 in. (2.5 cm). For mounting the unit in a rack.
- 4 plastic washers. For use with the supplied rackmount screws.
- 4 wood screws, 1/2 in. (1.25 cm). For fixed installations.



Rackmount Installation

The SCM268 can be mounted as a single unit or dual-mounted with either another SCM268 or another Shure half-rack unit such as the SCM262 or DFR11EQ. Attach the rackmount brackets using one of the following methods:

Single-unit (half-rack) installation:

1. Attach the short and long rackmount brackets to the SCM268 with eight (8) of the supplied bracket screws.

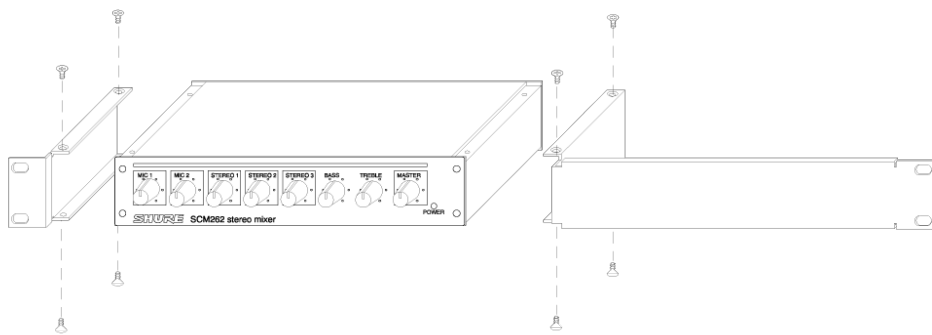

Dual-mounted installation:

1. Connect the two units together side-by-side using two (2) straddle brackets. The brackets should straddle the recessed edges on the top and bottom of each chassis. Fasten them using eight (8) bracket screws.

Be sure to use both straddle brackets—one on the top and one on the bottom.

2. Attach the short rackmount brackets to the outsides of the combined units with eight (8) of the bracket screws.

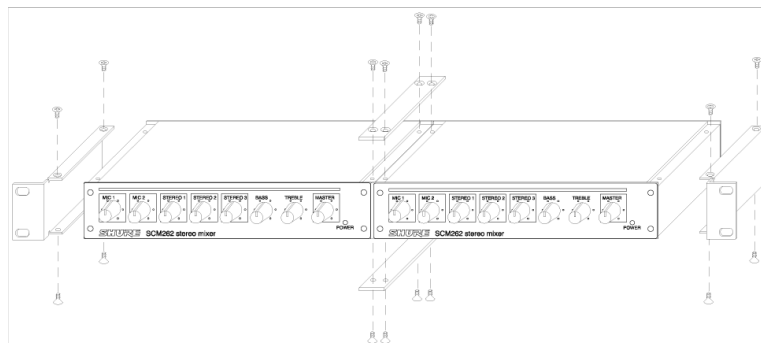

- After attaching the brackets, mount the unit in an equipment rack using the supplied rackmount screws and plastic washers.

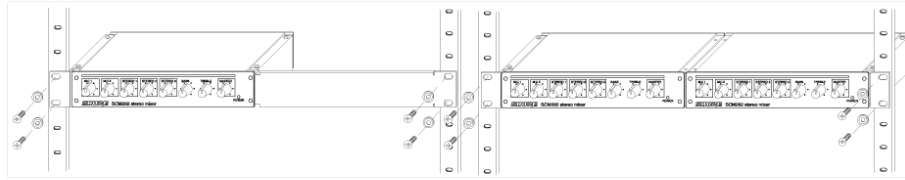

Stand-Alone Installation

Adhere the four (4) supplied rubber feet to the bottom of the unit at each corner. This will keep it from sliding and protect the table surface.

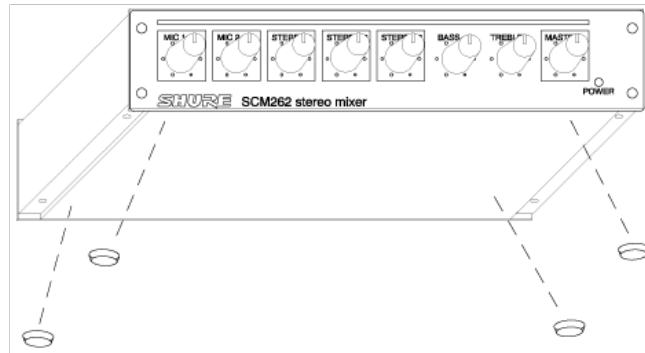

Fixed Installation

To permanently affix the SCM268 above or below a table, shelf, or counter top, use the following steps:

- Fasten the straddle brackets to the recessed edges of the chassis using four (4) bracket screws.
 - Top mount:** Fasten the straddle brackets to the bottom of the unit.
 - Hanging mount:** Fasten the straddle brackets to the top of the unit.
- Fasten the straddle brackets to the surface using the four (4) supplied wood screws.

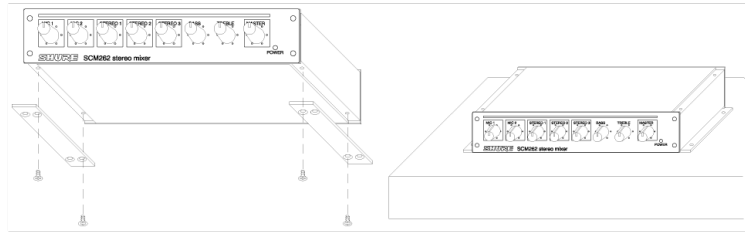

Top Mount

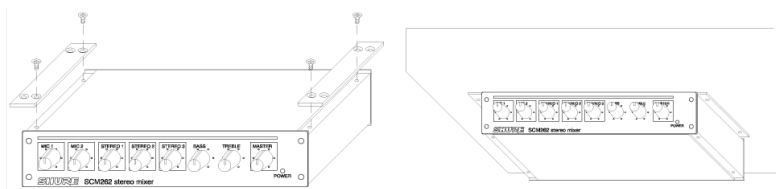

Hanging Mount

Internal Modifications

Internal Modifications

Voltages in this equipment are hazardous to life. No user-serviceable parts inside. Refer all servicing and modifications to qualified service personnel.

Disassembly

To access the printed circuit board (pc board) for internal modifications, use the following steps:

1. Unplug the power cord.
2. Remove the knobs and retainer nuts from the front panel (See figure 2).

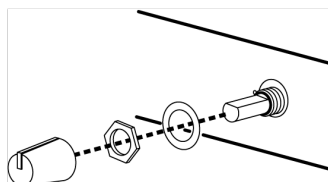

Knob Assembly

FIGURE 2

3. Remove the four screws at each corner of the back panel.
4. Remove the two screws at each bottom corner of the front panel.
5. Slide the back panel and pc board out from the rear of the chassis.

When reassembling the SCM268, DO NOT OVERTIGHTEN the knob retainer nuts. Use a minimal amount of force to secure the nut (0.6-0.8 N m (5-7 in lb)). Damage to the internal components will result if too much force is used.

Low-Cut Filter

To bypass the built-in low-cut filter for a given channel, remove the specified resistor and place a 10 μ F to 33 μ F capacitor in the specified pc board location (polarity does not matter). Refer to the following table:

Channel	Remove Resistor from:	Place 0 μ F to 33 μ F Capacitor in:
1	R18	X17
2	R28	X27
3	R38	X37
4	R48	X47

To select a particular corner frequency for the low cut filter, remove the R18, R28, R38, or R48 resistor for a given channel as specified above. Then, in the corresponding pc board location (X17, X27, X37, or X47), place a capacitor of the specified value (polarity does not matter). Refer to the following formula for selecting the correct capacitor value for the desired corner frequency.

$$C = 26.5/F$$

where:

C = value of capacitor in μ F

F = corner frequency (-3 dB) for low-cut filter in Hz

The following table lists the low-cut frequency corners for some of the most common capacitor values:

Capacitor Value (μ F)	Low-Cut Frequency Corner (Hz)
.033	803
.047	564
.068	390
.1	265
.22	120
.33	80
.47	56
.68	39
1.0	26.5
2.2	12

Phantom Power Disable

To disable phantom power for a given microphone input, remove the specified resistor as listed in the following table:

Channel	Remove Resistor:
1	R15
2	R25
3	R35
4	R45

Line Pad

To insert a 50 dB line pad for a given microphone input, remove the specified resistor and short the solder points at the specified pc board locations. Refer to the following table:

Channel	Remove Resistors:	Short Solder Points:
1	R12, R13, R15	X11 and X14
2	R22, R23, R25	X21 and X24
3	R32, R33, R35	X31 and X34
4	R42, R43, R45	X41 and X44

Hot Mic Pad

Some condenser mics have a high output. In order to avoid overdriving the input stage, the user may need to set the input pot lower than desired. To fix this problem, the user can place an 11 dB pad into the input gain stage of a selected channel.

1. Twist together the leads from one side of a 15 k Ω resistor and a 0.1 μ F capacitor:

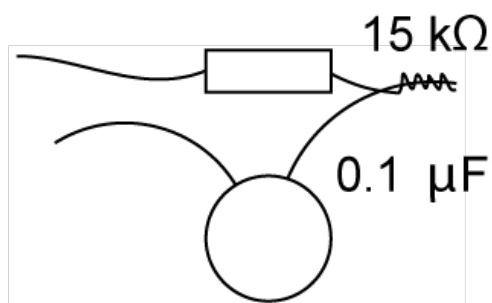

2. Solder the free ends of the resistor-capacitor combination into the holes at the jumper position indicated by the following table and remove the corresponding surface mount resistor.

Channel	Remove Resistor	Insert Resistor-Capacitor Combination at Jumper
1	R18	X17

Channel	Remove Resistor	Insert Resistor-Capacitor Combination at Jumper
2	R28	X27
3	R38	X37
4	R48	X47

Specifications

Frequency Response

at 1 kHz

Mic/Line Switch	150 Hz to 20 kHz ± 2 dB
Aux Input	20 Hz to 20 kHz ± 2 dB

Low-Cut Filter

-6 dB/octave below 80 Hz

Total Harmonic Distortion

1 kHz, +4 dBu out, mix output (MASTER) at +0 dB

<0.25%

Equivalent Input Noise

150 Ω balanced source, A-Weighted

-130 dBV

Output Noise

channel controls full counterclockwise, A-Weighted

Master full counterclockwise	-107 dBV
Master full clockwise	-73 dBV

Common Mode Rejection

>80 dB, at 1 kHz

Polarity

All inputs to all outputs are non-inverting.

Overload and Shorting Protection

Shorting outputs, even for prolonged periods, causes no damage. Microphone inputs are not damaged by signals up to +10 dBV; Line and Aux inputs by signals up to +28 dBV

Phantom Power

12 Vdc open-circuit through 680 Ω resistors

Operating Voltage

SCM268	100–200 V AC, 50/60 Hz, 60 mA
SCM268E	220–240 V AC, 50/60 Hz, 30 mA

Temperature Range

Operating Temperature	-7° – 35° C (20° –95° F)
Storage Temperature	-29° – 74° C (-20° –165° F)

Dimensions

44 x 218 x 162 mm (1.72 x 8.60 x 6.37 in.)

Net Weight

1.20 kg (2 lbs, 10 oz.)

Optional Accessories and Replacement Parts

Optional Accessories

Line (Power) Cord, 230-240 Vac (UK)	95A8713
--	---------

Replacement Parts

Knob, Master (blue)	95B8752
Knob, Channel Gain (white)	95A8752
Line (Power) Cords: SCM268: 100-120 Vac (US/Canada)	95A8762
Line (Power) Cords: SCM268E: 220-240 Vac (EU)	95A8778
Fuse, SCM268 (5x20 mm, 250V, 80mA, slow-blow)	80A730
Fuse, SCM268E (5x20 mm, 250V, 40mA, slow-blow)	80J258
Hardware Kit	90AW8100
Link Bars (Bracket)	53B8443
Single Mount Bracket	53A8484
Dual Mount Bracket	53E8484

Certifications

This product meets the Essential Requirements of all relevant European directives and is eligible for CE marking.

The CE Declaration of Conformity can be obtained from: www.shure.com/europe/compliance

Authorized European representative:
Shure Europe GmbH
Headquarters Europe, Middle East & Africa
Department: EMEA Approval
Jakob-Dieffenbacher-Str. 12
75031 Eppingen, Germany
Phone: +49-7262-92 49 0
Fax: +49-7262-92 49 11 4
Email: info@shure.de